

PROCEEDINGS

ARCC

The Architectural Research Centers Consortium (ARCC) is an international association of architectural research centers, academies and organizations committed to the research culture and supporting infrastructure of architecture and related design disciplines. Through conference programming, grant and award programs, workshops, and research journal ENQ, ARCC represents a concerted commitment to improve the quality of life in the built environment.

> <https://www.arcc-arch.org>

EAAE

The European Association for Architectural Education (EAAE) is an international, membership-based Association organizing architectural schools in Europe. The purpose of the Association is to advance the quality of architectural education and to promote the quality of architecture in Europe. The Association provides a forum for generating information on aspects of architectural education and architectural research.

> <https://www.eaae.be>

DIGITAL VERSION

Best to read Proceedings as a two-page spread in Acrobat

In Acrobat, go to: View > Page Display > Two Page View

Proceedings of the ARCC-EAAE 2022 International Conference
Architectural Research Centers Consortium / European Association for Architectural Education
RESILIENT CITY: Physical, Social, and Economic Perspectives

Editors: Chris Jarrett, Adil Sharag-Eldin

Publisher: Architectural Research Centers Consortium, Inc.

ISBN 978-1-935129-31-8

© 2022 Architectural Research Centers Consortium, Inc. All rights reserved. No part of this book may be reproduced in any manner whatsoever without prior written permission from the publisher.



The Architectural Research Centers Consortium (ARCC) in partnership with the
European Association for Architectural Education (EAAE)

RESILIENT CITY

Physical, Social, and Economic Perspectives



ARCC-EAAE 2022 International Conference
Florida International University, Miami, FL



March 2-5, 2022
May 23, 2022: Virtual Session

Conference Co-Chairs
Marilys Nepomechie
Shahin Vassigh

Editors
Chris Jarrett
Adil Sharag-Eldin

TABLE OF CONTENTS

i	CONFERENCE LEADERSHIP AND ADMINISTRATION
ii	PAST CONFERENCES AND ARCC MEMBERSHIP
iii-vi	CONFERENCE PEER REVIEW COMMITTEE Two-Stage Double-Blind Peer Review
vii-viii	CONFERENCE THEME Marilys Nepomechie and Shahin Vassigh Florida International University
ix-xii	KEYNOTE SPEAKERS Philippe Block, ETH Zurich and Block Research Group Susannah Drake, DLANDstudio, New York Toni Griffin, Harvard University, urbanAC James Murley, Chief Resilience Officer, Miami-Dade County Jeremy Till. University of the Arts, London
xiii-xxiv	LIST OF RESEARCH PAPERS AND POSTERS
1-776	ARCC-EAAE 2022 RESEARCH PAPERS
777-796	ARCC-EAAE 2022 RESEARCH POSTER ABSTRACTS
797-798	BEST PAPER AND BEST POSTER AWARDS

ARCC-EAAE 2022 INTERNATIONAL CONFERENCE COMMITTEE

Conference Co-Chairs

Marilys Nepomechie, Florida International University
Shahin Vassigh, Florida International University

Conference Leadership + Advisory Committee

ARCC: Chris Jarrett, President
Adil Sharag-Eldin, Vice-President/President-Elect
EAAE: Oya Atalay, President
Ilaria Valente, Vice-President

Conference Topic Chairs: Florida International University

Biayna Bogosian, Co-Chair, Technology
Jason Chandler, Co-Chair, Climate
Newton D'souza, Co-Chair, Public Health
Neal Leach, Chair, Doctoral Education
Magda Mostafa, Co-Chair, Public Health
Eric Peterson, Co-Chair, Technology
Gray Read, Co-Chair, Equity
Roberto Rovira, Co-Chair, Climate
Elisa Silva, Co-Chair, Equity

Session Moderators

Tristan Al-Haddad, Formations Studio	Chris Jarrett, University of North Carolina at Charlotte
Ahmed Ali, Texas A&M University	Elizabeth McCormick, University of North Carolina at Charlotte
Oya Atalay, Zurich University of Applied Sciences	Taraneh Meshkani, Kent State University
Rahman Azari, Pennsylvania State University	Valerian Miranda, Texas A&M University
Ezgi Bay, University of Utah	Teresa Fotini Moroseos, University of Washington
Christina Bollo, University of Illinois Urbana-Champaign	Ana Tricarico Orosco, Florida A&M University
Dag Boutsen, Katholieke Universiteit Leuven	Claus Peder Pedersen, Arkitektskolen Aarhus
Elizabeth Marie Cronin, University of Florida	Hazem Rashed-Ali, Texas Tech University
Lyndsey Deaton, University of Oregon	Traci Rider, North Carolina State University
Rachel Dickey, University of North Carolina at Charlotte	Jessica Rossi-Mastracci, University of Minnesota
Ihab Elzeyadi, University of Oregon	Adil Sharag-Eldin, Kent State University
Niloufar Emami, University of Illinois Urbana-Champaign	Alexandra Staub, Pennsylvania State University
Jori Erdman, James Madison University	Ilaria Valente, Politecnico di Milano
Sarah Gamble, University of Florida	Peter Wong, University of North Carolina at Charlotte
Saif Haq, Texas Tech University	Chengde Wu, Iowa State University
Adele Houghton, Harvard University	Joao Pedro Xavier, University of Porto
Ming Hu, University of Maryland	Tadeja Zupančič, University of Ljubljana

*Special thanks to students Ethan Rhodes and Vamsi Kamatham for their administrative support of the Conference.

ARCC BOARD OF DIRECTORS (2021-2022)

Officers

Chris Jarrett, President, University of North Carolina at Charlotte
Adil Sharag-Eldin, Vice-President/President-Elect, Kent State University
Saif Haq, Treasurer, Texas Tech University
Alexandra Staub, Secretary, Pennsylvania State University
Hazem Rashed-Ali, Past-President, Texas Tech University

At-Large Members

Christina Bollo, University of Illinois at Urbana-Champaign
Ihab Elzeyadi, University of Oregon
Ming Hu, University of Maryland
Clare Robinson, University of Arizona

X-Officio Members

Rahman Azari, Pennsylvania State University
Valerian Miranda, Texas A&M University
Philip Plowright, Lawrence Technological University
Brian Sinclair, University of Calgary
Virginia Ebbert, American Institute of Architects

ARCC Past Conferences

Paris_2000 EAAE-ARCC International Conference
Blacksburg_2001 ARCC Conference
Montreal_2002 ARCC-EAAE International Conference
Tempe_2003 ARCC Conference
Dublin_2004 EAAE-ARCC International Conference
Jackson_2005 ARCC Conference
Philadelphia_2006 ARCC-EAAE International Conference
Eugene_2007 ARCC Conference
Copenhagen_2008 EAAE-ARCC International Conference
San Antonio_2009 ARCC Conference
Washington DC_2010 ARCC-EAAE International Conference
Detroit_2011 ARCC Conference

Milan_2012 EAAE-ARCC International Conference
Charlotte_2013 ARCC Conference
Honolulu_2014 ARCC-EAAE International Conference
Chicago_2015 ARCC Conference
Lisbon_2016 EAAE-ARCC International Conference
Salt Lake City_2017 ARCC Conference
Philadelphia_2018 ARCC-EAAE International Conference
Toronto_2019 ARCC International Conference
Valencia_2020 EAAE-ARCC International Conference
Tucson_2021 ARCC International Conference

ARCC Member Institutions (2021-2022)

American Institute of Architects
Arizona State University
Auburn University
Ball State University
Ball State University (CERES)
California Baptist University
California College of the Arts
California Polytechnic State University
Catholic University of America
Clemson University
Drexel University
Florida Atlantic University
Florida A&M University
Florida Atlantic University
Florida International University
Georgia Institute of Technology
IE School of Architecture and Design
Illinois Institute of Technology
Iowa State University
Kansas State University
Kennesaw State University
Kent State University
Laurentian University
Lawrence Technological University
Louisiana State University
McGill University
Miami University
Mississippi State University
Montana State University
New York Institute of Technology
North Carolina State University
Northeastern University
Norwich University
Oklahoma State University
Pennsylvania State University
Pratt Institute
Qatar University
Rensselaer Polytechnic Institute
Rochester Institute of Technology
Ryerson University

South Dakota State University
Southern Illinois University
Temple University
Texas A&M University
Texas Tech University
Thomas Jefferson University
Universitat Liechtenstein
University of Arizona
University of Arkansas
University of Buffalo
University of Calgary
University of Florida
University of Hawaii Manoa
University of Houston
University of Idaho
University of Illinois at Urbana Champaign
University of Kansas
University of Manitoba
University of Maryland
University of Memphis
University of Michigan
University of Minnesota
University of Missouri
University of Nebraska-Lincoln
University of Nevada-Las Vegas
University of North Carolina at Charlotte
University of Oklahoma
University of Oregon
University of South Florida
University of Tennessee
University of Texas at Arlington
University of Texas at San Antonio
University of Toronto
University of Utah
University of Virginia
University of Washington
University of Waterloo
University of Wisconsin-Milwaukee
Virginia Polytechnic University
Washington State University

Individual Member
Luis Alberto Perez Irribarren
Victor Molina
Lubomir S. Popov

Conference Peer Review Committee

Agutter, James
University of Utah

Aksamija, Ajla
University of Massachusetts Amherst

Al-Haddad, Tristan
Formations Works

AL-Mohannadi, Asmaa
Qatar University

Alaqtum, Tasbeeh
University of Arizona

Altaweli, Rafah
University of Cincinnati

Anis, Manal
University of Illinois Urbana-Champaign

Arvayo-Ballesteros, Fernando
Universidad de Sonora, Mexico

Ashayeri, Mehdi
Southern Illinois University

Azari, Rahman
Pennsylvania State University

Balmer, Jeffrey
University of North Carolina at Charlotte

Bank, Lawrence
Georgia Institute of Technology

Baudoin, Genevieve
Kansas State University

Baweja, Vandana
University of Florida

Bay, Ezgi
University of Utah

Beltran, Liliana
Texas A&M University

Bernal, Sandra Maria
University of Arizona

Blouin, Vincent Yves-Marie
Clemson University

Bollo, Christina
University of Illinois

Brause, Caryn
University of Massachusetts Amherst

Cabrera I Fausto, Ivan
Universitat Politècnica de València, Spain

Caldwell, Damon Edward
Louisiana Tech University

Carver, Dwaine
University of Idaho

Chamel, Olivier
Florida A&M University

Chinellato, Enrico
Independent Researcher, Italy

Christenson, Mike
University of Minnesota

Clouse, Carey
University of Massachusetts Amherst

Coronado, Maria Camila
University of Oregon

Costanza, David
Cornell University

Crosson, Courtney
University of Arizona

Daniels-Akunekwe, Chika Chioma
University of Calgary

de Paula, Nathália
École de technologie supérieure (ÉTS), Canada

De Walsche, Johan
University of Antwerp, Belgium

Dearstyne Hoste, Benjamin
University of Arizona

Del Bo, Adalberto
Politecnico di Milano, Italy

Demers, Matthew
Barker Nestor Architects

Diarte, Julio
Pennsylvania State University

Dreifuss-Serrano, Dr. Cristina
Universidad de Lima, Peru

Du, Peng
Thomas Jefferson University

El Khafif, Mona
University of Virginia

Elvin, George
North Carolina State University

Esmaeili, Nooshin
University of Calgary

Faoro, Daniel
Lawrence Technological University

Farid Mohajer, Mahsa
University of Massachusetts Amherst

Gámez, Dr. José L.S.
University of North Carolina at Charlotte

Geraki, Stefania Palmyra
University of Illinois at Chicago

Ghaemi, Sara
BWS Architects

Golden, Saul
Ulster University

Gopalakrishnan, Dr. Srilalitha
Singapore ETH Centre, Singapore

Guzowski, Mary Margaret
University of Minnesota

Hablani, Chirag
Singapore University of Technology and Design

Haglund, Bruce
University of Idaho

Hanzelkova, Jessica Rachel
University of Waterloo, Canada

Haq, Saif
Texas Tech University

Harrington, J. Brooke
Temple University

Hashemi, Farzad
Pennsylvania State University

Hashim, Bushra
University of Calgary

Hayes, Richard
Central Michigan University

Hennebury, Deirdre
University of Michigan

Hollengreen, Laura Holden
University of Arizona

Houghton, Adele
Harvard University

Hu, Ming
University of Maryland

Idris, Abdou
Université de Djibouti, The Netherlands

Im, Ok-kyun
University of North Carolina at Charlotte

Imam, Salah
University of Calgary

Ingaramo, Roberta
Politecnico di Torino, Italy

Jaminet, Jean
Kent State University

Jarrett, Chris
University of North Carolina at Charlotte

Jimenez Aguilar, Diana Maria
Universidad de Sonora, Mexico

Jo, Soo Jeong
Louisiana State University

Kim, Kyounghee
University of North Carolina at Charlotte

Kio, Patricia Njideka
Texas A&M University

Klein, Lidia
University of North Carolina at Charlotte

Koester, Robert
Ball State University

Konbr, Usama Abdelnaby
Tanta University, Egypt

Laboy, Michelle M.
Northeastern University

Lyndsay, Eva
Streika Institute, United Kingdom

Liu, Rui
Kent State University

Liu, Xiaoyun
Politecnico di Milano, Italy

Lopez Barrera, Silvina
Mississippi State University

Louro, Margarida
Universidade de Lisboa, Portugal

Machry, Herminia
Georgia Institute of Technology

Mansy, Khaled
Oklahoma State University

Marks, Frederick
Salk Institute for Biological Studies

Martin-Malikian, Liz
Kennesaw State University

Mathur, Pegah
North Carolina State University

Mayer, Matan
IE University, Spain

McCormick, Elizabeth
University of North Carolina at Charlotte

McIntire, Russell
Thomas Jefferson University

McQuiston, Lauren
University of Virginia

Medvegy, Gabriella
University of Pécs, Hungary

Meek, Christopher
University of Washington

Miranda, Valerian
Texas A&M University

Mistur, Mark
Kent State University

Mohsenin, Mahsan
Florida A&M University

Montelli, Raffaella
University of Houston

Mozari, Milad
University of Utah

Mueller, Stephen
Texas Tech University

Murphy, Christina
Morgan State University

Myung, Junyoung
University of Illinois Urbana-Champaign

Naik, Niyati Sudhir
University of Oregon

Newman, Winifred
Clemson University

Ng, Tsz Yan
University of Michigan

O'Geen, Charles Joseph
Kendall College of Art and Design

Ogoli, David Mwale
California Baptist University

Orlowski, Edward Michael
Lawrence Technological University

Osayamen, Esosa
University of Massachusetts Amherst

Park, Jinoh
University of Tennessee

Parlac, Vera
New Jersey Institute of Technology

Parsaee, Dr. Mojtaba
Laval University, Canada

Penrose, Jon
Kent State University

Pires da Fonseca Dias da Fonseca, Maria Teresa
Universidade do Porto, Portugal

Plowright, Philip David
Lawrence Technological University

Poerschke, Ute
Pennsylvania State University

Pokol, Júlia
Budapest University of Technology and Economics,
Hungary

Poustinchi, Ebrahim
Kent State University

Ra, Seung Kyu
Oklahoma State University

Ragheb, Ash
Lawrence Technological University

Rastegar, Roja
University of Kansas

Ridwana, Iffat
University of Cincinnati

Robinson, Clare
University of Arizona

Rockwood, David
University of Hawaii at Manoa

Rossi-Mastracci, Jessica
University of Minnesota

Rügemer, Jörg
University of Utah

Sadiq Garcia, Fauzia
Temple University

Santos, João Rafael
Universidade de Lisboa, Portugal

Santus, Kevin
Politecnico di Milano, Italy

Sapone, Sara Anna
Politecnico di Milano, Italy

Schafer, George Jacob
Clemson University

Schultz, Anne-Catrin
Wentworth Institute of Technology

Serafim, Marcos
University of Arizona

Shall, Scott Gerald
Lawrence Technological University

Sharag-Eldin, Adil
Kent State University

Sherbakova, Larisa
Larisa Sherbakova Architecture

Sinclair, Brian Robert
University of Calgary, Canada

Soderberg Esper, Prof. Catherine
Texas Tech University

Spagnolo, Isabella
Politecnico di Milano, Italy

Staub, Alexandra
Pennsylvania State University

Taher, Mania Tahsina
University of Wisconsin-Milwaukee

Tariq, Tasneem
Pennsylvania State University

Thaddeus, David

University of North Carolina at Charlotte

Theisen, Tanner

Louisiana State University

Valzania, Giacomo

McGill University, Canada

Van Acker, Maarten

University of Antwerp, Belgium

Van de Riet, Keith

University of Kansas

Willoughby, William

Kent State University

Wingert-Playdon, Kate

Temple University

Wong, Daniel Kin Heng

Singapore University of Technology and Design

Wong, Peter

University of North Carolina at Charlotte

Wu, Chengde

Iowa State University

Yoon, Yeobeom

North Carolina State University

Yousif, Shermeen

Florida Atlantic University

Zekos, Erika

University of Massachusetts Amherst

Zhang, Catty Dan

University of North Carolina at Charlotte

ARCC-EAAE 2022 INTERNATIONAL CONFERENCE THEME

Conference Co-Chairs: Marilyns Nepomechie and Shahin Vassigh

RESILIENT CITY: Physical, Social, and Economic Perspectives

The challenge of creating cities and landscapes resilient to social and environmental change lies at the core of critical research in the design disciplines. These challenges are the consequences, direct and indirect, of a warming planet with nearly 8 billion diverse inhabitants, an increasing number of whom reside in coastal (mega)cities amid conditions of growing inequity, vulnerability and disparities in public health. Around the globe and at a range of scales, the professions and disciplines involved in the design and development of environmental and urban systems, are harnessing technologies and practices, both well-established and at the cutting edge, to play a significant role in formulating responses to such ecosystem stressors. Through its focus on urban resilience, the 2022 ARCC-EAAE International Conference addresses the multiplicity of ways in which new design pedagogies, research, and innovation, carried out across our disciplines and professions, empower us to educate a new generation of built environment designers, and to meet the strategic imperatives of this historical moment.

CLIMATE

Topic Co-Chairs: Jason Chandler and Roberto Rovira

Global Sustainability: Mitigation and Adaptation

Identified as the key challenge of our times, global sustainability is the core of the 17 United Nations Sustainable Development Goals (SDG). Focusing on the design disciplines and professions, this thematic area invites paper/poster contributions that propose new pedagogies, research and innovation in energy efficient design and construction, sustainable design processes that reduce the carbon footprint of the built environment, educational research on pedagogies for sustainable and resilient architecture, vernacular architecture, green design, adaptive, remedial and retrofit design strategies, as well as processes for evaluating resilience and sustainability.

Coastal Cities: Design Frameworks for Interconnectivity

By the year 2050, over 66% of the world's population will reside in cities. Today, nearly 40% of global urbanization is coastal, with approximately 10% of urban areas worldwide lying fewer than 10 meters above sea level (UN.org). The vulnerabilities associated with these conditions invite paper/poster contributions that propose new pedagogies, research, and innovation in adaptive design for coastal hazards and sea level rise, sustainable urban patterns and smart growth, infrastructure planning and design strategies, designing for extreme events in the coastal tropics, and dynamic planning, zoning and building regulations that incorporate a narrative of change over time.

TECHNOLOGY

Topic Co-Chairs: Biayna Bogosian and Eric Peterson

Materials and Advanced Digital Fabrication

The demand for increased building production and sustainable practices is driving technological integration into architectural curriculum and design practices. To keep up with this demand innovation in materials and methods as well as digital fabrication techniques have become ubiquitous in design and practice. Advances in performative materials, additive/subtractive manufacturing, and construction robotics have expanded our capabilities and created new fields of study. This thematic area encourages paper/poster contributions that propose new pedagogies, research and innovation in material design and robotics processes for design and construction/ fabrication.

Digital Design and Practices

Computational design practices have become a vital part of architectural production. However, emerging technologies Artificial Intelligence (AI), data acquisition via sensors, and Extended Reality (XR) are changing the landscape of research, innovation, design, and production. Integration of these advances with architectural practice is becoming increasingly critical for developing innovative and better performing built environments. Papers/posters in this theme address pedagogies and research in advanced digital processes for planning and design, including but not limited to advanced computational design, Internet of Things (IoT), environmental data collection and processing, Artificial Intelligence (AI) and new definitions of "craftsmanship" through digital practices.

EQUITY

Topic Co-Chairs: Gray Read and Elisa Silva

Inclusive Urban Landscapes

Landscapes of resilience and inclusion are the product of myriad elements, incorporating solutions to urban challenges that are both natural and created by human hands. Among them are the social and cultural integration of diverse populations, and responses to the barriers created by limited access to the critical elements of a safe, healthy, dignified life. This thematic area invites paper/poster contributions that propose new pedagogies and research that advance equity in the built environment; strategies that incorporate community engagement; and efforts that support the creation of affordable, accessible, equitable housing and public space for diverse communities.

Cities and (Im)migration

In its first two decades, the twenty-first century has produced substantial and growing number of global migrations, often provoked by environmental, socio-cultural, economic and political upheavals. These resettlements have stressed already-burdened environmental and urban systems, exacerbating a broad range of inequities. They foreground opportunities for the design disciplines to address and mitigate their impact, bringing new life to areas of tension and disinvestment; engaging strategies of integrative urban planning, and holistic, inclusive problem-solving. This thematic area encourages paper/poster contributions in new pedagogies, design innovation and research that address the urban challenges, at and beyond national borders, of global (im)migration(s) to urban centers.

PUBLIC HEALTH

Topic Co-Chairs: Newton D'souza and Magda Mostafa

Public Health and Public Space

Foregrounded by the COVID pandemic, the urban penalties associated with infectious diseases have often placed public health experts at the center of urban planning practice. To reduce disease transmission, zoning regulations were historically introduced to ease crowding and increase sanitation in cities. Such regulations have had implications for equity of access to public space. In turn, accessibility to open space has consequences for emotional and mental health, chronic disease, toxicity and violence. This thematic area encourages paper/poster contributions that address new pedagogies, research and innovation in urban and environmental design, including data-driven, trans-disciplinary and community engaged research that addresses inclusivity and public well-being.

Public Health and Human-Centered Design

Defined as innovative problem solving with the user(s) at its core, human centered design thinking can be effective, impactful, and scalable, by providing solutions to problems that range from discrete to systemic in scope. Collaborative, transdisciplinary approaches to questions of public health can result in solutions that address social and environmental vulnerability with unique effectiveness. This thematic area encourages paper/poster contributions that assess transformative, multi-disciplinary models of collaboration around public health; that actively engage communities; that incorporate human-centered, data-driven design thinking and that propose new pedagogical models for addressing these topics in the expanded studio and classroom.

SPECIAL TOPIC SESSION

Topic Chair: Neil Leach

Doctoral Education: Artistic Research, Design Doctorates and the Built Environment

This session aims to unveil new positions dealing with the issues of uncertainty, potentiality and creativeness in terms of responsible experimental gesturing, with reference to the Erasmus+ Strategic Partnership CA2RE+ (Collective Evaluation of Design Driven Doctoral Training) – an initiative exploring and developing immersive experiential research evaluation environments, where it explicates the integrative nature of architectural design research, able to face the contemporary knowledge fragmentation from humanities, social sciences and technology. The initiative and hence this session focuses on the interdisciplinary relevance of convergent thinking, mastering wicked problems, open-ended processes, resilience and risk, as well as orientation to future, all featured in Design Driven Research. Another aim is to unfold the didactic relevance of Design Driven Research for training creative professionals on how to use the integrative power of design thinking to master open-ended processes while solving contemporary spatial challenges through responsible experimental gesturing. We welcome project proposals especially design doctorates, aiming to enhance the built environment by means of artistic and design research.

KEYNOTE SPEAKERS AT ARCC-EAAE 2022 International Conference

PHILIPPE BLOCK

Professor, ETH Zurich and Block Research Group



“DISRUPTING CONCRETE CONSTRUCTION”

Philippe Block is Professor at the Institute of Technology in Architecture at ETH Zurich, where he co-directs the Block Research Group (BRG) together with Dr. Tom Van Mele. He is director of the Swiss National Centre of Competence in Research (NCCR) in Digital Fabrication, and founding partner of Ochsendorf DeJong & Block (ODB Engineering). Block studied architecture and structural engineering at the VUB, Belgium, and at MIT, USA, where he earned his PhD in 2009. Research at the BRG focuses on computational form finding, optimisation and construction of curved surface structures, specialising in unreinforced masonry vaults and concrete shells. Within the NCCR, BRG researchers develop innovative structurally informed bespoke prefabrication strategies and novel construction paradigms employing digital fabrication. With the BRG and ODB Engineering, Block applies his research into practice on the structural assessment of historic monuments in unreinforced masonry and the design and engineering of novel shell structures.

SUSANNAH DRAKE

DLANDstudio, New York



“COASTAL URBANISM”

Susannah Drake is a principal and founder of DLANDstudio, a leading multidisciplinary design firm. With qualifications in both architecture and landscape architecture, Susannah specializes in complex projects that require a synthesized, analytical, and research-based approach. All of her designs engage diverse systems to create ecologically and socially progressive projects that are equally well-crafted and beautiful. Susannah is a leader in resilient urban design and has dedicated much of her practice to developing and implementing design strategies to confront the impacts of climate change. The Gowanus Canal Sponge Park is a working landscape that improves the environment of the EPA Superfund site over time and Rising Currents, a collaboration with ARO Architects in MoMA's 2010 “A New Urban Ground” exhibition, set a design precedent in urban waterfront resiliency. Susannah's research has been at the forefront of innovation on urban ecological infrastructure. She is the recipient of the inaugural 2020 Climate Action Design Award by the Cooper Hewitt Smithsonian. Her exploration of campus landscape design and large-scale urban infrastructure has received funding through grants from the Graham Foundation, the Environmental Protection Agency, the New England Interstate Water Pollution Control Commission, the New York State Department of Environmental Conservation, and the New York State Council on the Arts.

TONI GRIFFIN

Harvard University and Founder, urbanAC



“JUSTICE AS SPACE AND PLACE: TOWARDS A NEW DESIGN VOCABULARY AND PRACTICE”

Toni L. Griffin is Professor in Practice of Urban Planning at Harvard University and founder of urbanAC, a planning and design management practice that works with public, private and nonprofit partnerships to reimagine, reshape and rebuild just cities and communities. urbanAC uses data-driven methods and a disruptive framework of policies and practices that produce outcomes designed to break down historic structures and systems of oppression, inequality and access. In Just City Lab, her team of research assistants have produced The Just City Index, Just City Indicators for the Public Realm, tools for civic engagement, design case studies and masterclasses and workshops on designing for justice. Her role as Project Director of the long-range planning initiative Detroit Work Project led to Detroit Future City, a comprehensive citywide framework plan for urban transformation. More recent clients include the cities of Memphis, Milwaukee and Pittsburgh. Ms. Griffin previously served as Professor of Architecture and founding Director of the J. Max Bond Center on Design for the Just City at the Spitzer School of Architecture at the City College of New York; Director of Community Development for the City of Newark; Vice President and Director of Design for the Anacostia Waterfront Corporation in Washington, DC, leading the planning for the Washington Nationals Ballpark District; and Deputy Director for Revitalization Planning and Neighborhood Planning in the D.C. Office of Planning.

JAMES MURLEY

Chief Resilience Officer, Miami-Dade County



“MIAMI-DADE COUNTY: THE ROAD TO RESILIENCE”

James F. Murley is the Chief Resilience Officer for Miami-Dade County. Miami-Dade County, together with the Cities of Miami and Miami Beach, launched their Resilient 305 Strategy in May 2019. Jim previously served as Secretary of the Department of Community Affairs under Governor Lawton Chiles and was appointed Chair of the Florida Energy and Climate Commission by Governor Charlie Crist. Additionally, he served as Executive Director of 1000 Friends of Florida, spent over 10 years with Florida Atlantic University overseeing research on urban and environmental issues, and served as Executive Director of the South Florida Regional Planning Council. Jim is a founding member of the American Society for Adaptation Professionals and Resiliency Florida, a Board member of The Florida Ocean Alliance and the Southeast Coastal Ocean Observing Regional Association. He serves as Mayor Levine Cava’s designee on the Miami River Commission. He is also a Fellow of the National Academy of Public Administration.

JEREMY TILL

Head of Central Saint Martins, Pro-Vice Chancellor, University of the Arts



“ARCHITECTURE AFTER ARCHITECTURE: SPATIAL PRACTICE IN THE FACE OF THE CLIMATE EMERGENCY”

*Architect Jeremy Till is Head of Central Saint Martins and Pro-Vice Chancellor of the University of the Arts. He previously served as Dean of Architecture and the Built Environment at the University of Westminster and Head of Architecture at the University of Sheffield. He is co-recipient of the RIBA Sustainability Prize for 9 Stock Orchard Street and co-author of *The Everyday and Architecture* (Academy Press, 1997), both with Sarah Wigglesworth. He is also author of numerous subsequent books, including *Flexible Housing* (Architectural Press, 2007), co-authored with Tatjana Schneider, *Architecture Depends* (MIT Press, 2009), and *Spatial Agency* (Routledge Press, 2011), co-authored with Nishat Awan and Tatjana Schneider. All three of these books won the RIBA President’s Award for Outstanding Research. More recently, he worked on a major EU-funded research project on scarcity and creativity, resulting in the book, *The Design of Scarcity* (Strelka Press, 2015), co-authored with Jon Goodbun, Michael Klein and Andreas Rumpfhuber. He curated the British Pavilion at the 2006 Venice Architecture Biennale, co-curated (with a team from CSM) the UK Pavilion at the 2013 Shenzhen Biennale and participated in the 2013 Lisbon Triennale. He also serves as a trustee of the New Economics Foundation, a leading think tank devoted to research and promoting new forms of economics.*

**LIST OF PAPERS + POSTERS OF
ARCC-EAAE 2022 INTERNATIONAL CONFERENCE**

TRACKS

**CLIMATE
TECHNOLOGY
EQUITY
PUBLIC HEALTH
DOCTORAL EDUCATION**

> CLIMATE

Housing, Live/Work and Thermal Comfort Prediction

- Existing Multifamily Building Stock Energy Use and Building Code Comparison Between the United States and Finland** p. 1-8
Ming Hu, University of Maryland
- Towards Alternative Live-Work Development: An Integrated Design Approach** p. 9-16
Christina Payenhofer, Southern Illinois University
Mehdi Ashayeri, Southern Illinois University
- Machine Learning-Based Automated Thermal Comfort Prediction: Integration of Low-Cost Thermal and Visual Cameras for Higher Accuracy** p. 17-24
Roshanak Ashrafi, University of North Carolina at Charlotte
Mona Azarbayjani, University of North Carolina at Charlotte
Hamed Tabkhi, University of North Carolina at Charlotte

Heat Islands, Land-Based Infrastructures and Epidemiology

- Urban Heat Island Phenomena in Dhaka, Bangladesh** p. 25-32
Tasneem Tariq, Pennsylvania State University
Ute Poerschke, Pennsylvania State University
Lisa Domenica Iulo, Pennsylvania State University
- Water, Fire, Land, Air: Investigating Land-based Infrastructures** p. 33-40
Jessica Rossi-Mastracci, University of Minnesota
- Architectural Epidemiology: A Multidisciplinary Method for Turning Small Scale Design Decisions into Large Scale Action on Climate & Chronic Disease** p. 41-48
Adele Houghton, Harvard University
Carlos Castillo-Salgado, Johns Hopkins School of Public Health

Resilient Post-Disaster Housing and Health Outcomes

- Advanced Modular Housing Design for Highly Efficient, Affordable, and Resilient Post-Disaster Housing** p. 49-56
Forough Foroutan Jahromi, University of Florida
Jeffrey Andrew Carney, University of Florida
- A Proposed Evaluation Tool for the Resiliency of Post-disaster Housing: A Case Study of a Post-Earthquake and Tsunami Social Housing Development in the Coast of Southern Chile** p. 57-62
Daniela Scheuermann, Universidad de Concepción
Andrea Soledad Martinez Arias, Universidad de Concepción
María Isabel Rivera, Researcher, Centre for Sustainable Urban Development (CEDEUS)
- Access To Green Space in Neighborhoods Influence Health Outcomes for Different Racial and Income Groups: A Case Study of California** p. 63-72
Jiaying Dong, Clemson University
Dina Battisto, Clemson University

> **CLIMATE** (continued)

Schools, Hybrid Infrastructures and Social Scorecards

Observations of Thermal Comfort Conditions in Two Schools in Southern California and Nairobi, Kenya p. 73-80

David Mwale Ogoli, California Baptist University

Nature-Based and Hybrid Infrastructures to Build Resilient Cities through the Rivers: Two Case Studies in Addis Ababa (Ethiopia) p. 81-88

Ruben Garcia-Rubio, Tulane University

Ryan Green, Tulane University

Sonsoles Vela, Tulane University

Social Scorecard: A Comprehensive Social Health Analysis Tool p. 89-98

Edgar Stach, Institute for Smart and Healthy Cities, Thomas Jefferson University

Summer Koch, Institute for Smart and Healthy Cities, Thomas Jefferson University

Waterfront Resilience, Carbon Positive Scenarios and Third Spaces

Resilience at the Water's Edge p. 99-104

Vera Parlac, New Jersey Institute of Technology

Climate Resilient Urban Nexus Choices for Carbon Positive and SynBio City Scenarios from 2018 to 2100 p. 105-112

Thomas Spiegelhalter, Florida International University

Spatial Appropriation During the Pandemic: Analysis of Two Parallel Cases p. 113-120

Carey Clouse, University of Massachusetts Amherst

Caryn Brause, University of Massachusetts Amherst

Green Space, Walkability and Agility in the Built Environment

Whose Heritage, Whose Investment, Whose Sustainability? Multi-actor Dynamics Around Green Space in Late-Modernist Residential Developments (Bordeaux, France) p. 121-128

J. Kent Fitzsimons, Laboratoire PAVE, École Nationale Supérieure d'Architecture et de Paysage de Bordeaux

Fanny Gerbeaud, Laboratoire PAVE, École Nationale Supérieure d'Architecture et de Paysage de Bordeaux

Walking Towards a Sustainable Future for Urban Design p. 129-136

Summer Stevens, University of Florida

Nawari Nawari, University of Florida

Michael Volk, University of Florida

Co-Design Strategies to Achieve Trust in Urban Living Lab: A Systematic Literature Review p. 137-144

Carla Brisotto, Florida Institute for Built Environment Resilience

Jeffrey Andrew Carney, Florida Institute for Built Environment Resilience

> **CLIMATE** (continued)

Modeling Methods of Facades and Rooftops

- Building a Workflow to Model a Green Façade in a Graphical User Interface for EnergyPlus** p. 145-152

Sydney Collin, Center for Building Energy Research, Iowa State University
Ulrike Passe, Department of Architecture, Iowa State University

- An Interactive GIS-based Method to Map Feasible Roof Areas for PV Panels** p. 153-160

Sedigheh Ghiasi, Iowa State University
Ulrike Passe, Iowa State University
Yuyu Zhou, Iowa State University

- Rooftop Additions: An Alternative Model of Urban Growth** p. 161-166

Oliver Chamel, Florida A&M University
Bernd Dahlgreen, Hafen City Universität Hamburg
Laurent Lescop, Ecole Nationale Supérieure d'Architecture Nantes

Cartography, Climate and Cross-Cultural Considerations

- Metropolitan Cartography: An Inventive Practice Tool for Caring Metropolitan Landscapes** p. 167-174

Antonella Contin, Politecnico di Milano
Valentina Galiulo, Politecnico di Milano and Universidad de Sevilla
Domingo Sánchez Fuentes, Universidad de Sevilla

- Nature Based Solutions and Circular Economy: Structuring a Long-Term Project for a Climate Resilient Design** p. 175-182

Kevin Santus, Politecnico di Milano

- Critical Explorations of Architecture Education in a Rapidly Changing World: Cross-Cultural Considerations of the Double-Edged Sword of Professional Competency and Global Citizenship** p. 183-190

Brian R. Sinclair, University of Calgary
Raffaello Furlan, Qatar University

Cities and Resilience: Strategies and Evaluation

- Water Resilience: Mapping and Active Borders as Instruments for Climate-Resilient Waterfront Design Strategies** p. 191-200

Elena Verzella, University of Ferrara

- Understanding Efficient Mitigation Strategies for Los Angeles' Heat Islands Using OLS Regression Analysis** p. 201-208

Olivia Vander Poel Lewis, Callison RTKL
Pablo La Roche, Callison RTKL
Joey-Michelle Hutchison, Callison RTKL
Arianne Ponce, Callison RTKL

- Evaluating the Circadian-Effectiveness of Light through Personal Light Exposure Measurement: An Initial Test Using a Low-Cost and Wearable Spectrometer in Home-Office** p. 209-216

Armin Amirazar, University of North Carolina at Charlotte
Mona Azarbayjani, University of North Carolina at Charlotte
Maziyar Molavi, University of North Carolina at Charlotte

> **CLIMATE** (continued)

Urban Mapping: Frameworks and Tools

Mapping Blindspots in Urban Atmospheric Pollution Assessment in the US-Mexico Borderland p. 217-224

Stephen Mueller, Texas Tech University

Connect or Adapt: Analytic Framework for the Planning and Design of Resilient Spatial Networks p. 225-234

Daniel Kin Heng Wong, Singapore University of Technology and Design

Wei Chien Benny Chin, Singapore University of Technology and Design

Roland Bouffanais, University of Ottawa

Thomas Schroepfer, Singapore University of Technology and Design

MODE_Bios: A Bioclimatic, Adaptive, Urban Design Tool p. 235-240

Polyxeni Mantzou, Democritus University of Thrace

Anastasios Floros, Democritus University of Thrace

Emergent Processes, Complexity and Global Warming

Rebellion, Robotics, and a Radical Reboot: Emergent Processes in Turbulent Times p. 241-248

Dustin Couzens, Modern Office of Design + Architecture

Brian R. Sinclair, University of Calgary and sinclairstudio, inc.

Ben Klumper, Modern Office of Design + Architecture

Uncertainty, Complexity + Change: A Cohesive Frame to Advance Agility in the Built Environment p. 249-256

Salah Imam, University of Calgary and Entuitive Corporation

Brian R. Sinclair, University of Calgary and sinclairstudio, inc.

From Cold War to Global Warming: Dilemma's in Retrofitting the Modernist University Campus in Latin America. Case study: Quito, Ecuador p. 257-264

Victor Hugo Molina, Technical University of Ambato

Circular Economy and Life Cycle Considerations

Mapping of Research Lines on Circular Economy Practices in Cities: From Waste to Infrastructure p. 265-272

Patricia Njideka Kio, Texas A&M University

Ahmed Kamal Ali, Texas A&M University

Beyond Operational Energy Efficiency: A Balanced Sustainability Index from a Life Cycle Consideration p. 273-280

Ming Hu, University of Maryland

> TECHNOLOGY

Infrastructure, Smart City and Crossbred Urbanism

Strategies for Redesigning High Performance FRP Wind Blades as Future Electrical Infrastructure p. 281-288

Tristan Farris Al-Haddad, Georgia Institute of Technology
Ammar Alshannaq, Georgia Institute of Technology
Lawrence Bank, Georgia Institute of Technology
Mehmet Bermek, Georgia Institute of Technology
Russell Gentry, Georgia Institute of Technology
Yulizza Henao-Barragan, Georgia Institute of Technology
Sean Li, Georgia Institute of Technology
Alex Poff, Georgia Institute of Technology
John Respert, Georgia Institute of Technology
Colin Woodham, Georgia Institute of Technology

The Public and the Technocratic Smart City p. 289-296
Taraneh Meshkani, Kent State University

Precedent and Influence: An Urban Design Studio Project p. 297-302
Dwayne Carver, University of Idaho

Surface, Structure and Light: CNC Technologies and Karamba3d

Building Surface Thermal Modulation: Applying Biomimicry and CNC Technologies for Creating Textured Building Façades p. 303-310
Eiman Mohammad Graiz, University of Kansas
Keith Van De Riet, University of Kansas

Enabling Structural Resolution in Architectural Design Studio Using Karamba3D p. 311-318
Chengde Wu, Iowa State University
David Thaddeus, University of North Carolina at Charlotte
Danielle Scaccia, University of North Carolina at Charlotte

Design Principles for Museum Daylight Systems Based on Nine Built Examples from Renzo Piano Building Workshop p. 319-326
Edgar Stach, Thomas Jefferson University
Michael Esposito, Elementa Engineering

Preservation, Performance and Prototype

Configurable Resiliency: Generating Sustainable Designs in Historic Neighborhoods p. 327-334
Mahyar Hadighi, Texas Tech University

Evaluation of the Bioclimatic Building Performance in Hot Climate p. 335-344
Abdou Idris, Université de Djibouti, Faculté d'Ingénieurs, CEALT/LME
Abdoulkader Ibrahim, Université de Djibouti, Faculté d'Ingénieurs, CEALT/LME
Assabo Mohamed, Université de Djibouti, Faculté d'Ingénieurs, CEALT/LME

Informing Early-Stage Building Energy Retrofit for Prototypical Public Schools in Chile p. 345-352
Andrea Soledad Martinez, Universidad de Concepción
María Isabel Rivera, Universidad de Concepción
Pablo Arriagada, Researcher, Centre for Sustainable Urban Development (CEDEUS)

> **TECHNOLOGY** (continued)

VOC Reduction, Insulation Refreshed and Wallboard Modularity

An Air-Depolluting System for Indoor VOC Reduction p. 353-358

Ketki Bapat, University of North Carolina at Charlotte
Ok-Kyun Im, University of North Carolina at Charlotte
Chengde Wu, Iowa State University
Kyoung-Hee Kim, University of North Carolina at Charlotte

Modular Makeup: Reconsidering Modularity of Gypsum Wallboard p. 359-366

Alyssa Kuhns, University of Arkansas
Jeff Kim, Auburn University

Matter, Topology and Fabrication

Topology + Timber p. 367-374

Tsz Yan Ng, University of Michigan
Wes McGee, University of Michigan

Fabric Formed Poured Earth: Using Urban Site Soils in Fabric to Eliminate Portland Cement p. 375-382

Charlie O'Geen, Kendall College of Art and Design
Catherine Page Harris, University of New Mexico

Employing Topology Optimization for Establishing Design Variability in Precast Façade Panels p. 383-390

Niloufar Emami, University of Illinois at Urbana-Champaign

Spatial Performance, Analysis and Modeling

Evaluation of Spatial Performance in Vertically Integrated Developments Using a Network Science-Based Approach p. 391-398

Srilalitha Gopalakrishnan, Singapore University of Technology and Design
Chirag Hablani, Singapore University of Technology and Design
Daniel Wong, Singapore University of Technology and Design
Benny Chin, Singapore University of Technology and Design
Anjanaa Srikanth, Singapore University of Technology and Design
Ajaykumar Manivannan, University of Ottawa
Roland Bouffanais, University of Ottawa
Thomas Schroepfer, Singapore University of Technology and Design

Visual Data-Based Spatial Analysis of Built Environments p. 399-406

Chirag Hablani, Singapore University of Technology and Design
Daniel Wong, Singapore University of Technology and Design
Thomas Schroepfer, Singapore University of Technology and Design

Thermoelectric Facades: Modeling Procedure and Comparative Analysis of Energy Performance in Various Climate Conditions p. 407-414

Ajla Aksamija, University of Utah
Mahsa Faidr Mohajer, University of Massachusetts Amherst

> **TECHNOLOGY** (continued)

Pedagogical Tools and Designing for Change

- Building with Air: The Internet of Things (IoT) as a Pedagogical Tool for Design-Build Education** p. 415-422
Nate Shigeo Imai, Texas Tech University
- Exploring Low-cost Acoustic Panels with Origami Patterns for Classrooms** p. 423-430
Julio C. Diarte, Pennsylvania State University, Universidad Nacional de Asuncion
Elena M. Vazquez, Pennsylvania State University
- Design for Change: Climate Centered Pedagogy in the Architecture Studio** p. 431-438
Gabriel Kaprielian, Temple University

> EQUITY

Reimagined Growth and Informal Urbanisms

Reimagining Growth: Cross Analysis of Environmental and Social Data Between Shifting Populations p. 439-446

Nicole Hall, School of the Art Institute of Chicago
Milad Hosseini-Mozari, University of Utah

The Unreachable Rivers and the Informalities of Medellín and Beirut p. 447-454
Taraneh Meshkani, Kent State University

Viral Resiliency: Reconstructing Extra-Legal Settlements Through Dialogical Practices p. 455-464
Scott Gerald Shall, Lawrence Technological University

Mapping, Memory, and Space of the Body

Indeterminate Space p. 465-472
Peter Wong, University of North Carolina at Charlotte

Drawing Memories: Mapping as Part of Oral History p. 473-478
Gray Read, Florida International University

Spatializing the Body: Feminist Practice as Architectural Research p. 479-486
Elizabeth Marie Cronin, University of Florida

Pedagogy, Equity and Social Justice

Inclusive Pedagogies in Theory Sequence Courses p. 487-492
Larisa Sherbakova, *Florida Agriculture and Mechanical University*
Shalya Thomas, *Florida Agriculture and Mechanical University*
Amanda Grace, *Florida Agriculture and Mechanical University*
Basma Binmahfooz, *Florida Agriculture and Mechanical University*

Discrimination and Design: Equity, Justice, and Architectural Education p. 493-500
J. Philip Gruen, *Washington State University*

Critical Pedagogy and Public Interest Design: Transforming Architecture Design Education for Social Justice p. 501-508
Erika Zekos, *University of Massachusetts Amherst*

> **EQUITY** (continued)

Resilient Housing, Affordability and Housing Insecurity

Geohome: Affordable, Resilient Housing Prototype p. 509-514
George Elvin, North Carolina State University

**Approaches to Affordable Housing Design Using VAE and Space Syntax:
Case Studies from Los Angeles** p. 515-522
Junyoung Myung, University of Illinois at Urbana-Champaign
Jung Yun Choi, Seoul National University
Taegyu Lee, Seoul National University

**Housing Insecurity and Latinx Community Resilience in Small Towns in
Mississippi** p. 523-530
Silvinia Lopez Barrera, Mississippi State University
Diego Thompson, Mississippi State University

Resilience, Social Equity and Access

Neighborhood Design with Community Engagement p. 531-538
Julia Robinson, University of Minnesota (Architecture)
Brandon Champeau, United Properties
Jamil Ford, Mobilize Design & Architecture
Timothy Griffin, University of Minnesota (Minnesota Design Center)
Cathy Spann, Jordan Area Community Council

**Designing for Wellbeing: The Role of Architecture in Addressing
Social Equity in Response to COVID-19** p. 539-546
Ebtehal Bahnasy, University of Minnesota

Trends and Correlates of Neighborhood Park Access in Philadelphia p. 547-554
Tiara Halstead, Thomas Jefferson University
Russell McIntire, Thomas Jefferson University

Immigrant Landscapes, Shifting Identities and Health Equity

**Intercultural Suburbs: The Urban Design Alternatives of International Immigrants
in Toronto's Modern Landscapes** p. 555-562
Giacomo Valzania, McGill University

**Creating the "Foreign" Place through "Windows": Shifting Urban Forms in
Seattle's Chinatown** p. 563-570
Xiao Hu, University of Idaho

**Exploring Health Equity and the Built Environment through the Social
Determinants of Health** p. 571-578
Traci Rose Rider, North Carolina State University
Victoria A. Lanteigne, North Carolina State University
Aaron Hipp, North Carolina State University
Rosa McDonald, Baker Ingenuity Group
Kia Baker, North Carolina State University

> PUBLIC HEALTH

Youth, Walkability, and Climate Resilience

Creating a Building for the Purpose of Helping Youths: An Instrumental Qualitative Case Study p. 579-586

Nima Meghdari, University of Minnesota

Evaluation of Net Zero Energy Buildings for Climate Resilience in Southeast U.S. p. 587-594

Manan Singh, University of Florida
Ryan Sharston, University of Florida

Natural Ventilation, External Shading and Human Health

The Impact of Efficient Natural Ventilation on the Indoor Environmental Air Quality: The Case of a Social Housing in Turkey p. 595-598

Ezgi Bay, University of Utah
Antonio Martinez-Molina, University of Texas at San Antonio

Efficacy of External Shading Devices and Natural Ventilation during Extreme Heat for a Seattle Multi-family Apartment Unit p. 599-608

Teresa Fotini Moroseos, Integrated Design Lab, University of Washington
Heather Burpee, Integrated Design Lab, University of Washington
Christopher Meek, Integrated Design Lab, University of Washington

Modernity and Human Health: The Connection to Outdoor Air p. 609-616

Elizabeth L. McCormick, University of North Carolina at Charlotte
Traci Rider, North Carolina State University

Walkability: Anchors, Assessment and Engagement

Built Environment and Walking Behavior: A Systematic Review on Campus Walkability Assessments p. 617-624

Gisou Salkhi Khasraghi, Texas Tech University

Walking as Engagement p. 625-630

Sarah Gamble, University of Florida

Biophilic Performance, Healthcare and Health Resorts

Resilient Sites: Mapping K-12 Schools' Context Biophilic and Energy Performance p. 631-640

Ihab Elzeyadi, University of Oregon

'Configurational' Accessibility of Healthcare Facilities in Dammam, Saudi Arabia: A Space Syntax Study p. 641-650

Ahmed Abdulaziz Alrashed, Imam Abdulrahman Bin Faisal University
Saif Haq, Texas Tech University

Miami Solarium (1928) to the Sun Ray Health Resort: From a Hotel-Sanatorium to Hotel-Health-Resort-Spa p. 651-658

Vandana Baweja, University of Florida
Sonny Russano, University of Florida

> **PUBLIC HEALTH** (continued)

Community Knowledge, Equitable Design and Birth Spaces

Data Dissonance: An Exploration of Community Knowledge of Extreme Temperature Vulnerabilities p. 659-666

Nina Spellman, Northeastern University
Michelle Laboy, Northeastern University

Impact of Climate Change in Houston TX: Resilient Residential Buildings and Equitable Design p. 667-674

Raffaella Montelli, University of Houston
Mili Kyropoulou, University of Houston

The Multi-level impacts of the Physical Environment on Childbirth Experience: A Critical Literature Review p. 675-682

Rafah Altaweli, University of Cincinnati
Pravin Bhiwapurkar, University of Cincinnati

Health, Lighting and Human Perception

Exploring the Impacts of Human-Centric Lighting Spatial Patterns on Elderly Residents Mood and Preference – An Architectural Content Analysis p. 683-690

Nasrin Golshany, University of Oregon
Ihab Elzeyadi, University of Oregon

Exploring the Role of Human Perception: A Comparative Analysis of Human Thermal Comfort and Urban Design Parameters p. 691-698

Naveed Mazhar, Northern Alberta Institute of Technology
Enrica Dall'Ara, University of Calgary
Brian R. Sinclair, University of Calgary

Exploring the Walkability in a Hospital-Anchored Neighborhood: A Case Study of Emory University Hospital Midtown Campus p. 699-706

Xiaowei Li, Clemson University
Dina Battisto, Clemson University

Role of Housing in Community Resilience

Through the Eyes of The Public: The Promotion of Social Rental Housing (SRH) as a Focal Point in Addressing Housing Resilience p. 707-716

Chika Chioma Daniels-Akunekwe, University of Calgary
Brian R. Sinclair, University of Calgary and sinclairstudio, inc.

The Public Restroom as a Site of Cultural Conflict p. 717-724

Edward Steinfeld, University at Buffalo, State University of New York
Adam Thibodeaux, University at Buffalo, State University of New York
Shira Gabriel Klaiman, University at Buffalo, State University of New York

Adaptive Streets: Increasing Social and Ecological Resilience Along a Cross-city Bicycle Boulevard p. 725-732

Courtney Crosson, University of Arizona

> PUBLIC HEALTH (continued)

Comfort and Health, Resilience and Assessment

Integrating Biophilic, Net-Positive, and Resilient Design: A Framework for Architectural Education p. 733-740

Mary Margaret Guzowski, University of Minnesota

The Neighborhood Accessibility Framework: A Methodological Instrument to Assess Neighborhood-Level Determinants That Affect the Health of Urban Residents p. 741-748

Hitakshi Sehgal, University of Minnesota

Dwellings in the COVID-2019 Pandemic Times: Perspective of Six Female Architecture Students from the Midwest USA p. 749-756

Mania Tahsina Taher, University of Wisconsin-Milwaukee

> DOCTORAL EDUCATION

Doctoral Residency, Education and Design Dissertation

Minimal Residency Doctoral Education p. 757-762

Neil Leach, Florida International University

A New DDes Program in Architecture at Florida International University Focusing on Technology and Sustainability p. 763-768

Gray Read, Florida International University

Biayna Bogosian, Florida International University

Shahin Vassigh, Florida International University

A Systematic Literature Review of Ph.D. in Design Dissertations: A Case Study at North Carolina State University p. 769-776

Jinoh Park, North Carolina State University

Yeobeom Yoon, North Carolina State University

Byungsoo Kim, North Carolina State University

> RESEARCH POSTER ABSTRACTS

- The ACP Project: Focus Groups, Interviews + Ethnographic Research** p. 777
Andrew Chin
Florida A&M University
- Sensitivity Analysis and Multi-Objective Optimization of Skylight Design in the Early Design Stage** p. 777
Yuan Fang, Western Kentucky University
Le Fan, China Academy of Building Research Institute
- Florida Domestic Architecture in the 1940's: Economy House** p. 778
Vandana Baweja and Sarah Gurevitch
University of Florida
- Modeling Healthfulness** p. 778
Ulysses Sean Vance
Temple University
- Accessory Carbon Units** p. 779
Robert Williams
University of Massachusetts Amherst
- The Alternating Dock** p. 779
Ana Tricarico Orosco
Louisiana State University
- Bio-Cities: Synthetic Biology and Architecture in Coastal Communities** p. 780
Alfredo Andia
Florida International University
- Deployable Pod: A Case Study of Applied Transformable Design Research** p. 780
Rachel Dickey and Noushin Radnia
University of North Carolina at Charlotte
- Revisiting Modernist Mass-Housing: Residents as Active Agents of Change** p. 781
Nadia Shah
Illinois Institute of Technology
- Towards a Zero Waste University Campus** p. 781
Júlia Pokol
Budapest University of Technology and Economics
- Personalizing Climate Change: Measuring and Adapting Sea Level Rise Perceptions** p. 782
Leonard Yui
Roger Williams University
- The Side-Yard House Model: Creating Green and Resilient Communities** p. 782
Craig S. Griffen
Thomas Jefferson University
- Bio-Materials: Explorations Around Bacterial Cellulose** p. 783
Mercedes Garcia Holguera
University of Manitoba

> RESEARCH POSTER ABSTRACTS (continued)

- Rights, Sagacity + The Devil's Crop: Provocations in an Ethos of Design, Dissolution + Disarray** p. 783
Brian R. Sinclair
University of Calgary
- Striving for a Common Goal: Coastal Resilience through Interdisciplinary Design** p. 784
Jori Ann Erdman, *James Madison University*
Tiffany Troxler, *Florida International University*
- The Scalability of Urban Agriculture: Chicago Case Studies** p. 784
Kristin Jones
Illinois Institute of Technology
- Tensegrity Knit Helix Tower Light Weight Deployable Structure** p. 785
Virginia Melnyk
University of Michigan, Tongji University
- Experiencing the Vortex** p. 785
Pari Riahi, Fey Thurber, Erica DeWitt, Cami Quinteros, Pieter Boersma,
Adrian Carleton, Ali Sarvghad, Yahya Modarres-Sadeghi
University of Massachusetts Amherst
- Assessing Architectural Design Factors of Maternity Ward that Influence Quality of Health Care and Patient Outcomes at Queen Elizabeth Central Hospital in Blantyre, Malawi** p. 786
Chris Harnish, Luis Gadama, Zayithwa Fabiano, Meghan Gannon, Kayla Holston,
Stephanie Catrambone
Thomas Jefferson University
- The Renewal Design of Dong Timber Dwelling Based on Tas Software: The Case Study of Gaobu** p. 786
Xiaoyun Liu
Politecnico di Milano
- Design for Youth: Research in the Design Studio School of Architecture** p. 787
Julia W. Robinson
University of Minnesota
- The Future of Food Production: Urban Farming Towards Food Self-Sufficiency** p. 787
Camilo Cerro
American University of Sharjah
- The Strange Sources of Brazil's Modern Architecture: The Neocolonial Style in the Centennial Exposition (1922)** p. 788
Camila Miranda Feltrin and Maria Teresa Dias da Fonseca
Faculdade de Arquitectura da Universidade do Porto
- Urban Design Mitigations: Considering COVID-19's Impact on Public Space** p. 788
Deirdre Hennebury, Fernando Cirino
University of Michigan
- Considering Health + Wellness Beyond Convention: Spirituality, Space and the Critical Case of Sufism** p. 789
Nooshin Esmaeili, Brian R. Sinclair
University of Calgary

> RESEARCH POSTER ABSTRACTS (continued)

- VR Gestural Modeling to Recapture the Human Body in Design** p. 789
Sara Codarin, Karl Daubmann
Lawrence Technological University
- Building in the Digital Transformation: Translations from Design to Technological-enabled Demountable Building** p. 790
Sara Codarin, Karl Daubmann, Emily Kutil, Kristen Dean
Lawrence Technological University
- Carbon-Positive, and Synthetic Biological Architecture Imaginations for Miami Greater Islands 2021-2100** p. 790
Thomas Spiegelhalter
Florida International University
- Indigeneity, Imagination, Equity + Design: Ethical Space and Complementary Ways of Knowing** p. 791
Brian R. Sinclair
University of Calgary
- Complexity Science-based Analysis of Sustainable Integrated Urban Districts** p. 791
Anjanaa Devi Srikanth, Chirag Hablani, Benny Chin, Thomas Schroeppfer
Singapore University of Technology and Design
- Amphibian Typologies and The Urban Imaginary** p. 792
Mona El Khafif, Darcy Engle
University of Virginia
- RIVERGAN: Fluvial Landforms Generation Based on Physical Simulations and Generative Adversarial Network** p. 792
Xun Liu, University of Virginia
Runjia Tian, Harvard University
- Re-Commissioning Land: Spatial and Temporal Urban Strategies for Coastal Territories** p. 793
Mona El Khafif, Ali Fard
University of Virginia
- Postcards from the Future: Climate Fiction as Architecture Pedagogy** p. 793
Gabriel Kaprielian
Temple University
- Equitable Access to Building Construction Through Advancements in Open and Global Building Machine Technology** p. 794
Elizabeth Andrzejewski, Marcus Shaffer, Esther Obonyo
Pennsylvania State University
- Deploy 2.0** p. 794
Ana Morcillo Pallares and Jonathan Rule
University of Michigan
- The Role of Architecture in the Therapeutic Environment: The Case of the Maggie's Cancer Care Centre** p. 795
Caterina Frisone
Oxford Brookes University

Existing Multifamily Building Stock Energy Use and Building Code Comparison Between the United States and Finland

Ming Hu¹

¹University of Maryland, College Park, MD

ABSTRACT: Due to the high heating demand, energy savings in residential buildings in cold climates has played an important role in reducing carbon emissions. The study aims to investigate differences between the United States and Finland regarding characteristics and energy retrofit practices of current multifamily buildings (MFBs). This paper first presents an overview of the status of multifamily housing stocks in the two countries, followed by an explanation of energy use patterns of residential buildings in both countries. Then, building codes related to energy efficiency in Finland and the United States are examined as well as major differences among the codes. The preliminary results indicate three differences: (1) For the existing MFB stock, the United States has a higher average energy use, at 266 kWh/m² (cold and very cold regions), compared to that of Finland, at 235 kWh/m². (2) Finland has more stringent energy code requirements that contribute to lower energy use in similar cold climate conditions. The discussion and conclusion are drawn upon those findings.

KEYWORDS: carbon emission, multifamily buildings, United States, Finland

INTRODUCTION

Since 2002, EU member states have been following and implementing the EU's Energy Performance of Buildings Directive (Directive 2002/91) to achieve greater energy efficiency and reduced carbon emissions through nZEB for new buildings beginning in 2020. nZEB retrofits are required by 2050 for all member states, and each EU member state must establish its own long-term retrofit strategies to achieve the goal (European Union. (2018). In the European Union, nZEBs are defined as "buildings with very high energy-efficiency, and the remaining energy demand for those highly efficient buildings is largely met through renewable energy supply, including the energy generated on the building site or nearby" (European Union 2010). In the United States, there is no country-wide mandate for ZEBs or nZEBs, although some states are more advanced than others. For example, the state of California published the Energy Efficiency Standards for Residential and Nonresidential Buildings (Title 24) with the requirements that all new residential construction will be zero net energy by 2020, all new commercial construction will be zero net energy by 2030, 50% of commercial buildings will be retrofitted to ZEBs by 2030, and 50% of new major renovations of state buildings will be ZEBs by 2025 (Hu & Qiu 2019). In the United States, ZEBs are described as buildings that combine energy efficiency and renewable energy generation to consume only as much energy as can be produced onsite through renewable resources over a certain period (DOE).

1.0 BACKGROUND

Finland was selected for a comparison with the United States for two reasons. First, in Finland, the energy consumption per capita is the second highest among EU countries due to its cold climate and energy-intensive industries (Kangas et al., 2018). Second, Finland is regarded as one of the top three most progressive countries in terms of energy efficiency policies in the EU and has been leading efforts in energy use and carbon emission reductions (The European Portal for energy efficiency in buildings). In Finland, buildings use around 38% of total energy and contribute to 32% of the country's total CO₂ emissions (Statistics Finland 2016). At the end of 2020, there were 1,319,000 residential buildings—including attached houses, detached houses, and MFBs (apartments)—and 47% of them were MFBs (Statistics Finland). By the end of 2015, the United States had 118,200,000 residential buildings, and 12% of them were MFBs. By the end of 2020, residential buildings in the United States accounted for around 22% of total energy use (EIA). The total number of residential buildings in cold and very cold climates in the United States is around 6,600,000, which accounts for 36% of total multifamily housing (EIA). In the United States, cold and very cold climate regions are defined using heating degree days (HDD), average temperature, and precipitation data (Office of Energy Efficiency & Renewable Energy). This method was first defined in the Residential Energy Use Survey conducted in 2015, which is administered by the U.S. Energy Information Administration (EIA).

2.0 MATERIALS AND METHOD

Figure 1 illustrates the comparable cold (in blue) and very cold (in purple) regions in the U.S. that are of a similar climate to Finland. The cold region includes climate zone 6 (6A and 6B) in the U.S and the very cold region includes climate zone 7, based on International Energy Conservation Code (IECC) (Department of Energy). The climate zone outside of the map included in this study is zone 8, that is explained in Figure 8. Climate 6 represents Dfa climate type in Köppen climate classification, and 7 represents Dfb climate type. Prior to 2004, there was no single, agreed-upon climate zone map for the U.S for use with building energy codes. In the early 2000s, the U.S Department of Energy developed a U.S climate zones map based on widely accepted classification of the world climate (Köppen climate classification) and data analysis from weather stations of over 4,700 sites. Since then, 2004 IECC adopted this climate map as the first model energy code, and this map was also adopted by ASHRAE 90.1 in its 2004 edition. Both the U.S. and Finnish design requirement and building code is based on HDD, a measurement used to quantify the demand for energy needed to heat buildings. The HDD is calculated by adding up the differences of the desired indoor and outdoor average temperatures, typically over a one-year period, for the purpose of building energy planning. Mathematically it is represented in Equation 1 (Day 2006).

$$HDD = \sum_{i=1}^{365} (T_{base} - T_i) \quad \text{Equation 1}$$

Where T_i is the daily outdoor temperature, T_{base} is the base temperature, in U.S, it is 18.3°C (65°F) and 17°C in Finland (62.6°F). In Finland, HDD excludes days when the average temperature is above 10°C (50°F) in the spring and above 12°C (53.6°F) in autumn (Finnish Meteorological Institute).

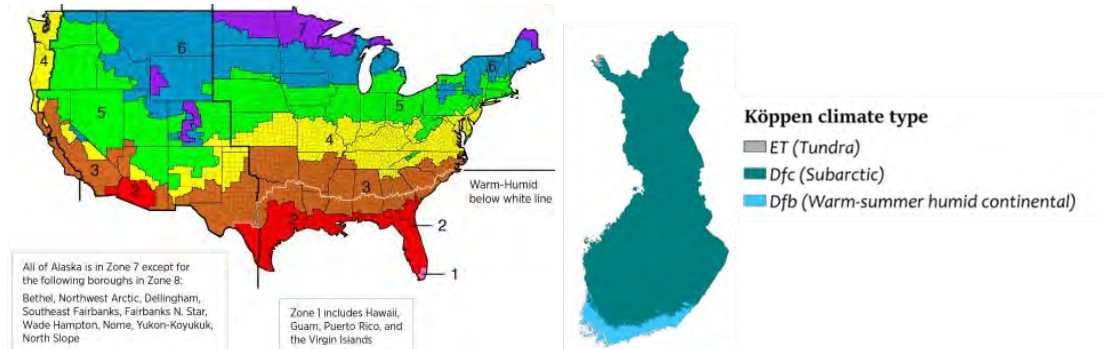

Figure 1: Climate regions in the United States and Finland

Base temperatures are typically defined for a particular building as a function of the temperature that the building is heated to, and different base temperatures may reflect different typical levels of building insulation (U-values). For example, a day with a mean temperature of 4°C (40°F) has 25 HDD in the U.S. (using an 18°C base temperature), but if we use the Finnish base temperature of 17°C, then we should count fewer HDD, at 22.6. In Finland there are fewer HDD (4,323) than in the U.S. (5,400 for a cold climate and 9000 for very cold climate).

In this study, due to the similarities in climate condition and commonalities of building characteristics, we compared multifamily retrofitted buildings in Finland with those in cold and very cold climate regions in the U.S. The first commonality is an aging infrastructure. As illustrated in Figure 2, 54% of Finnish buildings were built before 1980, many built without specific energy performance criteria as there were no building energy regulations in Finland prior to 1976 (Hirvonen et al., 2019). Compared to Finland, the MFBs in the U.S. are even older: 61.5% of buildings nationwide were built before 1980. The first U.S. building energy regulations (ASHRAE 90.1) were published in 1975 (ASHRAE).

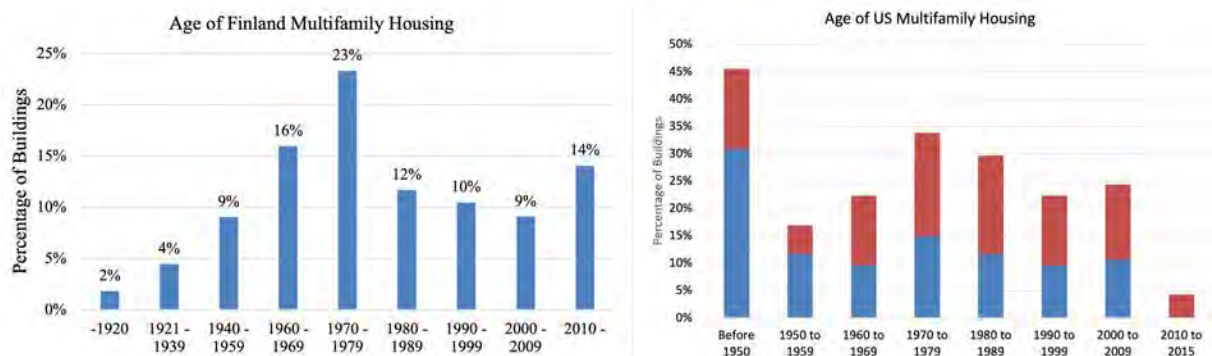

Figure 2: Percentages of multifamily housing built each decade in Finland and the U.S.

The second commonality between the two countries is the building construction type and buildings' physical characters: typical Finnish MFBs are low-rise to mid-rise buildings; 70% of the buildings are larger with three to nine stories, and the remaining 29% of buildings are smaller with one to two stories. In the U.S., the ratio is similar; large MFBs account for 68% (≥ 5 units) and small MFBs make up the rest 32% (two to four units.) In addition, a large proportion (40%) of U.S. MFBs are made of brick, while most Finnish apartment buildings are built using concrete elements (Lehtinen et al., 2015).

Given that a large proportion of MFBs in the United States and in Finland are more than 30 years old, they require renovation and upgrades soon. In addition, these older buildings were built prior to building energy efficiency regulations being initiated. Therefore, these existing MFBs represent a great potential for energy savings and a carbon emissions reduction. A better understanding of what renovation techniques are more effective can provide insights and direction for future renovations.

U.S. MFB character data were downloaded from two resources: the Residential Energy Consumption Survey 2015 database managed by the EIA and the American Housing Survey 2019 database managed by the U.S. Census Bureau. The energy use data were downloaded from RECS 2015, which includes around 10.6 million residential buildings in the cold and very cold climate regions. The Finnish MFB character data and energy use data were downloaded from the Statistics Finland database, which includes close to 1.4 million residential buildings.

3.0 FINDINGS

3.1 Existing MFB stock comparisons

In Finland, multifamily apartment buildings account for 21% of total floor area of all buildings (Statistics Finland) and are responsible for 17% of the total heating energy use and 26% of carbon emissions (Energia 2019). In the U.S., multifamily apartment buildings count for 12% of the total floor area and are responsible for 10% of the energy use in the residential sector (EIA, Table CE1.1). In Finland, the average size of a unit in a multifamily apartment building is 53.6 m² with an average 1.6 persons per household (Statistics Finland). The average energy use for space heating alone is around 150–170 kWh/m² (Paiho et al. 2015), and heating accounts for nearly 68% of total energy use in residential buildings (Statistics Finland 2018). Therefore, the total average energy consumption in Finnish residential buildings is estimated at around 235 kWh/m². In the U.S., the average size of a comparable unit is significantly larger, at 78.87 m² and an average of 2.1 persons per household (EIA, Table HC10.15). The average residential building energy consumption in cold and very cold climate regions in the U.S. is 266 kWh/m² (EIA 2015).

Overall, as illustrated in **Figure 3**, there are five major differences for energy use breakdowns between the two countries. *First*, space heating is the dominant energy end use category (68%) in Finland, while space heating accounts for less than 30% for U.S. residential buildings. The cooling load in Finland is negligible, while the cooling load in the U.S. is 11.8%, even in cold and very cold climates. *Second*, lighting energy use in the U.S. is more than three times higher than that in Finland (7.2% vs 2%). *Third*, some major appliances used in the two countries are different. For example, dishwashers and tumble dryers are common appliances in the U.S.; together, with washing machines, they account for 5% of the total energy use. However, the tumble dryer is not common in a typical Finnish household. Instead, a sauna room in a single-family house and shared sauna facilities in apartment buildings are common amenities in Finland. At the end of 2020, there were 1,319,000 residential buildings and around 1,720,000 saunas in Finland (Statistic Finland). Sauna heating accounts for 5% of total energy use. The *fourth* major difference is other appliance plug loads: in addition to computers and televisions, another 20.8% of energy use is unclassified (identified as "other") in American households, which includes the use of small devices and small kitchen appliances as well as the energy consumption from end uses not captured in the RECS household survey (EIA), hence these are defined as unclassified plug loads. In Finland, all other plug loads (i.e., other electrical equipment) account for 9% of energy use, which is much lower than that in the U.S. The *fifth* major difference is related to energy provision sources in residential buildings. In the U.S., natural gas and electricity are used equally, at 42%, as energy sources in residential buildings [15]. In Finland, the energy sources are electricity (34.5%), district heating (28.5%), and wood (22.2%), while gas accounts for less than 5% of the energy sources (Statistics Finland). Moreover, Finland has a much higher percentage (43%) of energy generated from renewable sources [28], compared to just 11.4% in the U.S. (EIA). In summary, Finland has more clean energy sources than the U.S.

Energy Usage in the U.S Residential Sector in 2015

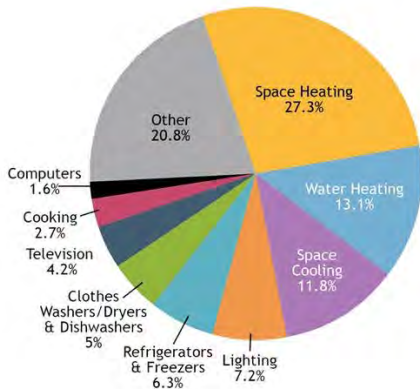

Energy Usage in the Finland Residential Sector in 2018

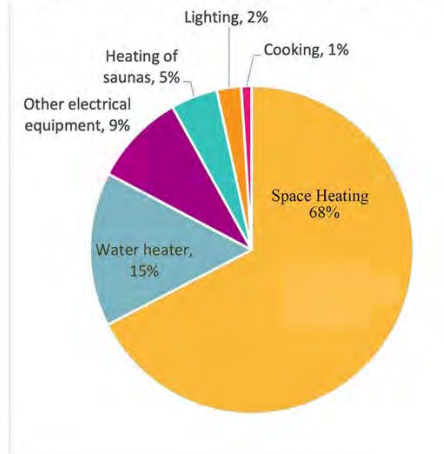

Figure 3 Energy end use breakdown (data based on Statistics Finland, EAI 2015, and the National Academies of Sciences, Engineering, and Medicine)

3.2 Building energy code comparisons

This section focuses on building codes for comparable geographic regions based on climate zones.

3.2.1 Heating degree day difference

Error! Reference source not found.4 illustrates the comparable cold and very cold regions in the U.S. (in blue) that are of a similar climate to Finland. The U.S. design requirement and building code is based on HDD, a measurement used to quantify the demand for energy needed to heat buildings. The HDD is calculated by adding up the differences of the desired indoor and outdoor average temperatures, typically over a one-year period, for the purpose of building energy planning. There are different definitions and calculation methods of HDD that directly contribute to different energy consumption in the two countries (Nord 2017). After close examination, two major differences were identified in the building codes between Finland and the U.S.



Figure 4 Climate regions in the United States and Finland

The first difference is base temperature; in the U.S., HDD is calculated from TMY3 weather data with a base temperature of 18.3°C (65°F) (Menyhart & Krarti 2017). In Finland, the base temperature is lower, at 17°C (62.6°F). Base temperatures are typically defined for a particular building as a function of the temperature that the building is heated to, and different base temperatures may reflect different typical levels of building insulation (U-values). For example, a day with a mean temperature of 4°C (40°F) has 25 HDD in the U.S. (using an 18°C base temperature), but if we use the Finnish base temperature of 17°C, then we should count fewer HDD, at 22.6. The second difference is the days included; in Finland, HDD excludes days when the average temperature is above 10°C (50°F) in the spring and above 12°C (53.6°F) in autumn (Finnish Meteorological Institute). These differences explain why in Finland there are fewer HDD than in the U.S., even though both countries are in similar climate zones. More specifically, in the U.S., the HDD value is 5,400 for a cold climate and 9,000 for a very cold climate (DOE). However, the average HDD value in Finland is 4,323, which is under half of that for the U.S.'s very cold climate average. A higher HDD value normally indicates higher energy demand for heating. The large difference in HDD values does not represent a climatic difference, but reflects the countries' different typical mean building insulation standards (U-values).

3.2.2 Building envelope code requirements

Building energy efficiency can be improved through passive design strategies that include the design of a high-performance building envelope. In recent years, passive design strategies have seen renewed interest for their energy saving potential. A building envelope is the thermal envelope that separates the indoor and outdoor environments of a building, and it includes the exterior walls, roof, floor, and fenestration (window/door). In cold climates, the most used passive building envelope design techniques are adding insulation and reducing glass heat loss. The two building codes compared in this study are the U.S. ASHRAE 90.1 (2016) for climate zone 6 (very cold) and the National Building Code of Finland (by the Finnish Ministry of the Environment). Table 1 lists the basic regulatory requirements for new buildings. Finland has limited the maximum energy that can be consumed in nZEBs, while the U.S. does not have any such limit. In the U.S., there is no separate code for building retrofits; however, if the renovation area is more than 50% of the floor area, then the renovated part should meet the same standards of new construction. In Finland, there are requirements for building energy retrofits (Ympäristöministeriön). Compliance with the requirements can be verified by (1) component-specific improvements, (2) a reduction in energy consumption, or (3) an improvement in the e-value (Green Building Council). Improvements in the energy efficiency of buildings favor active means of targeting ventilation and the heating system. Compliance is thus typically verified based on options 2 or 3.

Regarding option 1, component-specific improvements, Table 1 lists the specific requirements included in the building standard or code in both countries. The allowable U-value (thermal transmittance, W/m^2K) of the thermal envelope is more than twice as high in the U.S. than in Finland, except for the mass timber wall. Higher U-values mean the thermal envelope has less resistance to heat loss. In other Nordic countries, similar thermal envelope standards have also been implemented. For example, in Norway, the most recent national building code, TEK 17, defines the maximum energy use in an MFB as 95 kWh/m^2 , where the U-value is less than 0.18 W/m^2K for the exterior wall, less than 0.13 W/m^2K for roofs, less than 0.1 W/m^2K for floors, and less than 0.08 W/m^2K for windows (Norwegian Building Authority).

Table 1: Building envelope design requirements for new buildings, according to building codes (Ministry of the Environment)

	Max. energy use (kWh/m ²)	Min. energy efficiency criteria ($W/m^2 K$)				
		Wall	Mass timber wall	Roof	Floor/ slab	Window/ door/ skylight
Finland	90	0.12–0.14	0.40	0.07	0.10	0.7
U.S. (for climate zone 6.)	No requirement	0.26	0.34	0.15	0.19	1.82

Note: Mass timber wall is not commonly used for MFBs in both countries.

4.0 Discussion and Conclusion

As illustrated in Figure 6, three categorical factors can impact energy use in buildings: physical factors, human factors, and technical and regulatory factors. The physical factors refer to building physical characteristics, such as compact ratio, building and unit size, and orientation. These physical factors are typically not modified in the energy retrofit projects. Human factors are less predictable, which may also explain the actual energy use variance, though no such data was available in this study. Technical factors refer to the technical variables that have an impact on building energy efficiency. In this study, we have focused on the building service system and building envelope thermal properties. In the building service system, we concentrate on the heating and ventilation system based on the unique cold climate condition. In a cold climate, the space heating demand is typically high, accounting for between 40% and 60% of the total energy use in buildings. Therefore, measures to reduce space heating demand and to deliver the remaining required heating efficiently are typically established in Nordic countries, such as increased insulation, improved triple glazed window performance (Ala-Kotila, 2020), efficient heat recovery ventilation systems (Ng & Payne 2016), and district heating systems (Paiho & Reda 2016). In this study, we focused on combined technical and regulatory factors. The reason we combined the factors is because the requirements of technical factors are often defined in building standards, codes, and national requirements and policies—and changes in regulations can have an immediate impact on building technical factors. For example, in Finland, there is a required maximum energy use intensity allowed; therefore, there is a clear energy performance target and goal for the project, hence all technical variables must work toward meeting the energy performance target. Meanwhile, a lack of requirements in the United States will put less pressure on building teams to optimize the technical design to achieve a higher energy performance goal.

As illustrated in Figure 5, three categorical factors can impact energy use in buildings: physical factors, human factors, and technical and regulatory factors. The physical factors refer to building physical characteristics, such as compact ratio, building and unit size, and orientation. These physical factors are typically not modified in the energy retrofit projects. Human factors are less predictable, which may also explain the actual energy use variance, though no such data was available in this study. Technical factors refer to the technical variables that have an impact on building energy efficiency. In this study, we have focused on the building service system and building envelope thermal properties. In the building service system, we concentrate on the heating and ventilation system based on the unique cold climate condition. In a cold climate, the space heating demand is typically high, accounting for between 40% and 60% of the total energy use in buildings. Therefore, measures to reduce space heating demand and to deliver the remaining required heating efficiently are typically established in Nordic countries, such as increased insulation, improved triple glazed window performance (Ala-Kotila, 2020), efficient heat recovery ventilation systems (Ng & Payne 2016), and district heating systems (Paiho & Reda 2016). In this study, we focused on combined technical and regulatory factors. The reason we combined the factors is because the requirements of technical factors are often defined in building standards, codes, and national requirements and policies—and changes in regulations can have an immediate impact on building technical factors. For example, in Finland, there is a required maximum energy use intensity allowed; therefore, there is a clear energy performance target and goal for the project, hence all technical variables must work toward meeting the energy performance target. Meanwhile, a lack of requirements in the United States will put less pressure on building teams to optimize the technical design to achieve a higher energy performance goal.

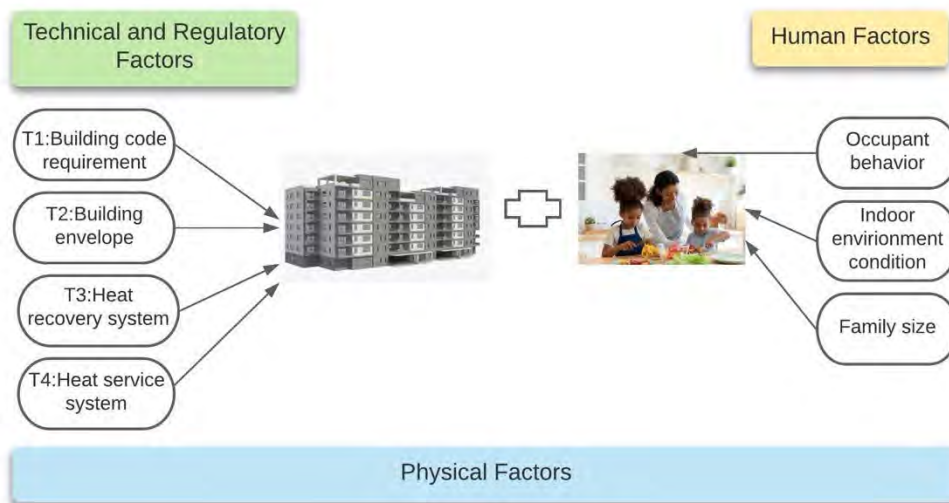

Figure 5: Influential factors that affect building energy use intensity

This paper reviewed different standards and practices in the U.S. and Finland for improving the energy performance of existing residential buildings. The results found that few standards are obligatory in the U.S., while high building standards apply in Finland. This in turn is reflected in the reported energy use of a sample of residential buildings in the U.S. and Finland. The comparison of the Finnish and American buildings showed that good technical practices can be learned from Finland to reduce the heating demand in cold and very cold climate regions of the United States. This includes (1) increasing building envelope thermal properties by adopting higher building energy regulation standards; (2) using a heat recovery ventilation system to recover heat from exhaust air; (3) installing a heat pump, with the main benefits of heat pump systems realized when the heating demand is low in well-insulated buildings; and (4) installing heat recovery ventilation systems.

Compared to Finland and other Nordic countries with more stringent energy consumption requirements, the United States is far behind. To date, the biggest driver for zero energy building in the United States is market demand since there are no nation-wide enforceable regulations or policies to renovate existing buildings to become net zero or nearly zero energy (Hu 2019). Therefore, learning from good practices in Nordic countries can provide timely information for policy makers and designers to make urgent and effective decisions that improve the existing building stock's energy efficiency in cold and very cold climate regions in the United States.

ACKNOWLEDGEMENTS

Finland Fulbright Foundation provided funding to this project. I thank School of Architecture, Planning and Preservation at University of Maryland, Faculty of Built Environment, Tampere University and VTT Technical Research Centre of Finland for their support.

REFERENCES

- Directive 2002/91/EC the European Parliament and of the Council, on the energy performance of buildings, Editor 2002, Official Journal of the European Communities, Brussels.
- European Union. (2018). Directive 2018/844/EU amending the energy performance of buildings and energy efficiency EIA, Table HC10.15 Average square footage of apartment units. accessed January 18, 2021. <https://www.eia.gov/consumption/residential/data/2015/hc/php/hc10.15.php>
- EIA. "Table CE1.3 Summary annual household site consumption and expenditures in the Midwest, 2015." Accessed January 20, 2021. <https://www.eia.gov/consumption/residential/data/2015/c&e/pdf/ce1.3.pdf>
- Energia 2019 (stat.fi). Accessed March 24, 2021. https://pxhopea2.stat.fi/sahkoiset_julkaisut/energia2019/alku.htm
- European Union. (2010). Directive 2010/31/EU on the energy performance of buildings. Official Journal of the European. Accessed June 8, 2021.
- Hu, Ming, and Yueming Qiu. "A comparison of building energy codes and policies in the USA, Germany, and China: progress toward the net-zero building goal in three countries." *Clean Technologies and Environmental Policy* 21, no. 2 (2019): 291-305.
- Department of Energy. "Zero Energy Buildings." Accessed June 8, 2021. <https://www.energy.gov/eere/buildings/zero-energy-buildings>
- Finish Meteorological Institute. "Heating degree days." Accessed January 14, 2021. <https://en.ilmatieteenlaitos.fi/heating-degree-days>
- Green Building Council. "Creating an energy efficient mortgage ofr Europe." Accessed January 20, 2021 https://www.worldgbc.org/sites/default/files/EeMAP_Building_Assessment_Briefing_FINLAND.pdf
- Hu, Ming. *Net zero energy building: Predicted and unintended consequences*. Routledge, 2019.
- Hirvonen, Janne, Juha Jokisalo, Juhani Heljo, and Risto Kosonen. "Towards the EU emissions targets of 2050: Optimal energy renovation measures of Finnish apartment buildings." *International Journal of Sustainable Energy* 38, no. 7 (2019): 649-672.
- Kangas, Hanna-Liisa, David Lazarevic, and Paula Kivimaa. "Technical skills, disinterest and non-functional regulation: Barriers to building energy efficiency in Finland viewed by energy service companies." *Energy Policy* 114 (2018): 63-76.
- Lehtinen, E., Nippala, E., Jaakkonen, L. & Nuutila, H. (2005) Asuinrakennukset vuoteen 2025. Teknologian tutkimuskeskus VTT Oy. http://www.vtt.fi/inf/julkaisut/muut/2005/asuinrakennukset_vuoteen_2025.pdf
- Ministry of the Environment. "The national building code of Finland." Accessed March 03,2021 <https://ym.fi/en/the-national-building-code-of-finland>
- Menyhart, K., & Krarti, M. (2017). Potential energy savings from deployment of Dynamic Insulation Materials for US residential buildings. *Building and Environment*, 114, 203-218.
- Nord, N. (2017). Building energy efficiency in cold climates. *Encyclopedia of Sustainable Technologies*, 149.
- Paiho, S., Seppä, I. P., & Jimenez, C. (2015). An energetic analysis of a multifunctional façade system for energy efficient retrofitting of residential buildings in cold climates of Finland and Russia. *Sustainable cities and society*, 15, 75-85.
- Statistics Finland "Housing." Accessed January 21 https://www.stat.fi/tup/suoluk/suoluk_asuminen_en.html
- Statistics Finland. "Housing - Buildings and free-time residences". Accessed March 24, 2021. https://www.stat.fi/til/rakke/index_en.html
- Statistic Finland. "Housing" accessed January 18, 2021. https://www.stat.fi/tup/suoluk/suoluk_asuminen_en.html#Buildings%20and%20free-time%20residences
- Statistics Finland. "Total energy consumption decreased and consumption of renewable energy grew by one per cent in 2019." Accessed January 21, 2021. https://www.stat.fi/til/ehk/2019/ehk_2019_2020-12-21_tie_001_en.html
- The National Academies of Science. Engineering. Medicine. "Home & Work." Accessed January 21, 2021. <http://needtoknow.nas.edu/energy/energy-use/home-work/>
- The European Portal for energy efficiency in buildings. "Energy efficiency watch report 2013- Finland." Accessed January 27, 2021. <https://www.buildup.eu/en/practices/publications/energy-efficiency-watch-report-2013-finland>
- United States. Energy Information Administration. "Residential energy consumption survey (RECS). Accessed February 20,2021. <https://www.eia.gov/consumption/residential/data/2015/index.php?view=characteristics>

Towards Alternative Live-work Development: An Integrated Design Approach

Christina Payerhofer¹, Mehdi Ashayeri¹

¹Southern Illinois University, Carbondale, IL

ABSTRACT: The current COVID-19 pandemic has challenged human-city interaction from different lenses. People preferred to spend most of their time indoors to protect themselves against diseases. On the other hand, the economic life of cities shifted more toward teleworking to support the economy. Although people commuted less and urban environments became cleaner, it is evident that social detachments and physical and mental health issues deepened due to the stay-at-home action. This requires authorities to rethink live-work spaces and development for future resilient cities. This article is an architectural research-design effort aimed at exploring and envisioning design ideas for a mixed-use live-work structure in a large North American city: Chicago, IL, where a sharp action plan is set to contribute to the sustainability goals by cutting off 80% of greenhouse gas emissions by 2050. This project strives to integrate all three aspects of sustainability, including environmental, social, and economic aspects, particularly bringing healthy (in terms of biophilia and exposure to ambient air pollution), bioclimatic, socially interactive, and economically supportive incentives into the architectural design workflow. In doing so, it applies a hybrid methodology (qualitative and quantitative) that incorporates big data and data-driven methodologies into the design exploration for contextual analysis and employs physics-based performance simulation methods (daylight, solar, and whole building energy modeling) to optimize the initial design. The outcomes of this design-research work can aid architects, designers, and planners in encapsulating three-sustainability aspects for future live-work planning and design, reconnecting occupants to the natural environment, fostering social interaction, boosting the local economy, lowering environmental impacts, and supporting urban resiliency for post-pandemic cities.

KEYWORDS: Live-Work, Biophilic, Bioclimatic, Building Performance, Data-driven, Integrate, Post-pandemic.

INTRODUCTION

Current crises like climate change, social inequity, and human health issues force architects and urban planners to rethink traditional design approaches and strive for more sustainable solutions in the built environment. Along with the growth of the world's population and shrinking resources, cities in particular account for almost 80% of global energy consumption (UN Habitat 2021), contributing to the environmental pollution that affects living conditions in urban environments. Given that the building industry was responsible for 39% of the global energy-related CO₂ emissions in 2018 and building construction and operations accounted for 36% of the global final energy use (Global Alliance for Buildings and Construction, 2019), it is essential to rethink planning and construction strategies to reduce related carbon emissions and support the environment, humans, and the ecology as a whole. Due to the current coronavirus pandemic, new challenges arise as studies show how stay-at-home affected human health as current urban and building designs do not provide such qualities to maintain occupant health and well-being above existing standards. Diseases can spread quickly, especially in populated cities and dense urban areas, making it even more critical to consider resilient and adaptable design approaches at early stages to enable built environments properly functioning while protecting human health.

Human activities, like commuting, are another factor increasing greenhouse gas (GHG) emissions (Almusaed 2011). It is well proven that teleworking can help reduce commuting forces for sustainable goals. Over the last decade, the access to remote work increased by 26%, from 28% to 54% by 2020 (World Economic Forum 2020). In combination with the increasing demand for remote workers and the economic changes caused by the COVID pandemic, teleworking and e-commerce have been becoming increasingly popular (World Economic Forum 2020). The concept of live-work residency supports this trend and offers an architectural solution for new challenges in urban environments (Holliss 2015). Furthermore, live-work spaces significantly impact urban areas by reuniting essential parts of human life and creating a more livable environment by introducing mixed-use neighborhoods and zero-commute living (Dolan 2012). The most significant benefit of the live-work program is saving the cost and time associated with commuting to the workplace. According to the US Census Bureau, Americans spent on average 27 minutes one way commuting to and from work in 2019 (US Census Bureau, 2019). Based on 54 minutes per day, this adds up to 25 workdays (8 hours per day) per year that the average American commutes to reach their work destination. The concept of live-work eliminates this time-waste and saves costs related to public transportation tickets and fuel, which leaves more time and money for free-time activities, promoting a happier and healthier lifestyle (Clark et al. 2020).

Research indicates that people in developed countries spend 90% of their time indoors and have become an indoor generation (European Commission 2003). Daily life, including work, school, and free time, is predominately organized inside a single building or complex. Lack of biophilic sense of place, poor air quality, and limited access to natural light are among factors that risk human health. Particularly, in cities with limited access to safe and green outdoor spaces, this leads to a human disconnection from the natural environment (European Commission 2003). This absence of nature in the human environment can lead to various health issues such as depression (Cervinka, Röderer, and Hefler 2011) and reduce work productivity in workplaces (Largo-Wight et al. 2011). In addition, poor indoor air quality conditions are shown to increase the likelihood of different allergies, and asthma and people exposed to high CO₂ levels develop headaches, insomnia, and fatigue (Rasmussen et al. 2017). For example, the excessive time spent inside buildings with poor indoor air quality leads to a health risk called: "sick building syndrome" (SBS). This disease describes the experience of health and comfort problems related to spending time in an indoor environment when no other illness can be identified (OAR United States Environmental Protection Agency 2014). Previously, the World Health Organization (WHO) stated that around 30% of new and remodeled buildings are subject to this issue, suggesting that poor building design heavily influences human health (OAR United States Environmental Protection Agency 2014).

These challenges, affecting the natural and built environments and negatively impacting human health, demand architects and designers to contribute to sustainable goals of cities by collectively addressing social, economic, and environmental needs in the early stage of the design. Sustainability as an overall concept is defined as meeting the needs of the present generation without compromising future generations' abilities to meet their needs (US EPA 2017). The live-work architecture itself can contribute to the goals on how to develop a more sustainable future (Holliss 2015) by unifying these trio components to benefit an individual building program development, offering an architectural solution on these challenges for the current and future built environments.

For environmental sustainability, bioclimatic and biophilic design approaches provide opportunities to develop a healthier and greener building design (Almusaed 2011). Bioclimatic architecture is defined as a design solution that combines sustainability, environmental consciousness, and natural approaches with the characteristics of the site, the local microclimate, and the topography (Almusaed 2011). This approach also considers climate and environmental conditions to achieve thermal comfort inside buildings without relying on mechanical systems (Almusaed, 2011). Biophilic design, on the other hand, addresses human health and wellbeing in the built environment and aims to reconnect occupants to nature. As studies show that merely looking at a picture of nature can restore concentration and enhance mood (Gamble et al., 2014), incorporating biophilic design strategies provide the opportunity to ensure the health and wellbeing of occupants. By integrating these two environmental design approaches along with incorporating social and economical solutions in the design workflow, this study aims to propose a design that reconnects its occupants to nature and reduces the environmental impacts.

1.0 METHODOLOGY

The primary focus of this research-design study is to achieve a framework for a more sustainable built environment by incorporating the trio aspects of sustainability in a design project through the development of urban architecture with a live-work program. In order to establish a successful design based on the quantitative and qualitative approaches, data-driven design methods were applied to the design workflow, aided by an array of performance analysis tools. In doing so, physics-based simulations depicting sun movement, shadow studies, solar radiation incident, and operational energy use intensity (EUI) were used to aid the decision-making process in early design phases. For bioclimatic design decisions, we used the design criteria by Gutiérrez and Hidalgo (Gutiérrez and Hidalgo 2019), and for biophilic design approaches, the *14 Patterns of Biophilic Design* (Browning, Ryan, and Clancy 2014) were applied. Finally, the Living Building Challenge 4.0 (International Living Future Institute 2019) and ASHRAE 90.1 (American Society of Heating, Refrigerating and Air-Conditioning Engineers n.d.) guidelines were used to verify the building performance.

1.1 Research Methodology

For research of existing sustainable design projects, two precedent studies, Bosco Verticale (Stefano Boeri Architetti n.d.) and Genzyme Center (Behnisch Architekten n.d.) were analyzed, and significant findings were implemented into the design of this thesis project. In order to gain a better insight into validating the design of the project, the Living Building Challenge 4.0 (International Living Future Institute 2019) criteria were investigated, and goals for the design's intended LBC certification were defined. Furthermore, the ASHRAE Standard 90.1 (American Society of Heating, Refrigerating and Air-Conditioning Engineers n.d.) was analyzed to investigate established benchmarks for sustainable building design.

1.2. Design Methodology

For the design part of this study, we utilized urban big-data analysis via Tableau, Microsoft Excel, and Mapbox, and building performance analysis (BPA) through Rhino Grasshopper and Autodesk Revit to aid the decision-making process and comply with sustainability goals. For BPA solar radiation indecent (SRI) analysis (Rhino Grasshopper), daylight access analysis (Rhino Grasshopper), and whole-building energy use intensity (EUI) modeling (Autodesk Revit) was performed. Solar radiation is described as "a general term for the electromagnetic radiation emitted by the

sun" (Office of Energy Efficiency & Renewable Energy n.d.). In this project, SRI is used to determine the most optimum building orientation in the site and building form. The kWh/m² is used as a metric to express the amount of solar radiation that reaches the exterior surface of the proposed building and compare different design iterations. Daylight can be described as natural light which enters a building and helps to save energy for lighting or heating. Overall, up to 1/3 of the total energy cost of a building can be saved if proper daylight access is considered in the design (Ander 2016). In this work, the daylight access is analyzed by running a sunlight hour analysis, which shows how many hours of direct sunlight the facade of the building structure receives. These analyses were performed on six volume iterations emerging from an initial form in the early design exploration process. For whole building energy simulation, the Energy Use Intensity (EUI) is a value for the energy efficiency of a building, considering its design and operation. It is used to set building performance targets, benchmark buildings, and evaluate energy code requirements (American Institute of Architects California 2020). We implemented energy modeling during the design development process (detailing phase). The metric was used to compare the proposed design to an established benchmark and validate the performance compared to the Architecture 2030 challenge target.

Using big data, we further measured natural ventilation (NV) potentials for the project based on its geolocation in Chicago, Illinois. The time series hourly data for Air Quality Index (AQI) was captured from Purple Air (PurpleAir n.d.) smart cities' platform and by excluding the hours in which AQI thresholds ("good" air quality = Air Quality Index (AQI) ≤ 50 (AirNow 2021)) could not be met, the number of hours within a year in which NV would occur could be determined. In addition, the hourly data from April to September are analyzed separately to measure how healthy NV would be in the thermally suitable months in Chicago.

2.0 RESULTS AND DISCUSSIONS

2.1. Contextual Studies

In order to propose an energy-efficient, health-promoting design that relies on its context and location, it was essential to choose a city with a wide range of data available. For this reason, the city of Chicago, Illinois, has been selected for the site of this thesis project. In order to get a better insight from the context, the city population characteristics and neighborhood dynamics were analyzed. By choosing to design a live-work building, the main factors considered in selecting a site were public transportation access and the proximity to everyday destinations. Located in Near West Side, in an area called West Loop Gate, the proposed land site is centrally situated within the neighborhoods of Greek Town, Fulton Market, and the Chicago Loop. The surrounding area's land use is an even distribution of residential, commercial, and office buildings. In general, the site is located within a transition zone of low- to mid-rise buildings to the West and the high-rise structures towards the East and downtown area.

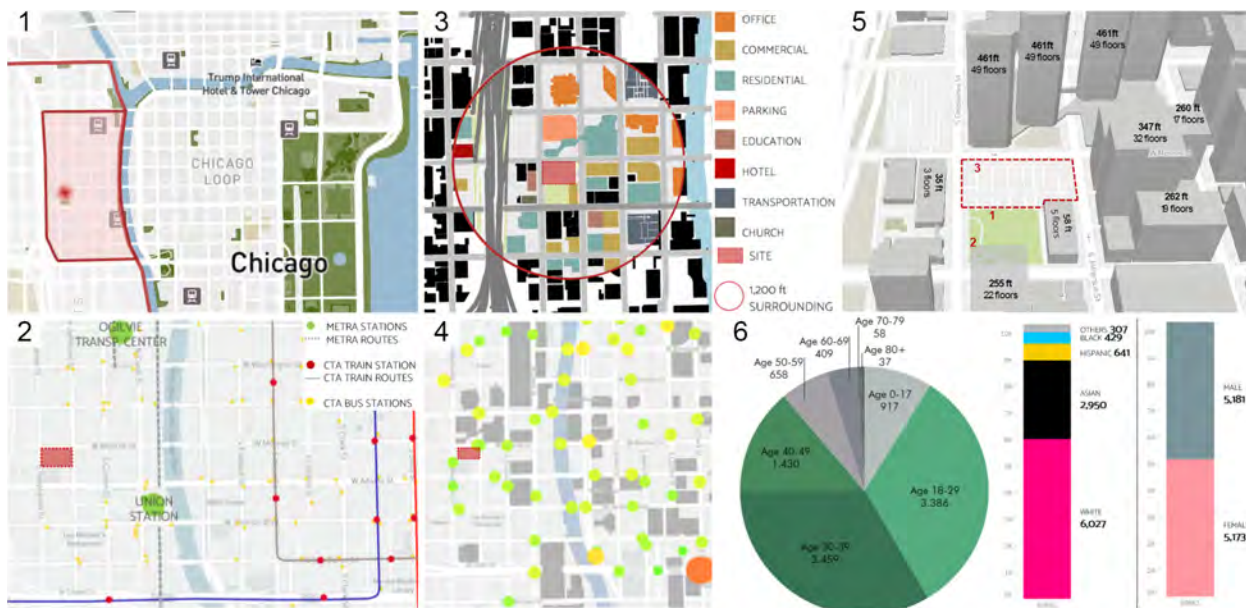

Figure 1: Site Location in West Loop Gate (1), Public Transportation related to Site (2), Surrounding Land Use (3), Traffic Count (4), Site in Surrounding Context (5), Age Groups and Demographics in West Loop Gate (6). Mapbox and Tableau software was used to visualize the data.

2.2. Program

The Chicago Building Code defines live-work units as "A *dwelling unit* in which a significant portion of the space includes a nonresidential use that is operated by a resident." (American Legal Publishing Corporation 2021). Whether those

units are lofts, including workspaces or workspaces with an additional living area, this program concept is based on the union of two significant aspects of human life (Dolan 2012). Current technology allows people to work as effectively from home as from an office space, and sustainable considerations like less car traffic since people do not have to commute to work are pushing concepts for this building type (Dolan 2012). Especially since the COVID pandemic, more people work from their homes, and live-work units offer great possibilities for employers and employees to plan for upcoming challenges (World Economic Forum 2020).

The program of the project proposes live-work units within a building that offers leisure time activities and everyday destinations to minimize commuting and create a lively neighborhood fostering a sense of community. The proposed building program is divided into 40% live-work units, 37% amenity spaces, 18% public spaces, and around 5% Back of House area (Table 1). In order to accommodate different user groups, the live-work units consist of four different types: studio/lofts, one-bedroom units, two-bedroom units, and co-living/co-working units as an alternative live-work concept. Biophilic design strategies and high exposure to the outdoor environment are incorporated into the design of all units to improve life quality and work productivity and ensure occupants' health and wellbeing. In order to promote interaction and a sense of community, the program includes an abundance of amenity areas like co-working and maker spaces. Furthermore, the program includes recreation areas like a fitness center, an indoor pool area, and SPA treatment facilities. By incorporating public spaces like a food market, a hairdresser, a coffee shop, and a restaurant into the building program, daily uses are provided within proximity.

Table 1: Building Program and size of all spaces in square foot.

Spaces With Dedicated Areas	*Net Area	Gross Area	Spaces With Dedicated Areas	Quantity	Net Area	Gross Area
PUBLIC AREAS			BACK OF HOUSE			
Lobby (incl. Mail area)	7846	9230	Administration/Staff		4240	5300
Food and Beverage Outlet	4076	4795	Food Preparation / Storage		2800	3500
Retail	11148	13115	Receiving and storage		1480	1850
Hairdresser	1326	1560	Janitor		240	300
Rentable multi-purpose Spaces	11734	13805	Laundry and housekeeping		1120	1400
Public Restrooms	3655	4300	Trash/Recycling area		1496	1870
Bike Workshop	497	585	Mechanical		2960	3700
Vehicular Parking	12997	15290	Tot. net BOH area		14336	
Tot. net public area	53278		Total gross area (+20%)			17920
Tot. gross area (+15%)		62680	LIVE - WORK UNITS			
AMENITY AREAS			Studio / Loft	30	715	25740
Coworking / Maker Spaces	35301	41530	One-Bedroom	40	770	36960
Community Lobbies	67065	78900	Two-Bedroom	50	970	58200
Fitness Center	1785	2100	Co-living / Coworking	10	1600	19200
Indoor Pool Area	5317	6255	Number of Units	130		
Spa Treatment	680	800	Net area		116750	
Tot. net amenity area	110147		Gross area (+20%)			140100
Total gross area (+25%)		129585	TOTAL GROSS AREA			
			VERTICAL CIRCULATION %10			
			TOTAL			
			350285			
			35029			
			385314			

*All areas are in square foot unite

2.3. Design exploration process

The initial design idea for this study was to create a building structure that promotes health and wellbeing for occupants while transforming its surroundings into a more live-able, community-oriented, and greener urban environment near downtown Chicago. Situated next to an existing park, the design goal was to transition this green space into the new building and create an abundance of nature-like outdoor spaces on various levels. The master plan concept merges two high-rise towers with a broad base covering the entire site. Placing slender towers upon a wide multifunctional base creates a clear horizontal layering of different privacy degrees and user-group typologies (Sim 2019). This concept of layering is also applied to the organization of the towers, offering changing characters between private and semi-private floors as occupants move up and down in the building. Skybridges connecting both towers should promote interactive building use and encourage encounters between neighbors (“Linked Hybrid / Steven Holl Architects” 2009).

After the initial form-finding process (Figure 2), a set of iterations was performed. Six iterations performed after the base model were analyzed through SRI on building external surfaces and sunlight access analyses to determine which iteration allows maximum solar exposure, positively influencing the building’s solar and lighting performance. Although the iterations of volume 01 result in a higher SRI value than volume 02, the decision was made to work further on volume 02 and to develop the final form by implementing shifting edges and cut-outs into the volume to achieve a

higher SRI value. This final decision illustrates that those different parameters (site context, shadow studies, architectural value) aside from solar radiation must be considered for a comprehensive design approach. By integrating the results of the solar analysis with these parameters, the final form was developed and used as a base for further building planning.

For understanding indoor health based on ambient IAQ assessment, we used data-driven and big data approaches. Through filtering and screening obtained data, we found that only 9.3% of the hours per year (in 2019) meet AQI necessary for acceptable ambient air quality, indicating that NV potential for the site is not significant.

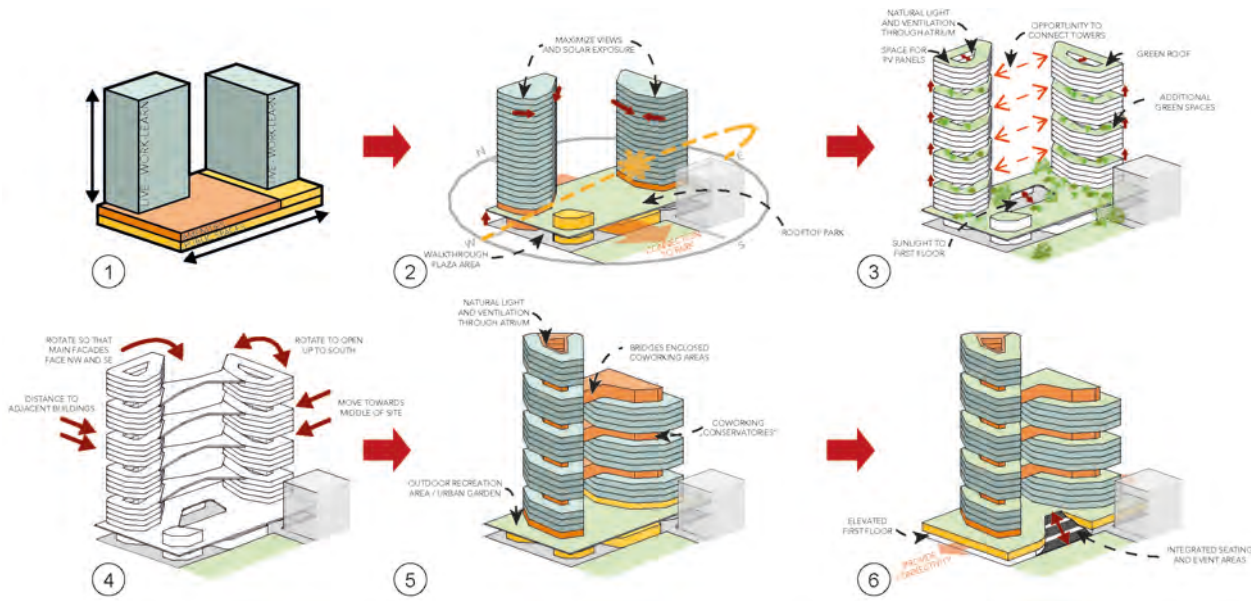

Figure 2: Initial Form-Finding Process.

Table 2: Morphological Optimization through comparison of obtained SRIs.

Iteration	01	01.1	01.2	01.3	02	FINAL
Action	Western tower heightened	Roofs sloped	Edges shifted	Cut-outs implemented	Heightened eastern tower	Combined 02, 01.2, and 01.3
SRI (kwh)	1.5016 e+7	1.4878 e+7	1.5362e+7	1.5398e+7	1.4509e+7	1.4782e+7

2.4. Design development

The masterplan concept integrates various programs in one building structure, allowing for a mixed-use concept and different user typologies. Furthermore, a comprehensive approach unifies the ability to solve the challenges of the live-work program while addressing social, economic, and environmental sustainability. One of the main design goals was to redevelop the existing park adjacent to the building site and transmit the green space into the building design by offering outdoor green spaces on various levels for different user groups. In order to make the high-rise towers more walkable and promote interaction between building occupants, community and coworking spaces are located on every fourth floor, creating a layering of privacy degrees throughout the building. The surrounding infrastructure makes the site equally accessible by walking, biking, and car. Due to the goal of providing safe and walkable spaces for pedestrians, the site itself is solely for walking with bike parking facilities for bikers and a pick-up/drop-off area as well as underground parking access for vehicle users. Additional service roads at the back of the building allow for functional loading and unloading procedures. Figure 6 illustrates a number of final renderings for the design.

2.5. Incorporated bioclimatic and biophilic concepts

The bioclimatic design focuses on reducing or avoiding these harmful effects caused by the built environment's construction and operation. Gutiérrez and Hidalgo (Gutiérrez and Hidalgo 2019) established a guideline on using natural elements for a more sustainable design and pointed out that architects and planners must understand that buildings always stand in a relationship with the natural environment and interact with it. Therefore, it is fundamental to take advantage of the benefits of the following five natural elements when designing a more sustainable built environment: Earth, Living Elements, Air, Sunlight, and Water. Biophilic design approaches provide a second objective when aiming for an overall sustainable design concept. Promoting positive interaction between people and nature in the built environment is necessary to achieve a restorative environmental design that goes beyond reducing harmful effects on the environment and takes the dependence of human contact to nature into consideration. Browning, Ryan, and Clancy established the 14 Patterns of Biophilic Design and classified the patterns into three categories. These categories are Nature in the space, Nature of the Space, and Natural Analogues. Their approach describes the relationships between nature, human biology, and the built environment design and helps to understand how biophilic design can be incorporated into a building's design (Browning, Ryan, and Clancy 2014).

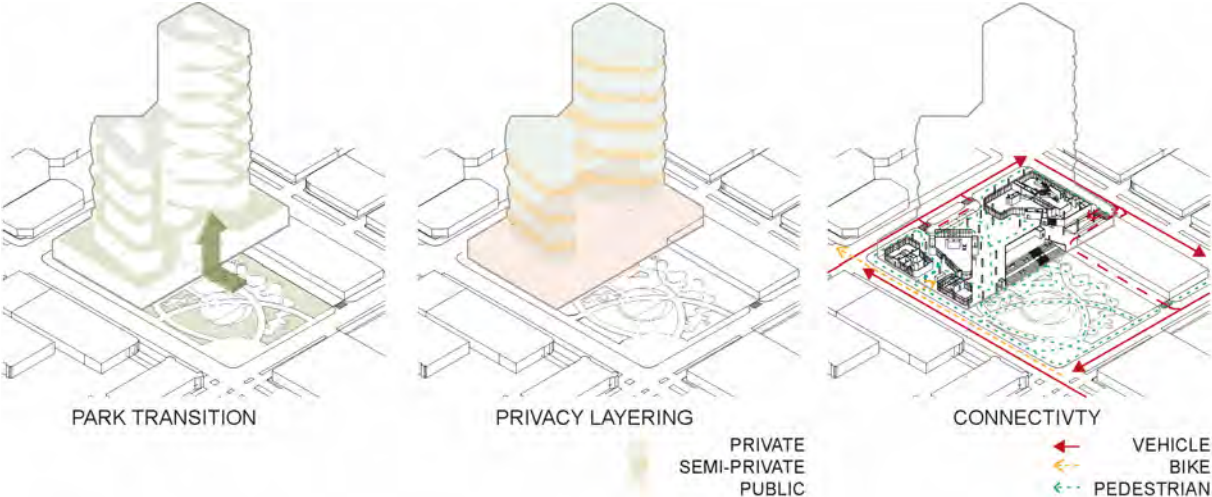

Figure 3: Masterplan Development Diagrams.

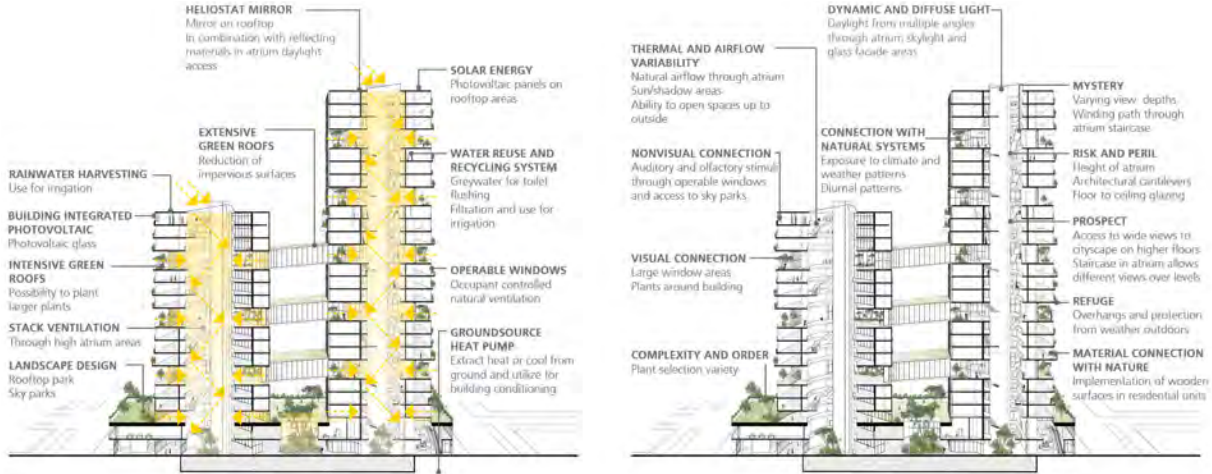

Figure 4: Integrated Bioclimatic (left) and Biophilic (right) Concepts.



Figure 5: EUI Calculations and Established Benchmark Using Autodesk Insight and Zerootool

2.5. Final Building Performance Analysis

For EUI analysis, the program Autodesk Revit and Autodesk Insight was used to calculate an EUI of 82.5 kBtu/ft²/yr for the base model. After adjusting the building’s parameters according to suggestions by the program, this value could be decreased to 35.3 kBtu/ft²/yr. Since there is no established baseline EUI for an equivalent building, the website zerotool.org was used to calculate such and compare the model to a benchmark. The target for Architecture 2030 with a 70% EUI reduction was set as 20 kBtu/ft²/yr by the tool (Figure 5). Table 3 lists parameters that we changed from base to their optimum values in order to reduce the EUI of the design.

Table 3: EUI Optimization Parameters Captured from the Autodesk Insight Software.

Parameters	Base EUI	Optimized EUI	Parameters	Base EUI	Optimized EUI
Daylight / Occupancy cntl	none	added	Window Glass	default	Trp LoE
HVAC	default	high efficiency heat	Window Shades	default	2/3 window height
Infiltration	default	0.17 ACH	WWR* East	41%	40%
Lighting Efficiency	default	basic	WWR West	56%	50%
Plug Load Efficiency	default	0.6 W/sf	WWR North	77%	65%
Roof Construction	default	10.25-inch SIP	WWR South	60%	40%
Wall Construction	default	R13 + R10 metal			

*Window to wall ratio

CONCLUSION

The main objective of this research design project was to develop an alternative approach for live-work architecture, addressing the trio aspects of sustainability: society, economy, and environment. Another goal for the framework was to establish a design proposal that meets the criteria of the Living Building Challenge 4.0 by incorporating bioclimatic and biophilic design considerations to reduce the adverse effects of buildings on the natural environment and promote health and wellbeing in the built environment. The results illustrate the design process and proposal influenced by a combination of comprehensive research regarding the characteristics of the live-work program and sustainable design approaches and the outcomes of computer-aided analysis and traditional architectural practices. The design proposal addresses all three aspects of sustainability in reference to the six main dimensions established for the three categories by the US EPA (US EPA 2015). For social sustainability, the design creates a living environment that promotes the health and wellbeing of occupants. Furthermore, community and coworking spaces distributed through the high-rise towers promote human interaction and neighborhood while helping to make the building more walkable. For economic sustainability, the program includes new businesses like restaurants, a food market, and a hairdresser to strengthen the local economy and create job opportunities in the neighborhood. Regarding environmental sustainability, bioclimatic design considerations and designing with the five elements of sustainable architecture aim to protect the health of the natural ecosystem in an urban environment. Furthermore, by incorporating renewable energy sources, pollution and GHG emissions can be reduced, leading to achieve better air quality in urban environments.

Addressing current challenges like urbanization and climate change, it is crucial to positively impact future cities and create healthy urban environments for people. This paper illustrates an architectural design solution that develops a hypothetical vertical urban architecture in Chicago, IL. By applying a hybrid methodology (qualitative and quantitative) and using big data, and data-driven methods, energy-efficient and performance-driven design were integrated with the architectural design workflow. The current work examined an alternative idea for developing live-work spaces capable of reconnecting occupants to the natural environment, fostering social interaction, supporting the local economy, and lowering environmental impacts for the future urban environment. Future studies and design proposals in the area of live-work could extend the study into a larger urban scale and further investigate how the benefits of the program can transform conventional city planning and support more sustainable urban environments.



Figure 6: Aerial and Perspective Renderings.

ACKNOWLEDGEMENTS

Christina Payenhofer: conceptualization; methodology; software; formal analysis; investigation; data curation; writing original draft; visualization. Mehdi Ashayeri: conceptualization; investigation; resources; writing (review and editing); supervision; project administration.

REFERENCES

- AirNow. 2021. "AQI Basics." Airnow.Gov. AirNow.gov, U.S. EPA. 2021. <https://www.airnow.gov/aqi/aqi-basics>.
- Almusaed, Amjad. 2011. *Biophilic and Bioclimatic Architecture: Analytical Therapy for the Next Generation of Passive Sustainable Architecture*. London: Springer-Verlag. <https://doi.org/10.1007/978-1-84996-534-7>.
- American Institute of Architects California. 2020. "Energy Use Intensity (EUI)." 2020. <https://aiacalifornia.org/energy-use-intensity-eui/>.
- American Legal Publishing Corporation. 2021. "14B-2-202 Definitions." American Legal Publishing Corporation. 2021. https://codelibrary.amlegal.com/codes/chicago/latest/chicago_il/0-0-0-2579257.
- American Society of Heating, Refrigerating and Air-Conditioning Engineers. n.d. "ANSI/ASHRAE/IES Standard 90.1-2019 - Energy Standard for Buildings Except Low-Rise Residential Buildings." ASHRAE. Accessed June 18, 2021. <https://www.ashrae.org/technical-resources/bookstore/standard-90-1>.
- Ander, Gregg A. 2016. "Daylighting." Whole Building Design Guide. 2016. <https://www.wbdg.org/resources/daylighting>.
- Behnisch Architekten. n.d. "Genzyme Center." Behnisch Architekten. Accessed June 8, 2021. <https://behnisch.com/work/projects/0104>.
- Browning, William, Catherine Ryan, and Joseph Clancy. 2014. *14 Patterns of Biophilic Design: Improving Health and Well-Being in the Built Environment*. New York: Terrapin Bright Green, LLC. <https://www.terrapinbrightgreen.com/report/14-patterns/>.
- Cervinka, Renate, Kathrin Röderer, and Elisabeth Hefler. 2011. "Are Nature Lovers Happy? On Various Indicators of Well-Being and Connectedness to Nature." *Journal of Health Psychology* 17 (August): 379–88. <https://doi.org/10.1177/1359105311416873>.
- Clark, B., K. Chatterjee, A. Martin, and A. Davis. 2020. "How Commuting Affects Subjective Wellbeing." *Transportation* 47 (December): 2777–2805. <https://doi.org/10.1007/s11116-019-09983-9>.
- Dolan, Thomas. 2012. *Live-Work Planning and Design : Zero-Commute Housing*.
- European Commission. 2003. "Indoor Air Pollution: New EU Research Reveals Higher Risks than Previously Thought." Text. European Commission - European Commission. 2003. https://ec.europa.eu/commission/presscorner/detail/en/IP_03_1278.
- Global Alliance for Buildings and Construction. 2019. "2019 Global Status Report for Buildings and Construction: Towards a Zero-Emission, Efficient and Resilient Buildings and Construction Sector." <http://wedocs.unep.org/bitstream/handle/20.500.11822/30950/2019GSR.pdf?sequence=1&isAllowed=y>.
- Gutiérrez, Rosa Urbano, and Laura de la Plaza Hidalgo. 2019. *Elements of Sustainable Architecture*. London: Routledge. <https://doi.org/10.4324/9781351256445>.
- Holliss, Frances. 2015. *Beyond Live/Work : The Architecture of Home-Based Work*. Taylor & Francis Group. <https://ebookcentral.proquest.com>.
- International Living Future Institute. 2019. *Living Building Challenge 4.0 Standard*. https://www2.living-future.org/LBC4.0?RD_Scheduler=LBC4.
- Largo-Wight, Erin, W. William Chen, Virginia Dodd, and Robert Weiler. 2011. "Healthy Workplaces: The Effects of Nature Contact at Work on Employee Stress and Health." *Public Health Reports* 126 (Suppl 1): 124–30.
- "Linked Hybrid / Steven Holl Architects." 2009. ArchDaily. September 9, 2009. <https://www.archdaily.com/34302/linked-hybrid-steven-holl-architects>.
- OAR United States Environmental Protection Agency. 2014. "Indoor Air Facts No. 4 Sick Building Syndrome." Overviews and Factsheets. US EPA. August 18, 2014. <https://www.epa.gov/indoor-air-quality-iaq/indoor-air-facts-no-4-sick-building-syndrome>.
- Office of Energy Efficiency & Renewable Energy. n.d. "Solar Radiation Basics." Energy.Gov. Accessed June 8, 2021. <https://www.energy.gov/eere/solar/solar-radiation-basics>.
- PurpleAir. n.d. "Real-Time Air Quality Map." PurpleAir. Accessed June 20, 2021. <https://www.purpleair.com/map?opt=1/mAQI/a10/cC0&select=5588#12.91/41.87868/-87.63974>.
- Sim, David. 2019. *Soft City: Building Density for Everyday Life*. Washington DC, USA: Island Press.
- Stefano Boeri Architetti. n.d. "Vertical Forest." *Stefano Boeri Architetti* (blog). Accessed December 9, 2021. <https://www.stefano-boeri-architetti.net/en/project/vertical-forest/>.
- UN Habitat. 2021. "Cities and Pollution." United Nations. United Nations. 2021. <https://www.un.org/en/climatechange/climate-solutions/cities-pollution>.
- US Census Bureau. 2019. "Average Travel Time to Work in the United States by Metro Area." The United States Census Bureau. 2019. <https://www.census.gov/library/visualizations/interactive/work-travel-time.html>.
- US EPA. 2015. "Sustainability Primer." https://www.epa.gov/sites/production/files/2015-05/documents/sustainability_primer_v9.pdf.
- US EPA, ORD. 2017. "Sustainability and the ROE." Overviews and Factsheets. US EPA. November 1, 2017. <https://www.epa.gov/report-environment/sustainability-and-roe>.
- World Economic Forum. 2020. "The Future of Jobs Report 2020." <https://www.weforum.org/reports/the-future-of-jobs-report-2020/>.

Machine Learning-Based Automated Thermal Comfort Prediction: Integration of Low-Cost Thermal and Visual Cameras for Higher Accuracy

Roshanak Ashrafi¹, Mona Azarbayjani¹, Hamed Tabkhi¹

¹University of North Carolina at Charlotte, Charlotte, NC

ABSTRACT: Recent research is trying to leverage occupants' demand in the building's control loop to consider individuals' well-being and the buildings' energy savings. To that end, a real-time feedback system is needed to provide data about occupants' comfort conditions that can be used to control the building's heating, cooling, and air conditioning (HVAC) system. The emergence of thermal imaging techniques provides an excellent opportunity for contactless data gathering with no interruption in occupant conditions and activities. There is increasing attention to infrared thermal camera usage in public buildings because of their non-invasive quality in reading the human skin temperature. However, the state-of-the-art methods need additional modifications to become more reliable. To capitalize potentials and address some existing limitations, new solutions are required to bring a more holistic view toward non-intrusive thermal scanning by leveraging the benefit of machine learning and image processing. This research implements an automated approach to collect and register simultaneous thermal and visual images and read the facial temperature in different regions. This paper also presents two additional investigations. First, through utilizing IButton wearable thermal sensors on the forehead area, we investigate the reliability of an in-expensive thermal camera (FLIR Lepton) in reading the skin temperature. Second, by studying the false-color version of thermal images, we look into the possibility of non-radiometric thermal images for predicting personalized thermal comfort. The results shows the strong performance of Random Forest and K-Nearest Neighbor prediction algorithms in predicting personalized thermal comfort. In addition, we have found that non-radiometric images can also indicate thermal comfort when the algorithm is trained with larger amounts of data.

KEYWORDS: Thermal comfort, Thermal preference prediction, Machine learning, Infrared Thermal Images

INTRODUCTION

Most people spend over 90% of their time indoors in modern society, causing indoor environmental qualities to significantly influence our health conditions. In this regard, The World Health Organization (WHO) had emphasized the importance of our living place as one of the Social determinants of Health (SDOH), which is defined as "The conditions in which people are born, grow, live, work and age" ("WHO | Social Determinants of Health" 2015). The building sector alone consumes about 40% of global produced energy. Of this amount, the majority is used to provide comfortable interior conditions for building occupants. However, people are still largely dissatisfied with their environmental comfort (Administration and Analysis 2014). Despite several energy-based and hi-tech building systems that are used in recent buildings specially shared open spaces, occupants' comfort level has not been satisfactory (Ashrafi et al. 2019; Mostafavi et al. 2018). This becomes of more importance when we are considering long-term occupancy levels such as office environments (Zarrabi et al. 2018; Armin Amirazar et al. 2018). The recent research regarding the Sick Building Syndrome (SBS) has increased attention to the effect of the built environment on the occupant's health condition, especially at long-term occupancy. It has been proven that temperature and humidity conditions are great contributors to SBS, including fatigue, headache, and susceptibility to cold and flu (Ghaffarianhoseini et al. 2018). Concerning office buildings, lost productivity, decreased performance, and sick absences are causing the most significant losses among environment-related symptoms, which cost businesses around \$20 to \$70 billion annually. The financial reimbursements of workplace environment improvement were estimated at around \$5 to \$75 billion annually, resulting in health benefits for more than 15 million workers (Mendell et al. 2002). The Indoor Environmental Quality (IEQ) factors are significant contributors to an office building's comfort and productivity, a combination of thermal, visual (A. Amirazar et al. 2018), acoustics, space layout, and air quality. By understanding the contributing IEQ factors on occupants' comfort, we will improve human well-being and productivity. In this regard, the thermal condition is one of the main contributing factors to SBS, which needs to be studied and improved.

One of the main problems of the buildings' controlling systems is generalized thermal comfort models that have caused discomfort, dissatisfaction, and health-related issues for many building occupants in the indoor space (Shahzad et al. 2017). Most of the current building controlling systems that rely on these explicit pre-defined models of occupant

behavior do not correspond to different occupants' actual comfort in the environment. Predicted Mean Vote (PMV) and Adaptive Comfort are the two most common models for controlling indoor thermal conditions. These two models are defined to predict the average thermal comfort of a large population, which has resulted in the uncertainty of these models. As building control systems are currently using these general standards to predict the average thermal comfort of a large population, they are expected to provide comfort for approximately 80% of the building occupants. However, a 10-year-long study of 52,980 occupants in 351 predominantly North American office buildings has shown that only 2% of these buildings provide thermal comfort for 80% of their occupants (Karmann et al., 2018). The large numbers of unhealthy buildings and unsatisfied occupants have made researchers study the validity of the currently used general standards such as PMV. Human attributions such as age, gender, and metabolic rate may affect these preferences. In addition, because the room may be used for different purposes or tasks, occupants and their choices regarding thermal comfort may alter. Along with the physiological characteristics, psychological aspects play a crucial role in a human's mood. Tiredness or emotional status (being happy or angry) and stress level can also influence people's subjective thermal sensation (Hong et al., 2017). This makes it impossible to consider people's differences in thermal preference and the importance of each contributing factor for the individuals by simply relying on general standards (Ruoxi Jia et al. 2018).

Recent research is developing the notion of personalized comfort by attempting to leverage occupants' demand in the control loop of buildings to consider the well-being of each individual based on their personal physiological properties. Therefore, a real-time feedback system is needed to provide data about occupants' physiological conditions that can control the building's heating, cooling, and air conditioning (HVAC) system. Personalized comfort is a recent concept in the building design area that provides comfortable conditions for each occupant based on their preferences. The innovations in environmental data gathering have provided an excellent opportunity to collect large amounts of information from the buildings' occupants, which can be studied to improve a building's control conditions. In this regard, the emergence of thermal imaging techniques makes contactless data gathering possible without any interruption in occupant conditions and activities.

In this research, we are looking into the possibility of using low-cost thermal cameras as a cost-effective vision-based method for automated data gathering of occupants' thermal conditions. In addition, this research creates a fully automated platform for a more precise reading from larger distances, which makes it an excellent fit for real-time applications in the actual world. This is completed by leveraging simple visual (RGB) and thermal cameras to create a multimodal sensing platform. Through this integrated system, we will use visual cameras to localize facial areas (e.g., forehead, cheeks, nose) while using thermal cameras to measure the thermal values of those areas, thus enhancing the accuracy and robustness of sensing and measurement. These features would make this approach optimal to be used in multi-occupancy spaces such as office environments. The study has two main contributions: First, an automated personalized thermal comfort prediction model is developed by integrating low-cost thermal and visual cameras. Second, the prediction accuracy of different variables, including thermal infrared skin temperature, thermal image pixel intensity, and wearable sensors, are compared with each other.

The rest of this paper has three main sections in section 1. Literature Review looks into the conventional comfort models and the current state-of-the-art research on personalized thermal comfort. Section 2 explains our data collection and analysis methodology, and the results are presented and analyzed in Section 3.

1.0 Literature Review

This section will summarize current thermal comfort models and alternative approaches to taking into account the preferences of building occupants. Finally, we will discuss infrared imaging as a non-contact method for collecting human-centric data and successful research.

The Predicted Mean Vote (PMV) is a widely used model for assessing thermal comfort that Fanger developed in 1960 to represent the average thermal sensation vote of a large group of people (Cheng, Niu, and Gao 2012). This model was created based on the difference between generated heat and released heat from the human body and its correlation with the subjective perception of comfort. Since the PMV model was developed in a chamber setting within an air-conditioned space, the results are expected to differ in natural settings and naturally ventilated buildings. Previous research backs up this model for higher quality performance results in natural ventilation buildings (Rupp, Vásquez, and Lamberts 2015) (Humphreys and Fergus Nicol 2002). A PMV model was initially developed to predict the thermal sensation of groups of people. However, the prediction accuracy for groups of people was not acceptable in several studies (Cheung et al. 2019). The PMV model's only acceptable prediction was in neutral conditions within the range of 0.25, as bias was shown in both sides of the cool and hot sensations, with poorer performance on the cool side (Humphreys and Fergus Nicol 2002; Cheung et al. 2019). In several studies, the PMV factor performed poorly in both individual and group level predictions of thermal sensation compared to observed thermal sensation. The leading cause of this inaccuracy is a variety of individual differences resulting in different thermal preferences that were not considered in the PMV calculation. The PMV model's low accuracy raises concerns about using it to control our buildings.

The Human-in-the-loop (HITL) concept has redefined the relationship between humans and their surrounding environments controlling systems. To achieve a high-performance building throughout the operation phase, embracing subjective human aspects in the control loop is necessary. Providing the desired temperature set point to minimize discomfort among all occupants is an important yet challenging problem. HITL methods enhance building management performance to take advantage of users' feedback and receive an adaptive model at each iteration. The Internet of Things (IoT) is a recent technology that facilitates communication between gadgets and building inhabitants. Buildings with IoT technology employ a real-time monitoring system to make this task viable. IoT-based systems and HITL techniques enable device-to-device connectivity and data exchange for sensing, actuation, and control (Ray 2018) An efficient IoT system requires data-

gathering devices that offer real-time feedback to the controlling loop. Sensors can collect data on both the environment and the occupants' physiological state. These data collection devices can either be intrusive or non-intrusive to building inhabitants. The rapid advancements in environmental data collection have created an invaluable opportunity for amassing large amounts of data that may be evaluated to improve the quality of our interior environment. The majority of current HITL research uses occupancy-based models that rely entirely on occupancy detection techniques such as motion, visual representation, location, and the usage of devices to create schedules and regulate thermal conditions. Other research uses direct feedback from occupants to control conditions using the voting and physiological sensing systems(Jung and Jazizadeh 2018). In participatory sensing systems, thermal scale preferences quantify comfort(Jazizadeh, Marin, and Becerik-Gerber 2013; Erickson and Cerpa n.d.). These intrusive voting systems require constant feedback from the occupants. Use wristbands to collect physiological and environmental data to predict each occupant's comfort(Dai et al. 2017; Choi and Yeom 2017), including skin temperature (Dai et al. 2017), heart rate (Choi and Yeom 2017), or both (Liu et al. 2019). These data collection methods are also considered intrusive because the sensor devices must contact the human skin all day. This data-gathering obstacle shows the extent to which considering contactless, non-intrusive approaches can be beneficial for obtaining personal physiological data for each occupant.

The emergence of thermal imaging techniques provides an excellent opportunity for contactless data gathering with no interruption in occupant conditions and activities. In this research, we are looking into the possibility of a non-contact vision-based method from a distance for gathering data on occupants' thermal conditions. In an attempt to create a non-invasive data gathering approach, infrared sensors were installed on eyeglasses to gather the temperature of the front face, cheeks, nose, and ears, which increased accuracy to % 82.8 for the prediction of uncomfortable conditions(Ghahramani et al. 2018). Although this device is not in direct contact with the skin, it cannot be considered a non-intrusive approach as this is still a wearable device. Infrared thermal cameras can replace these infrared sensors because they provide more non-intrusiveness through thermal imaging techniques. The infrared cameras can be installed far from the occupant and capture the skin temperature by reading the pixel values of the desired regions. By proving the feasibility of this technique with the accuracy of 94% -95 % when using FLIR A655sc (Ranjan and Scott 2016), infrared thermography has been verified as an accurate non-intrusive approach. A real-time feedback system using FlirA35 thermal camera was developed in 2018 and analyzed face temperature and occupants' position(Metzmacher et al. 2018). Researchers could replace the previously mentioned cameras with a lower-cost and smaller infrared camera with an acceptable accuracy of 85% for predicting the skin temperature compared to the expensive high-resolution cameras(Li, Menassa, and Kamat 2018). Researchers have also compared different facial feature detection algorithms to check the accuracy of each approach in detecting the regions of interest (ROIs) (Aryal and Becerik-Gerber 2019). One of the recent studies in this area has compared the accuracy of using three different sensor types, including air temperature sensors, skin temperature with a wristband, and face temperature through thermal imaging. This study highlights the slight improvement in accuracy by adding physiological sensors to the environmental sensors while questioning the efficiency of using physiological sensors due to this small accuracy increase (%3-%4)(Aryal and Becerik-Gerber 2019) In another recent study in this area, Li et al. successfully monitored and recorded two occupants' skin temperature simultaneously with two thermal camera nodes. In contrast, each camera captured some parts of the faces (Li, Menassa, and Kamat 2018)

2.0 METHODOLOGY

This section explains the primary data analysis platform setup through the dual-camera system followed by the data collection method explanation.

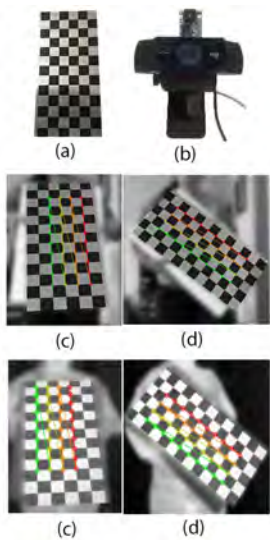

Figure 1. Camera Calibration (a) constructed checkerboard, (b) Dual Camera system, (c,d)sample detected checkerboard corners by both cameras

Infrared skin temperature is measured through our combined dual-camera system, including a FLIR Lepton 3.5 thermal infrared camera and a Logitech C922 RGB camera (Figure1). The resolution of the thermal camera is 160*120 pixels with the radiometric accuracy of $\pm 5^{\circ}\text{C}$ and a measurement resolution of 0.1 $^{\circ}\text{C}$, and the resolution of the Logitech camera is 1,280*960 pixels. Initially, a checkerboard registration approach was conducted to calibrate the cameras' intrinsic factors together, as explained by Li 2019 (Li, Menassa, and Kamat 2019a). As shown in Figure 1, a checkerboard was constructed using an aluminum sheet and vinyl polymer material with different heating values, which were heated to be detectable by the thermal camera with the checker pattern. To generate an intrinsic registration matrix between the two cameras, the checkerboard pattern must simultaneously be caught by both cameras in various angles and orientations.

After calibrating the two cameras together, thermal and RGB images captured simultaneously can read the desired facial Regions of Interest (ROI). This step is a very important and sensitive task, since wrong calibrated images will result in assigning the wrong temperature to the ROI, especially in the facial area that include adjacent areas with high temperature difference. The thermal reading method is shown in Figure 2. And explained in detail as follows:

- (a) The facial area is detected by the RGB camera and cropped in both images. After working with different face detection algorithms, we used a Dlib-based face recognition model to crop the facial area. This model is based on a 29 convolutional layer in Residual Networks ResNet (He et al. 2016).
- (b) Two masked images are created from thermal and RGB frames to precisely calibrate the two images together.

- (c) The Homography matrix is defined by using the oriented fast and rotated BRIEF (ORB) characteristics between the two masked images as previously performed by Negishi et al. (Negishi et al. 2020) for detecting the respiratory rate in medical applications.
- (d) Facial landmarks are defined from the RGB images, and desired ROIs are calculated based on them. Sixty-eight facial landmark coordinates are detected in each RGB image and are transferred to the thermal image by utilizing the developed homography matrix in the previous step.
- (e) Based on the defined ROIs, we can read either the skin temperature or the pixel intensity value based on thermal image type, 16bit radiometric images, or 8-bit non-radiometric and false-colored images accordingly.

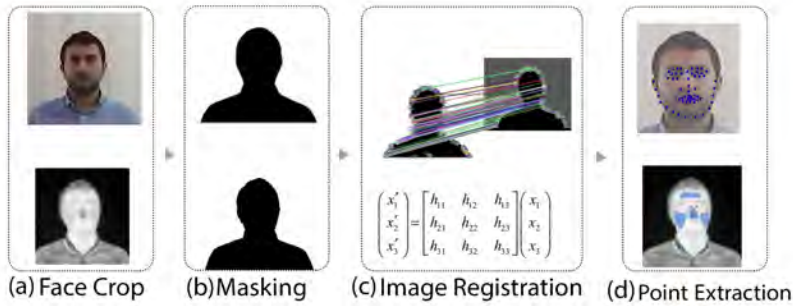

2.1. Data Collection

The experiment is designed in two separate settings to ensure a comprehensive understanding of different aspects and contributing variables in prediction accuracy. Under IRB183845, the Office of Research Protections and Integrity has provided its clearance to this study. The data collection process began in January of 2021 and continued until April of 2021. The subjects are five healthy

Figure 2. Image Registration and Thermal Reading

individuals aged 33-43 years old and all students. Before the testing, we ensured that the subjects were not suffering from any thermoregulatory disorders such as heat intolerance, colds, flu, or infections. In addition, the participants were instructed not to wear any makeup or facial moisturizer and to remove their glasses for the recording sessions. All the participants were dressed in a dark-colored long-sleeved shirt and pants.

2.1.1 Experiment 1

The preliminary experiment is designed to investigate the thermal preference prediction accuracy when utilizing two variables: 1) facial skin temperature readings by a radiometric enabled thermal camera and 2) pixel intensity data of converted non-radiometric thermal images. Personal comfort models are developed based on each individual's physiological or behavioral data through time in diverse thermal conditions for each occupant. While we do not need many subjects, each subject must be studied under several thermal conditions to provide as much data as possible for training the algorithms.

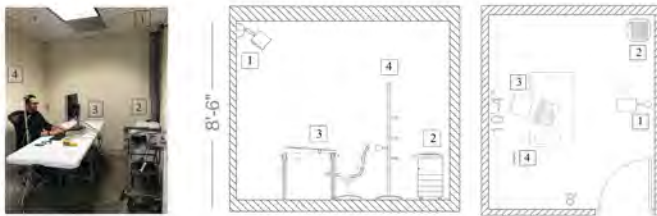

Figure 3. Study Chamber (1)Dual Camera (2)Air Conditioning (4) Data Logger (4)Environmental Sensors

This pattern was repeated three times to reach the final temperature of 28°C (~82°F). This technique generated both transient and static thermal conditions. The environmental sensors are HOBOProv2 temperature/relative humidity data logger sensors, mounted on a pole beside the subject's station at a 0.5-meter distance and at three different heights (0.1, 1.1, and 1.7 meters) to record the temperature and relative humidity.

The experiment chamber is a temperature-controlled room, as is shown in Figure 3. After taking the informed consent, the participant's age, gender, height, and weight were recorded. The participants had entered the test room and stayed in a seated position for 30 minutes before the test, so their metabolic rate reached a stable state, and any influence of the prior outdoor temperature was eliminated. The test sessions began at 22°C (71.6°F) and lasted 60 minutes, consisting of six sessions of 10 minutes static and transient conditions. The temperature was kept constant for 10 minutes and then was raised to 2°C (~5°F) higher for the next 10



Figure 4 ROI Extraction from landmarks and IButton placement

The dual-camera system is installed on the monitor in front of the user with a 1-meter (3.2ft) distance from the subject. Every five seconds, synchronized images were captured by both thermal and RGB cameras, and the skin temperature data was recorded using a thermal camera and an IButton DS1923 sensor attached to the highest point of the forehead (Figure 4). The users' subjective thermal sensation and preference were also recorded every two minutes based on their answer to the questions of "What is your current thermal sensation? (Cold, cool, slightly cool, neutral, slightly warm, warm, and hot) and "How do you prefer your thermal environment to change?" (Warmer, slightly warmer, no change, slightly cooler, colder)

2.1.2 Experiment 2

The second set of experiments are designed to investigate the prediction accuracy of non-radiometric false-color thermal images. The experiments were conducted in the same room setting, with three subjects participating individually. The main objective of this phase was to look into the correlation of different facial areas' thermal intensity with the air temperature. The

thermostat temperature was increased from 21°C (~70°F) to 28°C (~83°F) in 90 minutes with a fixed rate. The thermostat setpoint was increased by 1°C every six minutes; however, the air temperature sensors show variation, some at an increasing rate. The thermal sensors are placed as the previous session to record the temperature and relative humidity. In this session, the camera system was mounted on the wall in front of the subject with a 3 Meter (9.8ft) distance from the camera, as is shown in Figure 4. To increase the number of data points, the capturing intervals were decreased to one frame per second. The subjective thermal sensation and preference of the users are indicated as in the previous experiment, every three minutes.

3. RESULTS AND DISCUSSION

3.1. Experiment 1

The main objective of this experiment is to compare the prediction accuracy of skin temperature from higher accuracy radiometric images with the thermal intensity from 8bit false-color thermal images. As mentioned in the literature review section, recent previous research has shown that facial skin temperature extracted from radiometric images can predict the subjective thermal preference of the user through the creation of personal thermal comfort models (Li, Menassa, and Kamat 2018; 2019b; Aryal and Becerik-Gerber 2019; Cosma and Simha 2019). However, many of the currently available thermal cameras do not include the radiometric option, and therefore, the skin temperature data for each pixel would not be available. A total of 720 data frames were captured for each subject, with intervals of 5 seconds in a 60-minute experiment.

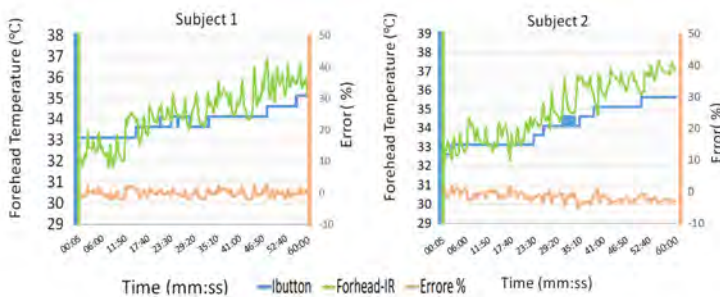

Figure 5. Forehead temperature difference between IButton & Thermal Camera

acceptable performance and accuracy for reading the skin temperature (Liu et al. 2019). The results are presented in Figure 5, which shows both temperature readings and the difference between these two readings. As the error percentage is less than 2% for both subjects, we can conclude the reliability of our skin temperature extraction method and the thermal camera's accuracy.

Furthermore, we look into the changes in room temperature, skin temperature, and lower quality images' thermal intensity in one graph for both subjects. In this regard, the initially captured 16bit and radiometric frames were converted to 8bit grayscale RGB888 images to study both sets of data frames. The extracted data first needed to be cleaned and filtered. As shown in Figure 6. although both skin temperature and pixel intensity increase as we increase the room temperature with a reliable pattern, there are some inconsistencies in the thermal camera readings. This change in thermal measurements is due to the camera's Fast Field Correction (FFC) action, which is executed every 3 minutes to recalibrate the camera. We have removed the outliers and eliminated this effect by removing the outliers and adding a moving average filter with a 5 data points period. The results of filtered data are also presented in Figure 5. The correlation between room temperature and skin temperature values and thermal intensity is calculated based on Pearson Correlation Coefficient to better understand the changing pattern in the heating transient condition.

The Pearson correlation coefficient indicates the strength and direction of a linear relationship between variables and is relevant for our calculations. As presented in Table 1., the nose area has the highest correlation with the room temperature for both subjects, which is 0.97 for subject1 and 0.96 for subject 2. The next highest correlation coefficient for both subjects

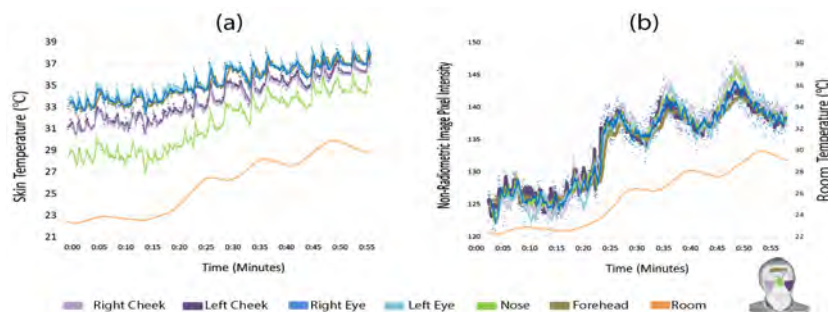

Figure 6. Raw and processed (a) skin temperature and (b) pixel intensity

are the cheeks areas, which are interestingly the same number for both sides. We need to mention that the cheeks do not show the same temperature patterns under all circumstances. This homogeneous temperature may result from running the tests in a fully controlled test chamber. The forehead and eye area have the lowest correlation with the environmental temperature, which proves the applicability of this facial area as an indicator of core body temperature, as the environmental properties have less influence on this area. This result is in line with the previous area.

Initially we looked into the accuracy of the thermal camera readings by comparing it to a more accurate wearable sensor. We have compared the IButton DS1923 sensor's temperature readings and extracted skin thermal camera in the forehead area to validate our thermal camera setting and accuracy. IButton sensors have an accuracy range of $\pm 0.5^{\circ}\text{C}$ and were previously shown to have

are the cheeks areas, which are interestingly the same number for both sides. We need to mention that the cheeks do not show the same temperature patterns under all circumstances. This homogeneous temperature may result from running the tests in a fully controlled test chamber. The forehead and eye area have the lowest correlation with the environmental temperature, which proves the applicability of this facial area as an indicator of core body temperature, as the environmental properties have less influence on this area. This result is in line with the previous area.

This result is in line with the previous findings from (Silawan et al. 2018) on the correlation of different facial regions with the environmental temperature. The same table also presents the calculated correlation from the second set of image frames with false color and lower quality 8bit format. The correlation numbers with the room temperature in the lower quality images' pixel intensity are lower. They do not follow the same pattern of skin temperature, which might be expected. However, the nose area still has the highest correlation with the room temperature among other facial regions.

		Nose	Forehead	Right Cheek	Left Cheek	Right Eye	Left Eye
S1	Skin Temperature	0.97	0.94	0.95	0.95	0.92	0.91
	Pixel Intensity	0.90	0.91	0.83	0.85	0.89	0.82
S2	Skin Temperature	0.96	0.92	0.94	0.94	0.89	0.91
	Pixel Intensity	0.89	0.88	0.83	0.89	0.87	0.76

Table 1. Correlation of different facial regions with the room temperature in both image types

Furthermore, the thermal preference prediction accuracy of three machine learning algorithms is calculated and compared. For each participant, 30 subjective thermal sensation and thermal preference data were recorded. As previously studied by researchers, thermal preference is a better indicator of thermal comfort, so in this paper, we are not working with subjective thermal preference data. The responses were divided into three categories, with "Slightly Warmer" and "Warmer" assigned to a "Warmer" category and "Slightly Cooler" and "Colder" assigned to a "Cooler" category. Since 720 thermal frames and 30 subjective votes were recorded, each subjective vote was assigned to the thermal frames between two voting sessions (Every 2 Minutes). To assess the efficacy of machine learning algorithms for predicting thermal comfort, we trained three previously shown successful algorithms in predicting personalized thermal comfort from the literature. Random Forest, Support Vector Machine (SVM), and K-Nearest Neighbor (KNN) were trained and tested with each subject's personalized physiological and subjective data. Table2 shows the average accuracy of these three algorithms for all three subjects. In addition, the precision for each class category is presented. The Random Forest produces the highest prediction results for both subjects in both radiometric and non-radiometric images, which are (0.93, 0.79) for subject1 and (0.90, 0.81) for subject 2. The SVM algorithm had predicted better than KNN (n=6) for the first subject but worse for the second one. Therefore we cannot conclude which algorithm would be a better choice from these two. We can also see that all algorithms have better performance for both subjects when working with radiometric images and skin temperature. However, the performance of pixel intensity is still acceptable, primarily when it was used to train the Random Forest algorithm (0.79 and 0.81). For the next experiment, we will study the performance of these three algorithms with lower quality non-radiometric images from a larger distance.

ID		Random Forest				KNN				SVM			
		Accuracy	Precision			Accuracy	Precision			Accuracy	Precision		
			Cooler	No Change	Warmer		Cooler	No Change	Warmer		Cooler	No Change	Warmer
S1	Skin Temp.	0.93	0.89	0.89	1.00	0.87	0.81	0.84	1.0	0.82	0.86	0.70	0.90
	Intensity	0.79	0.97	0.62	0.71	0.73	0.93	0.57	0.70	0.60	0.96	0.56	0.00
S2	Skin Temp.	0.90	0.87	0.85	1.00	0.78	0.77	0.68	0.89	0.86	0.88	0.78	0.95
	Intensity	0.81	0.85	0.68	0.89	0.78	0.80	0.64	0.89	0.78	0.68	1.0	0.67

Table 2. Prediction accuracy of three selected prediction algorithms in both image types

3.1. Experiment 2

In the second set of experiments, we have recorded the frames without the radiometric option to have a detailed look at the prediction accuracy of lower quality and false-colored 8bit thermal images from a 3-meter distance. We increased the number of data frames to compensate for the accuracy decrease due to this conversion and increased camera distance. The data reading interval was decreased to 1 second, which has provided us with approximately 5000 data points for each subject. The intervals of recording the thermal preference were increased to three minutes due to the previous subjects' feedback. For each participant, 30 subjective thermal votes were recorded. In addition, we have changed the thermal preference categorizing patterns to 4 levels and divided the "cooler" preference into two categories of "slightly cooler" and "colder." The lowest starting temperature was around 21°C (70°F) to ensure the subjects were not exposed to extreme cold conditions for health considerations; the cold temperature duration is less than the hot segment and does not need to be divided into categories. Since the distance to the camera has increased and we are using lower quality images, we have excluded the eye area from the calculations to avoid accuracy due to the low number of pixels in those areas.

Figure.7 presents the change in the room temperature and pixel intensity of the selected areas with a polynomial regression of 6th degrees applied to them, along with the subjective thermal vote of the participants. As shown in Figure.7, the subjective thermal preference of the participants starts with "slightly warmer" as they were subjected to an approximate temperature of 21°C (70°F) for 20 minutes before the start of data recording. The figure shows that all three subjects have experienced the four thermal preferences, while "No Change" is the majority of votes for all. It is also demonstrated that the changing pattern in the skin temperature is different for each subject. The facial areas in subject 3 have a closer temperature together. On the other hand, subject 5 has a similar temperature in the cheeks area, while the forehead and nose area's temperature is more similar and different from the cheeks. Another interesting point about cheeks' temperature in subject5 is their considerable correlation with the subject's thermal preference. The subject's thermal preference was "No change" at the beginning of the experiment, but after 10 minutes, as the cheeks temperature decreases due to the cold weather, the subject would prefer a slightly warmer environment.

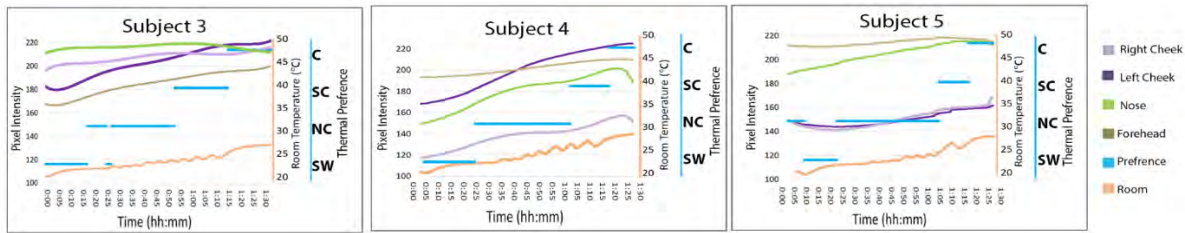

Figure 7. Changes in room temperature, pixel intensity, and thermal preference (C: colder, SC: slightly colder, NC: no change, SW: slightly warmer)

Table 2. shows the Average Accuracy for all three subjects by the selected algorithms. In addition, the precision for each class category is presented. The SVM algorithm shows the lowest prediction results for all three subjects, similar to the previous results (0.82, 0.85, 0.86). On the other hand, the Random forest and KNN algorithms show approximately close results in both the Average Accuracy and Precision in the prediction of each class. The precision results for both of these algorithm are better in predicting cold preference than warmer preference. However, the SVM algorithm had performed better in the warm preference class.

ID	Random Forest					KNN					SVM				
	Accuracy	Precision				Accuracy	Precision				Accuracy	Precision			
	Colder	Slightly Colder	No Change	Warmer	Colder		Slightly Cooler	No Change	Warmer	Colder		Slightly Cooler	No Change	Warmer	
S3	0.95	0.98	0.92	0.95	0.96	0.95	0.98	0.92	0.95	0.94	0.85	0.94	0.73	0.81	0.92
S4	0.95	0.97	0.89	0.98	0.97	0.96	0.96	0.93	0.98	0.97	0.82	0.83	0.61	0.90	0.92
S5	0.9	0.99	1.00	0.98	0.94	0.95	0.99	0.99	0.98	0.86	0.86	0.92	0.61	0.67	1.00

Table 3. Prediction accuracy of three selected prediction algorithms for all three subjects

The confusion matrices for all three subjects are presented in Figure.8 to comprehensively analyze the three algorithms' performance in predicting different thermal preference classes. This figure shows that the SVM classifier has the lowest number of True predictions and the highest amounts of False ones in all class categories. The performance of this algorithm is deficient, especially in predicting warmer preferences. In addition, the number of false predictions is much higher than the other two algorithms in several classes. The performance of Random Forest and KNN algorithms are primarily close together, with some slight differences. The only notable difference is predicting colder preference in Subject 4, 0.89% for Random Forest and 96% for the KNN algorithm.

CONCLUSION

An automated infrared thermal reading platform was studied to predict the personalized thermal preference in heating transient conditions. The highlight of this approach is the automatic calibration of thermal and RGB images without manual registration or knowing the subjects' distance from the camera.

The tests were conducted in two sessions to compare the feasibility of utilizing non-radiometric images instead of higher-quality radiometric images. It was found that although the prediction performance of radiometric enabled images was superior to non-radiometric ones, by increasing the number of data frames, we can obtain very high accuracy predictions from lower quality images. Another finding of this study is the better performance of Random Forest and KNN to SVM prediction algorithm, which is also in line with the prior research in this area. Therefore we do not recommend utilizing SVM algorithms for personalized thermal comfort prediction.

This study also has some limitations that need to be addressed in our current and future tests on personalized thermal comfort prediction. Although the number of subjects does not need to be many in a personalized prediction algorithm, we still need to perform this research with more subjects to study the prediction performance in more diverse physiological properties. In this set of experiments, we had not recorded the air velocity.

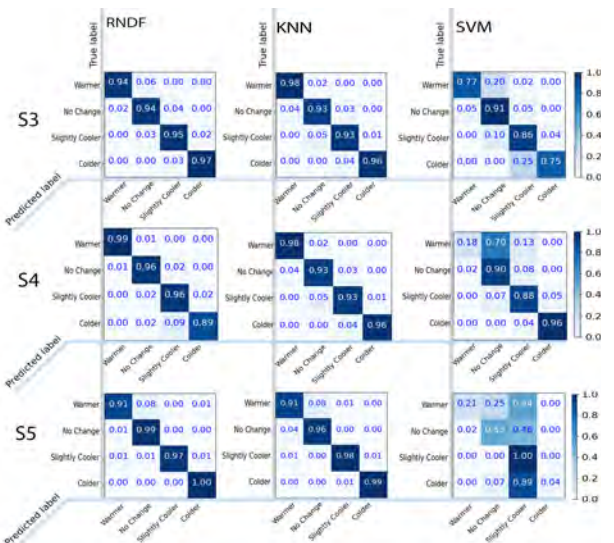

Figure 8. Confusion matrices for three prediction algorithms

We will also add air velocity to the calculations and study its influence on thermal sensation and preference for the next experiments. Furthermore, the subject's distance to the camera was not changing at the time of the experiment. Also, the subject's head positions were mainly the same during the experiment: full frontal face with minor amounts of yaw or pitching

at times. Research has shown that the distance to the camera and angle with the thermal sensor influences the infrared thermal readings. It is important to perform the experiment at several other distances from the camera and at different head positions. We are currently conducting another set of experiments, which will be presented in our future publications. Finally, although research in test chambers and transient conditions is an excellent approach for gathering large amounts of data in less time, it may not be as realistic as the data collected through time in a natural office setting. We are also working on performing these tests in an actual office building set for our future research.

ACKNOWLEDGEMENTS

This publication resulted from research supported by The School of Data Science at UNC Charlotte (Data Science Initiative award), and National Science Foundation (Award number NSF2104223).

REFERENCES

- Administration, U.S. Energy Information, and Office of Integrated and International Energy Analysis. 2014. "Annual Energy Outlook 2014." www.eia.gov/analysis/model-documentation.cfm.
- Amirazar, A., M. Azarbayjani, O.-K. Im, A.H. Zarrabi, R. Ashrafi, R. Cox, and A. Johnson. 2018. "Assessing the Circadian Potential of an Office Building in the Southeastern US." In *Simulation Series*. Vol. 50.
- Amirazar, Armin, Mona Azarbayjani, Ben Futrell, Amir Hosseinzadeh Zarrabi, and Roshanak Ashrafi. 2018. "Visual Comfort Assessment of Different Shading Strategies in a Commercial Office Building in the Southeastern US," 27–32. <https://doi.org/10.14305/IBPC.2018.HF-4.06>.
- Aryal, Ashrant, and Burcin Becerik-Gerber. 2019. "A Comparative Study of Predicting Individual Thermal Sensation and Satisfaction Using Wrist-Worn Temperature Sensor, Thermal Camera and Ambient Temperature Sensor." *Building and Environment* 160 (August). <https://doi.org/10.1016/j.buildenv.2019.106223>.
- Ashrafi, Roshanak, Mona Azarbayjani, Robert Cox, Benjamin Futrell, Joseph Glass, Amir Zarrabi, and Armin Amirazar. 2019. "Assessing the Performance of UFAD System in an Office Building Located in Various Climate Zones." In *Proceedings of the Symposium on Simulation for Architecture and Urban Design*. SIMAUD '19. San Diego, CA, USA: Society for Computer Simulation International.
- Cheng, Yuanda, Jianlei Niu, and Naiping Gao. 2012. "Thermal Comfort Models: A Review and Numerical Investigation." *Building and Environment* 47 (1): 13–22. <https://doi.org/10.1016/j.buildenv.2011.05.011>.
- Cheung, Toby, Stefano Schiavon, Thomas Parkinson, Peixian Li, and Gail Brager. 2019. "Analysis of the Accuracy on PMV – PPD Model Using the ASHRAE Global Thermal Comfort Database II." *Building and Environment* 153 (April): 205–17. <https://doi.org/10.1016/j.buildenv.2019.01.055>.
- Choi, Joon-Ho, and Dongwoo Yeom. 2017. "Study of Data-Driven Thermal Sensation Prediction Model as a Function of Local Body Skin Temperatures in a Built Environment." *Building and Environment* 121 (August): 130–47. <https://doi.org/10.1016/j.buildenv.2017.05.004>.
- Cosma, Andrei Claudiu, and Rahul Simha. 2019. "Machine Learning Method for Real-Time Non-Invasive Prediction of Individual Thermal Preference in Transient Conditions." *Building and Environment* 148 (July 2018): 372–83. <https://doi.org/10.1016/j.buildenv.2018.11.017>.
- Dai, Changzhi, Hui Zhang, Edward Arens, and Zhiwei Lian. 2017. "Machine Learning Approaches to Predict Thermal Demands Using Skin Temperatures: Steady-State Conditions." *Building and Environment* 114 (March): 1–10. <https://doi.org/10.1016/j.buildenv.2016.12.005>.
- Erickson, Varick L, and Alberto E Cerpa. n.d. *Thermovote: Participatory Sensing for Efficient Building HVAC Conditioning*. Accessed June 13, 2019..
- Ghaffarianhoseini, Amirhosein, Husam Alwaer, Hossein Omrany, Ali Ghaffarianhoseini, Chaham Alalouch, Derek Clements-Croome, and John Tookey. 2018. "Architectural Science Review Sick Building Syndrome: Are We Doing Enough? Sick Building Syndrome: Are We Doing Enough?" *ARCHITECTURAL SCIENCE REVIEW* 61 (3): 99–121. <https://doi.org/10.1080/00038628.2018.1461060>.
- Ghahramani, Ali, Guillermo Castro, Simin Ahmadi Karvigh, and Burcin Becerik-Gerber. 2018. "Towards Unsupervised Learning of Thermal Comfort Using Infrared Thermography." *Applied Energy* 211 (February): 41–49. <https://doi.org/10.1016/j.apenergy.2017.11.021>.
- He, Kaiming, Xiangyu Zhang, Shaoqing Ren, and Jian Sun. 2016. "Deep Residual Learning for Image Recognition." *Proceedings of the IEEE Computer Society Conference on Computer Vision and Pattern Recognition* 2016-December: 770–78. <https://doi.org/10.1109/CVPR.2016.90>.
- Humphreys, Michael A., and J. Fergus Nicol. 2002. "The Validity of ISO-PMV for Predicting Comfort Votes in Every-Day Thermal Environments." *Energy and Buildings* 34 (6): 667–84. [https://doi.org/10.1016/S0378-7788\(02\)00018-X](https://doi.org/10.1016/S0378-7788(02)00018-X).
- Jazizadeh, Farrokh, Franco Moiso Marin, and Burcin Becerik-Gerber. 2013. "A Thermal Preference Scale for Personalized Comfort Profile Identification via Participatory Sensing." *Building and Environment* 68 (October): 140–49. <https://doi.org/10.1016/j.buildenv.2013.06.011>.
- Jung, Wooyoung, and Farrokh Jazizadeh. 2018. "Vision-Based Thermal Comfort Quantification for HVAC Control." *Building and Environment* 142 (September): 513–23. <https://doi.org/10.1016/j.buildenv.2018.05.018>.
- Li, Da, Carol C. Menassa, and Vineet R. Kamat. 2018. "Non-Intrusive Interpretation of Human Thermal Comfort through Analysis of Facial Infrared Thermography." *Energy and Buildings* 176 (October): 246–61. <https://doi.org/10.1016/j.enbuild.2018.07.025>.
- Liu, Shichao, Stefano Schiavon, Hari Prasanna Das, Ming Jin, and Costas J. Spanos. 2019. "Personal Thermal Comfort Models with Wearable Sensors." *Building and Environment* 162 (September): 106281. <https://doi.org/10.1016/j.buildenv.2019.106281>.
- Mendell, Mark J, William J Fisk, Kathleen Kreiss, Hal Levin, Darryl Alexander, William S Cain, John R Girman, et al. 2002. "1430 | Public Health Matters | Peer Reviewed | Mendell et Al." *American Journal of Public Health*. Vol. 92.
- Metzmacher, Henning, Daniel Wölki, Carolin Schmidt, Jérôme Frisch, and Christoph van Treeck. 2018. "Real-Time Human Skin Temperature Analysis Using Thermal Image Recognition for Thermal Comfort Assessment." *Energy and Buildings* 158 (January): 1063–78.
- Mostafavi, Saman, Robert Cox, Benjamin Futrell, and Roshanak Ashafari. 2018. "Calibration of White-Box Whole-Building Energy Models Using a Systems-Identification Approach." *Proceedings: IECON 2018 - 44th Annual Conference of the IEEE Industrial Electronics Society*, December, 795–800. <https://doi.org/10.1109/IECON.2018.8591845>.
- Negishi, Toshiaki, Shigeto Abe, Takemi Matsui, He Liu, Masaki Kurosawa, Tetsuo Kirimoto, and Guanghao Sun. 2020. "Contactless Vital Signs Measurement System Using RGB-Thermal Image Sensors and Its Clinical Screening Test on Patients with Seasonal Influenza." *Sensors (Switzerland)* 20 (8). <https://doi.org/10.3390/s20082171>.
- Ranjan, Juhi, and James Scott. 2016. "ThermalSense: Determining Dynamic Thermal Comfort Preferences Using Thermographic Imaging." <https://doi.org/10.1145/2971648.2971659>.
- Ray, P. P. 2018. "A Survey on Internet of Things Architectures." *Journal of King Saud University - Computer and Information Sciences*. King Saud bin Abdulaziz University. <https://doi.org/10.1016/j.jksuci.2016.10.003>.
- Ruoxi Jia, By, Baihong Jin, Ming Jin, Yuxun Zhou, Ioannis C Konstantakopoulos, Han Zou, Joyce Kim, et al. 2018. "Design Automation for Smart Building Systems." <https://doi.org/10.1109/JPROC.2018.2856932>.
- Rupp, Ricardo Forgiarini, Natalia Giraldo Vásquez, and Roberto Lamberts. 2015. "A Review of Human Thermal Comfort in the Built Environment." *Energy and Buildings* 105: 178–205. <https://doi.org/10.1016/j.enbuild.2015.07.047>.
- Shahzad, Sally, John Kaiser Calautit, Angelo I. Aquino, Diana SNM Nasir, and Ben Richard Hughes. 2017. "Neutral Thermal Sensation or Dynamic Thermal Comfort? Numerical and Field Test Analysis of a Thermal Chair." *Energy Procedia* 142 (December): 2189–94.
- Silawan, Nawatt, Koichi Kusukame, Khai Jun Kek, and Win Sen Kuan. 2018. "A Novel Environment-Invariant Core Body Temperature Estimation for High Sensitivity and Specificity Fever Screening." *Proceedings of the Annual International Conference of the IEEE Engineering in Medicine and Biology Society, EMBS 2018-July*: 1612–15. <https://doi.org/10.1109/EMBC.2018.8512541>.
- "WHO | Social Determinants of Health." 2015. *WHO*.
- Zarrabi, Amir Hosseinzadeh, Mona Azarbayjani, Armin Amirazar, and Roshanak Asharafi. 2018. "Comparative Study of Different Design Configurations Based on the Daylight and Visual Comfort Performance of Electrochromic Glass in a Side-Lit Office Building," 811–16. <https://doi.org/10.14305/IBPC.2018.IE-3.02>.

Urban Heat Island Phenomena in Dhaka, Bangladesh

Tasneem Tariq¹, Ute Poerschke¹, Lisa Domenica Iulo¹

¹Pennsylvania State University, State College, PA

ABSTRACT: With rapid urbanization, Dhaka, the capital of Bangladesh, is progressively falling short of sustaining outdoor life due to the Urban Heat Island (UHI) effects, which is one of the most documented phenomena of urban climate change. The UHI intensity inside and around Dhaka varies from 2.5°C to 7.5°C, which leads to additional demand on the urban energy resources for cooling. It is reported that 75% power consumption of the city is occurring to achieve comfortable thermal conditions. While currently, 34.3% of Bangladesh's population lives in urban areas, it is projected to increase to 56% by 2050, which will eventually worsen the UHI phenomenon. Dhaka possesses only 0.12 acres of greenery and open areas per one thousand people, while according to a recommendation from the National Recreation and Park Association between 6.25 and 10.5 acres of total open space per thousand is needed. Since the consequences of UHI are significant, the severity of the problem should be carefully examined and reported. Therefore, this study emphasizes a critical investigation of the features and factors of UHI affecting the outdoor thermal comfort of Dhaka city. Published scientific papers, governmental reports, and other national publications have been explored to conduct a systematic review to identify the major contributing factors of the UHI in the context of Dhaka. This paper identifies that rapid population migration to Dhaka, reduction of percentages of vegetation and green spaces in the land cover, and the unplanned dense urban development by altering the natural surfaces to impervious surfaces are some of the major contributing factors to the formation of the UHI phenomenon in Dhaka.

KEYWORDS: UHI effects, Dhaka, factors, mitigation

1.0 INTRODUCTION

Favorable microclimate in cities has a significant impact on the urban life of the people (Nikolopoulou and Steemers 2003) (Gaitani, Mihalakakou, and Santamouris 2007). Outdoor spaces in a city which are thermally comfortable have an increasing social and economic benefit as they attract more local residents, vendors, office workers, students etc. and increase the social interaction (Nikolopoulou, Baker, and Steemers 2001). Thermally comfortable outdoor spaces in different parts of the city often turn into public gathering places thereby fostering a high-quality urban life. Rapid urban population growth due to the high flow of migrated population towards the cities is one of the main reasons for unplanned urban expansion in developing countries (Sidiqui et al. 2014). Cities, which are covered with large heat-holding capacity surfaces and structures, such as, concrete and asphalt, stay warmer and release more heat than suburbs and surrounding country. According to Intergovernmental Panel on Climate Change (IPCC 2007), global surface temperature has increased 0.74 ± 0.18 degree Celsius during the period from 1905 to 2005. This phenomenon is also observed strongly in Dhaka city, the capital of Bangladesh. Studies found that, in the last 100 years, the average temperature in Dhaka has increased by 0.5 degree Celsius, and in the next 50 years it is expected to increase by another 1.5–2 degrees (Draft Dhaka Structure Plan 2015). Unfortunately, due to rapid urbanization trend, the outdoor urban public spaces in Dhaka are declining every day and the outdoor thermal comfort in Dhaka City is an under addressed issue. This is of concern because outdoor spaces have always played a very important role in tropical countries like Bangladesh (Ahmed 2003). Traditionally, several social and economic activities, like crops processing, cooking, eating, sewing, gossiping and even schooling, have taken place in the outdoor spaces in Bangladesh. There are many reasons to revive urban spaces and secure their future considering the socio-cultural domain of Bangladesh. A comfortable outdoor microclimate even seems to be a prerequisite for Dhaka city to ensure social integration. Ensuring an acceptable urban microclimate is vital for architects, urban designers, planners and policy makers (Ahmed 2003). A thermally comfortable outdoor environment can also have a positive impact on indoor conditions, which will lead to lower energy demand for space conditioning (Johansson and Emmanuel 2006). Therefore, creating a thermally comfortable outdoor microclimate in an urban environment by mitigating the UHI effects is of utmost importance.

2.0 RESEARCH METHODOLOGY AND RESEARCH QUESTIONS

This study emphasizes a critical investigation of the features and factors of UHI affecting the outdoor thermal comfort of Dhaka city, Bangladesh as it is tremendously affected by the global phenomena of Urban Heat Island effects. There is a lack of knowledge regarding the UHI effects and spatiotemporal variation of day and night surface urban heat island intensity (SUHI) in the major cities of Bangladesh. However, very limited scientific data and analysis are found on this topic. In this paper, firstly, the climate and urbanization in Dhaka Bangladesh has been analyzed through literature review. Then the current trend of UHI effects in Dhaka and other major cities in Bangladesh have been analyzed. Finally, to identify the major contributing factors of the UHI in the context of Dhaka, a systematic review has been done,

in which several published scientific papers, governmental reports, and other national publications have been explored. The major research questions for this paper are:

1. What are the current conditions of UHI effects in Dhaka, Bangladesh?
2. What are the major contributing factors of the UHI effects in the context of Dhaka?

3.0 CLIMATE AND THERMAL COMFORT IN DHAKA, BANGLADESH

Bangladesh, one of the fastest-growing developing countries in South Asia, is bordered by India, Myanmar and the Bay of Bengal (Figure 1). Bangladesh lies in the tropics, more precisely between latitude 20°34' and 26°33' North and between longitude 88°01' to 92°41' East, in the Indo-Malayan realm, as described by UNESCO (Lean 1990). Bangladesh has a small area of land (147,570km²) but a large number of people (169 million), making it the eighth-most populous country on earth, with one of the highest population densities (1142.29/km²) (UN, 2015). Due to rapid urbanisation at an annual rate of 2.4 percent (UN 2015), by 2050, nearly 56% of the country's total population will be living in urban areas, compared with 34.3 percent in 2015 (UN 2015). Bangladesh is frequently cited as one of the most vulnerable countries to climate change (Huq 2001), because of its disadvantageous geographic location, high population density, reliance of many livelihoods on climate sensitive sectors etc. The most anticipated adverse effects of climate change are sea level rise, higher temperatures, and an increase in cyclone intensity, which will eventually impede the development in Bangladesh. According to Atkinson's classification of tropical climates, Bangladesh is a tropical country on the edge of the Tropic of Cancer, having a composite monsoon climate, with a rather long warm humid season (Ahmed 1994). Figure 2 shows seven climatic sub zones of Bangladesh, with Dhaka being situated in the south-central (G) zone of Bangladesh. Generally, the climate has short and dry winters while the summer is long and wet. Meteorologically the climate of Bangladesh can be categorized into four distinct seasons.



Figure 1: Location of Dhaka and Bangladesh in the world map. Source: (World Atlas Travel 1994)



Figure 2: The climatic sub zones of Bangladesh. Source: (Rashid 1991)

A study shows that, in tropical climates like Dhaka under still air conditions for people wearing typical summer clothes (0.4 to 0.5 Clo) and being involved in sedentary activities, the comfortable temperature ranges from 28.5°C to 32°C at an average relative humidity of 70% (Mallick 1994). The comfort range provides an indication of tolerance to higher temperature and relative humidity than the international standards. Therefore, thermal comfort scales developed in the colder regions of the western world is not completely applicable for Dhaka (Mallick 1994). Figure 3 shows the comfort conditions of people living in residential housing in Dhaka, identified based on the analysis of air temperature, radiant temperature, air velocity and relative humidity values by Mallick (Mallick 1994) using the Bedford scale (Bedford 1936) and ASHRAE scale, which depicts comfort in higher temperatures than the international standards.

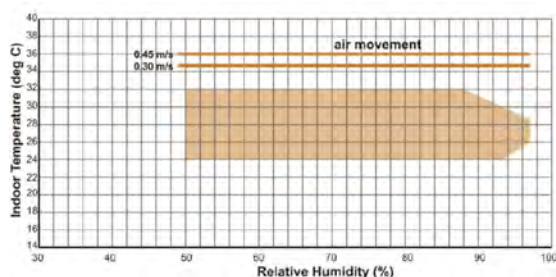

Figure 3: Summer comfort zone for urban housing of Dhaka, Bangladesh. Source: (Mallick 1994)

4.0 URBANIZATION, CLIMATE CHANGE AND URBAN HEAT ISLAND IN DHAKA, BANGLADESH

Elevated air temperature is observed in high density urban areas as compared to the nearby area (Caprio et al. 1997). The temperature of an urban area can be even 11°C higher than the surrounding countryside (ASHRAE 1974). According to the Long-Term Climate Risk Index (CRI) 2021, Bangladesh is the 7th most affected country (Figure 4) from 2000 to 2019 (Eckstein et al. 2021), though its contribution to the climate change is insignificant. In naturally

ventilated buildings, which is very common in Dhaka city, a comfortable outdoor urban environment can play an extremely favorable role in creating comfortable indoor environments (Mallick 1994). In the outdoor spaces of Dhaka, a preference for shaded spaces and exposure to air flow have been observed (Mohamed and Srinavin 2002).

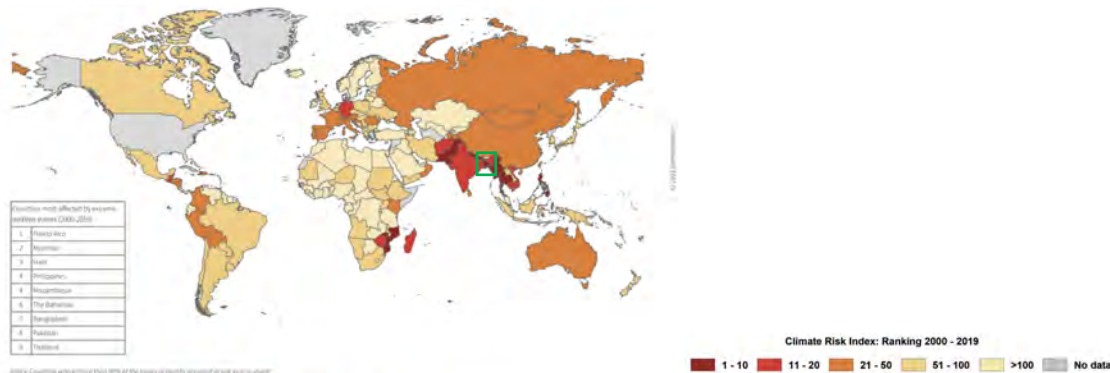

Figure 4: World Map of the Global Climate Risk Index 2000-2019, where Bangladesh (marked) is among 1-10. Source: (Climate Risk Index 2021)

Dhaka is experiencing a very high expansion and urbanization growth rate, far greater than the other cities of Bangladesh (BBS 2013; Corner and Dewan 2013), as it attracts over 300,000 to 400,000 new migrants each year (BBS 2013). UHI effect is a common phenomenon in tropical cities like Dhaka because of the rapid migration to cities and the increasing number of buildings. Though people in these regions tend to tolerate both higher temperatures with higher levels of relative humidity (Mallick 1994), the UHI effects have a considerable effect on the occupant’s thermal comfort perception and performance and well-being. According to the World Bank (2000), the risk associated to human health in tropical developing countries is one of the salient risks of climate change. Therefore, it is vital to observe the climate and UHI effects in Dhaka City.

Intergovernmental Panel on Climate Change (IPCC) has reported in their fourth assessment report that global surface temperature increased $0.74 \pm 0.18 \text{ }^\circ\text{C}$ during the 100 years ending in 2005 and noted that the rise of mean annual temperature is predicted to be $3.3 \text{ }^\circ\text{C}$ per century (IPCC 2007). Again, in the sixth assessment report IPCC has reported that the average global temperatures will continue to rise and could increase by 5.7°C by the end of this century as compared to 1850-1900 (IPCC 2021), which is a much higher value than the previous prediction. Consequently, the land surface will continue to warm more than the ocean surface. The Arctic will continue to warm more than global surface temperature. Every additional 0.5°C rise in temperature amplifies the intensity and frequency of heatwaves, heavy precipitation, and droughts. Several studies have been carried out on the trend of climate change in climatic parameters over Bangladesh. Chowdhury and Debsharma (1992) and Mia (2003) pointed out that temperature has risen by using historical data of some selected meteorological station (Figure 5). Parathasarathy, et al. (1987) and Divya and Mehritra (1995) reported mean annual temperature of Bangladesh has increased during the period of 1895-1980 by 0.31°C over the past two decades. Karmakar and Shrestha (2000) using the 1961-1990 data for Bangladesh projected an annual mean maximum temperature rise of $0.4 \text{ }^\circ\text{C}$ and $0.73 \text{ }^\circ\text{C}$, by the year of 2050 and 2100 respectively. Nigar et al, (2017) have showed that the ground-based data obtained from Agargaon meteorological monitoring station in Dhaka indicate the rising trend of average yearly temperature in Dhaka City (Figure 6).

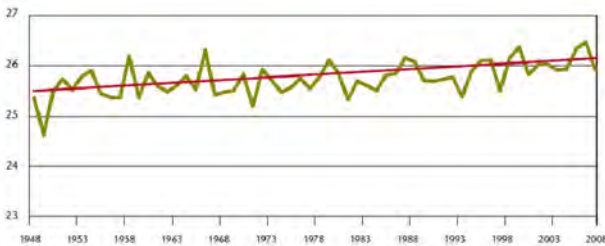

Figure 5: Trend in surface air temperatures for Bangladesh. Source: (Bangladesh Met Department, 2010)

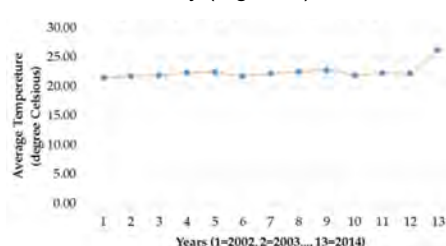

Figure 6: Average yearly temperature of Dhaka City. Source: (Nigar et al, 2017)

Studies of Mridha (2002) and Hossain and Nooruddin (1993) have showed the difference between the temperature of Dhaka City and the rural area were around $0.4\text{-}0.5 \text{ }^\circ\text{C}$ during 1961-1990, which is much higher in recent times. Thus, the UHI effect is getting worse in Dhaka with time (Mridha 2002, Hossain and Nooruddin 1993). The rising temperatures is currently a growing environmental concern for Dhaka. Figure 7 shows the temperature trends during the last 60 years (1950-2010), based on observed data of BMD (2011), where both the maximum and minimum temperatures follow upward trends, making the average day temperature rising.

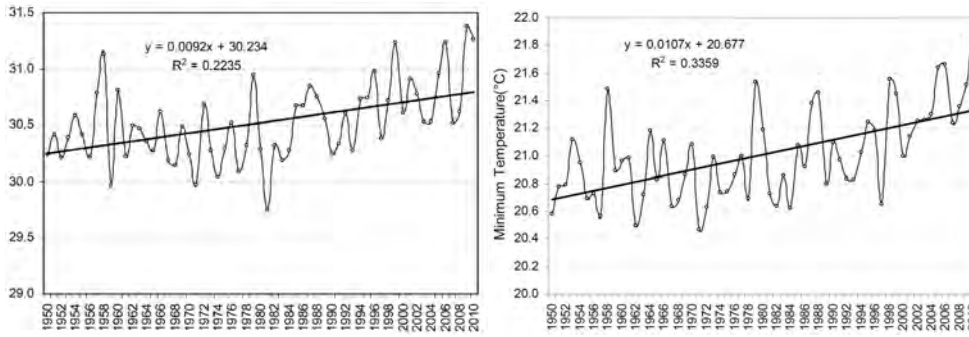

Figure 7: Temporal variation of annual maximum temperature (Left) and Minimum (Right) of Bangladesh during 1950-2010. Source: (Bangladesh Meteorological Department, 2011)

Figure 8 shows the monthly mean maximum and minimum temperature profile, for four-time spans; 1950-1980, 1981-1990, 1991-2000, and 2001-2011. It is evident that the annual average temperature of Dhaka is increasing with time, which is consistent with the regional data of Bangladesh. According to the investigation done by Hossain and Nooruddin (1993), the relative humidity in adjacent rural areas of Dhaka city is higher and it generally decreases towards city center (Mridha 2002). In addition to this, relative humidity has been found to be inversely related with the prevailing temperature, thus increase of temperature reduces the level relative humidity in a given situation, if all other conditions remain same (Mridha 2002). Figure 9 shows a decreasing trend in relative humidity in Dhaka city than the previous decades, which is again an environmental concern. The projected magnitudes of these impacts appear to be substantial in the case of Bangladesh and have the potential to threaten the very existence of a large percentage of population, either by causing death and damage or by affecting livelihoods (Huq 2001).

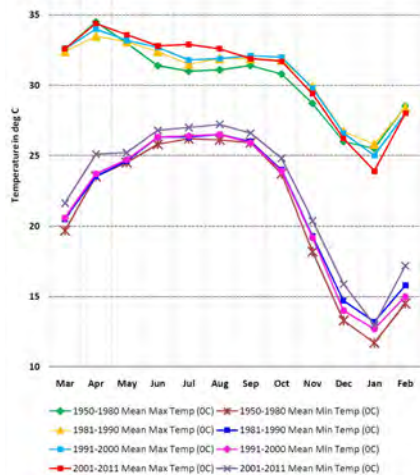

Figure 8: Monthly Mean Maximum and Minimum Air temperature profile for the year 1950-1980, 1981-1990, 1991-2000, and 2001-2011. Source: (Bangladesh Meteorological Department, Dhaka, 2012)

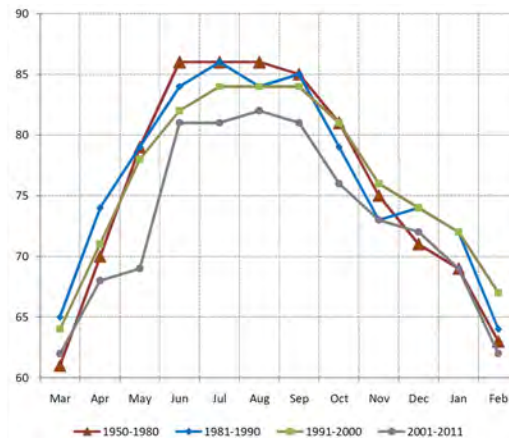

Figure 9: Monthly Relative Humidity and annual variation during 1950-2011. Source: (Bangladesh Meteorological Department, Dhaka, 2012)

5.0 FACTORS CAUSING THE URBAN HEAT ISLAND EFFECTS IN BANGLADESH

The world's total urban area has expanded by 168% between 2001 and 2018, with the highest growth rates in Asia and Africa (Huang, Huang, Wen, & Li, 2021). Cities and their inhabitants have become key drivers of global environmental change (Grimmond, 2007) due to a significant increase in human-created impervious areas around the globe (Gong et al., 2020). Urban expansion substantially alters natural surfaces, resulting in a range of environmental effects (Girardet, 2020). The difference in temperature between the urban and surrounding rural areas is possibly the most visible effect associated with the urbanisation process and is mainly due to increased human activities (Heisler & Brazel, 2010). Similar results have been found in the context of Bangladesh (Eckstein, Künzel, Sch' afer, & Wings, 2019). Kotharkar, Ramesh, and Bagade (2018), in a critical review of existing research, demonstrated that baseline data about UHIs of Bangladesh cities is clearly lacking. However, recently the urban warming has been recognised as an important issue affecting these large urban areas. Due to an ever-increasing population, Bangladesh has experienced a substantial reduction of existing natural surface (such as forest and agricultural lands), and an associated expansion in urban land (Rai, Zhang, Paudel, Li, & Khanal, 2017). The urban population of the country grew from 22.5M in 1990 to 60M in 2019 (World Bank 2000; BBS, 2012), with resultant environmental issues in the major cities, including a sharp increase in

observed temperatures (Kant, Azim, & Mitra, 2018). The trend of increasingly elevated temperatures in Dhaka city is projected to increase, and continuous hot spell periods may become more common (Mourshed, 2011).

There are two major types of UHI effects: a) the atmospheric urban heat island (AUHI), and b) the surface urban heat island (SUHI). The type of UHI is based on the height above the ground at which the phenomenon is observed and measured (Oke, 1982). To produce the baseline information about urban heat island intensity (SUHII) in the major cities of Bangladesh, drivers and temporal trends in five major cities, time series diurnal (day/night) MODIS land surface temperature (LST) data for the period 2000–2019 was used (Dewan et al 2021). Results indicated that annual average daytime SUHII is greatest in Dhaka, (2.74°C), followed by Chittagong (1.92°C), Khulna (1.27°C), Sylhet (1.10°C) and Rajshahi (0.74°C) (Figure 10). SUHII observed during the day was also greater than at night.

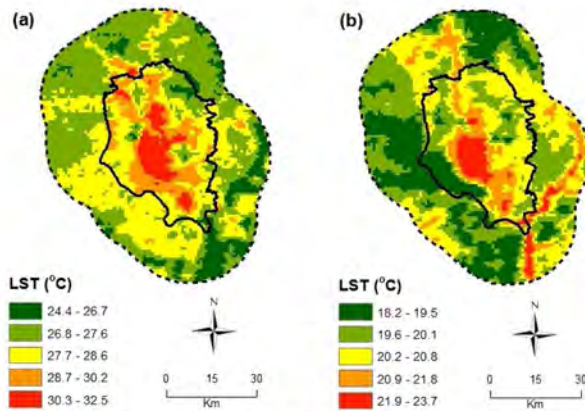

Figure 10: Average land surface temperature (LST) of 2019 in Dhaka Megacity and difference of urban and rural boundaries; a. Day, b. Night. Black solid polygon is Dhaka Metropolitan Development Plan (DMDP) boundary and dashed line is the rural location. Source: (Dewan et al. 2021)

According to Dewan et al (2021), the SUHII is mainly concentrated in the urban core, both during the day and at night (Figure 11). The main urban core of Dhaka experiences values as high as 5°C, the SUHII values for the next largest city, Chittagong, ranges from 2 to 3°C during the daytime. Therefore, Dhaka experiences the highest temperature rise.

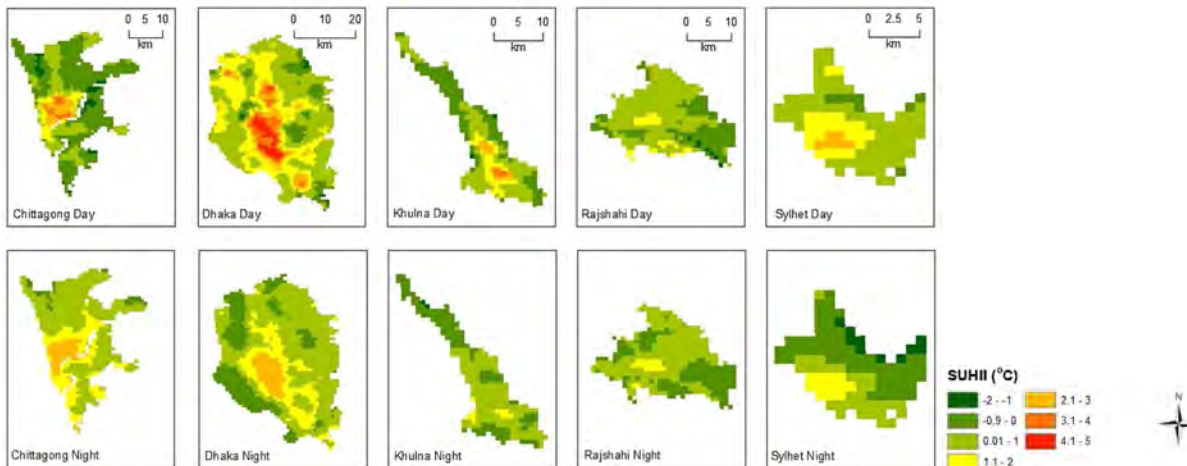

Figure 11: Spatial pattern of surface urban heat island intensity (SUHII) in five cities of Bangladesh, averaged over 2000-2019. Source: (Dewan et al. 2021)

The monthly surface urban heat island intensity (SUHII) of Dhaka is highest than all other cities of Bangladesh during the summer season. Specially, it is extremely high in March and April, which is the most critical time of the year due to the highest air temperature (Figure 12). Again, the Inter-annual day, night and day-night SUHII variability are shown in Figure 13. The Dhaka daytime SUHII exhibits a notable increase in mean temperature from 2.20°C in 2000 to 3.18°C in 2019. In contrast, the difference in SUHII during the day for other cities like, Khulna, Rajshahi and Sylhet is 0.57, 0.04 and 0.38°C, respectively, for that period. This suggests that Dhaka has experienced the greatest increase in daytime SUHII (0.98°C). It is been identified that population (in terms of city size and surface cover), lack of greenness and anthropogenic forcing were major factors affecting SUHII (Dewan et al. 2021).

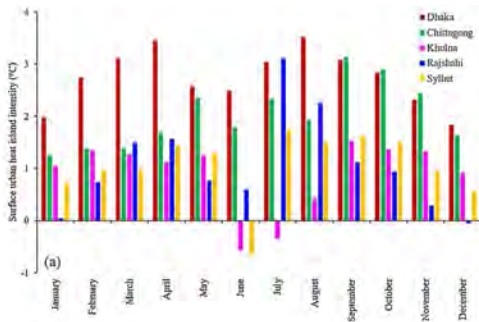

Figure 12: Monthly surface urban heat island intensity (SUHII) in five major cities of Bangladesh, 2010-2019. Source: (Dewan et al. 2021)

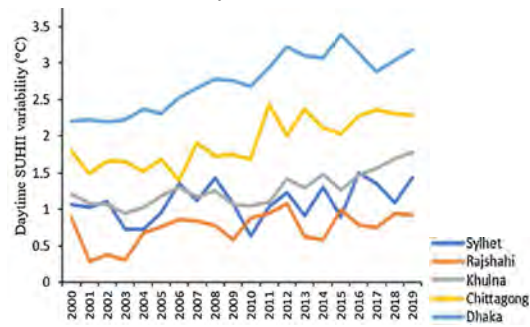

Figure 13: Variability of surface urban heat island intensity (SUHII) in five major cities of Bangladesh, 2010-2019. Source: (Dewan et al. 2021)

Another study assessed the effects of urban heat island in Dhaka city, Bangladesh from 2002 to 2014 using remote sensing techniques (Parvin and Abudu 2017). Land cover changes were characterized over the study period and the resulting impacts created by these changes on the land surface temperatures were investigated. The land surface temperature (LST), the radiative temperature of the land surface as measured in the direction of the remote sensor, were evaluated and quantified based on different land cover types of Dhaka City (Parvin and Abudu 2017). Remarkable change in land cover was observed in built-up areas, which increased by 21 percent of the total land area from 74.12 to 135.36 square kilometers in 2002 and 2014 respectively (Figure 14). The study also identified that land surface temperature (Figure 15) increased throughout the study area.

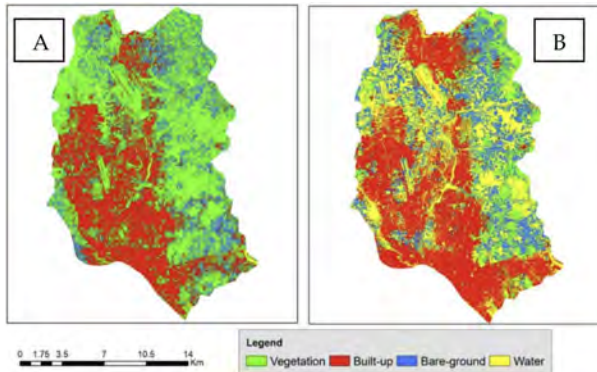

Figure 14: Land cover change map for Dhaka from 2002 (A) to 2014 (B). Source: (Parvin and Abudu 2017).

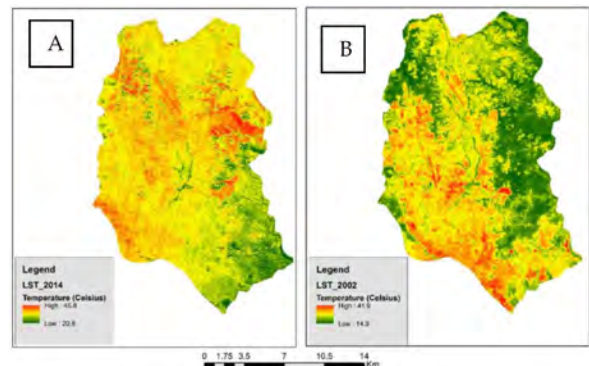

Figure 15: Land Surface Temperature changes in Dhaka City from 2014 (A) to 2002 (B). Source: (Parvin and Abudu 2017).

By investigating the temperature variation with land cover in Dhaka, Parvin and Abudu have identified a temperature increase across all land cover types within 2002-2014, indicating significant UHI effects in the Dhaka city (Parvin and Abudu 2017). It has been identified that the percentage of built-up area, bare-ground and water area have increased from 2002 to 2014, however, only the percentage of land cover by vegetation is significantly decreased from about 48 to 14 percent (Figure 16), consequently, the temperature has also risen in the vegetated surface (Figure 17). Therefore, the reduction of green and vegetated surface is one of the major reasons of the UHI effects in the Dhaka City. This study has observed that the total area covered by built-up area increased by 61.24 square kilometers over a twelve-year period from the 74.12 square kilometers observed in 2002. This increment is expected to continue over the next decade with an increase in vegetation loss. Therefore, effective strategies such for urban greening is highly recommended to curb the heating effects.

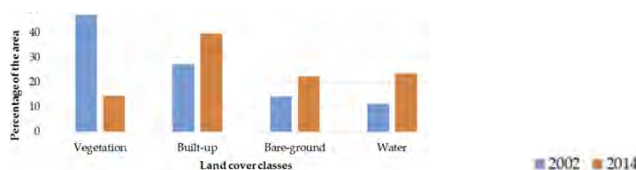

Figure 16: Percentage of land cover in Dhaka City in 2002 and 2014. Source: (Parvin et al, 2017)

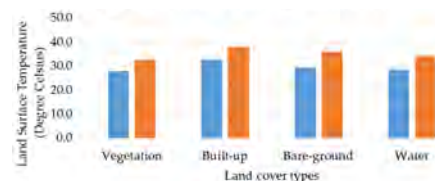

Figure 17: Temperature variation for land cover in Dhaka City in 2002 and 2014. Source: (Parvin et al, 2017)

By the systematic review of this paper, it can be stated that the followings are some of the major contributing factors of UHI effects in Dhaka City.

- Rapid urban migration to Dhaka City (in terms of city size and surface cover).
- Substantial reduction of existing natural vegetated surfaces, green area, vegetation is one of the major reasons for the UHI effects in Dhaka.

- Remarkable increase of built-up area in the land cover of the city by the dense urban expansion, significantly altering the natural surfaces to impervious areas, which is causing amplified land surface temperature. A significant rise in the percentage of built-up area and the bare-ground area has been observed, whereas only the percentage of land cover by vegetation has been dramatically decreased.

An urban microclimate is the consequence of several parameters, such as the size of the city, orientation and width of streets, density of the built-up area and the presence of parks, other green areas and water bodies. It can be controlled through a careful arrangement of green parks, vegetations, waterbodies and urban blocks with mutual shading. Dhaka is one of the fastest growing mega cities in the world that have been oversaturated with population and thriving further for large scale developments to accommodate the huge influx of migrants. As a result, the overall city environment is being worsened. Very little research has been conducted in this field based on Dhaka since this is still a quite new concept among the local urban planners and climatologists. Ahmed (1995) has worked on approaches to bioclimatic urban design with special reference to Dhaka where he studied influence of greenery on urban microclimate in the context of Dhaka. His findings revealed that trees are quite effective for creating cooling effect through shading, particularly east-west elongated canyons. In another study conducted on the urban canyon geometry of the Dhaka city center area with respect to sky view factor, a positive relation between sky view factor and solar radiation was identified irrespective of seasonal variation (Kakon and Nobuo, 2009). Parks and green spaces of Dhaka City are now converted into urban habitats. Today, very few green areas exist within the city boundary as the reminiscence of past green glory (Islam, 2002). Dhaka possesses only 0.12 acres of vegetated and open areas per thousand people. According to the National Recreation and Park Association (NRPA) recommendations, a range between 6.25 and 10.5 acres of total open space per thousand members of the population is needed. Planting of vegetation in urban areas is one of the main strategies to mitigate the UHI effect since vegetation plays a significant role in regulating urban climate. Plants can create an 'oasis effect' and mitigate the urban warming at both macro and micro-level through evapo-transpiration (Wong, 2004). However, the Urban Heat Island effect is embedded in a complex climatic system influenced by several factors such as population density, land use, land cover, altitude, proximity to sea and sea breezes (Lin 2008). Therefore, it is challenging to isolate the contributions of various factoring agents. Multiple approaches and data such as the use of GIS and Remote Sensing techniques, ground-based temperature measurements and geostatistical analysis, etc. should be incorporated for further studies.

6.0 CONCLUSION

It is highly recommended to increase the percentage of the green spaces and vegetated surfaces to mitigate the UHI effects of Dhaka. Bangladesh has a rich variety of flora that needs to be explored and a green database needs to be formed by Government initiative that can act as a guideline for planners. In conclusion, this paper indicates that there is urgent need for the city authority to implement measures to monitor and mitigate the UHI effects in Dhaka city. As a next step of this research, several strategies for mitigating UHI will be simulated for new development in Dhaka city and recommendations will be made for future expansion.

ACKNOWLEDGEMENTS

This research is supported by the Penn State Department of Architecture. Software and equipment for this study is provided by Ecology + Design (E+D) and the Hamer Center for Community Design.

REFERENCES

- Ahmed, K.S. (1995). *Approaches to bioclimatic urban design for the tropics with special reference to Dhaka, Bangladesh*. PhD Dissertation, Environment and Energy Studies Program, Architectural Association School of Architecture, London, UK
- Ahmed, Khandaker Shabbir. 2003. *Comfort in Urban Spaces: Defining the Boundaries of Outdoor Thermal Comfort for the Tropical Urban Environments*. *Energy and Buildings* 35 (1): 103–10. [https://doi.org/10.1016/S0378-7788\(02\)00085-3](https://doi.org/10.1016/S0378-7788(02)00085-3).
- Ahmed Z N.1994. *Assessment of Residential Sites in Dhaka with respect to Solar Radiation Gains*. Unpublished Ph. D. thesis, De Montfort University; UK.
- ASHRAE 55-74 Standards. 1974. *Thermal Environmental Conditions for Human Occupancy*.
- Bangladesh Bureau of Statistics. 2013. *Statistical yearbook of Bangladesh 2012 (34th ed.)*. Dhaka, Bangladesh: from <http://www.bbs.gov.bd/WebTestApplication/userfiles/Image/SubjectMatterDataIndex/YB-2014.pdf>, Accessed on 7May 15.
- Bangladesh Meteorological Department, Climate Division, Agargoan, Dhaka, 2011
- Bangladesh Meteorological Department, Climate Division, Agargoan, Dhaka, 2012.
- Chowdhury, M.H. K. and Debsharma, S.K. 1992. *Climate change in Bangladesh – A statistical review*, Report on IOC-UNEP Workshop on Impacts of Sea Level Rise due to Global Warming, NOAMI,16-19 November 1992, Bangladesh.
- Climate Risk Index (CRI) 2021, <https://germanwatch.org/en/19777>, Accessed on 10 November 2021.
- Corner, R. J. & Dewan, A. M. 2013. *Dhaka megacity: Geospatial perspectives on urbanisation, environment and health*. Dordrecht, Netherlands: Springer Netherlands.
- Dewan, Ashraf, Grigory Kiselev, Dirk Botje, Golam Iftekhar Mahmud, Md. Hanif Bhuiyan, and Quazi K. Hassan. 2021. *Surface Urban Heat Island Intensity in Five Major Cities of Bangladesh: Patterns, Drivers and Trends*. *Sustainable Cities and Society* 71 (August): 102926. <https://doi.org/10.1016/j.scs.2021.102926>.
- Divya, Mehritra, R.1995. *Climate Change and hydrology with emphasis on the Indian subcontinent*. Hydrologic Sciences Journal, 40, pp.231-241.
- Draft Dhaka Structure Plan,https://www.academia.edu/31508051/_Draft_Dhaka_Structure_Plan_Report_2016_2035_Full_Volume_, accessed on 07 November 2021.
- Eckstein, David, Vera Kunzel, Laura Schafer, and Germanwatch. 2021. *Global Climate Risk Index 2021 Who Suffers Most Extreme Weather Events? Weather-Related Loss Events in 2019 and 2000-2019*.

- Gaitani, N., G. Mihalakakou, and M. Santamouris. 2007. *On the Use of Bioclimatic Architecture Principles in Order to Improve Thermal Comfort Conditions in Outdoor Spaces*. *Building and Environment* 42 (1): 317–24.
- Girardet, H. (2020). People and nature in an urban world. *One Earth*, 2(2), 135–137.
- Gong, P., Li, X., Wang, J., Bai, Y., Chen, B., Hu, T., ... Zhou, Y. (2020). *Annual maps of global artificial impervious area (GAIA) between 1985 and 2018*. *Remote Sensing of Environment*, 236, Article 111510.
- Grimmond, S. U. (2007). Urbanization and global environmental change: Local effects of urban warming. *The Geographical Journal*, 173(1), 83–88.
- Guhathakurta, S., & Gober, P. 2007. *The impact of the Phoenix urban heat island on residential water use*. *Journal of the American Planning Association*, 73, 317–329.
- Heisler, G. M., & Brazel, A. J. 2010. *The urban physical environment: Temperature and urban heat islands*. *Urban ecosystem ecology*, 55, 29–56
- Hossain, M.E., and Nooruddin, M. 1993. *Global Solar Radiation on Horizontal Surface in Dhaka*. International Technical Conference on Tropical Urban Climates, Dhaka.
- Huang, X., Huang, J., Wen, D., & Li, J. 2021. *An updated MODIS global urban extent product (MGUP) from 2001 to 2018 based on an automated mapping approach*. *International Journal of Applied Earth Observation and Geoinformation*, 95, Article 102255.
- Huq, S. 2001. *Climate change and Bangladesh*. *Science*, 294(5547), 1617–1618.
- IPCC 2007, <https://www.ipcc.ch/report/ar4/syr/>, accessed on 07 November 2021.
- IPCC 2021, <https://www.ipcc.ch/report/ar6/wg1/>, accessed on 07 November 2021.
- Islam, S. T. (2002). *Greening and Fading the Dhaka City: Past, Present and Future Perspectives*, Unpublished Project Report. Dhaka: The Asiatic Society of Bangladesh
- Johansson, Erik, and Rohinton Emmanuel. 2006. *The Influence of Urban Design on Outdoor Thermal Comfort in the Hot, Humid City of Colombo, Sri Lanka*. *International Journal of Biometeorology* 51 (2): 119–33.
- Kakon, A. N., Nobuo, M. (2009). *The sky view factor effect on the microclimate of a city environment: A case study of Dhaka city*. Paper presented at the 7th International Conference on Urban Climate, Yokohama, Japan. Available at http://www.ide.titech.ac.jp/~icuc7/extended_abstracts/pdf/384760-1-090513144446-003.pdf, Accessed on 17 June, 2010.
- Kant, Y., Azim, S., & Mitra, D. 2018. *Analyzing the influence of urban growth on thermal environment through demographic, environmental, and physical parameters in Bangladesh*. Land-atmospheric research applications in south and Southeast Asia (pp. 613–639). Cham: Springer.
- Karmakar, S. and Shrestha, M.L. 2000. *Recent climate change in Bangladesh*, SMRC No.4, SMRC, Dhaka.
- Lean, G. 1990. *Atlas of the Environment*. Arrow books Ltd., London.
- Lin, F. J. 2008. *Solving multicollinearity in the process of fitting regression model using the nested estimate procedure*. *Quality & Quantity*, 42(3), 417–426.
- Kotharkar, R., Ramesh, A., Bagade, A. 2018. *Urban heat island studies in South Asia: A critical review*. *Urban Climate*, 24, 1011–1026.
- Mallick, F. H., 1994. *Thermal Comfort for Urban Housing in Bangladesh*, PhD Thesis (Unpublished), EESP, Architecture Association, London, 1994.
- Mia, N.M. 2003. *Variations of temperature of Bangladesh*. In Proceedings of SAARC Seminars on Climate Variability In the South Asian Region and its Impacts, SMRC, Dhaka.
- Mourshed, M. 2011. *The impact of the projected changes in temperature on heating and cooling requirements in buildings in Dhaka, Bangladesh*. *Applied Energy*, 88(11), 3737–3746.
- Mridha, A. M. M. H., 2002. *A study of thermal performance of operable roof insulation, with special reference to Dhaka*, Masters thesis (unpublished), Bangladesh University of Engineering and Technology, Dhaka, Bangladesh.
- National Recreation and Park Association (NRPA), <https://www.nrpa.org/>, accessed on 10 November 2021.
- Nikolopoulou, Marialena, Nick Baker, and Koen Steemers. 2001. *Thermal Comfort in Outdoor Urban Spaces: Understanding the Human Parameter*. *Solar Energy* 70 (3): 227–35. [https://doi.org/10.1016/S0038-092X\(00\)00093-1](https://doi.org/10.1016/S0038-092X(00)00093-1).
- Nikolopoulou, Marialena, and Koen Steemers. 2003. *Thermal Comfort and Psychological Adaptation as a Guide for Designing Urban Spaces*. *Energy and Buildings*, Special issue on urban research, 35 (1): 95–101. [https://doi.org/10.1016/S0378-7788\(02\)00084-1](https://doi.org/10.1016/S0378-7788(02)00084-1).
- Oke, T. R. 1982. *The energetic basis of the Urban Heat Island*. *Quarterly Journal of the Royal Meteorological Society*, 108, 1–24.
- Parthasarathy, B., Sontake, N.A., Monot, A.A., and Kothawale, D.R. 1987. *Drought-flood in the summer monsoon season over different meteorological subdivisions of India for the period 1871-1984*, *Journal of Climatology*, 7, pp.57-70.
- Parvin, Nigar Sultana, and Dan Abudu. 2017. *Estimating Urban Heat Island Intensity Using Remote Sensing Techniques in Dhaka City*. *International Journal of Scientific & Engineering Research* 8 (4): 289–98. <https://doi.org/10.14299/ijser.2017.04.009>.
- Rai, R., Zhang, Y., Paudel, B., Li, S., & Khanal, N. R. 2017. *A synthesis of studies on land use and land cover dynamics during 1930–2015 in Bangladesh*. *Sustainability*, 9(10), 1866.
- Rajdhani Unnayan Kartripakkha. 2015. *Dhaka structure plan 2016–2035*. Dhaka, Bangladesh: Author. <https://www.rajukdhaka.gov.bd/rajuk/image/slideshow/1.%20Draft%20Dhaka%20Structure%20Plan%20Report%202016-2035%28Full%20%20Volume%29.pdf>, accessed on 07 August 2016.
- Rashid, Haroun. 1991. *Geography of Bangladesh*, 2nd Ed., The University Press Ltd., Dhaka, Bangladesh.
- Shahjahan, A. 2012. *An Investigation of indoor Thermal Comfort Range for Rural Houses of Dhaka Region*, Masters thesis (unpublished), Bangladesh University of Engineering and Technology, Dhaka, Bangladesh.
- Sharmin, Tania, Saimum Kabir, and Md Rahaman. 2012. A Study of Thermal Comfort in Outdoor Urban Spaces in Respect to Increasing Building Height in Dhaka." *AIUB JOURNAL OF SCIENCE AND ENGINEERING (AJSE)*, 11 (August).
- Siddique, A. B. 2014. *Rooppur plant lacks proper assessment*. Dhaka Tribune. Retrieved from <http://archive.dhakatribune.com/environment/2014/feb/16/environmentalists-rooppur-plant-lacks-proper-assessment>. Accessed on 12 August 2010.
- United Nations. 2015. *World Urbanization Prospects: The 2014 Revision* (No. ST/ESA/SER.A/366). Retrieved from <http://esa.un.org/unpd/wup/Publications/Files/WUP2014-Report.pdf>. Accessed on 15 November 2021.
- World Atlas Travel* [online]. 2014. URL: <http://www.worldatlas.com/aatlas/world.htm>. Accessed on 31 January 2014.
- Wong N. H., 2004. *Study of urban heat island in Singapore*. Research report, National University of Singapore.
- World Bank, 2000. *Bangladesh: Climate Change and Sustainable Development*. Report No. 21104-BD", Rural Development Unit, South Asia Region, The World Bank (WB), Dhaka, pp. 95.
- World Business Council for Sustainable Development. 2007. *Energy efficiency in buildings: Business realities and opportunities*. Switzerland. Retrieved from <http://www.c2es.org/docUploads/EEBSummaryReportFINAL.pdf>. Accessed on 07 July 2014.

Water, Fire, Land, Air: Investigating Land-based Infrastructures

Jessica Rossi-Mastracci¹

¹University of Minnesota, Minneapolis, MN

ABSTRACT: Land-based infrastructures (LBI) operate broadly in a wide range of climates, environments, and cultures, both throughout history, as at Chaco Canyon in the 9th-13th Centuries (Bryan 1954) and the *acequia* system in New Mexico in use continuously since the 16th Century (Fleming 2014), and today by land-managers, ecologists, and hydrologists (Leopold 1994; Zeedyk 2009; Lancaster 2013; Margolis 2015). LBI utilize simple construction techniques, such as digging, stacking, and piling, and are deployed across an underlying framework or organization to leverage biophysical and natural systems, providing both human well-being and biodiversity benefits. Using Taxonomy and Typology as working methods, this research project investigates land-based water, fire, land, and air infrastructures from design, engineering, hydrology, history, and anthropology through drawing, 3d modeling, and diagramming. Typology creates a classification scheme (Rossi-Mastracci 2020; Deming and Swaffield 2011) and Taxonomy organizes, establishes relationships, and analyzes impacts (Deming and Swaffield 2011). This combination can be used as a new methodology for designers to engage in research as part of the design process, enhancing our understanding of “design as research.” Findings from this research reveal that: subtle manipulations in landform and use of organic materials can create complex conditions that emerge over time; a range of new actions, such as weaving, layering, and cultivating can inspire new material assemblies and typologies; infrastructures can be climate-adaptable and formally flexible, responding to resource availability and adapting quickly to environmental changes; and designing built infrastructures and material assemblies based on the critical relationship between weather, climate, vegetation, and time can lead to new performative actions. Future work by the author will investigate how the embedded knowledge in LBI typologies can inform material assemblies, form, and performance of urban infrastructures to position cities, landscapes, and the built environment to be adaptable in the face of uncertain futures.

KEYWORDS: Infrastructure, Climate Change, Design Research, Built Environment, Landscape Architecture

INTRODUCTION

Land-based infrastructures (LBI) are used in a wide range of climates, environments, and cultures by ecologists, landscape architects, designers, land managers, and hydrologists to modify and intervene at a range of landscape scales (Leopold 1994; Zeedyk 2009; Lancaster 2013; Margolis 2015; WOCAT online; IUCN online; Bridges 2018; World Bank 2021). These design interventions utilize simple construction techniques, such as digging, stacking, and piling, while simultaneously leveraging scarce resources, such as water to establish vegetation, create animal habitat, and filter pollutants to support human programming and engagement opportunities (Doolittle 2000). Examples throughout history and present day support the importance of LBI and their role in large-scale landscape transformation, enabling human settlements in extreme environments and restoring vulnerable ecosystems (Bryan 1954; Doolittle 2000).

This paper explores a case study of four drawings that investigate land, water, fire, and air LBI. These drawings utilize a combination of Taxonomy and Typology to compare sets of infrastructures, unpacking multiple overlapping benefits, site suitability, landscape performance, and formal and material characteristics. They aim to describe a set of infrastructural typologies generally unknown to the broader Landscape Architectural and Architectural communities. Findings reveal new ideas about landscape performance, material assemblies, and infrastructural systems. The embedded knowledge within LBI generated through thousands of years of continuous use has the potential to be an inspiration to develop new infrastructural typologies and material assemblies that could reduce our dependence on single-function infrastructures and carbon-intensive materials, positioning urban landscapes as adaptable in the face of uncertain futures.

1.0 DEFINING “LAND-BASED INFRASTRUCTURES”

1.1 Why “land-based” and not another term?

Some refer to land-based design interventions as simply “low-tech,” or primitive, unsophisticated techniques developed before the Industrial Revolution, often places in opposition with “high-tech” interventions or those that rely on advanced technologies, materials, and systems (Watson 2019). This refers to the assumption that low-tech and land-based

interventions are unsophisticated, using natural or found material such as rock, compacted soil, and landforming, rather than innovative material assemblies, such as permeable concrete and engineered structural soil. However, high-tech interventions may require frequent repair, specialized skills to install, are carbon-intensive at every step, and are expensive where low-tech interventions are adaptable, use on-site materials, and are often net-positive or regenerative (Hawken 2017) (Figure 1).

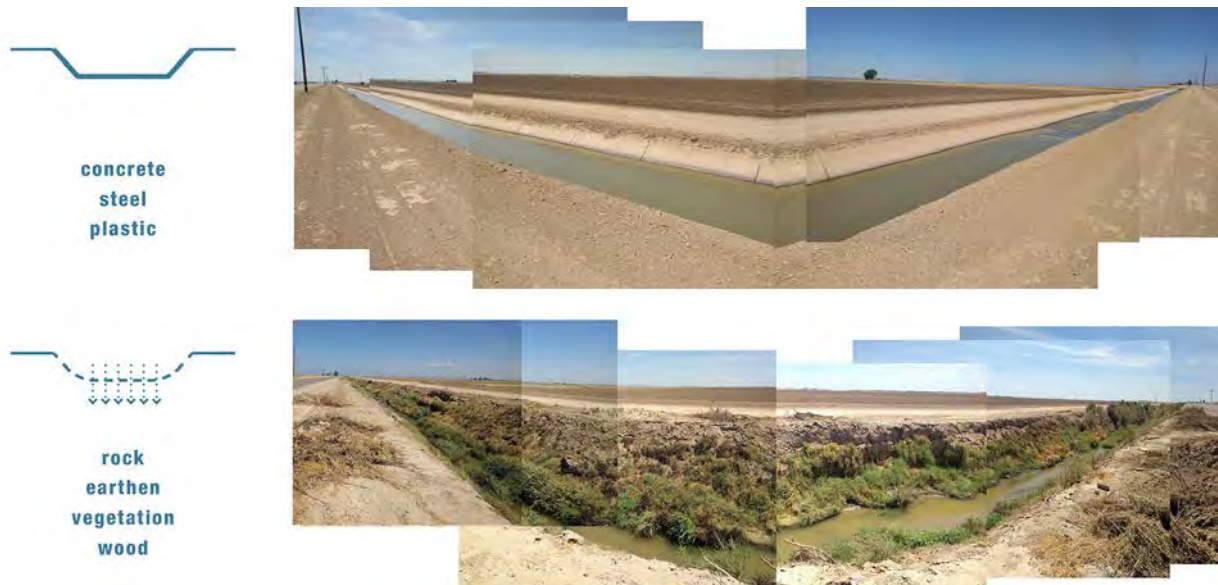

Figure 1: ‘High-tech’ interventions vs. ‘Low-tech’ land-based interventions. Source: (Author 2019)

Low-tech interventions have had outsized impacts throughout history. A notable historic example is Chaco Canyon, a civilization located in the arid and water-scarce Colorado Plateau and active from the 9th-13th centuries until abandoned due to extended drought (Bryan 1954). Using simple landforming moves like terracing, leveling, and excavating, the Chacoans created a complex regional network with over 200 small villages and large urban centers, water infrastructure that captured and diverted runoff water from adjacent *arroyos* (dry stream beds) for domestic use and irrigation, and a circulation infrastructure navigating rocky and steep terrain (Bryan 1954). These complex urban, ecological, transportation, and economic armatures used simple construction techniques and locally available materials, and many are still visible in the landscape and continue to perform as designed.

As well, many of these infrastructures are currently in use today by ecologists, landscape architects, hydrologists, and land managers to modify and intervene at a variety of landscape scales (Leopold 1994; Zeedyk 2009; Lancaster 2013; Margolis 2015; WOCAT online; IUCN online; Bridges 2018; Fleming 2014). These soft landscape systems manage and slow stormwater in urban environments, re-meander incised channels, restore habitat areas as well as establish novel ones in urban and rural environments, protect shorelines from storm surges and introduce biodiversity, and capture scarce runoff water for agricultural irrigation. They are known under many different frameworks, such as “Nature-based Solutions” (NbS), “Engineering with Nature” (EWN), and “Sustainable Land Management Technologies” (SLM Technologies). Each refers to the specific interventions differently, such as “actions” (NbS; World Bank 2021), “technologies” (SLM; WOCAT online), “projects” or “strategies” (EWN; Bridges 2018), but all encompass interventions that primarily use landforming and on-site materials in their construction.

To describe these interventions similarly, a term is needed that is more expansive than “low-tech,” more specific than “approaches” or “projects,” suggests scalability, and can encompass complexity.

1.2 Defining “Land-based Infrastructures” (LBI)

Referring to these interventions as “land-based” gives us that additional specificity. The phrase describes interventions as ways to manipulate land, and form is highly important, including the shape, slope, scale, and materiality, as well as how they interact with landscape systems above and below ground (Doolittle 2000). By utilizing simple landforming techniques, they are easily repaired, flexible enough to work in a range of conditions, including from inundation to drought, and can be adjusted, adapted, or relocated depending on conditions (WOCAT online; Watson 2019; Zeedyk 2009; Lancaster 2013; IUCN online).

These land-based interventions operate at multiple scales and by linking them together as a series or system they can operate at a larger, urban and landscape infrastructural scale, as NbS suggests (IUCN online; World Bank 2021). Thus, adding the word “infrastructure” shifts the conversation from a singular element to this larger scale, as infrastructure becomes the frame, skeleton, or framework of interventions operating as a system (Belanger 2016; Hung and SWA Group 2013). As well, thinking about infrastructure as “soft” and “resilient,” rather than “hard” and “fixed,” expands our definition to encompass the inherent adaptation capabilities within land-based interventions. A “soft” framework allows for diversity of forms and programs, emergence, and informal collection within an organizational structure (Bhatia 2012). This establishes that these land-based interventions operate complexly and impact landscapes at multiple scales, becoming a form of infrastructure that can change or evolve over time dynamically and organize multiple large-scale systems, such as ecology, hydrology, transportation, and urbanism.

The term “land-based infrastructures” (LBI) gives us new potential, encompassing the way in which these interventions are implemented (manipulating land through simple construction techniques such as digging, berming, and compacting) and the scale at which these interventions can have impact (deployed across an underlying framework or organization to leverage biophysical and natural systems and provide both human well-being and biodiversity benefits).

2.0 METHODOLOGY

2.1. Research Methodology + Sources

The author, a licensed Landscape Architect and Assistant Professor in Landscape Architecture, came across a series of interventions previously unknown in their professional and academic experience. Through research, they discovered the larger potential for these land-based infrastructures to help reduce dependence on carbon-intensive materials in design and be another tool in climate-adaptive design.

The author wanted to describe LBI to the larger landscape architectural and design community, highlighting alternative infrastructures, construction techniques, and material assemblies that manipulate land, direct air, utilize fire, and leverage site water. A new method of research and representation was needed to describe the inherent complexity of LBI within one drawing, rather than across multiple types, and synthesize performative and formal characteristics. To do this, the author combined aspects of Taxonomy and Typology, using Typology to establish a classification scheme and a consistent mode of representation (Condon 1994; Moneo 1978; Masoud 2017; Deming and Swaffield 2011; Rossi-Mastracci 2020) and Taxonomy to organize, establish relationships, and analyse impacts (Mayr 1969; Deming and Swaffield 2011).

2.2 Developing the Drawings // Taxonomy and Typology

Taxonomy has its roots in Systematic Biology (“Systematics”), which is the branch of biology that deals with classification. The three parts of Systematics, “Taxonomy,” “Classification,” and “Phylogeny,” classify, organize, describe, and name living beings, as well as establish relationships between living and ancient organisms (Mayr 1969). Most relevant to this research is “Phylogeny,” which classifies organisms based on common characteristics, using a branching “tree-like” diagram, or a cladogram, that “depicts species divergence from hypothetical common ancestors” and shared characteristics (Mayr 1969). Taxonomy can be used to organize information hierarchically, beginning with broad categories and ending with the most specialized in a series of “divisible” and “superimposed or ‘nested’ scales” (Deming and Swaffield 2011).

In Foreign Office Architect’s *Phylogenetic Tree*, the firm used taxonomy to categorize and analyze their own architectural work (Foreign Office Architects 2004; Figure 2). They used this drawing to describe architectural form and identify self-determined “gaps” in their practice that could be fulfilled by expanding their range of formal design responses. As well, the firm aimed to use this drawing to build an identity of their practice, using icons, axons, and diagrams to draw consistency and allow for comparison across typologies.

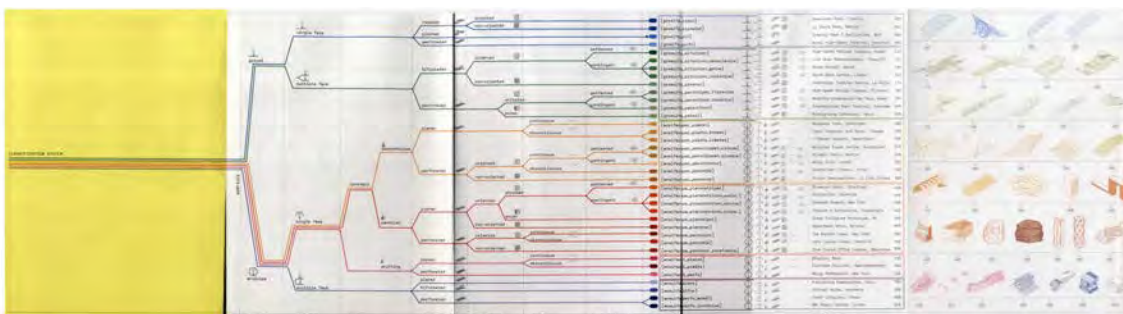

Figure 2: Taxonomy, Foreign Office Architect’s “Phylogenetic Tree.” Source: (FOA, 2004).

Typology can be used as a classification scheme to simplify and organize information based on patterns, form,

materials, and general site conditions. These broad characteristics allow for comparison between infrastructure types, rather than specific design interventions (Rossi-Mastracci 2020; Deming and Swaffield 2011). This lens can be utilized to describe typical design conditions that may occur in many locations or instances (Rossi-Mastracci 2020; Condon 1994; Moneo 1978; Masoud 2017), simplifying multiple complexities into common conditions or common characteristics.

Using Typology gives us a framework both for which interventions are included and how they are represented. This can be used to describe basic or broad characteristics, in this case physical form, to allow for comparison across a wide range of interventions. For example, using simple line drawings to describe an iterative series of plans in a simple and consistent way, creates a “frame within which change operates” (Figure 3, Moneo 1978). Drawing in axonometric gives more information about each typology where we can see the three-dimensional form, change across space, and materials and scale (Wallis and Rahmann 2016; Pleijster and van der Veeke 2015).

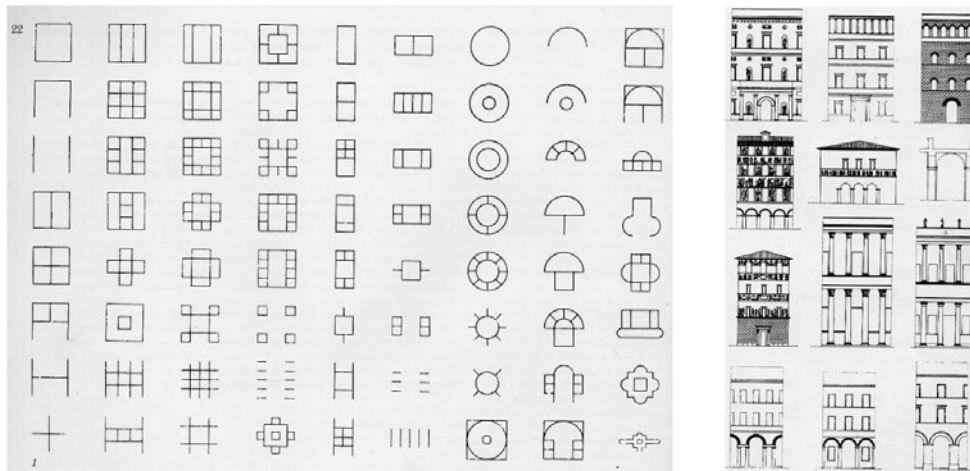

Figure 3: “On Typology.” Source: (Moneo, R., 1978).

3.0 FINDINGS

These findings are described in a series of four drawings, exploring the use of Taxonomy and Typology as a research and representation framework. Typology establishes a classification scheme and consistent representation mode for the set of information, allowing for easy comparison between infrastructures. This creates a methodology to evaluate which infrastructures are included, focusing generic or site-less rather than highly site-specific infrastructures. For example, both “furrow micro-catchments” used in Kenya and “Nardi/Vallerani trenches” used in Niger, utilize a series of small trenches dug along hillside contours to collect water (WOCAT, online). Understanding this, we can simplify to “small contour trenches” without losing fundamental formal and performative aspects of either.

Taxonomy organizes and classifies the sets of interventions into smaller inclusive groups to visualize diversity, similarities, and relationships. Categories are organized hierarchically, beginning with the most general characteristics then become more specific, such as beginning with “slope” and ending with “primary purpose.” Each taxonomy drawing is composed of infrastructures with similar or shared properties, structured around specific themes, and that can be organized into “nested” scales with related characteristics and classified.

The four drawings reference multidisciplinary sources from architecture, landscape architecture, engineering, hydrology, land management, history, and anthropology, highlighting the larger applicability and reach of LBI.

3.1 Water

The “Taxonomy of Water Infrastructures” (Figure 4) includes LBI that manipulate land to capture, direct, slow, and filter rain, wastewater, river, runoff, and groundwater. Each infrastructure utilizes landform and/or on-site materials such as stone, vegetation, and organic material. Sources include *Rainwater Harvesting for Drylands and Beyond* (2013), a manual that details land-based interventions for collecting and slowing rainwater, *Cultivated Landscapes of Native North America* (2000), an anthropological source that analyses and documents a range of interventions used by indigenous populations throughout history, *Out of water: Design Solutions for Arid Regions* (2015), which includes architectural and landscape architectural innovations, and *A View of the River* (2004), a source detailing riverine restoration at scale. The taxonomy focuses on interventions used in arid environments which all leverage scarce resources at multiple scales. These typologies are climate adaptable and formally flexible, have a range of performative qualities depending on resource availability, and can adapt quickly to environmental changes.

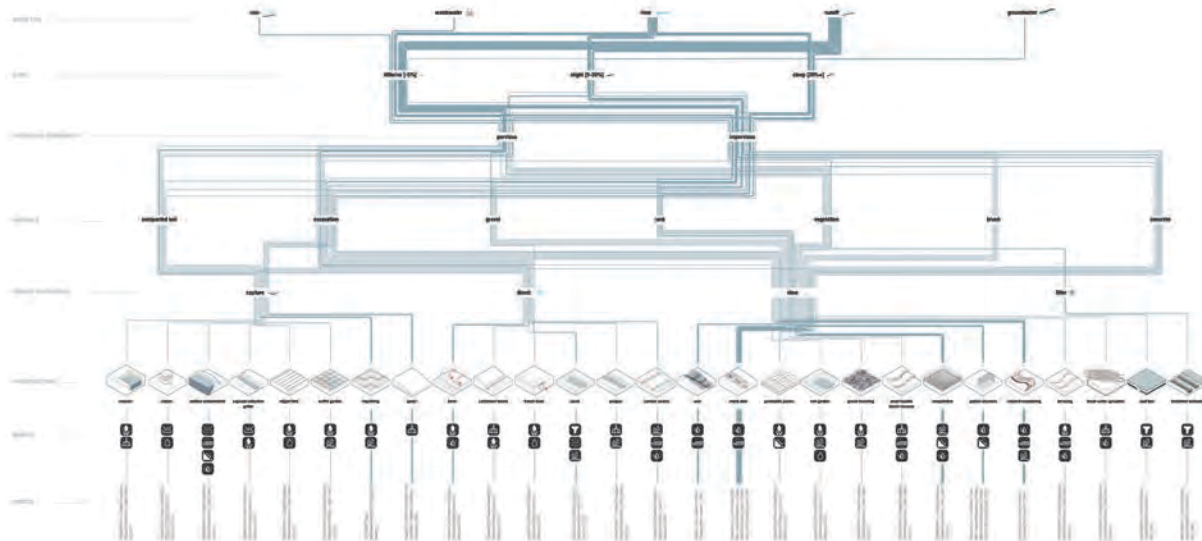

Figure 4: Taxonomy of Water Infrastructures. Source: (Author 2018-2021)

3.2 Fire

The “Taxonomy of Fire Infrastructures” (Figure 5) includes LBI and systems that manage fire in a range of landscape types, such as bare soil, prairie, brush and forest to sequester carbon, produce biochar and soil, manage species, reduce fuel, and establish settlement. Rather than viewing fire as destructive, as the case with the ongoing wildfires in Western American states, this work unpacks methods used by indigenous communities and forest managers that use fire as productive and generative. Sources *Lo-TEK: Design by Radical Indigenism* (2019), which details the influence of fire and culture on landscape maintenance, *Cultivated Landscapes of Native North America* (2000), an anthropological source on indigenous land management techniques, “Fire Management Study Unit,” a report on fire characteristics by the USDA Forest Service, and *Indigenous Land Management in Australia* (2013), detailing fire management practices utilized in Australia. The axons describe the cyclical nature of many of the infrastructures, which depend on rotating agricultural practices with burning techniques to build soil and organic matter. These highlight the relationship between weather, climate, vegetation, and time on landscape interventions.

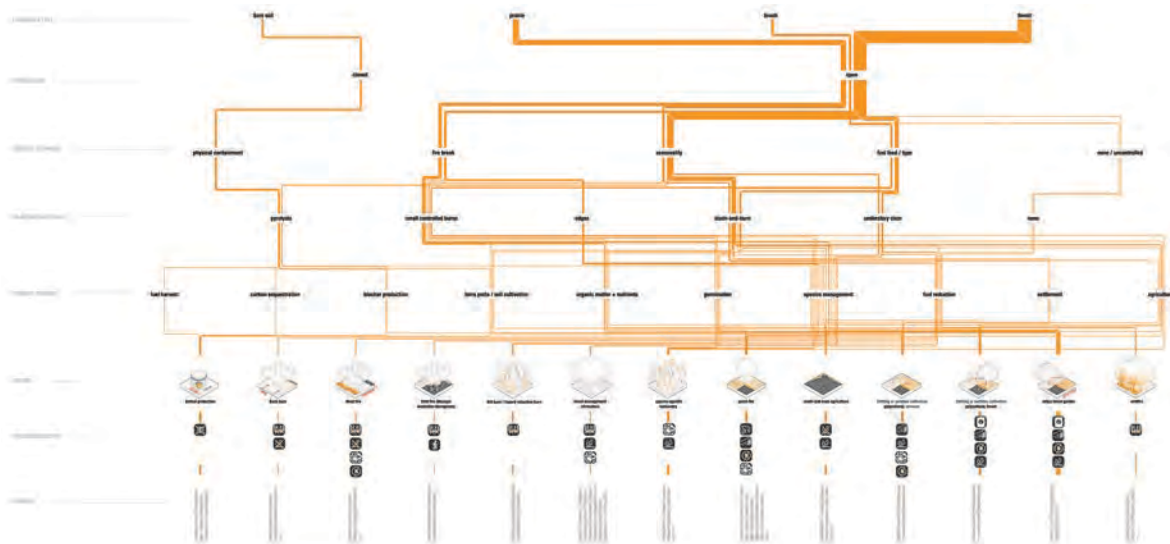

Figure 5: Taxonomy of Fire Infrastructures. Source: (Author 2020-2021)

3.3 Land

The “Taxonomy of Land Infrastructures” (Figure 6) includes LBI that manipulate land specifically for agricultural production, restoring degraded land, filtering pollutants, establishing vegetation, and moving people and animals on flat, sloped, or water sites. While many interventions seem similar, this research highlights the role of site conditions and topography on landscape performance. Sources include indigenous landscapes from *Lo-TEK: Design by Radical Indigenism* (2019) and global typologies from WOCAT’s “Global Database on Sustainable Land Management.” These infrastructures reveal how through subtle manipulations in landform and use of organic materials can create complex conditions that emerge over time. The work reveals a range of new actions, such as weaving, layering, and cultivating, that could inspire new material assemblies and surface performance.

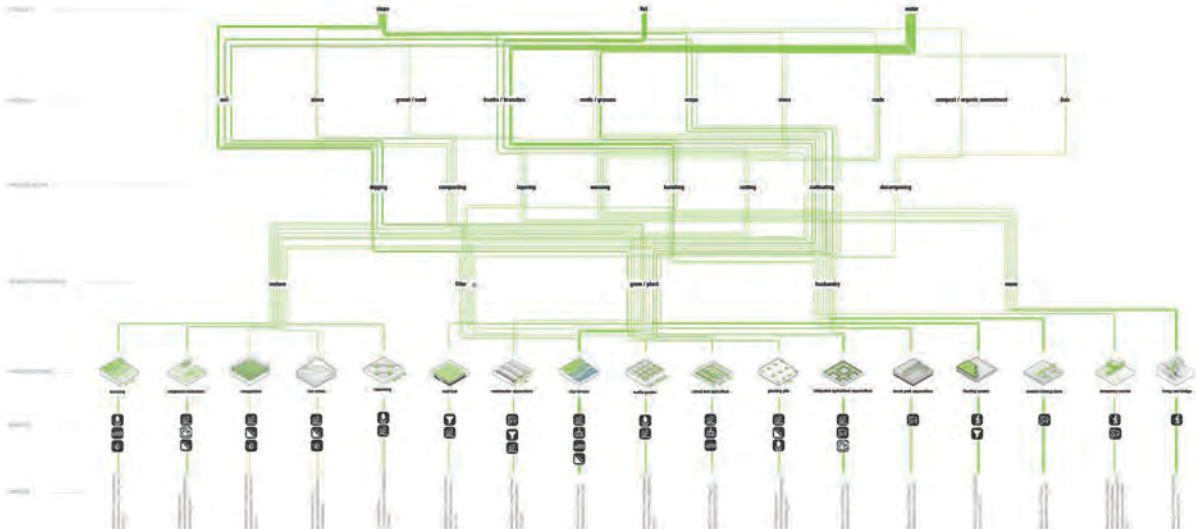

Figure 6: Taxonomy of Land Infrastructures. Source: (Author 2020-2021)

3.4 Air

The “Taxonomy of Air Infrastructures” (Figure 7) includes infrastructures that slow wind, collect dust, buffer sound, and harness solar energy through landform, planting, and simple fencing strategies. Many utilize a combination of elements, such as orientation along a slope and vegetation, highlighting the importance of environment and infrastructure. Sources are drawn from WOCAT’s “Global Database on Sustainable Land Management,” USDA National Agroforestry Center, and Natural Resources Conservation Service online databases. These infrastructures demonstrate the complex and invisible relationship between air movement and vegetation, soil, slope, and natural phenomena.

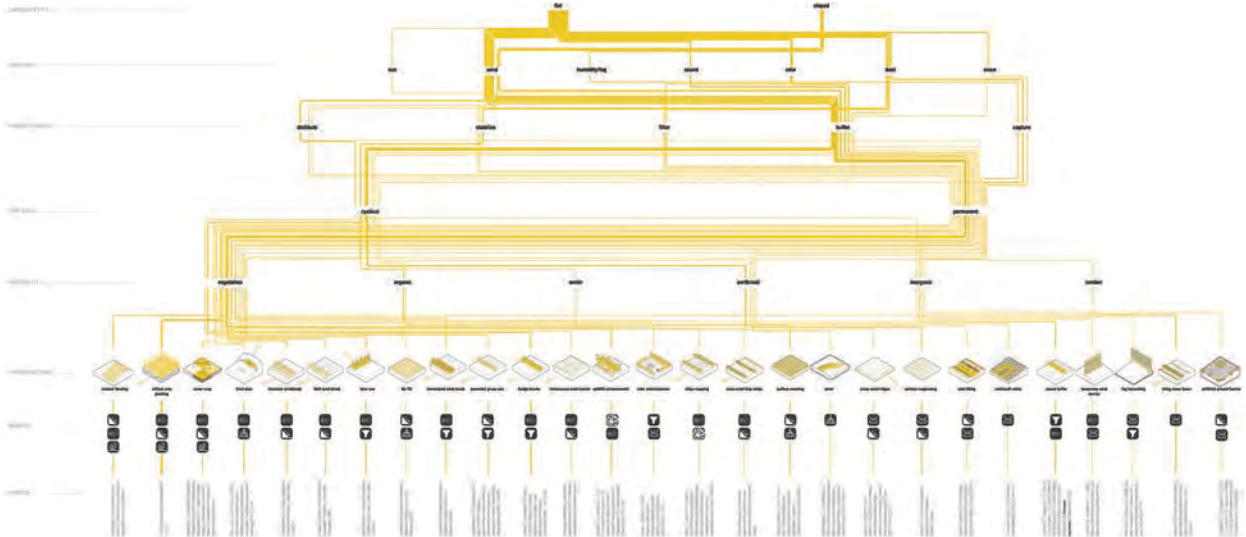

Figure 7: Taxonomy of Air Infrastructures. Source: (Author 2021)

4.0 SIGNIFICANCE

This research work on land-based infrastructures is significant for designers to integrate new materials, technologies, construction methods and systems into our urban landscape, thus expanding design vocabulary and developing a framework for design iteration and development. Unpacking these infrastructures, the drawings visualize impacts of existing site conditions such as rate of permeability, soil type, adjacencies, and locally available materials on intended benefits. Incorporating this knowledge into design creates opportunities for designers to respond to site more critically through design, develop new material assemblies that utilize on-site and regenerative materials, and expand landscape and urban performance beyond known strategies.

LBI support and create ecological benefits in service of ecological functions by controlling water, supporting biodiversity, and stabilizing vulnerable land. Through working with natural systems, such as soil conditions, weather patterns, climate, and existing or local materials, these interventions respond to resource availability and can adapt to changes in water flow, soil type, and vegetation. Designers can take inspiration from this to develop innovative urban and landscape typologies that do not rely on typical hard engineering responses, such as culverts, dams, and concrete

channels. These have the potential to be climate-adaptive, innovative, and resilient, addressing critical challenges of worsening air pollution, mitigating human health impacts due to the urban heat island effect, increasing biodiversity, and innovatively managing urban stormwater.

Utilizing Taxonomy and Typology as working methods aims to develop a framework to combine research and design work, synthesize findings, and visualize connections and relationships. It could be a new methodology for designers to engage in research as part of the design process, enhancing our understanding of “design as research.”

CONCLUSION

The larger research project investigates how the embedded knowledge in LBI can inform material assemblies, form, and function of innovative urban and landscape infrastructures that can be adaptable in the face of an uncertain future due to climate change. This work is organized into three phases: Phase 1, which this article describes, collects, organizes, and diagrams land-based infrastructural typologies to visualize and describe formal characteristics, materials, and performance. Phase 2, currently underway, analyses and dissects these typologies into the simplest form(s) or components and diagram how functions stack, complexities build, and how they perform based on geographic location, over time in response to different climate issues (water scarcity, flooding, water quality), and use this to iterate on new material assemblies, landscape typologies, and urban infrastructures. Phase 3 takes these components and iterates in response to site-specific scenarios, one in the arid Southwest and one in the Midwest. This work will take the typologies developed in Phase 2 and adapt, modify, and thicken to respond to site, climate, and scale. By investigating two sites with widely different constraints and characteristics, this work aims to explore the range and adaptability of a specific design approach.

By unpacking LBI, many that have been in use for thousands of years, we can generate new typologies that position urbanism as impermanent and flexible, reimagining the form and function of landscape and urban infrastructures. New “soft,” adaptable, and flexible infrastructures have the potential to become a counterpoint to permanent, inflexible, and static systems of contemporary urbanism. These could utilize novel materials, participate in the water cycle productively, and provide opportunities for both human and non-human engagement, moving away from single-use infrastructures to thicker infrastructures that stack multiple functions and benefits.

ACKNOWLEDGEMENTS

Funding from Kusske Design Initiative at the University of Minnesota supported research and Graduate Research Assistants. Thank you to Aubrey Olson, Torey Erin, Anya Moucha, and Marla Brown for their contributions to drawings, research, and general discussions. Thank you to Kristine Miller for your continuing guidance and editing support.

REFERENCES

- Bélanger, P., and Williams, R. 2016. *Landscape as Infrastructure: A base primer*. New York: Routledge.
- Bhatia, N. and Sheppard, L, eds. 2012. *Bracket 2: Goes Soft*, Barcelona: Actar Publishers.
- Bridges, T. et. al. 2018. *Engineering With Nature: An Atlas*. ERDC/EL SR-18-8. Vicksburg, MS: U.S. Army Engineer Research and Development Center. <http://dx.doi.org/10.21079/11681/27929>
- Bryan, K. 1954. *The Geology of Chaco Canyon, New Mexico*. City of Washington: Smithsonian Institute.
- Condon, P. 1994. “A Built Landscape Typology” in Franck, Karen and Lynda Schneekloth. eds, *Ordering Space: Types in Architecture and Design*. New York: Van Nostrand Reinhold.
- Deming, M.E., and Swaffield, S. 2011. *Landscape Architectural Research: Inquiry, Strategy, Design*. Hoboken, NJ: Wiley.
- Doolittle, W. 2000. *Cultivated Landscapes of Native North America*. Oxford: Oxford University Press.
- Fleming, W. et. al. 2014. ‘Ecosystem services of traditional irrigation systems in northern New Mexico, USA,’ *International Journal of Biodiversity Science, Ecosystem Services & Management*, 10:4, 343-350, DOI: 10.1080/21513732.2014.977953
- Foreign Office Architects. 2004. *Phylogenesis: FOA’s ark*. Barcelona: Actar Publishers.
- Hawken, P. 2017. *Drawdown: The most comprehensive plan ever proposed to reverse global warming*. New York: Penguin Books.
- Hill, M., et. al. 2013. *Indigenous Land Management in Australia*. Cairns: CSIRO Ecosystem Sciences.
- Hung, Y. and SWA Group. 2013. *Landscape Infrastructure: Case studies by SWA (2nd & rev. ed.)*. Basel: Birkhäuser.
- IUCN Definitional Framework on Nature-based Solutions, 2016 World Conservation Congress; <https://www.iucn.org/theme/ecosystem-management/our-work/iucn-global-standard-nature-based-solutions>
- Lancaster, B. 2013. *Rainwater Harvesting for Drylands and Beyond*. United States: Rainsource Press.
- Leopold, L. 1994. *A View of the River*. Cambridge, MA: Harvard University Press.
- Margolis, L. 2015. *Out of Water: Design Solutions for Arid Regions*. Basel; Boston: Birkhäuser.
- Masoud, F. 2017. “Coding Flux: Redesigning the Migrating Coast.” *Scenario Journal 06: Migration*. Retrieved April 16, 2018. <https://scenariojournal.com/article/coding-flux>
- Mayr, E. 1969. “Introduction: The Role of Systematics in Biology.” In *Systematic Biology: Proceedings of an International Conference*. National Academy of Sciences: Washington, D.C. pp 4-16.
- Moneo, R. 1978. “On Typology.” *Oppositions*. MIT Press: The Institute for Architecture and Urban Studies. pp 23-45.

- Neuwirth, R. 2019. 'Centuries-old irrigation system shows how to manage scarce water', <https://www.nationalgeographic.com/environment/article/acequias>, accessed 17 May 2021.
- Pleijster, E. et al. 2014. *Dutch Dikes*. Amsterdam: Nai010 Publishers.
- Rosenberg, A. ed. 'Acequias of the Southwestern United States: Elements of Resilience in a Coupled Natural and Human System,' AGRICULTURAL EXPERIMENT STATION • RESEARCH REPORT 796 (New Mexico State University: College of Agricultural, Consumer and Environmental Sciences, 2020).
- Rossi-Mastracci, J. 2020. "Unknown Futures Las Vegas: Landscape Strategy, Design Typologies, and Design Speculation." Louisville, Kentucky: CELA. pp 165-175.
- Schneider, R. and Breedlove, R. n.d. "Fire Management Study Unit." Report, USDA Forest Service.
- Wallis, J. and Rahmann, H. (2016). *Landscape Architecture and Digital Technologies: Re-Conceptualizing Design and Making*. Routledge, Taylor & Francis Group.
- Watson, J. 2019. *Lo-TEK: Design by Radical Indigenism*. Cologne: Taschen.
- World Bank. 2021. "A Catalogue of Nature-Based Solutions for Urban Resilience." World Bank, Washington, DC. <https://openknowledge.worldbank.org/handle/10986/36507>
- World Overview of Conservation Approaches and Technologies (WOCAT). n.d. "Global Database on Sustainable Land Management." Retrieved from <https://qcat.wocat.net/en/wocat>
- Zeedyk, W. et. al. 2009. *Let the Water Do the Work: Induced Meandering, an Evolving Method for Restoring Incised Channels*. Santa Fe, NM: Quivira Coalition.

Architectural Epidemiology: Introducing a Transdisciplinary Field of Study and Practice Using Real Estate as a Mechanism for Epidemiological Interventions on Climate Change & Chronic Disease

Adele Houghton¹, Carlos Castillo-Salgado²

¹Biositu, LLC and Harvard T.H. Chan School of Public Health, Boston, MA

²Johns Hopkins Bloomberg School of Public Health, Baltimore, MD

ABSTRACT: Problem Definition: The explosion of green and healthy building construction – 15 billion square feet since 2000 – stands in stark contrast with the lackluster performance of climate change and chronic disease metrics like building-related climate emissions, heart disease, and obesity. Seen through the lens of the social ecological model, this performance gap reflects a misalignment between real estate development teams (who work at the organizational level and focus on the needs of the site and its occupants), urban planners (who focus on the neighborhood and community levels), and local policy makers (who work at the public policy level and may not distinguish between the unique environmental health needs of each neighborhood in their jurisdiction). Method of Investigation: Architectural epidemiology is proposed as a transdisciplinary field of study and practice straddling the fields of architecture and public health. A subset of environmental and social epidemiology, it studies and applies real estate interventions as a pathway for environmental exposure and behavior change. Research Findings: Architectural epidemiology shows promise as an approach to design and operations that could contribute to reducing the risk of poor health outcomes and promoting positive health outcomes across multiple geographic scales (from the micro-environment surrounding the building site to the community level and beyond) and over different time scales (from tracking LEED credits during the design process to long term efforts to integrate health into all policies). Conclusion: We propose a new field called architectural epidemiology that will apply site-specific, scalable metrics to conversations around building design, renovation, and operations. It helps bring the organizational, community, and public policy levels of built environment interventions into alignment, so that a small number of coordinated design and operations interventions can catalyze neighborhood and community health action on climate change and chronic disease.

KEYWORDS: Architecture, Epidemiology, Climate Change, Chronic Disease, Social Determinants of Health

INTRODUCTION

A growing body of research shows the myriad ways that building design and operations influence the health of occupants and the surrounding community (Dannenberg, Frumkin, and Jackson 2011). Every time a new building is constructed or an existing building is renovated, it changes its surroundings in ways that can benefit or harm human health. Building projects increase or decrease impervious surface, changing population risk of injury or death from exposure to extreme heat and/or flooding. They draw new traffic or lead to reduced traffic congestion, changing population risk of respiratory and cardiovascular disease caused by exposure to ambient air pollution. They increase or decrease safe access to active infrastructure like sidewalks, protected bike lanes, and parks, changing the ability of building occupants and community members to be physically active, a risk factor for obesity, diabetes, and hypertension. Materials selection and mechanical system design increase or decrease occupant exposure to airborne contaminants – including environmental toxins that increase the risk of cancer and biological pathogens that can cause communicable diseases like COVID-19 and influenza.

Viewed in isolation, every building contributes to some portion of the environmental health status of its occupants and the surrounding neighborhood. But, when those individual building effects are aggregated to the scale of the built environment writ large, their influence on population health is massive – particularly in relation to the two most consequential public health challenges of the 21st century: climate change and chronic disease. The World Health Organization estimates that climate change will lead to 250,000 increased deaths annually from 2030 on from its contribution to malnutrition, malaria, diarrheal diseases, and heat stress alone (World Health Organization 2021). But, this number is a small proportion of the true health impact of climate change. A large and growing body of research has found strong direct and indirect health effects associated with a range of climate change-related exposures, including extreme heat, flooding, hurricanes/cyclones, air pollution, and vector-borne disease (Smith and Woodward 2014; Ebi et al. 2018). Chronic diseases both increase the risk of negative health outcomes related to climate change (Smith and Woodward 2014; Ebi et al. 2018) and represent the leading cause of death worldwide, accounting for close to 70% of total mortality – more than all other causes combined (World Health Organization 2014).

The built environment is a key factor in both of these public health challenges. According to the Global Alliance for Buildings and Construction, buildings are responsible for 40% of global greenhouse gas (GHG) emissions (Global Alliance for Buildings and Construction 2020). And, the World Health Organization estimates that the proportion of chronic disease attributable to environmental factors such as the built environment, exposure to pollution, physical exposure, and workplace exposure increased from 17% in 2002 to 22% in 2012 (Prüss-Ustün et al. 2017).

Over the past twenty years, the green and healthy building industry has galvanized the real estate sector to transform design, construction, and operations in the interest of reducing the industry’s environmental footprint and promoting health and wellness. The prevailing approach taken by both best practice toolkits and regulatory bodies around the world has been to streamline and quantify generic environmental and health metrics. Checklists demonstrate levels of compliance in a format that can be compared across individual buildings regardless of location or building type. Considering only process measures, this approach appears to have been a resounding success. Since 2000, 15.5 billion square feet of green and healthy buildings (U.S. Green Building Council 2019a; WELL Certified 2020) have been constructed globally (Figure 1). A glance at trends in desirable outcomes, on the other hand, tells a different story (Figure 1). Since 2010, global building-related emissions have increased 10% (Global Alliance for Buildings and Construction 2020), U.S. heart disease among adults has hovered between 10.5% and 11% (U.S. Centers for Disease Control and Prevention National Center for Health Statistics 2018), and the U.S. obesity rate among adults has risen from 27% to 31% (U.S. Centers for Disease Control and Prevention n.d.). Some green building best practice tools grant bonus points, such as LEED Regional Priority Credits (U.S. Green Building Council 2019b), to projects that achieve credits in their rating system that address high priority, local environmental issues. But, our research shows that these measures have not resulted in non-residential green building designs in the U.S. that are responsive to neighborhood environmental health needs. In fact, we found the opposite. A spatial analysis we performed on LEED for New Construction projects certified from 2001-2012 in Austin, TX and Chicago, IL found that, rather than clustering in high vulnerability neighborhoods, *low* vulnerability neighborhoods were more likely to see a concentration of LEED certified buildings with strategies protective in the face of extreme heat and flooding. In fact, LEED certified buildings were often absent altogether from high vulnerability areas (Houghton and Castillo-Salgado 2020). LEED in its current form has similarly fallen short in incentivizing active living measures that might result in lower risk of obesity, diabetes, and hypertension. For example, a case analysis comparing two LEED Certified affordable housing developments in New York City found that physical activity and obesity rates among occupants did not change in participants living in a LEED certified building. It required living in a building that achieved both LEED certification and a specific innovation credit (Design for Health through Increased Physical Activity) in order for researchers to see improvements in rates of physical activity and obesity metrics (Garland et al. 2018).

This paper proposes launching a new, transdisciplinary field called “architectural epidemiology” as one step towards redirecting built environment trend lines in the direction of human and planetary health. The theory underpinning architectural epidemiology is built on the hypothesis that reorienting design and operations to consider the building *in its context* will facilitate the coordination necessary for individual building projects to catalyze tangible action on community health priorities like climate change and chronic disease.

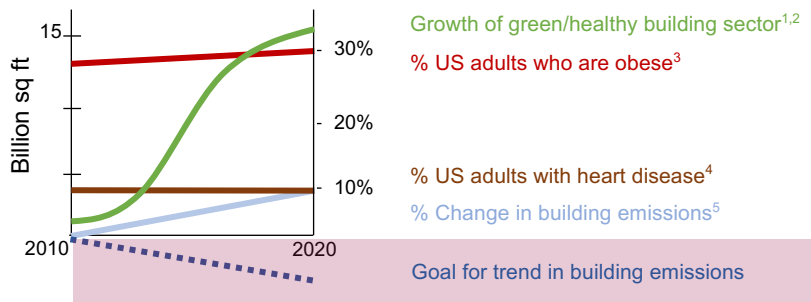

Figure 1: Green Building Trends and Related Emission and Health Trends, 2010-2020

Citations:

1. U.S. Green Building Council. (U.S. Green Building Council 2019a)
2. WELL Certified. (WELL Certified 2020)
3. U.S. CDC. (U.S. Centers for Disease Control and Prevention n.d.)
4. U.S. CDC. (U.S. Centers for Disease Control and Prevention National Center for Health Statistics 2018)
5. Global Alliance for Buildings and Construction. (Global Alliance for Buildings and Construction 2020)

1.0 PROBLEM DEFINITION

To understand how architectural design and operations can mediate environmental exposure on the one hand, and amplify public health interventions on the other, it can be helpful to consider how theories and frameworks used in social epidemiology help explain the ways in which human behavior influences population health outcomes.

1.1. Health Impact Pyramid

The health impact pyramid (Frieden 2010) was proposed in 2010 by Dr. Thomas Frieden, a former director of the U.S. Centers for Disease Control and Prevention (CDC), as an organizational structure for public health interventions (Figure 2). Frieden argues that the interventions with the largest societal impacts reside at the bottom of the pyramid (green in the figure), and the interventions requiring the most individual effort (depicted in red) sit at the top. Changes to the built environment fall in the second tier from the bottom. Design's position near the base of the pyramid signals that all new buildings, renovations, and decisions around facility operations have an effect on population health, whether the designer intends them to or not. The bottom tier of the pyramid describes socioeconomic and demographic factors, which place some groups within society at an advantage and others at a disadvantage in terms of accessing social services, safe living and working conditions, and a health-promoting environment that can reduce their risk profile for certain diseases. Policies governing land use and development that have exacerbated historical disparities in socioeconomic and health status include redlining (the historical practice of designating majority African American neighborhoods as ineligible to receive home mortgages) (Schuetz 2020), disinvestment in low income and minority neighborhoods (Brinkman and Lin 2019), and using the interstate highway construction process to fragment African American neighborhoods (Brinkman and Lin 2019).



Figure 2: Health Impact Pyramid with Building-specific Examples
Adapted from: Frieden TR. A framework for public health action: the health impact pyramid. *Am J Public Health*. 2010;100(4):590–5.

1.2. Social Ecological Model

If the health impact pyramid illustrates “what” aspects of public health are influenced by building design, the social ecological model (Figure 3) explains “why” the current system governing real estate development falls short of benefiting population health to the degree that would be expected from its position near the bottom of the pyramid. The social ecological model is based on the assumption that the way individuals and populations interact with their social and environmental context changes depending on the scale (or, “level”) of the interaction (Sallis and Owen 2015). Stakeholder engagement in the real estate development process changes from one level to the next – with very little communication across levels. Community members (whose activities start at the individual level) experience material changes to their neighborhood when a building is built or renovated. Real estate development teams (who work at the organizational level) approach development projects as interchangeable across their business portfolio. The local planning/zoning department (which operates at the community level) evaluates development proposals within the context of how a project will contribute to improving the economic prospects and quality of life of community residents. And, local policymakers (who work at the public policy level) view the development industry from the perspective of how it contributes to campaign pledges, such as creating jobs and meeting the Paris Climate Agreement. Architectural epidemiology uses scalable metrics to reorient stakeholders at all levels of the social ecological model towards creating shared value. By using common metrics to coordinate design and operations priorities across levels, approaching a project from the perspective of architectural epidemiology helps each stakeholder see how their goals align with stakeholders working at different levels in the social ecological model.

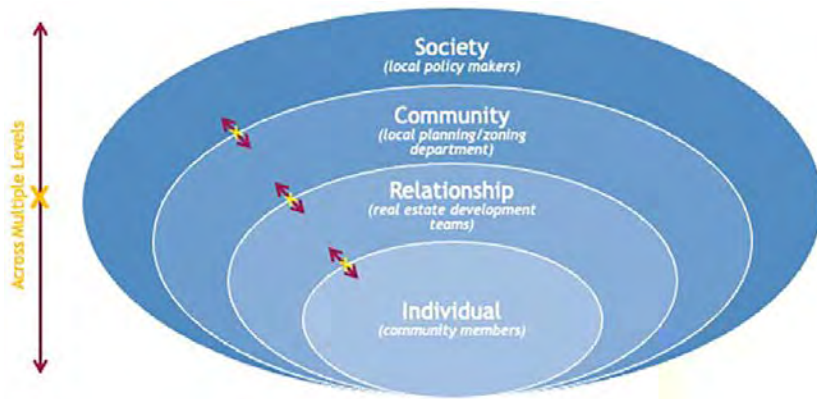

Figure 3: Social Ecological Model with Real Estate Examples
Adapted from: U.S. ATSDR Principles of Community Engagement. 2nd Ed. 2011. Available at: <https://www.atsdr.cdc.gov>

1.3. Relationship with Environmental and Social Epidemiology

Epidemiology is a field of study and practice that seeks to understand and shift the distribution of health-related conditions within a population (Porta 2014, 95). Its goal is to reduce the risk of poor health outcomes and promote positive health and wellbeing across a designated population. Architectural epidemiology draws from two subfields within epidemiology – environmental epidemiology and social epidemiology – to explain the relationship between environmental hazards, environmental exposures, health outcomes, and mediating factors like the social determinants of health and built environment interventions. Table 1 displays definitions of the key epidemiological terms that form its building blocks. It is important to note that, like the overall field of epidemiology, architectural epidemiology addresses population health risk, not the health outcome of any single individual.

Architectural epidemiology intersects with environmental epidemiology, in that it identifies and quantifies environmental exposures that could be mediated through design. It also uses path analysis, which is commonly deployed in environmental epidemiological studies. While its target of interest is environmental, it uses architecture and allied disciplines in the real estate industry as the mechanism for epidemiological interventions. As a result, it relies on social epidemiological theories like social determinants of health (Schulz and Northridge 2004; World Health Organization 2007), political ecology of health (Birn, Pillay, and Holtz 2017), and ecosocial theory (Krieger 1994) to propose changing behavior patterns in the real estate development process.

Table 1: Architectural Epidemiology in Context, Definitions

Term	Definition
Epidemiology	"[t]he study of the occurrence and distribution of health-related events, states, and processes in specified populations, including the study of the determinants influencing such processes, and the application of this knowledge to control relevant health problems." (Porta 2014, 95)
Environmental Epidemiology	"A branch or subspecialty of epidemiology that uses epidemiological principles, reasoning, and methods to study and control the health effects on populations of physical, chemical, and biological processes and agents external to the human body (e.g., climate change, air pollution, dietary pollutants, urbanization, energy production and combustion). Recognition of health hazards posed by large-scale environmental and ecological changes added extra dimension to the field." (Porta 2014, 93)
Social Epidemiology	"A branch or subspecialty of epidemiology that studies the role of social structures, processes, and factors in the production of health and disease in populations. It uses epidemiological knowledge, reasoning, and methods to study why and how the distribution of health states is influenced by factors as ethnicity, socioeconomic status and position, social class, or environmental and housing conditions." (Porta 2014, 264)
Social Determinants of Health	"The social determinants of health (SDH) are the non-medical factors that influence health outcomes. They are the conditions in which people are born, grow, work, live, and age, and the wider set of forces and systems shaping the conditions of daily life. These forces and systems include economic policies and systems, development agendas, social norms, social policies and political systems." (World Health Organization n.d.)
Path Analysis	"A method of analysis that emphasizes the sequencing and directionality of the associations between variables, or steps in a sequenced procedure. These are displayed in flow charts or path diagrams. When several alternatives are compared, a critical path analysis (review) can determine which is most credible and efficient." (Last 2007, 280)
Behavior Change	"A coordinated set of activities designed to modify a behavior to produce a desired outcome." (Porta 2014, 19)

2.0 METHODS – ARCHITECTURAL EPIDEMIOLOGY IN PRACTICE

2.1. Architectural Epidemiology Conceptual Diagram

The architectural epidemiology conceptual diagram in Figure 4 demonstrates how real estate development and facility operations can mediate the relationship between environmental exposures and population health outcomes. It follows the social determinants of health approach (Schulz and Northridge 2004; World Health Organization 2007) to

defining environmental hazards and exposures specific to the building site in question. Those exposures manifest through built environment determinants of health. For example, people on and around a building site may experience a number of environmental exposures related to climate change, including: air pollution, utility outages, urban heat island, and sea level rise. Depending on the existing built environment on and around the site, those exposures manifest in different ways. For example, the land use design might not include sidewalks or parks. Or, the site might be located in a flood plain. All of these considerations reflect environmental epidemiological questions of what environmental hazards are relevant to the site, what people on and around the site are exposed to, and how the baseline built environment contributes to exposure or protects the population from exposure. The social epidemiological lens considers the socioeconomic and political forces that have led to an inequitable distribution of environmental hazards throughout the community. It identifies and considers the historical reasons why some neighborhoods experience higher levels of harmful exposures and lower levels of health-promoting exposures (clean air, clean water, healthy food, and infrastructure promoting an active lifestyle). And, it includes an assessment of disparities in the spatial distribution of socioeconomic and demographic status in the neighborhood and community where the project is located. Those spatial disparities feed into the assessment of what health issues should be considered in the design, given the relationship between the built environmental determinants of health and the socioeconomic and physiological vulnerability on and around the site. Finally, for architectural epidemiology, the design and development mediating factors are the pathway for interventions that attempt to reduce negative environmental exposures and increase positive exposures, particularly among high risks populations. The ultimate goal is for design and development interventions to help shift the distribution of health outcomes towards increased equity and a reduction in overall relevant negative health outcomes. The scope of health outcomes influenced by real estate development could range from small scale (such as benefiting the micro-environment surrounding the building site) to community scale (such as contributing to achievement of the local climate action plan or obesity reduction plan) to national scale (such as contributing to the Neighborhood and Built Environment objectives in the U.S. Department of Health and Human Services Healthy People 2030 Framework (U.S. Department of Health and Human Services n.d.)). While many applications of architectural epidemiology will prioritize metrics that can be tracked immediately during the design process, it could also contribute to long term policy goals, such as the effort to integrate population health considerations into all policy decisions (the so-called Health in All Policies initiative (World Health Organization and Ministry of Social Affairs and Health Finland 2014)).

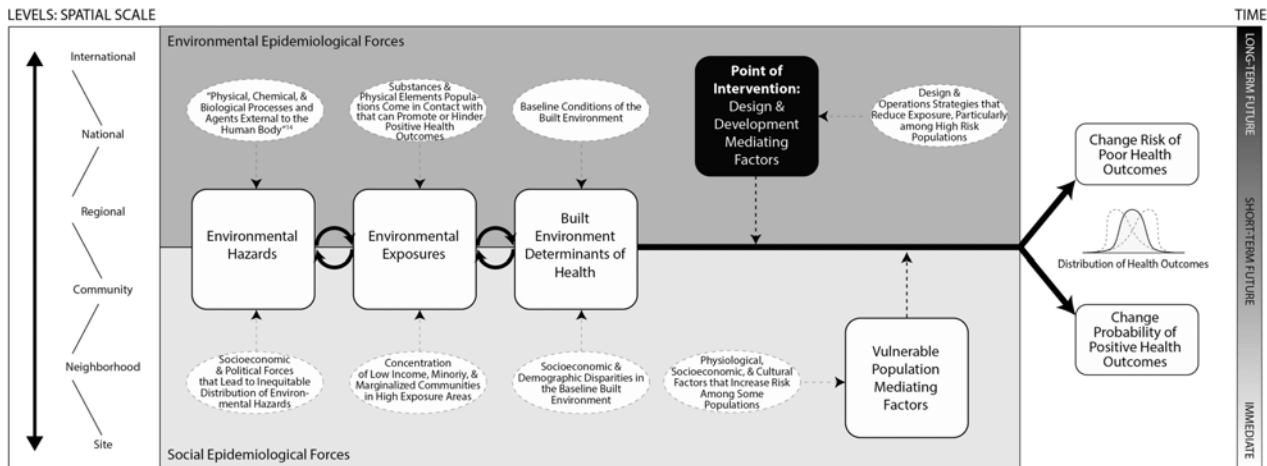

Figure 4: Architectural Epidemiology Conceptual Diagram
Adapted from (Birn, Pillay, and Holtz 2017; Krieger 2008; Schulz and Northridge 2004; World Health Organization 2007)

2.2 Twin Cities Case Study

Like other epidemiological fields of study, architectural epidemiology is designed to be applied on real projects, as illustrated in the following case study of three housing developments along a 4-mile light rail corridor linking Saint Paul and Minneapolis, MN. It is important to note that architectural epidemiology can be applied to any building type. In fact, our ecological study in Austin, TX, and Chicago, IL, described above considered a wide array of commercial and institutional buildings (Houghton and Castillo-Salgado 2020). We use the Twin Cities case study to illustrate how architectural epidemiology can reveal important variation among environmental health concerns and related design and operations recommendations across small geographic areas in response to changes in environmental exposures and population health needs. Table 2 shares summary information about the project type, location, and project phase of the three real estate developments included in the case study. Table 3 shows the similarities and differences in demographic, socioeconomic, and environmental health risk factors which resulted in different priority health outcomes and different design and operations recommendations for each development along the light rail corridor. Additional information about the case study is available in the project report (Houghton 2014).

Table 2: Twin Cities Case Study, Summary Information of Three Real Estate Developments

Project Type	Location	Project Phase
Mixed Income, Mixed-Use Development – with a low-income, single mother housing component	Southwestern quadrant of the Hamline-Midway neighborhood	Visioning
Single Family Retrofit	Center of the Frogtown neighborhood	Construction
Affordable Housing Mixed-Use Development – incorporating community development services targeted to neighborhood residents	Northeastern quadrant of the Summit-University neighborhood	Late Design Development

Source: Houghton, Adele. *Central Corridor Workshop: Using Health Data as a Design Tool*. 2014. (Houghton 2014)

Table 3: Environmental Public Health Indicators, Twin Cities Case Study

Demographic and Socioeconomic Risk Factors		
Categories	Priority Health Outcomes (<i>Relevant Neighborhoods</i>)	Metric Definition
Low Socioeconomic Status	Injury (F, SU), Heat (F, SU)	Population living in poverty
Race/Ethnicity	Cancer (F, SU), Heart Disease/Stroke (F, SU)	Percent non-White population
Age	Injury (HM), CLRD (F), Heat (F, SU), Vector-borne (F)	Percent population by age category
Environmental Health Risk Factors		
Nursing home population	CLRD (SU), Heat (SU)	Number of nursing home beds
Traffic-related air pollution	Cancer (HM, SU), CLRD (HM, SU)	Residential population within 300m of busy roadway
Access to fresh, healthy food	Cancer (HM), Heart Disease/Stroke (HM)	Percent population living within walking distance (1 mile) of a grocery store
Poorly maintained housing	CLRD (F), Heat (F), Vector-borne (F)	Number of “blighted” housing units by location
Exposure to environmental toxins in nearby industrial area	Cancer (HM)	Number of contaminated sites by location
Impervious surface/ Urban heat island	Heat (HM, F, SU)	Percent impervious surface
Lack of access to a private car	Injury (F, SU)	Percent of population with zero vehicles
Unsafe sidewalks and intersections	Injury (HM, F, SU)	Number of vehicle/pedestrian and vehicle/bicycle crashes annually by location

Annotations: HM: Hamline-Midway; F: Frogtown; SU: Summit-University

Source: Houghton, Adele. *Central Corridor Workshop: Using Health Data as a Design Tool*. 2014. (Houghton 2014)

Table 4: Top Five Design and Operations Recommendations, Twin Cities Case Study

Hamline-Midway	Frogtown	Summit-University
1. Provide safe and accessible pathways onto and through the property for alternative forms of transportation (e.g., pedestrians, cyclists, etc.).	1. Design the kitchen/dining space to encourage preparation of fresh foods.	1. Discourage jaywalking by funneling site access for pedestrians and cyclists to street intersections.
2. Provide bicycle storage and showers and host a Nice Ride station (the local bike share program).	2. Install landscaping that prioritizes shading the house, deterring mosquitoes, and cultivating edible plants.	2. Designate the property as smoke-free or provide a dedicated outdoor space for smoking.
3. Right size parking to encourage alternative transportation.	3. Remove asthma triggers from the interior, such as: carpet, off gassing materials, deteriorated building envelope, etc.	3. Locate doors, windows, and outdoor air intakes away from pollution sources.
4. Include a pocket park as part of the development design to mitigate the urban heat island effect.	4. Make sure all sources of mold have been removed from existing building materials and are not reintroduced by new assemblies such as fiberglass batt insulation.	4. Plant vegetation to screen the development from pollution sources, such as major roads.
5. Host recreation programs for all ages (including mother/baby programs) that provide an opportunity for physical activity and social cohesion.	5. Focus energy efficiency measures on the roof and attic to reduce solar heat gain during summer months. (Example strategies: light colored or vegetative roof, increased attic insulation, etc.)	5. Host on-site farmers markets, a community garden, and/or a CSA drop-off site.

Source: Houghton, Adele. *Central Corridor Workshop: Using Health Data as a Design Tool*. 2014. (Houghton 2014)

3.0 DISCUSSION

The Twin Cities case study exemplifies several contributions the proposed new field of architectural epidemiology could offer to both the research and practice of real estate development and facilities operations.

First and foremost, it proposes rooting the question of “what defines a healthy building” in that building’s social and environmental context. Neither building codes nor green/healthy building rating systems are currently equipped to guide project teams towards prioritizing the strategies that will be most effective at improving environmental health conditions on and around the project site. The goal of architectural epidemiology is to make visible the environmental

health needs on and around building sites, so that project teams are equipped to make strategic design and operations decisions. The variety in both priority health outcomes and recommended strategies over such a small geographic area exemplifies the gap in research and practice that architectural epidemiology is attempting to fill.

Second, architectural epidemiology offers an approach to translating public health methods to the design field. This contribution has the potential to open up new areas of research and fill longstanding gaps in understanding about the relationship between individual design/operations strategies, pathways to environmental exposure, and associated health outcomes. It builds on a rich history in epidemiological research that estimates outcomes based on observational data. Key to this approach are the assumptions that all epidemiological estimates assess population risk (not the risk to an individual) and that any attempt to estimate the relationship between an environmental exposure and a specific health outcome will only describe a piece of a larger picture. This is because it is not possible to randomly place study participants across a landscape (i.e., approximate a randomized control trial). And, it is also difficult or impossible to isolate a single causal pathway between an environmental exposure and a specific health outcome. The previous assumption could also be seen as a limitation. One way to overcome concerns about causal relationships is to focus on the relative magnitude of different pathways in the project's conceptual model.

A more significant limitation to the current nascent field of architectural epidemiology is the small number of projects where it has been performed (less than 10 as of this publication). The approach should be replicated, validated, and refined across multiple geographies and building types, so that it can grow into a robust field of research and practice. A final limitation is the dearth of primary research quantifying the relative health benefits of specific building design and operations strategies to specific health outcomes. This research is fundamental to growing a body of evidence that can be used by project teams to translate their conceptual frameworks and metrics into design recommendations.

4.0 CONCLUSION

This paper proposes a new, transdisciplinary field of research and practice called architectural epidemiology, which proposes using building design and operations as a mediating factor to alter the relationship between environmental hazards and health outcomes. Specifically, it draws on theories of environmental and social epidemiology to prioritize the environmental and population health needs on and around a proposed building project. And, it lays out an approach to translating that analysis into evidence-based design and operations recommendations that can be tracked using metrics tied to green and healthy building rating systems and/or community key performance indicators related to climate change and chronic disease. The motivation for launching this new field is to address the research and market failures that stand in the way of building design and operations' contributing to local action on public health crises like climate change and chronic disease.

REFERENCES

- Birn, Anne-Emanuelle, Yogan Pillay, and Timothy H. Holtz. 2017. "Health and the Environment." In *Textbook of Global Health*. Oxford, UK: Oxford University Press. DOI: 10.1093/acprof:oso/9780199392285.001.0001.
- Brinkman, Jeffrey, and Jeffrey Lin. 2019. "Freeway Revolts!" WP 19-29. Philadelphia, PA: Federal Reserve Bank of Philadelphia. <https://www.philadelphiafed.org/-/media/frbp/assets/working-papers/2019/wp19-29.pdf?la=en>.
- Dannenberg, Andrew L., Howard Frumkin, and Richard J. Jackson, eds. 2011. *Making Healthy Places: Designing and Building for Health, Well-Being, and Sustainability*. Washington, D.C.: Island Press. <http://islandpress.org/ip/books/book/islandpress/M/bo8062628.html>.
- Ebi, K.L., J.M. Balbus, G. Lubet, A. Bole, A. Crimmins, G. Glass, S. Saha, M.M. Shimamoto, J. Trtanj, and J.L. White-Newsome. 2018. "Human Health." In *Impacts, Risks, and Adaptation in the United States: Fourth National Climate Assessment*, edited by D.R. Reidmiller, C.W. Avery, D.R. Easterling, K.E. Kunkel, K.L.M. Lewis, T.K. Maycock, and B.C. Stewart, Volume 2:572–603. Washington, D.C.: U.S. Global Change Research Program. <https://nca2018.globalchange.gov>.
- Frieden, Thomas R. 2010. "A Framework for Public Health Action: The Health Impact Pyramid." *American Journal of Public Health* 100 (4): 590–95. <https://doi.org/10.2105/AJPH.2009.185652>.
- Garland, Elizabeth, Victoria Garland, Dominique Peters, John Doucette, Erin Thanik, Sritha Rajupet, and Sadie H. Sanchez. 2018. "Active Design in Affordable Housing: A Public Health Nudge." *Preventive Medicine Reports* 10: 9–14. <https://doi.org/10.1016/j.pmedr.2018.01.015>.
- Global Alliance for Buildings and Construction. 2020. "2020 Global Status Report for Buildings and Construction: Towards a Zero-Emission, Efficient, and Resilient Buildings and Construction Sector." International Energy Agency, United Nations Environment Programme. <https://www.worldgbc.org/news-media/launch-2020-global-status-report-buildings-and-construction>.
- Houghton, Adele. 2014. "Central Corridor Workshop: Using Health Data as a Design Tool." Prepared for the Minnesota Pollution Control Agency. <http://biositu.com/documents/MPCA-Central%20Corridor%20Workshop-Using%20Health%20Data%20as%20a%20Design%20Tool-2014.pdf>.
- Houghton, Adele, and Carlos Castillo-Salgado. 2020. "Analysis of Correlations Between Neighborhood-Level Vulnerability to Climate Change and Protective Green Building Design Strategies: A Spatial and Ecological Analysis." *Building and Environment* 168: 106523. <https://doi.org/10.1016/j.buildenv.2019.106523>.

- Krieger, Nancy. 1994. "Epidemiology and the Web of Causation: Has Anyone Seen the Spider?" *Social Science & Medicine* 39 (7): 887–903. [https://doi.org/10.1016/0277-9536\(94\)90202-X](https://doi.org/10.1016/0277-9536(94)90202-X).
- . 2008. "Proximal, Distal, and the Politics of Causation: What's Level Got to Do with It?" *American Journal of Public Health* 98 (2): 221–30. <https://doi.org/10.2105/AJPH.2007.111278>.
- Last, John M. 2007. *A Dictionary of Public Health*. New York, U.S.A.: Oxford University Press.
- Porta, Miquel, ed. 2014. *A Dictionary of Epidemiology*. 6th Edition. Oxford, UK: Oxford University Press.
- Prüss-Ustün, A, J Wolf, C Corvalán, T Neville, R Bos, and M Neira. 2017. "Diseases Due to Unhealthy Environments: An Updated Estimate of the Global Burden of Disease Attributable to Environmental Determinants of Health." *Journal of Public Health* 39 (3): 464–75. <https://doi.org/10.1093/pubmed/fdw085>.
- Sallis, James F., and Neville Owen. 2015. "Ch. 3: Ecological Models of Health Behavior." In *Health Behavior: Theory, Research, Practice*, edited by Karen Glanz, Barbara K. Rimer, and K. Viswanath, 5th Ed., 43–64. San Francisco, CA: Jossey-Bass.
- Schuetz, Jenny. 2020. "Rethinking Homeownership Incentives to Improve Household Financial Security and Shrink the Racial Wealth Gap." Brookings Blueprints for American Renewal and Prosperity. Washington, D.C.: Brookings Institution. <https://www.brookings.edu/research/rethinking-homeownership-incentives-to-improve-household-financial-security-and-shrink-the-racial-wealth-gap/>.
- Schulz, Amy, and Mary E Northridge. 2004. "Social Determinants of Health: Implications for Environmental Health Promotion." *Health Education & Behavior* 31 (4): 455–71. <https://doi.org/10.1177/1090198104265598>.
- Smith, Kirk R., and Alistair Woodward. 2014. "Human Health: Impacts, Adaptation, and Co-Benefits." In *Climate Change 2014: Impacts, Adaptation, and Vulnerability. Contribution of Working Group II to the Fifth Assessment Report of the Intergovernmental Panel on Climate Change*, Final Draft. Intergovernmental Panel on Climate Change Working Group II. <http://www.ipcc.ch/report/ar5/wg2/>.
- U.S. Centers for Disease Control and Prevention. n.d. "Nutrition, Physical Activity, and Obesity: Data, Trends and Maps." Accessed January 20, 2021. <https://www.cdc.gov/nccdphp/dnpao/data-trends-maps/index.html>.
- U.S. Centers for Disease Control and Prevention National Center for Health Statistics. 2018. "Table 13. Respondent-Reported Prevalence of Heart Disease, Cancer, and Stroke among Adults Aged 18 and over, by Selected Characteristics: United States, Average Annual, Selected Years 1997–1998 through 2016–2017." In *Health, United States, 2018 – Data Finder*. https://www.cdc.gov/nchs/hus/contents2018.htm?search=Heart_disease.
- U.S. Department of Health and Human Services. n.d. "Healthy People 2030." Accessed January 17, 2022. <https://health.gov/healthypeople>.
- U.S. Green Building Council. 2019a. "LEED." <https://new.usgbc.org/articles/about-lead>.
- . 2019b. "Regional Priority Credit Lookup." LEED - Getting Started. 2019. <https://www.usgbc.org/rpc>.
- WELL Certified. 2020. "WELL Hits Major Global Milestone Supporting Healthier People and Better Buildings." February 5, 2020. <https://resources.wellcertified.com/press-releases/well-hits-major-global-milestone-supporting-healthier-people-and-better-buildings/>.
- World Health Organization. 2007. "A Conceptual Framework for Action on the Social Determinants of Health," no. April: 77–77. http://www.who.int/social_determinants/resources/csdh_framework_action_05_07.pdf.
- . 2014. "Global Status Report on Noncommunicable Diseases: 2014." Geneva, Switzerland. https://apps.who.int/iris/bitstream/handle/10665/148114/9789241564854_eng.pdf;jsessionid=8A2DE6D35FD565CFADBE9998C81DA16A?sequence=1.
- . 2021. "Climate Change and Health." <https://www.who.int/news-room/fact-sheets/detail/climate-change-and-health>.
- . n.d. "Social Determinants of Health." Health Topics. Accessed January 17, 2022. https://www.who.int/health-topics/social-determinants-of-health#tab=tab_1.
- World Health Organization, and Ministry of Social Affairs and Health Finland. 2014. "Health in All Policies: Helsinki Statement Framework for Country Action." https://apps.who.int/iris/bitstream/handle/10665/112636/9789241506908_eng.pdf;jsessionid=FF9DC65B6CF4D4B6C50C4E19F1CC8C36?sequence=1.

ACKNOWLEDGEMENTS

The authors wish to acknowledge the Minnesota Pollution Control Agency, which sponsored the Central Corridor Workshop, whose results are referenced in the text. A portion of the contents of this paper will be published in a book entitled *Architectural Epidemiology*, scheduled for publication in 2023.

Advanced Modular Housing Design for Highly Efficient, Affordable, and Resilient Post-Disaster Housing

Forough Foroutan Jahromi¹, Jeffrey Carney¹

¹University of Florida, Gainesville, FL

ABSTRACT: More frequent and intense hurricanes cause increased coastal erosion, more flood damage to housing, and undermine community infrastructure. The combined environmental, urban, and individual toll of such risks has a broad impact on the wellbeing of communities. This paper focuses on the architectural design contribution to a multi-disciplinary research project funded by the Department of Housing and Urban Development (HUD) that investigates the design of a new type of advanced modular housing to provide rapid recovery, reliable efficient energy, and long-term adaptability to homes located in areas facing increased flooding risk. This study developed and tested a design of modular homes that could supply and deliver shelters quickly after a disaster, that would contribute to the long-term resilience of the community, and could become a community asset over time. The study resulted in the development of a design concept that our team titled “Core+”. It is a combination of three distinct modular units that leads to a wide variety of design configurations based on the user’s requirements up to full deployment as a 1,200sf 3-bedroom/2-bath home. The Core+ is deployed in the immediate aftermath of a disaster to provide minimal shelter immediately and, as components are added, to remain on-site as an affordable and high-efficiency home. The research team included individuals with expertise in Architectural design, Building Energy Design, Life Cycle Economics, and Affordability. Three design charettes gathered input from local architects and manufacturers to inform the Core+ design. The design was further refined through a community workshop in hurricane-damaged North Port St. Joe, FL which revealed design challenges and opportunities for improvement through stakeholder feedback.

KEYWORDS: Modular housing, Manufactured housing, Post-disaster housing, Resilience, Affordability, Energy efficiency

1.0. INTRODUCTION

Climate change consequences, and related disasters are increasing significantly, which are the most likely cause of housing disruption and displacement for hundreds of thousands of people in the United States (Wamsler 2010). Many communities are currently dealing with the arduous challenge of rebuilding after major storms have severely damaged or destroyed them. Hurricanes are the most common natural disaster in the United States (Types of Disasters, 2021) and are expected to become more powerful and frequent, particularly in coastal areas, making this risk more difficult to resolve (Jagger et al. 2008). In the wake of many natural disasters such as tropical cyclones, and flooding that have destroyed human habitats worldwide, post-disaster housing is critical.

A valuable option to the post-disaster housing challenge is manufactured modular housing that can be produced with higher quality, precision, safety, speed (Gunawardena et al. 2014), affordability (Thompson 2019), sustainability, and more inherent resilience than its site-built counterparts. Manufacturing modular housing in factories indicates a significant move away from building housing on construction sites, and it presently houses more than 22 million low-income Americans (Sullivan 2017; HUDUSER 2020).

Previous studies have suggested various advantages of modular housing manufacturing through the fabrication process (Gibb and Pendlebury 2006) including a more consistent rate of production (Pan, Gibb, and Dainty 2012), higher level of quality control (“Design in Modular Construction” 2021), improved safety performance (“HTA Design LLP - Apex House” 2021), greater consistency and accuracy in production and, more opportunities for leveraging automation technology (Gibb 1999). Kedir and Hall suggest that manufactured housing is a potential resource saver with innovative construction techniques and products (Kedir and Hall 2021) and Obando mentioned that manufactured housing can be considered as an important source of affordable housing, particularly for rural and low-income residents (Obando 2019). Moreover, Housing issues in a post-disaster context are more than just a matter of expediency. It is critical to comprehend the true complexities of community concerns. Post-disaster housing and reconstruction solutions should address significant difficulties such as affordability through the development of efficient financial strategies, sustainability through energy efficiency and material durability, and long-term commitment to communities through design for resilience (Johnson and Lizarralde, 2012).

Government agencies provide post-disaster shelters for affected individuals in post-disaster situations. The Federal Emergency Management Agency (FEMA) assists individuals before, during, and after catastrophes. (FEMA, 2021). It provides financial aid to homeowners for repairs or replacement of damaged residences by providing RVs or trailers as temporary shelters, temporary housing units, hotel rooms, and short-term condo rentals. (El-Anwar, 2013; FEMA, 2021). Aside from FEMA, local government institutions such as the Florida State Government's Division of Emergency Management and the Florida Building Code assist in disaster preparation and recovery before and after the disaster. However, based on this research, the government primarily provides temporary housing and mobile units after hurricanes. While long-term and long-distance displacement expose a gray area between immediate shelter and permanent housing, along with concerns about vulnerability, housing availability, and land development (Levin et al. 1998) there was no significant evidence of successful government efforts for rapid provision of permanent housing (El-Anwar, 2013; Hamideh et al., 2021). Despite this, numerous private companies create hurricane-resistant homes in a variety of sizes and price ranges to endure heavy winds and, in some cases, Category 5 disasters.

Due to the challenge of immediately supplying large quantities of post-disaster housing, the larger study examined how the modular home manufacturing industry can contribute to finding solutions. The following are the two research questions that the larger study and following that the architectural design section responded::

- How do we design and build modular housing that helps minimize the effects of climate change while also lowering operational costs via various sustainability approaches?
- In the face of increasingly frequent and significant natural disasters, how can we provide people with affordable housing and enable them to become more resilient to disturbances at the same time?

Research conducted for the study was aimed at collaborating with the modular housing manufacturing industry through an active dialogue throughout the design process to create a roadmap to use cutting-edge technologies in the design of post-disaster housing. This project employed three overlapping research methods using case study research, design charrettes, and a multi-disciplinary research team. The Advanced Modular Housing Design (AMHD) as a method of conducting this investigation, focused on the design and development of housing that can be quickly constructed in factories to facilitate the transition from on-site fabrication to manufactured modular housing.

This paper reports on the architectural design process of the larger study to develop Core+. The paper proceeds as follows. First, we outline the methodology used to explore the stated research questions. Next, we discuss the underlying objectives AMHD is pursuing. The energy efficiency, affordability, and life cycle cost findings of the larger project are then summarized. Following this, we draw on the understanding of the concept of the Core+ design as well as the assembly process and options This paper will contribute to a greater understanding of the potential for permanent post-disaster housing.

2.0 METHODOLOGY

The architecture section that led to this article was inspired by the wider study project, which used a mixed methodology containing three overlapping, complementary, and consecutive research techniques. Firstly, a series of manufactured modular housing projects were documented and assessed, with the responsiveness, sustainability, and equity of the response being examined as well. The findings of case studies served as the foundation for a partnership of researchers and manufacturing professionals in the field of manufactured modular housing. Secondly, to address all the project's targeted aspects with competence, the research project defines research teams including expertise in Architecture, Building Energy Design, Life Cycle Economics, and Affordability. Finally, Design Charrettes provided an opportunity to gather individuals of diverse expertise and apply that expertise to the design. As part of the project, three charrettes each with a thematic focus were held.

The first charrette focused on understanding the demographics and geographic conditions where the AMHD is designed to function. Considering the fact that the user of the AMHD is more than simply the person or family who occupies the structure, but can be influenced by the site, the conditions of occupation, and tenure duration, through the second charrette, the AMHD was exposed to a variety of user needs, in a number of scenario exercises with the mortgage and lending experts, architects, builders, and manufacturers. Each scenario contained a location, description of site and lot condition, family status, land tenure, and demographic. Participants were asked to solve the problem based on various scenarios, which led to a more accurate assessment of the efficacy of other options and refinement of the AMHD. The third charrette brought technologists, energy efficiency experts, fabricators together to incorporate new technologies. The participants raised critical points of consideration and specific questions that needed to be answered during the charrette, such as material selection, installation techniques, and energy performance, which led to the AMHD's next phase.

The final charrette was held as a workshop in North Port St. Joe (NPSJ), FL partnership with the University of Florida Resilient Cities Program, the Florida A&M University Architecture School, and the North Port St. Joe Project Area Coalition (PAC). The workshop, following a few years after Hurricane Michael, provided opportunities for the AMHD to develop actionable ideas and inputs from a careful hearing and understanding of community members' concerns. The

direct feedback helped to identify the modular housing design options that meet community needs for housing that is affordable, rapidly constructed, resilient and energy-efficient. In this workshop, the AMHD was able to use the Core+ model to design, specify, and price homes for six sites suggested by community members. It was also important to work with NPSJ clients to fit the home to their space needs, site conditions, and budgets which results in refining the design. It was also an important goal for the team to coordinate with the City to ensure that the homes meet all local zoning and building codes and also working with external funders, including HUD, to determine a future for the Core+ model in North Port St. Joe or similar towns.

The design development in the workshop started with a conversation with community members as potential clients to understand their needs. Six potential sites were suggested by the community members. The design team evaluated the flood zone and other site conditions and then developed specific plans shaped by the Core+ for each of the six sites. Each site had different orientations and specifications, and the owner's requirements were modeled to estimate cost and energy consumption.

3.0 DEVELOPING THE CONCEPT OF “CORE+”

3.1 AMHD Research

The AMHD focuses on providing housing in response to the situation in the southeast U.S. in climate zones 1 through 3 where the bulk of the impacts from hurricanes are being felt. The AMH Design process follows its goal by pursuing three concurrent research goals: resource, efficiency, and resilience, which provide design objectives as well as a set of evaluation metrics to assess the AMHD's performance in comparison to other designs. Each theme is reflective of the expertise of the architecture team including housing design and construction, passive energy systems, and building and community resilience. The AMHD project's goals have been shaped through the process of material selection, structural durability, passive energy design strategies, and resilience attitude. The result of the AMHD, which is a modular affordable sustainable home, will be placed on new sites and will rapidly provide replacement housing damaged or destroyed by any of the environmental risks

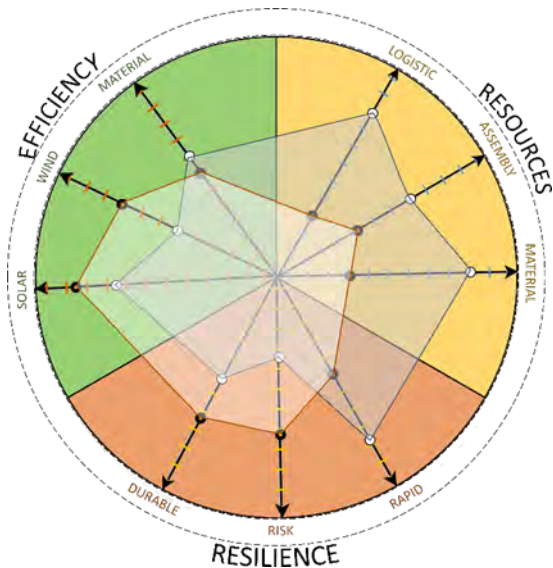

Figure 1: Three research aims with measurable objectives that are balanced through the AMHD design process. Source: (Author 2021)

The AMHD establishes a balance between the values of mass production and mass customization, decreasing unit prices, improving quality, and shortening project duration (Larsen et al. 2019), while meeting the primary goal of delivering resilient, efficient, and affordable post-disaster housing. Whenever large portions of existing housing stock are damaged, labor shortages, permitting delays, and building material backlogs can significantly slow the process of resettling displaced residents. (Yau, Tsai, and Nurma Yulita 2014). Disaster recovery can be lengthy, especially for homeowners and renters with low incomes. (Hamideh, Peacock, and Zandt 2021). Debris removal, regulations, permitting, government funds, loan disbursements, and labor shortages all contribute to this long process which can cause tremendous stress, loss of jobs, bankruptcy, and homelessness, particularly for lower-income homeowners and tenants (Paidakaki and Parra 2018).

Mass-fabricated or modular housing, in which significant portions of the house are prefabricated in factories, reduces labor costs and enables sufficient housing to be built in safer environments before being shipped to those suffering damage (Gunawardena et al. 2014). By utilizing mass fabrication technologies, AMHD maximizes efficiency. There are various drawbacks associated with mass fabrication, such as regional and microclimatic conditions, siting requirements, coastal flood risks, client preferences, budget constraints, financing options, and local building regulations. Additionally, the inevitable adaptations that change families and neighborhoods over time need to be considered. Individual adjustments will allow the AMHD design to adapt to the specific requirements of the consumers, site, and budget. This compromise, often known as mass customization, provides for both manufacturing benefits and individual preferences.

3.2. Inputs from other Research Teams

As indicated before, as a part of the methodology, four specialist teams have been selected and worked on various aspects of AMHD. The design process and the output of the AMHD, the Core+, were inspired by the other teams, either directly or indirectly. The building system energy team specified and analyzed three sets of building energy models for evaluating the energy use of Core+, based on the assumption that proper building design could reduce the amount of building energy use. The most energy-efficient model chosen was based on the International Energy Conservation Code, or IECC-2018, and included solar water heating as well as a 15% reduction in equipment energy usage, resulting in a 33.8 percent energy savings over the other models studied. As a result, the building envelope, which includes walls, roofs, and windows, was effectively selected to reduce the overall energy use of Core+, and it positively influenced the design.

Additionally, the affordability studies underlined the fact that the creation of a hyper-efficient house will address a major issue that low-income homeowners are facing. Also, the team suggests that in comparison to the expensive single-family houses, prefabricated housing is an inexpensive owning option which by using the AMHD approach could also be considered as an investment to the individuals who have been severely affected economically by the disaster (Shimberg Center for Housing Studies 2020).

Based on the scope of the project and designing for the southeast U.S. with climate zone 1,2 and, 3, which is mainly affected by hurricane, the life cycle economics team chose two geographically different zones including Gainesville, FL, and Charlestown, SC, respectively located in climate zones 2 and 3 to predict energy consumption. The energy simulation model for each city was developed with the BEopt software tool with the addition of the initial construction costs, the simple payback time, and the life cycle expenses over a 60-year period. As a result, the design process and the Core+ model were improved making long-term decisions about material selection and design strategies.

3.3. Core+ and the Design Exploration

The end result is a modular home with a factory-based manufacturing procedures to form three housing units: CORE, SPACE, and DWELL. These three modules may be integrated in a variety of ways to develop a range of home shapes, and they can be assembled according to a buyer's specific location, budget, time schedule, and family requirements. Each Core+ module plays a unique function in the supply of affordable long-term housing following a disaster.

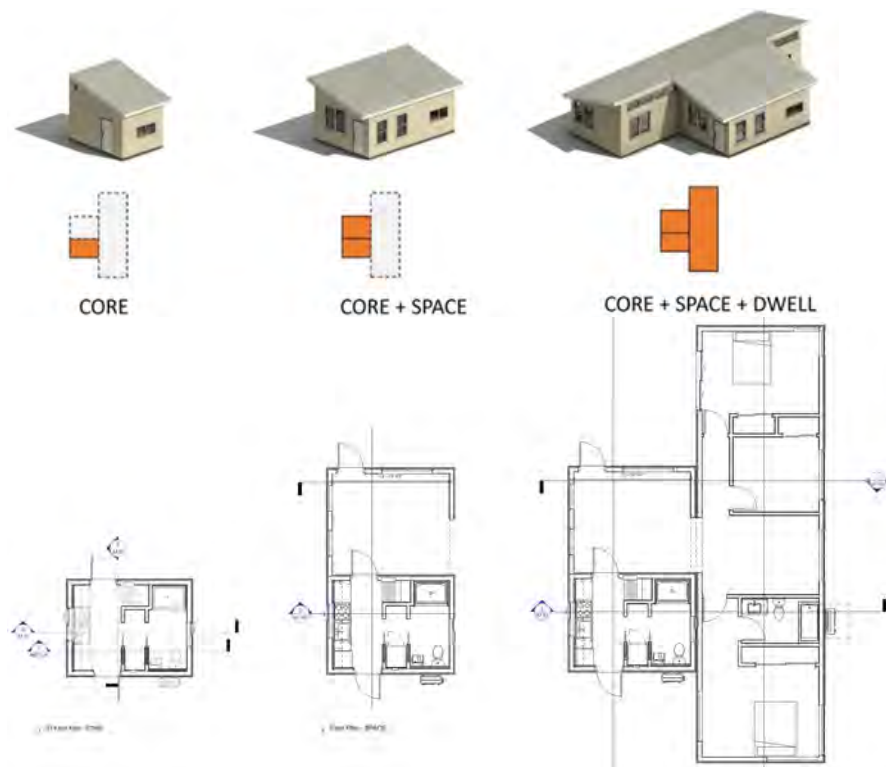

Figure 2: Distinct modules that accomplish three core functions of housing: CORE+SPACE+DWELL. Source: (Author 2021)

CORE would be supplied to the catastrophe location within days. If the property isn't ready yet, it might be temporarily housed in a parking lot or another area. The unit, as shown in figure 2, is the whole structure's substantial, storm-resistant "heart," offering key dwelling services such as a kitchen, bath, laundry, and sleeping loft. The Core's construction is structurally robust, and it will give optimal protection to occupants during future storms. This would enable deployment to high-risk locations like the Florida Keys. CORE is a rigid (self-supporting) and hardened structure that provides storm resistance and foundation flexibility, even to the point where it may be temporarily constructed and anchored. The CORE is a light gauge metal frame with sheathing and closed-cell foam insulation, built in a rigid assembly and delivered volumetrically for rapid installation.

SPACE is the second additional module, which offers a versatile area that may be used as a den, sleeping porch, or a complete bedroom. It's built to be adaptable, with homeowners encouraged to add on to and modify the structure to meet their individual needs. This unit can be deployed with the CORE unit or added later to provide additional space. It is semi-rigid, needing extra foundation support.

DWELL is the last of the three modular components. It maximizes the modular structure's size with the addition of three bedrooms, and an additional bathroom. As a result of its traditional scaling for chasis transportation, it keeps the costs of the unit down while allowing for a 1200 SF of living space. Because dwell is the most significant component of the residence, it has a greater influence on the entire cost.

3.4. Core+ Assembly Process

The importance of disaster recovery has been discussed and led many authors to identify different stages for it (Alexander 2018; Lindell 2013; M. Sullivan 2003). Lindell argues that it is more helpful to consider disaster recovery in terms of four functions including disaster assessment, short-term recovery, long-term reconstruction, and recovery management (Lindell 2013).

Housing recovery is a process with several phases rather than merely a single outcome (Sutley and Hamideh 2020). The Core+ considers four integrated generalized stages that home occupants go through to rebuild in disaster recovery. The first stage is the site assessment which includes the initial evaluation of the damages. Following a disaster, there is a period of site evaluation done by FEMA, local emergency management, and insurance companies to determine the extent of damage, the levels of compensation that insurance will provide, and the authority to rebuild and to what extent. Many jurisdictions are implementing pre-disaster plans that are moving disaster-prone sites out of circulation as they are increasingly vulnerable. The AMHD project does not deal specifically with this process, but this provides the essential legal and financial groundwork for the next phases.

The second stage would concentrate on rebuilding choices and financing possibilities by working with a manufacturer or builder and a financial institution to select and fund a new house. This is where the AMHD process concentrates its efforts. "Select, Site, and Balance" are the three primary processes that the team has added to this stage. (See Figure 3). Each one acts as an interface between the house buyer and the structure's construction. User-generated feedback at each phase gives upfront, monthly, and lifespan cost alternatives, allowing the user to choose the Core+ assembly that best suits their site, family, and finance needs.

The third stage is building or installation, which is designed through a number of distinct building phases to get residents back into their homes as soon as feasible after a disaster. Starting with the post-disaster deployment of a CORE unit, when a unit is installed on a preliminarily cleared location perhaps just weeks after a disaster. After this preliminary phase, a more traditional site preparation phase with utilities and concrete/block foundations can commence. The modular units are easy to install, however, because they can be delivered over time, simple techniques for unit mating have been incorporated.

Building adaptation is the final stage, which implies that as families and communities expand and change, the home adapts and allows for some flexibility. Resilience is also incorporated into this concept by the way the house is designed to adjust over time. The adaptability of the design has been emphasized so that inhabitants may alter their homes overtime to meet their unique demands. As part of the balancing process, adjustments are chosen that adapt the mass-produced shell to meet the needs of a community, the environment, or the building owner. Trellis, decks, carports, and window coverings are some of the elements that we can add. The assembly can be adapted to different locations and demands, and the construction can also be changed. The project also forecasts how the community's strengths and weaknesses will develop over time by assessing how communities responded to previous disasters in order to prepare for future threats. The AMHD has taken into account the concept of time in this way, allowing purchasers to intervene depending on future anticipated requests.

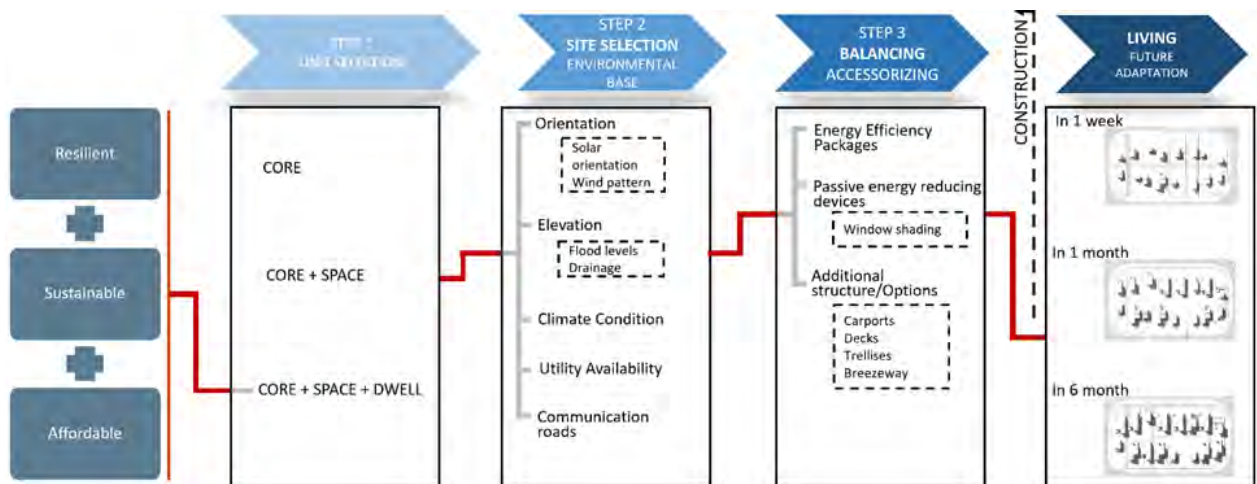

Figure 3: Assembly steps: Select, Site, Balance. Source: (Author 2021)

3.4.1. Rebuild Choice

Throughout the assembling procedure, the reconstruction choice stage consists of three steps that will assist the customer in selecting the Core+ assembly that best suits their site, family, and financial needs. The first step, as shown in Figure 3, is unit selection, which lets the customer choose the amount of units and delivery timeline that they want. This step would determine the unit's base pricing. The selection of a location would be the next step. Because the Core+ is designed for disaster recovery, the precise locations for which the home is being built are subject to a range of hazards. Orientation, height above the ground, local solar exposure, and other aspects play a role in determining where a structure should be placed. This step will change the unit's basic pricing and add a monthly utility cost estimate. The third step is balancing, which allows owners to fine-tune the design of the unit by installing passive energy-saving devices such as window shades and adding additional structure such as carports, decks, and trellises, which will further adjust the Core+'s base and monthly costs and allow the model to work with a variety of financial frameworks.

4.0 LIMITATIONS

After the development of Core+ there are still substantial questions for further research, design, and public policy that remain to be addressed before projects like this can be fully deployed. Based on the discussions with expertise in manufacturing through charrette 2, the ability to manufacture Core+ at high speed is key to its success. Manufacturing large quantities of post-disaster homes prior to an event has been difficult because of the uncertainty of the location of the disaster, the severity of the event, and the availability of storage space. Additionally, once manufactured, modular

home components must be maintained while in storage, creating additional costs. Another obstacle is the availability of capital for manufacturing post-disaster homes and the speculative nature of such an investment. Furthermore, transportation of the units to the crisis zone, particularly because of the pandemic's impact, is a factor to consider.

For Core+ the strategy is the appropriate government agencies to collaborate with the modular home manufacturing industry on several fronts. First, the industry must modernize its factories and adopt automation and information technologies that allow factories to be scalable from normal production rates up to the high production rates needed for manufacturing Core+ which reduces the need for the storage space. This industry needs government investment to modernize their factories both to produce affordable housing and to be prepared to ramp up manufacturing to produce large quantities of post-disaster Core+ modules (Design Charrette 2020).

Second, the contractual instruments required for the factories to initiate and finance the manufacturing process must be developed. This also presumes that technical information about Core+ must be disseminated to the industry so that when a disaster occurs, the factories have the technical and financial ability to manufacture and deliver the modules. Third, communities need a standard process to plan post-disaster communities to be executed after a natural disaster. There remain many questions regarding how to proceed with the creation of post-disaster communities. For example, the roles of the insurance companies, the local government, and U.S. government agencies must be clarified via a consensus process. It is clearly very important that this occurs prior to the disasters occurring and it is likely that this entire scheme should be tested in a region that has a high likelihood of experiencing powerful storms.

5.0 CONCLUSION

The solution that AMHD propose for addressing this challenge is advanced technologies and process improvements that support the design and manufacturing of resilient, sustainable, and affordable post-disaster housing. The Core+ modules have been designed to create homes that are rapidly constructed after a disaster and provide substantial efficiencies and greater levels of long-term resilience. The materials, structure, and foundations of Core+ are designed to be storm and flood-resistant.

The resilience design of this project also considers that following a disaster, it will be critical for structures to be rebuilt quickly so that families may return in a matter of weeks rather than years. It is also recognized that a house, whether manufactured or not, is an investment that may have long-term worth and contribute to the long-term value of a community with the ability to grow and adapt. The Core+ was designed not just to grow utilizing the components chosen, but also to grow long after the initial purchase. As shown in Figure 4, it allows the user to stamp their own identity on their dwellings while they are living in them. The Core+ improves results for low-income groups by including resident input through an incremental housing approach.

Furthermore, rather than serving solely as temporary housing for a disaster-affected community, the idea is that these homes would be used to replace severely damaged houses and serve as the foundation of a resilient community following the disaster or any other housing disruption. This home will combine modular and manufactured housing techniques as well as introduce new approaches in order to provide rapidly installed, adaptable yet permanent homes.



Figure 4: Core+ view adding a breezeway inbetween the units with other design modifications after years of unit installation and adapting by means of AMHD design capacity resulted from the community workshop. Source: (Author 2021)

ACKNOWLEDGEMENTS

The larger research project was funded by the U.S. Department of Housing and Urban Development (HUD) and completed at the University of Florida with collaborative teams of university researchers.

REFERENCES

- Alexander, David. 2018. *Natural Disasters*. London: Routledge. <https://doi.org/10.4324/9781315859149>.
- "Design in Modular Construction." 2021. Routledge & CRC Press. Accessed September 17, 2021. <https://www.routledge.com/Design-in-Modular-Construction/Lawson-Ogden-Goodier/p/book/9780367865351>.
- Design Charrette 2020. The charrette met at a Zoom Meeting room with participants from HUD, industry experts university faculties and student. It was held at February 2nd 2020 with the goal of digging into the overall objectives of the CORE+ concept and how it can be improved to achieve through the design.
- Gibb, Alistair G. F. 1999. *Off-Site Fabrication: Prefabrication, Pre-Assembly and Modularisation*. 1st edition. New York etc.: Wiley.
- Gibb, Alister, and Martyn Pendlebury, eds. 2006. "Buildoffsite Glossary of Terms (2nd Edition)," *Construction Industry Research & Information Association (CIRIA)*, 38.
- Gunawardena, Tharaka, Tuan Ngo, Priyan Mendis, Lu Aye, and Robert Crawford. 2014. "Time-Efficient Post-Disaster Housing Reconstruction with Prefabricated Modular Structures." *Open House International* 39 (3): 59–69.
- Hamideh, Sara, Walter Gillis Peacock, and Shannon Van Zandt. 2021. "Housing Type Matters for Pace of Recovery: Evidence from Hurricane Ike." *International Journal of Disaster Risk Reduction* 57 (April): 102149. <https://doi.org/10.1016/j.ijdr.2021.102149>.
- "HTA Design LLP - Apex House." 2021. Accessed September 17, 2021. <https://www.offsitehub.co.uk/projects/apex-house-by-hta-design-llp/>.
- HUDUSER. 2020. "Factory-Built Housing for Affordability, Efficiency, and Resilience | HUD USER." 2020. <https://www.huduser.gov/portal/periodicals/em/WinterSpring20/highlight1.html>.
- Jagger, Thomas H., James B. Elsner, Mark, and A. Saunders. 2008. "Forecasting U.S. Insured Hurricane Losses." In *Climate Extremes and Society*, Edited By, 189–206. University Press.
- Johnson, C., and G. Lizarralde. 2012 "Post-Disaster Housing and Reconstruction." *International Encyclopedia of Housing and Home*, 340–46.
- Kedir, Firehiwot, and Daniel M. Hall. 2021. "Resource Efficiency in Industrialized Housing Construction – A Systematic Review of Current Performance and Future Opportunities." *Journal of Cleaner Production* 286 (March): 125443. <https://doi.org/10.1016/j.jclepro.2020.125443>.
- Larsen, Maria Stoettrup Schioenning, Søren Munch Lindhard, Thomas Ditlev Brunoe, Kjeld Nielsen, and Jesper Kranker Larsen. 2019. "Mass Customization in the House Building Industry: Literature Review and Research Directions." *Frontiers in Built Environment* 5: 115. <https://doi.org/10.3389/fbuil.2019.00115>.
- Levin, Simon A., Scott Barrett, Sara Aniyar, William Baumol, Christopher Bliss, Bert Bolin, Partha Dasgupta, et al. 1998. "Resilience in Natural and Socioeconomic Systems." *Environment and Development Economics* 3 (2): 221–62. <https://doi.org/10.1017/S1355770X98240125>.
- Lindell, Michael. 2013. "Recovery and Reconstruction After Disaster." In *Encyclopedia of Earth Sciences Series*, 812–24. https://doi.org/10.1007/978-1-4020-4399-4_285.
- Obando, Sebastian. 2019. "'Mom-and-Pop' Manufactured Home Communities Might Be the Next Frontier for Investment in the Sector." *National Real Estate Investor*, March. <https://www.proquest.com/docview/2190933092/abstract/7A46FD566AC0441EPQ/1>.
- "Offsite Construction : Research." n.d. Accessed September 17, 2021. <https://offsite.lboro.ac.uk/proj-glossary.php>.
- Paidakaki, Angeliki, and Constanza Parra. 2018. "'Housing for All' at the Era of Financialization; Can (Post-Disaster) Cities Become Truly Socially Resilient and Egalitarian?" *Local Environment* 23 (10): 1023–40. <https://doi.org/10.1080/13549839.2018.1518416>.
- Pan, Wei, Alistair Gibb, and Andrew Dainty. 2012. "Strategies for Integrating the Use of Off-Site Production Technologies in House Building," January. [https://doi.org/10.1061/\(ASCE\)CO.1943-7862.0000544](https://doi.org/10.1061/(ASCE)CO.1943-7862.0000544)].
- Shimberg Center for Housing Studies. 2020. "Florida Housing Data Clearinghouse." 2020. <http://flhousingdata.shimberg.ufl.edu/>.
- Sullivan, Esther. 2017. "Displaced in Place: Manufactured Housing, Mass Eviction, and the Paradox of State Intervention." *American Sociological Review* 82 (2): 243–69. <https://doi.org/10.1177/0003122416688667>.
- Sullivan, Mark. 2003. "Integrated Recovery Management: A New Way of Looking at a Delicate Process." *The Australian Journal of Emergency Management* 18 (2): 4–27. <https://doi.org/10.3316/ielapa.281649714561982>.
- Sutley, Elaina J., and Sara Hamideh. 2020. "Postdisaster Housing Stages: A Markov Chain Approach to Model Sequences and Duration Based on Social Vulnerability." *Risk Analysis* 40 (12): 2675–95. <https://doi.org/10.1111/risa.13576>.
- Thompson, John. 2019. "Modular Construction: A Solution to Affordable Housing Challenges," April. <https://ecommons.cornell.edu/handle/1813/70841>.
- U.S. Energy Information Administration (EIA). 2020. "Annual Energy Outlook 2020 with Projections to 2050." 2020. <https://www.eia.gov/index.php>.
- Wamsler, Christine. 2010. "REDUCING RISK IN A CHANGING CLIMATE: Changing Paradigms toward Urban Pro-Poor Adaptation." *Open House International* 35 (1): 6–25.
- Yau, Nie-Jia, Ming-Kuan Tsai, and Eryani Nurma Yulita. 2014. "Improving Efficiency for Post-Disaster Transitional Housing in Indonesia: An Exploratory Case Study." *Disaster Prevention and Management* 23 (2): 157–74. <https://doi.org/10.1108/DPM-04-2013-0071>.

A Proposed Evaluation Tool for the Resiliency of Post-Disaster Housing: A Case Study of a Post-Earthquake and Tsunami Social Housing Development in the Coast of Southern Chile

Daniela Scheuermann Pino¹, Andrea Martínez Arias¹, María Isabel Rivera Barraza^{1,2}

¹Facultad de Arquitectura, Urbanismo y Geografía, Universidad de Concepción, Chile

²Researcher, Centre for Sustainable Urban Development (CEDEUS), Chile

ABSTRACT: Chile is constantly affected by various natural disasters of great magnitude and intensity, mainly affecting the country's coastal areas through successive earthquakes and tsunamis recorded throughout history. Chile still holds the record for the strongest and most devastating earthquake of the 20th-century, instrumentally documented having a magnitude of 9.5 in Valdivia in 1960. That is why different government initiatives have been developed to reconstruct and protect the coastline, promoting a resilient and sustainable reconstruction in the future. Regarding government initiatives, resiliency is a concept that has recently started to be included at a policy level. In this way, tools for evaluating resiliency are mainly observed at a macro level, from an urban perspective of the territory and urban planning, but little focus has been put into a more micro-scale towards basic post-disaster facilities, such as housing. This research proposes a tool for assessing the level of resilience of post-disaster homes located in Chile's coastal areas. A matrix with the first set of indicators was developed to evaluate a diagnosis around the concept of resilience. The proposed matrix is inspired and conceived from one of the existing comprehensive models of urban resiliency as the City Resilience Framework from the Rockefeller Foundation (2015). The study explores suitable criteria and measurable indicators for assessing resilience capacities at a building scale. However, the case study shows that post-disaster buildings that have been implemented still need to consider multiple risks with a more holistic approach. This area of research will continue to be fundamental due to constant hazards as a result of Chile's geographical condition.

KEYWORDS: Resilient Housing, Disaster Risk, Tsunami, Global Sustainability: Mitigation and Adaptation, Coastal Cities: Design Frameworks for Interconnectivity.

INTRODUCTION

As our century runs, the concept of resiliency is more common when referring to risks in increasingly populated cities. In particular, many risks driven by climate change have focused on populations in coastal areas. Coastal cities have a reservoir of historical stresses or sudden shocks that often result in physical collapse, economic deprivation, or social stress, nowadays exacerbated by a global pandemic. Furedi (2007) states that disasters have had various explanations for much of human history based on the causes of these phenomena, such as acts of God or nature (Furedi, 2007); while Wisner (2004) stresses that it is fundamental to understand that exposure and vulnerability reveal that disasters are built (Wisner, 2004). Those stressors related to post-disaster recovery capacity or resistance to natural hazard events stand out among them.

The concept of resilience is by no means a new concept, which sees a resurgence in reducing vulnerability, and its evocation is generally negative. As a term, resilience emerged from the field of ecology in the 1970s to describe the capacity of a system to maintain or recover functionality in the event of disruption or disturbance. For Jabareen (2013), resilience is the capacity by an urban/social system as a neighborhood or city to efficiently and quickly recover to resist, absorb, adapt or recover from the effects of threats, which includes recovering their basic structures and functions (Jabareen, 2013, 221). For some authors, resilience finds its origins in engineering fields and has moved to the social sciences, adding to the list of adjectives describing today's cities. Henderson and Milstein (2003) refer to resilience as overcoming stress, trauma, and risk. From the perspective of systems, it mainly refers to enhancing performance in the face of multiple hazards rather than preventing or mitigating the loss of assets due to specific events (The Rockefeller Foundation and ARUP 2015, 3). Despite its complexity and versatility, resilience is seen as a positive aspect and a capacity that should be developed (Henderson and Milstein, 2003).

Currently, various international initiatives make it possible to measure and evaluate the existing resilience in cities. The United Nations for Disaster Risk Reduction (UNDRR) campaign "Making Cities Resilience" (UNDRR, 2010) is a simple tool that seeks to promote the creation of resilience in cities by raising awareness among local governments. On the

other hand, the Rockefeller Foundation's "Resilient Cities Framework" campaign (2015) aims to establish basic guidelines on the qualities of resilient systems. Currently, the UNDRR (2017) has developed a resilience measurement plan called "Self-assessment tool for resilience against disasters at the local level," allowing two types of evaluation, one preliminary and the other in-depth, of the resilience present in the cities.

For coastal countries like Chile, the uniqueness of its geographical position requires an integration of resilience, which has recently been embraced. Extreme natural events are part of the country's history due mainly to physical-natural characteristics. These risks affect the territory in different intensities and magnitude (Brignardello, 2007). The Chilean Government, announced the approval of a national policy for 2030 for disaster risk reduction (in Spanish, Política Nacional para la Reducción del Riesgo de Desastres - PNRRDD). The latter follows the international commitments acquired by the Chilean Government towards establishing a guiding framework that strengthens disaster risk management in the country by 2030 (PNRRD, 2021). In this direction, resilience is considered a capacity to integrate an interactive process between communities and their vital or social environment (Política Nacional para la Reducción del Riesgo de Desastres, 2021, p.6). Where to live is a complex existential phenomenon, and in our national territory, it is usually linked to multiple threats (Saldarriaga, 2002, 30).

For countries where resiliency is starting to be considered in building and rebuilding cities, existing capabilities to respond to risk must be reinforced, or, instead, they must be created. From the international initiatives, we observe the existence of mechanisms for evaluation of resilience approached from an urban scale (macro-scale); however, there have been fewer initiatives that address this measurement from a building scale (micro-scale). Those capabilities are to be distributed between Government agencies and private organizations, which together would effectively reduce the impacts from threats. To comply with the above initiatives, it is appropriate for Governments and responsible agencies to integrate the resilience capacity into urban planning processes and instruments, from the macro to the micro-scale in architectural design. This is particularly important, to evaluate and inform about the resilience of housing developments in risk areas, which is unfortunately common in Chile.

1.0 METHODOLOGY

1.1 Objectives

This study's main objective is to propose a resilience measurement tool oriented to assess the level of resiliency in post-disaster housing. Building this resilience evaluation matrix entailed two specific objectives: 1) Proposing a resilience evaluation matrix including the main qualities of a resilient house, also incorporating the instances that would characterize the different qualities previously established. 2) Testing the proposed matrix on a case study. The matrix was built following the steps shown in Figure 1.

For the development and planning of the proposed tool, a theoretical-practical strategy was used, structured in two phases that respond to the specific objectives, aiming to design a resilience measurement model focused on post-disaster housing. The methodological approach was developed through the literature review obtained from the referential framework and the subsequent construction of a resilience measurement instrument. The analysis of the existing models for measuring resilience was crucial for identifying a suitable reference model that allows developing the general frame of the evaluation matrix– the indicators derived from this review, mainly in the form of existing building codes.

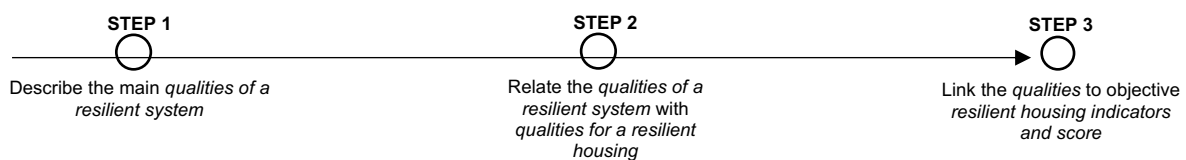

Figure 1: Steps in creating indicators for resilient housing. Source: Authors

1.2. Case Study

The proposed framework was tested on a post-disaster housing development on the coastal town of Dichato, in the southern Biobío region in Chile, built after the magnitude 8.8 earthquake on February 27, 2010, (27F from here on) and following a tsunami, illustrated in Figure 2. Dichato accounts for 4,850 people and 49.5 km², with a fluctuating population, especially during the summer tourism season. Geographically, it is a closed bay with a U shape and calm and cold waters. It is mainly characterized by water sports, its gastronomic and fishing trade, where a large part of the population works in the fishing, algae harvesting, gastronomy, and hotel sectors.

Dichato was among the most affected towns, evidencing around 80% destruction of buildings, particularly homes located along the ocean's coastline, due to waves reaching about 6.5 meters high that entered up to 1,200 meters from the coast (PRBC, 2010, 12). Villa Horizonte was initially a temporary camp for post-disaster relief built by the government and local agencies. This site was the largest village affected in Chile post 27F, with around 210 displaced families. Each of these post-disaster houses has an area of 51 m² (550 sqft) (Radio Biobío, 2013).



Figure 2: Location map of Dichato, Región del Biobío (left). Aerial view of Dichato (right-top) and area of study (right-bottom) built after earthquake and tsunamis of 2010 in Dichato Bay. Credits: Dichatochile, Google Earth (2021).

2.0 A PROPOSED RESILIENCE EVALUATION MATRIX FOR ARCHITECTURE SCALE

The proposed evaluation tool recognizes features existing on resilient systems in the existing literature. A review of the leading models for measuring resilience was done to identify characteristics of resilient systems. Understood as a complex system, resilience must fulfill and sustain core functions in the built environment. A city's functions rely on a combination of assets, systems, practices, and actions undertaken by multiple actors. A performance-based approach presents a more holistic and significant potential to address interdependency, power dynamics, and scale questions.

1.1 First Stage: Analyzing current models for measuring resilience

The formulation to determine the main features of a resilient system in a micro-scale was built based on the identified frameworks for a macro-scale, as three main milestones. First, the "Developing Resilient Cities" campaign by UNDRR in 2010 aimed to support sustainable urban development, promote resilience activities, and increase the understanding of risk at the local level. The model for assessing resilience revolved around three central themes: increasing knowledge, suitable investments, and safer constructions. Local governments that adhered to the campaign committed to direct the development of risk reduction activities through ten essential aspects established by the organization (UNDRR, 2010). Second, the "Resilient Cities Framework and Index" developed by the Rockefeller Foundation aimed to establish a baseline on seven critical functions of cities more resilient where the main *Qualities of Resilient Systems* are established: Flexible, Redundant, Robust, Resolute, Reflective, Inclusive and Comprehensive (The Rockefeller Foundation, 2015, p.9). As a third milestone, a plan called "Self-assessment tool for disaster resilience at the local level" was developed in 2017. This tool offers the possibility of evaluating resilience at two levels, one preliminary and the other at a detailed level. The first level establishes targets and indicators with some critical 47 questions. The second level includes 117 indicator criteria, each with a score of 0 to 5 (UNDRR, 2021).

1.2. Second Stage: Indicators for the Resilience evaluation matrix

The Rockefeller Foundation framework was used as the main framework for the proposed matrix, which interprets each of the features of resilient urban systems to a more micro-scale as a housing unit. This framework synthesizes seven qualities, translated to a set of indicators (**Error! Reference source not found.2**) that would allow analyzing, evaluating, and diagnosing those qualities in the proposed minor scale. For simplicity, one indicator has been identified for the post-disaster house under relevant risk of earthquake–tsunami. An evaluative table based on a 1 to 5 Likert Scale was established (Table 1), in which 1 = Not observed, 2 = Does not meet the established indicator, 3 = Attempts to meet the established indicator, 4 = Meets the established indicator, and 5 = Outstanding at meeting the established indicator. A diagnosis was developed based on the score ranges. A low score (ranging between 1 to 14 points) would correspond to a not-resilient house. A high score (between 28 to 35 points) would indicate a house development and solution with the highest performance regarding post-disaster resilience.

Table 1: Scoring levels of resilience. Based on single categories defined by potential scores in the Likert scale

Points	Diagnosis
1-14	Housing is substandard around Post-Disaster Resilience. *No learning is observed in the reconstruction process about the existing threats.
15-21	Housing generates some attempts for resilient measures but not enough. *Housing tries to generate some measures to mitigate risk resiliently.
22-27	The house partially complies with the indicators. *The home complies with 50% of the components of a resilient home.
28-31	The home complies with being a Post-Disaster Resilient home. *The house manages to be called Resilient.
32-35	Housing is outstanding in Post-Disaster Resilience. *Housing is an example to follow around Resilient strategies for DRR.

Table 2: Interpretation of the main qualities by The Rockefeller Foundation and the proposed indicators and proposed methods and scoring suited for each indicator. Source: the authors based on City Resilience Framework (Rockefeller Foundation and ARUP, 2015)

Qualities	Description	Interpretation	Indicator	Method	1	2	3	4	5
1. Reflective	Ability to continually evolve and modify standards around risk. This would be reflected in post-disaster learning for reconstruction.	A reflective home generates post-disaster analysis and learning. (For example, being outside a risk zone.)	1. Location of the home around the relevant Risk Map.	Map of flooding (SHOA)	<i>No data to evaluate</i>	<i>House is within the identified risk area</i>	<i>House is a temporary solution in the risk area</i>	<i>House is outside the risk area</i>	<i>House is outside the risk area by a distance higher than 500 m.</i>
2. Robust	Resistant construction. It refers to the capacity that can withstand the impacts of risks.	A robust home offers resistance against an eventual threat. For this, materiality is crucial at the moment of impact.	1. Materiality of the house. *1	Review of plans and construction specs Site visit	<i>No data to evaluate</i>	<i>Built out of wood, with values between 16-23 N/mm² at compression</i>			Built with a high-resistance material (concrete) value of 20-30 N/mm ²
3. Redundant	Capacity to reserve resources to prevent disaster, which allows the functionality of its essential services.	A redundant home can generate reserves of basic services by capturing rainwater or solar energy.	1. Reserve equipment for rainwater, electricity, solar energy, etc.	Review of plans and construction specs Site visit	<i>No data to evaluate</i>	Inexistence of a backup energy source	One backup source (electricity or water)	Water and electricity collection system	More than two backup systems
4. Flexible	Capacity associated with generating versatile spaces implies that systems can change, evolve, and adapt to changing circumstances.	A flexible home can offer versatility in its architecture program, transforming everyday spaces into protected areas and family and neighborhood organization. Observe for open groundfloor level that allows flexibility of use or reorganization	1. Floor plan of the dwelling and its relationship with the immediate surroundings.	Review of plans and construction specs Site visit	<i>No data to evaluate</i>	House does not have a flexible ground level		House does have a flexible ground level	House has more than one flexibility strategy
5. Decisive	The ingenuity of the home around eventual threats, such as different ways of meeting its needs during a disaster event.	A decisive home offers solutions around eventual threats.	1. Observation and respective planimetry of dwellings. Evaluate if their home has been designed for something like vertical evacuation.	Review of plans and construction specs Site visit	<i>No data to evaluate</i>	House does not allow vertical evacuation	House has a solution, but it is difficult to use	House has a resolution on that does allow vertical evacuation	House has more than one resolution that does allow vertical evacuation
6. Inclusive	Ability to accommodate the various needs for universal accessibility in the home.	An inclusive home understands the needs of all its members.	1. Code compliance for universal access and people participation. *2	Review of plans and construction specs Site visit		House does not have universal accessibility	House would allow minimum universal accessibility	House does have universal accessibility	House does have as many features for universal accessibility
7. Integral	Ability to connect with the immediate environment and proximity to its various emergency services.	An integral home is close to facilities, presenting proximity to emergency facilities such as hospitals, firefighters, police, etc.	1. Local ordinance and Communal Regulatory Plan or Site in Google Earth.	Local Municipal Code and urban regulations for essential services		The house is far from essential services (more than 1000 m)	The house is close (less than 800 m)	The house is close (less than 500 m)	The house is close (less than 300 m)

*1 The house complies with a resistant construction system associated with the forces created by the threat. (*based on Technological Center of Spain, 2011)

*2 The design allows universal accessibility. Observes compliance with Supreme Decree (DS) N°50 of the national ordinance (OGUC for its Spanish acronym)

*3 Aerial images from Google Earth or the Communal Regulatory Plan will be consulted for proximity to essential services.

3.0 RESULTS

The Villa Horizonte case study was evaluated around the qualities previously established in Table 1 and 2 and the scoring process detailed in **Error! Reference source not found.3**. According to the proposed evaluation matrix, Villa Horizonte resulted in 17 points out of the total 35 points, corresponding to a category that "partially complies with the indicators" associated with a post-disaster resilient home.

Table 3: Villa Horizonte's results are represented as star graphs and scores applying a 5-point Likert scale according to the matrix.

Qualities	Interpretation	1	2	3	4	5	
1. Reflective	Learning is observed in the location of the post-disaster housing.					5	
2. Robust	The house offers a physical resistance to risk.		2				
3. Redundant	The house offers spaces to reserve resources.		2				
4. Flexible	The house exposes a versatility of use in a disaster scenario.			3			
5. Decisive	Housing provides solutions when facing a risk.	1					
6. Inclusive	The house meets the needs of each resident.	1					
7. Integral	The house offers an integration with the immediate environment.			3			
Total							17/35 points

4.0 DISCUSSION

Our cities are a great living laboratory for learning. The reinforcement of resilience from a holistic perspective will allow us as a community to work with local and national governments to lead better solutions. The proposed matrix in this study is founded on the existing framework for resilience and advances towards providing a tool for resilience. It works toward better estimating the level of resilience embedded in designed solutions, or as a basic set of measurable indicators. Suppose the whole community of stakeholders, such as government officials, investors, policy-makers, and the community, better understand the resilience qualities and how much of those are in their buildings. In that case, we all would collectively foster more resilient cities. The proposed tool is a first step providing a structure with more measurable indicators. It lists a primary set of indicators, with the need to be complemented, reviewed, and refined over future research to assess if these housing developments are best placed to ensure people's safety, particularly the poor and vulnerable, to survive and thrive no matter what disaster or stress they encounter.

Regarding the case study, we can reaffirm what was stated by Brignardello (1997) that Chile is a country constantly affected by natural risks both in intensity and magnitude. Villa Horizonte was affected by the disaster of 27F and by mass removal and flooding presented after the reconstruction. The Villa Horizonte Case Study represents an extreme reconstruction case, as it was considered the largest relief camp village in all of Chile post 27F for 210 families affected by the disaster. In that sense, being such an iconic case of post-disaster reconstruction, it must stand as an example of the right solution in response to multiple risks (earthquake and tsunami). However, it failed to consider other latent risks such as flooding and mudslides in the new location (Figure 3). It highlights the relevance of integrating the concept of resilient housing into the reconstruction process. In this sense, integration of capabilities of stakeholders and understanding of resilience is fundamental since they would reduce the existing vulnerability and manage to internalize the risk in the design on a permanent location for the rebuilt efforts to be worth it.



Figure 3: Images of Villa Horizonte under floods and landslides in 2013 because of lack of retaining walls and rainwater collection. Credits: Soychile.cl, Tomé al día, (2015).

The final result shown by the evaluation matrix indicates a "partial" performance around the established qualities of resilience. If we highlight positive aspects of it, we can see that there was learning behind this reconstruction process,

where the relocation of the population was carried out outside the area of inundation by a tsunami, along with considering an area of future housing growth. On the other hand, within the negative aspects of the evaluation, we can declare that there is no inclusion of the community opinion of the sector in the housing design process, excluding an architectural resolution for people with reduced accessibility and other types of disabilities. Finally, although more than 210 families were given homes, the future threats that could be found in the sector, such as floods and landslides that occurred in 2015, were not foreseen.

The evaluation matrix developed in this research can be viewed as a draft or a first methodological basis, since we consider that for its entire operation, it is necessary to collect the public opinion of its inhabitants, an element that we could not collect during fieldwork due to the lengthy quarantines and restrictions throughout the country from the Covid-19 pandemic. This element would reveal the human and community factor present in post-disaster architecture about how communities face and gather skills such as resilience, and how to incorporate them into housing design. The proposed evaluation matrix can be applied from isolated elements (a single dwelling) to more complex elements such as condominiums or high-rise dwellings, like the ones analyzed in this case study. Let us not forget that this method aims to introduce and encourage the concept of resilience on a material scale (such as housing). Still, it would not work on its own since the human and community element must develop this capacity to apply it in the immediate environment and resist future changes and adversities (Walsh, 1998).

CONCLUSION

The study proposes an evaluation tool founded around the city-resiliency qualities from the Rockefeller Foundation. The established macro-scale parameters are fully applicable to a smaller scale approach such as a building scale. A proposed evaluation matrix compiles definitions for each quality and translates them into indicators, which were contextualized to methods and instances to assign scores and define resiliency levels. With multi-hazard scenarios, proposals have to consider all those risks. In this sense, it was considered pertinent to measure, evaluate, and integrate resilience in the post-disaster reconstruction process applied to a case study in Chile. For the Villa Horizonte, a housing development built after an 8.8 earthquake and tsunami, multi-hazards were not considered. As applied, the case study did not score as a resilient solution according to the proposed indicators. As many designs developed from a reaction perspective, this solution did not consider future risk based on location or other potential natural or man-made hazards.

The instrument developed in this research may be helpful as a first step to develop resilience measurement models for post-disaster housing. This way, it could meet the objectives established in the various initiatives around Disaster Risk Reduction, such as the Coastal Edge Reconstruction Plan (2010), the National Policy for Disaster Risk Reduction (2021), and future ones. We acknowledge that this is the first set of indicators included in the development of this tool and still needs further research and fine-tuning along with including other indicators through future studies. However, we see the importance of applying this methodology to other case studies to make the matrix more robust and applicable to other rebuilt sites in Chile. Finally, a call is made for more research on the concept of Resilient Housing, and it is expected that through this instrument, a simple methodological contribution will be generated, which will allow further investigation in the field.

ACKNOWLEDGEMENTS

This study was possible thanks to the support provided by the following people/institutions: Faculty of Architecture, Urbanism and Geography (FAUG) of the University of Concepción; government-funded research by ANID PAI-77180057 and CEDEUS, ANID/FONDAP 15110020.

REFERENCES

- Brignardello, L. 1997. *Proposición Metodológica Para la evaluación y zonificación integrada de riesgos naturales mediante la aplicación de Sistemas de Información Geográfica*. Revista Norte Grande N° 24. Instituto de Geografía, PUC, Chile, pp. 91-102
- Furedi F 2007 *Invitation to terror: the expanding empire of the unknown*. Continuum Press, London
- Henderson, N. y Milstein, M. 2003. *Resiliencia en la escuela*. Buenos Aires.
- Jabareen, Y. 2013. *Planning the resilient city: Concepts and strategies for coping with climate change and environmental risk*. *Cities*, 31(0), 220–229. doi:10.1016/j.cities.2012.05.004
- Municipalidad de Dichato 2010 Plan Regulador del Borde Costero de Dichato
- SoyChile. 2013. *Dichato: damnificados del terremoto sufrieron inundaciones de sus casas tras alud de tierra*. <https://www.soychile.cl/Tome/Sociedad/2013/05/31/177447/Vecinos-de-Dichato-sufrieron-inundaciones-de-sus-casas-tras-alud-de-tierra.aspx>. Accessed november 2021.
- The Rockefeller Foundation, and ARUP. 2015. *City Resilience Framework*. London, UK
- United Nations Office for Disaster Risk Reduction. 2020. *Home*. <https://www.undrr.org/>. Accessed on November 2021.
- United Nations Office for Disaster Risk Reduction. 2017. *The Disaster Resilience Scorecard for Cities*. <https://mcr2030.undrr.org/disaster-resilience-scorecard-cities>. Accessed on November 2021
- World-Habitat. 2021. *World Habitat Awards, Viviendas Sociales Resilientes* <https://world-habitat.org/es/premios-mundiales-del-habitat/ganadores-y-finalistas/viviendas-sociales-resilientes/#award-content>. Accessed November 2021.
- Wisnter, B., Blaikie, P., Cannon, T. y Davis, I. 2004. *At Risk: Natural Hazards, People's Vulnerability and Disasters*. Londres, Routledge.

Disparities in Green Space Accessibility and Health Outcomes in Urban Areas for Different Racial and Income Groups: A Case Study of California

Jiaying Dong¹, Dina Battisto¹

¹Architecture + Health, Clemson University, Clemson, SC

ABSTRACT: Mounting evidence has confirmed the positive effects of green space on health outcomes. Green space has long been recognized as an essential natural resource that has the power to restore ailing health, promote public health and preserve planetary health. Green space, however, is not equally distributed across the United States. In addition, studies show that disadvantaged people (those with low incomes or racial minorities) tend to have less access to green space. Thus, access to green space may be an overlooked factor in determining public health disparities. In response, this research conducted a state-wide assessment to measure the correlations between green space and health outcomes across different racial and income groups. A case study research strategy was used to explore if SES factors and health within different census tracts were related to access to green space such as public parks in California's urban areas. California was selected due to its diverse population background. Secondary datasets were utilized to obtain data for all 4,242 census tracts across 121 cities in California urban areas. The research constructs and corresponding datasets are as follows: race and income levels (US Census Bureau's American Community Survey); green space measures (Open Street Map); and health outcomes (the Centers for Disease Control and Prevention's 500 Cities Project). A spatial lag model was built to test the effect of socioeconomic factors on access to green space. Kruskal-Wallis tests showed that green space distribution varied by racial groups. Palma ratios displayed inequalities between space and health outcomes. Better green space was associated with fewer inequalities for obesity and physical health. This study suggests that policymakers and city planners should consider green space as a fundamental planning strategy to promote public health.

KEYWORDS: Green space, Health outcomes, Socioeconomic status, Inequality.

1.0 INTRODUCTION

With the rapid development of urbanization, cities have become centers for population, jobs opportunities, social services, and entertainment events. Cities provide great convenience for accessing various goods, public transportation, work and leisure activities. However, cities also suffer from escalating real estate prices, overcrowding, and congestion. They often lack natural resources. With the broadening awareness of environmental justice concerns due to exposure to environmental hazards on marginalized population groups, numerous studies have shown that access to green space contributes to improvements in community welfare and population health (Browning & Rigolon 2018). Generally, communities with higher quality natural resources tend to have premium purchase prices and are more accessible and occupied by privileged people who can afford it. Consequently, this finding suggests that green space might be unequally distributed in urban areas. The main objectives of this study are two-fold: 1). To study if relationships exist between socioeconomic groups and green space accessibility and, 2). To understand if inequities of green space across different racial groups relate to health outcomes.

1.1. Green space helps promote health outcomes

Public green space serves as an essential element to achieving a high quality of our life as nature has been shown to have positive health benefits (James et al. 2015). Green space like parks and trees has also been shown to help filter air pollution, cool temperature, decrease noise, and even aid in urban water regulation. Parks and community gardens provide public open space, where people can gather together for outdoor recreational and social opportunities. Green space can offer positive health impacts physiologically, psychologically, and even through indirect health-related human behaviors. Physiologically, green space has been shown to reduce cortisol levels, mitigate cardiovascular and respiratory diseases mortality, and even decelerate skin conductance and heart rate (Yamaguchi, Deguchi and Miyazaki 2006; Van Den Berg AE and Custers MH 2011). Studies show that when people engage in park-based leisure exercise, their self-esteem and mood increase, and anxiety and stress decrease (Orsega-Smith et al. 2004; Van den Berg et al. 2016). More substantial evidence, shown through longitudinal studies, suggests that being exposed to natural environments provides benefits for psychological health (Alcock et al. 2014; Astell-Burt, Mitchell and Hartig 2014). The mechanism that underpins the relationship between green space and health-related behaviors is attributed to more frequent outdoor physical activities, greater social cohesion, and a stronger sense of community belongings (Shanahan et al. 2016).

Considerable research has focused on mental health, physical activities, and obesity; however, conflicting results still exist. Some studies conclude weak association or even no association between green space and health outcomes (Nutsford, Pearson and Kingham 2013; Richardson et al. 2010). These contradictions imply the complexity of the mechanism between green space and human health effects, particularly when considering the local social context and specific measurements.

1.2. Socioeconomic status (SES) acts as a mediator between green space and health

How green space influences human well-being differs based on its type, amount and quality. There are ongoing debates on the inequitable distribution of green space across population groups. Results from many studies exhibit the disproportionate distributions of green space across the U.S., which are often attributed to socioeconomic factors. Since nature has health benefits, it may be inferred that the unequal distribution of green space might yield different health effects across population groups. Landry and Chakraborty (2009) found that higher median household income was the indicator most related to tree cover, while race and ethnicity were the weaker indicators studied. Sun et al. (2021) found that the amount of green space viewed from the street in Los Angeles County was inequitable across neighborhoods with different SES populations. People with low incomes and from minority groups had substantively less street green space availability. Apart from the types and amount of green space, associations between park quality and disadvantaged neighborhoods were found to vary by minority composition (Hughey et al 2016).

As indicated from the existing studies, the distribution of green space varies greatly. Ethnic and socioeconomic factors are contributing factors. Based on the poor health outcomes of disadvantaged groups, green space has been shown to influence health disparities. Browning and Rigolon (2018) found that cities in the US with most non-Hispanic Whites had stronger associations between higher tree cover than minority groups. They found cities with most non-Hispanic Whites had stronger associations between higher tree cover and low obesity, while the relationship between higher greenness and low obesity was marginal. A scoping review by Rigolon et al. (2021) concluded that people with low-SES showed more benefits from public green space than affluent people. In this regard, more knowledge is needed to uncover the complex interrelationships among race, ethnic and socioeconomic context, green space, and health outcomes.

1.3. Equity index

To help understand the complex constructs of this study, key terms will be defined. There are some different definitions regarding “equity”. *Equity* in this study means equal access by different population groups. The Gini Index, which explains the degrees of inequality across different income levels, is by far the most widely used index in environmental research (Xiao, Wang and Fang 2019; Wen, Albert and Von Haaren 2020). The Gini Index ranges from 0 to 1, with a higher value representing greater inequality. Although widely used, the Gini Index does have some flaws that cannot be ignored. It measures the inequity by focusing on the whole population, resulting in the inadequate reflection of inequity by those on the top and bottom of the distribution curve. Generally, the middle part of the curve might mitigate the possible severity caused by those at the two sides of the curve. Due to the shortcomings of the Gini Index, this study utilized a relatively new index, the Palma ratio. The Palma ratio measures equity due to changes from the richest 10% and poorest 40% of the population. Liu, Kwan and Kan (2021) have proven that this index effectively reveals the inequity gap between the richest and poorest groups.

1.4. The current study

Despite all the related studies, there are research gaps in the literature. While some studies show that green space is associated with health outcomes, few research studies investigate whether access to green space could reduce health disparities among different population groups. The Gini index commonly used in studies fails to capture the differences in population health from marginalized groups. The Palma ratio, as another equity index, has rarely been utilized in the planning field. This research addresses these gaps by focusing on the State of California as a case study.

This research study aims to answer four research questions:

1. Are there differences in green space accessibility across the 4,242 census tracts in California?
2. Are socioeconomic factors associated with green space accessibility?
3. Does green space accessibility differ across racial groups?
4. Do inequalities between green space accessibility and health outcomes exist using the Palma ratio?

2.0 METHODOLOGY

2.1. Study area: urban areas in the State of California

Given the diversity of races in large populations, the urban areas in California were selected as the study area for this research. California is a state located in the western part of the United States with approximately 403.5 billion square meters of land area. According to the US census, it has around 39.5 million population. The Median household income is \$75,235, with roughly 11.8% of the population living below the poverty line. A total of 4,242 census tracts with available data were used in the analysis. A census tract is the unit of analysis in this study. The definition of urban areas is derived from US Census Bureau’s urban-rural classification. Urban areas are delineated as those densely

developed territories which encompass at least 2,500 people. There are two types of defined urban areas: (1) urbanized areas (U.A.s) of 50,000 or more people (2) Urban Clusters (U.C.s) of at least 2,500 and less than 50,000 people. For this study, the 2010 classification of the urban area was utilized.

2.2. Research Design, data source and measurements

This study employed a case study research strategy to explore the interrelationship between socioeconomic status (SES), green space accessibility, and health outcomes. Cross-sectional data were collected for study analysis.

Socioeconomic data

Race and income are the two primary socioeconomic factors included in this study. They were obtained from the US Census Bureau 2012-2016 American Community Survey (ACS) 5-year Estimates. In this dataset, race was classified into five categories with the following percentages: White (55.57%), Black or African American (7.27%), American Indian or Alaska Native (0.66%), Asian (16.01%) and other races (16.01%) (including Native Hawaiian, other Pacific Islander, or racial groups excluding the White, African American, American Indian or Alaska). For the analysis, we only included data in which people self-identified as only one race. Percentages of each race were calculated as measurements.

As noted above, the Palma ratio was used to measure inequities between green space and three health outcomes: obesity, mental health and physical health. To determine the income level and define the cut-offs for separating the richest 10% and poorest 40% of all US census tracts, median household income for each census tract from 2012-2016 ACS 5-Year Estimates was used as the benchmark. It includes the income of the householder and all other individuals 15 years old and over in the household in the past 12 months. As a result, census tracts with less than \$46,853.00 median household income were identified as the poorest 40% and those with more than \$97,743.50 were the richest 10%. To study the relationship between socioeconomic factors and green space, the potential effects caused by extraneous variables except for race and median household income were also considered in the regression model. Table 1 shows the list of potential independent variables and extraneous variables from 2012-2016 ACS. All variables were calculated at the level of census tract.

Table 1: Socioeconomic Variables

Variables	Abbr. in the Regression Model
Percentage of White Alone	White (%)
Percentage of African American Alone	African American (%)
Percentage of American Indian and Alaska Native Alone	American Indian & Alaska Native (%)
Percentage of Asian Alone	Asian (%)
Population with Highest Education Attainment: Less than High School	Less than High School
Population with Highest Education Attainment: High School Graduate	High School Graduate
Population with Highest Education Attainment: Doctorate Degree	Doctorate Degree
Civilian Population in Labor Force 16 Years and Over: Unemployed	Pop: Unemployed
Median Household Income (In 2016 Inflation Adjusted Dollars)	Median Household Income
Gini Index of Income Inequality	Gini Index
No. Families: Income Below Poverty Level	Families Below poverty
Population driving to work	Pop: Drive
Population taking public transportation (includes Taxicab) to work	Pop: Public Transportation
Population taking motorcycle to work	Pop: Motorcycle
Population taking bicycle to work	Pop: Bicycle
Population walking to work	Pop: Walk
Population taking other means to work	Pop: Other means
Population with Health Insurance Coverage	Pop with Health Insurance
Households with Housing Costs more than 30% of Income	Households with Housing Cost > 30%

Notes: Data source: US Census Bureau 2012-2016 American Community Survey (ACS) Estimates

Green space accessibility data

Green space in this study was defined as open public space or parks within urban areas providing recreational areas for people. It involved gardens, dog parks, community parks, state parks, national parks, playgrounds, and other vegetated open space. Private gardens or golf courses that are not open to the public were excluded. Green space data were collected from OpenStreetMap (OSM), which is an online open dataset under the Open Data Commons

Open Database License (ODbL) by the OpenStreetMap Foundation (OSMF). With overpass turbo, we ran Overpass API queries to screen out green space data with geographical information. To build the queries, a list of tags, which takes the form of *key=value*, was used for matching eligible green space. The tags being used were: "leisure=park", "leisure=garden", "leisure=playground", "park:type=*", "leisure=dog_park". Census tract-level Population-Weighted Distance (PWD) was used to measure green space accessibility. PWD is a new measurement of spatial access to

parcs developed by Zhang, Lu and Holt (2011). This new measurement assumes that the probability of the population in a neighborhood that visits a park is proportional to its accessibility to the park. The steps for calculating PWD are defined as follows.

Step 1: For each census tract, spatial accessibility from a census tract (i) to a destination park (j) is denoted as A_{ij} . It is calculated by dividing the size of a destination park j in square meters (S_j) by the Euclidean distance between the centroid of the census tract i and the centroid of the nearest park j in meters (d_{ij}). α is the parameter that reflects the size effects of the nearest park j on its accessibility. β is the parameter that characterizes distance decay effects of access to nearby park j.

$$A_{ij} = S_j^\alpha / d_{ij}^\beta = S_j^{0.85} / d_{ij}^{1.91} \quad (1)$$

Step 2: The total potential spatial accessibility from one census tract (i) to nearby seven parks is denoted by A_i . It is the sum of the spatial accessibility from each census tract (i) to each nearest seven parks. Seven is the number that one could do pair-wise comparison among all alternatives with reliable validity based on previous research on psychological limits of cognition of individuals (Miller 1956).

$$A_i = \sum_{j=1}^7 A_{ij} \quad (2)$$

Step 3: P_{ij} represents the probability that a resident at a census tract (i) will choose to visit a park (j).

$$P_{ij} = \frac{S_j^{0.85} / d_{ij}^{1.91}}{\sum_{j=1}^7 S_j^{0.85} / d_{ij}^{1.91}} = A_{ij} / A_i \quad (2)$$

Step 4: Census tract-level PWD (T_i) to the nearest seven parks for the population in that census block is defined as: T_i . Pop_i is the total population of census tract i.

$$T_i = \frac{\sum_{j=1}^7 Pop_i * P_{ij} * d_{ij}}{Pop_i} = \sum_{j=1}^7 P_{ij} * d_{ij} \quad (4)$$

In summary, a census tract with a smaller PWD value shows a shorter distance to the nearest parks and thus better green space accessibility. A greater PWD value represents a census tract with a longer distance to the nearest parks. Thus, a smaller PWD means better accessibility for the census tract. These preliminary PWD calculations were performed with the “Generate near table” tool in ArcGIS 10.4.1 and then processed in RStudio.

Health data

Three health outcomes were measured: obesity, mental health, and physical health. PLACES Project, a collaboration dataset by the Centers for Disease Control and Prevention (CDC), the Robert Wood Johnson Foundation (RWJF) and CDC Foundation, provided the health data for this study. PLACES is an expansion of the original 500 Cities Project, which reports a select number of chronic disease measures for the 500 largest American cities. PLACES Project contains health model-based population-level analysis and community estimates to all data at four geographical coverage: county, place, census tract, and Zip Code Tabulation Areas. To keep consistency in data unit, the census tract-level health data 2016 release were gathered for data analysis. Health variables were specifically measured as the prevalence of obesity, the prevalence of mental health not good for ≥ 14 days among adults aged ≥ 18 years, and the prevalence of physical health not good for ≥ 14 days among adults aged ≥ 18 years.

Palma ratio

Palma ratio (P) is a new equity index that has been introduced to describe inequality based on the richest 10% and poorest 40% groups. Using this index, census tracts with median household income above 90% and below 40% were classified separately into rich and poor groups. A census tract with a higher Palma ratio indicates greater inequality. \bar{x} is the mean of a specific indicator to be measured with the Palma ratio.

$$P = \frac{\bar{x}_{top\ 10\%}}{\bar{x}_{bottom\ 40\%}} \quad (5)$$

2.3. Data analysis

Three different types of data analysis were performed: Spatial lag model, Kruskal-Wallis rank sum test, and Palma ratio. First, the Moran’s I value was calculated to discover if spatial autocorrelation exists in the SES data. Findings revealed that there was a spatial autocorrelation given the Moran’s I value of 0.41, indicating census tracts with similar SES factors tended to cluster together. Based on these findings, the spatial lag model was selected for being a better fit than multiple regression to study the relationship between socioeconomic factors and green space accessibility. For this study, the SES factors for each census tract were the independent variables. The independent variables with Variance Inflation Factor (VIF) higher than five were excluded to deal with multicollinearity. The dependent variable was green space accessibility measured by Population-Weighted Distance (PWD) for each census tract. Second, a

Kruskal-Wallis test was performed for race and health outcomes. This test is a nonparametric test for determining whether the medians from two or more groups are significantly different or not. Each census tract was classified as a specific race according to the highest percentage of the population living in the census tract. A Kruskal-Wallis rank sum test was performed to compare the PWD for all census tracts by different racial groups. A second test was conducted to compare health data across the PWD groups at the census tract level. If there were any significant differences, a post hoc Dunn's test was then performed to pinpoint which significant medians were different from the others. Third, Palma ratios were calculated for the PWD among different racial groups to study which racial group had the greatest PWD disparity. Palma ratios were also performed to study obesity, mental health, and physical health across different PWD groups. All the statistical analyses were performed in RStudio.

3.0 RESULTS

3.1. Descriptive statistics

In total, 4,242 census tracts were located within the urban areas in the State of California with available health data. Table 2 summarizes descriptive statistics of green space accessibility and three health outcomes for all sampled census tracts (N=4242). The average distance to green space within these census tracts was 1317.05 meters, with 20.21 meters being the shortest distance and 4956.78 meters being the longest. Concerning the health outcomes, the average rate of obesity was 25.18%, with a standard deviation of 5.98. Poor mental health rates across all the census tracts ranged from 4.40% to 24.20%. The average rate of poor physical health was 13.25%, and the minimum and maximum rate were 3.00% and 29.10%, respectively.

Table 2: Descriptive Statistics of Green Space Accessibility and Health Outcomes

Variables	Categories	N	Min	Mean	Max	SD
Green Space Accessibility	Population-weighted distance (PWD) in meters	4,242	20.21	1,317.05	4,956.78	637.35
Health Outcomes	Crude prevalence of obesity among adults aged >=18 years (%)	4,242	8.70	25.18	44.10	5.98
	Crude prevalence of mental health not good for >= 14 days among adults aged >=18 years (%)	4,242	4.40	12.69	24.20	3.40
	Crude prevalence of physical health not good for >= 14 days among adults aged >=18 years (%)	4,242	3.00	13.25	29.10	4.16

3.2. The relationship between SES and green space accessibility

The spatial lag model showed the relationship between the 16 SES factors and green space accessibility measured by Population-Weighted Distance (PWD). Table 3 represents a summary of the key findings. First, the census tracts with the following SES variables were negatively associated with PWD: a higher percentage of Asians, a higher number of people commuting by public transportation, motorcycle, bicycle, on walk and other means; and higher number of health insurance, and higher number of household costs > 30%. Thus, as the values of the SES factors here increases, the PWD value would decrease, indicating better green space accessibility. Second, the census tracts with the following SES variables were positively associated with PWD: higher number of high school graduates and higher median household income. This means that as the values of the SES factors here increased, the PWD value would decrease, indicating worse green space accessibility. This result is interesting because, as a rule of thumb, green space is more accessible by rich people.

Table 3: Regression Results for SES Variables and Green Space Accessibility.

SES Variables	Estimate	Std. Error	t value	Pr (> t)
(Intercept)	1361.650	95.637	14.238	0.000***
White (%)	37.836	85.514	0.442	0.658
African American (%)	151.950	121.504	1.251	0.211
American Indian & Alaska Native (%)	-1384.390	860.867	-1.608	0.108
Asian (%)	-543.563	98.937	-5.494	0.000***
High School Graduate	0.376	0.046	8.158	0.000***
Pop: Unemployed	0.033	0.109	0.300	0.764
Median Household Income	0.001	0.001	1.651	0.099*
Gini Index	58.966	153.654	0.384	0.701
Families Below poverty	0.115	0.117	0.984	0.325
Pop: Public Transportation	-0.344	0.054	-6.418	0.000***
Pop: Motorcycle	-1.207	0.664	-1.819	0.069*

		RESILIENT CITY Physical, Social, and Economic Perspectives		
Pop: Bicycle	-0.987	0.234	-4.226	0.000***
Pop: Walk	-0.284	0.098	-2.913	0.004***
Pop: Other means	-0.401	0.238	-1.685	0.092*
Pop with Health Insurance	-0.039	0.013	-3.047	0.002***
Households with Housing Cost > 30%	-0.085	0.052	-1.646	0.100*

Note: *P ≤ 0.1. **P ≤ 0.05. ***P ≤ 0.01. R-squared = 0.117, adjusted R-squared = 0.114. p-value: 0.000.

3.3. Green space accessibility by racial groups

As indicated in Table 4, census tracts comprised of a majority of African Americans have, on average, the furthest distance to green space (highest PWD) than other racial groups. To evaluate the differences in green space accessibility across racial groups, the Kruskal-Wallis test was utilized. The test revealed a significant difference (p-value < 0.05) on PWD value across racial groups. To study this further, a Dunn's post hoc test was conducted to figure out if any two groups are statistically significant. The comparison between the white population group and the "other races" group (Native Hawaiian, other Pacific Islander, or racial groups excluding the White, African American, American Indian or Alaska) showed a statistical significance at 0.1 level. All other pairs were statistically significant at the 0.01 level. This finding suggests that African Americans tended to live farthest from green space with 1481.2 meters among all races, while Asian populations lived the closest to green space with 1112.35 meters. White population ranked second after Asians with an average PWD of 1317.05 meters.

Table 4: Kruskal-Wallis Test on Population Weighted Distance (PWD) across Racial Group

Racial Groups	N	Min	Mean	Max	SD	Test Statistics		
						Chi-squared	df	P
All Census Tracts (CTs)	4242	20.21	1317.05	4956.78	637.35			
CTs with White Majority	1260	20.21	1329.08	4956.78	651.62			
CTs with African American Majority	122	214.20	1481.20	2596.10	567.31			
CTs with Asian Majority	411	48.06	1112.35	3550.92	511.59	61.60	3	2.68e-13***
CTs with other races Majority	401	90.25	1377.72	3958.29	612.10			

*P ≤ 0.1. **P ≤ 0.05. ***P ≤ 0.01.

3.4. Health outcomes by different levels of green space accessibility

To understand whether green space accessibility is associated with obesity, mental health and physical health, green space accessibility was grouped into five categories with five quintiles. A smaller PWD value means a shorter distance to the nearest seven parks, hence better green space accessibility. Kruskal-Wallis tests with those three health outcomes were conducted respectively. The results report significant differences for all three health outcomes at the 0.01 level. For obesity prevalence, there was a steadily growing trend, showing that people who lived farther away from green space were more likely to be overweight. In contrast, the prevalence of mental health and physical health represent a more modest increased with more distance to green space.

Table 5: Kruskal-Wallis Test on Health Outcomes Across Different Levels of Green Space Accessibility

Health Outcomes	Green Space Accessibility	Population-Weighted Distance (PWD) in five quintiles	N	Mean Rank	Test Statistics		
					Chi-squared	df	P
Obesity	Best	1 st quintile: ≤20.0%	848	23.47	145.35	4	< 2.2e-16***
	Better	2 nd quintile: 20.1%-40.0%	849	24.57			
	Middle	3 rd quintile: 40.1%-60.0%	848	25.66			
	Worse	4 th quintile: 60.1%-80.0%	849	25.71			
	Poorest	5 th quintile: ≥80.1%	848	26.51			
Mental	Best	1 st quintile: ≤20.0%	848	11.96	75.158	4	1.845e-15***
	Better	2 nd quintile: 20.1%-40.0%	849	12.53			
	Middle	3 rd quintile: 40.1%-60.0%	848	13.06			
	Worse	4 th quintile: 60.1%-80.0%	849	12.82			
	Poorest	5 th quintile: ≥80.1%	848	13.06			
Physical	Best	1 st quintile: ≤20.0%	848	12.19	122.26	4	< 2.2e-16***
	Better	2 nd quintile: 20.1%-40.0%	849	13.03			
	Middle	3 rd quintile: 40.1%-60.0%	848	13.66			
	Worse	4 th quintile: 60.1%-80.0%	849	13.55			
	Poorest	5 th quintile: ≥80.1%	848	12.85			

Note: *P ≤ 0.1. **P ≤ 0.05. ***P ≤ 0.01. A smaller PWD value means better accessibility. A quintile is a 1/5th (20 percent) portion of the whole. Five quintiles divide PWD into five equal groups.

3.5. Palma ratio of green space accessibility and health outcomes

The comparison of the Palma ratios allows for the analysis between two marginalized groups: richest 10% and poorest 40%. A Higher Palma ratio indicates greater inequality. Table 6 shows that African American (Palma ratio = 1.714) was the only group with a Palma ratio larger than 1. The “other races” group had the second-highest Palma ratio: 1.028. White and Asian populations had similar Palma ratios. To be precise, Asian had the least Palma ratio, suggesting Asian populations tended to have the most equal access to green space between the richest 10% group and the poorest 40% group.

Table 6: Palma Ratio of Green Space Accessibility Across Races

Races	Palma Ratio of PWD	N for all CTs	N for richest 10% group	N for poorest 40% group
All census tract	0.867	2005	625	1380
White	0.879	1428	524	904
African American	1.714	72	1	71
Asian	0.841	191	99	92
Other Races	1.028	314	1	313

Next, the analysis of Palma ratios in Table 7 shows if disparities of three health outcomes exist across green space accessibility. The inequalities of obesity and physical health at the census tract level increase with less access to green space. Health inequality was most severe for populations that lived the furthest distance to green space. Mental health stayed relatively stable across the PWD in the five quintiles.

Table 7: Palma Ratios of Health Outcomes Across Levels of Green Space Accessibility

Green Space Accessibility	Population-Weighted Distance (PWD) in five quintiles	Palma Ratio		
		Obesity	Mental Health	Physical Health
Best	1 st quintile: ≤20.0%	0.614	0.535	0.482
Better	2 nd quintile: 20.1%-40.0%	0.599	0.529	0.490
Middle	3 rd quintile: 40.1%-60.0%	0.618	0.535	0.496
Worse	4 th quintile: 60.1%-80.0%	0.625	0.540	0.512
Poorest	5 th quintile: ≥80.1%	0.635	0.530	0.518

Note: Smaller PWD value means better accessibility. A quintile is a 1/5th (20 percent) portion of the whole. Five quintiles divide PWD into five equal groups.

4.0 DISCUSSIONS

In this study, urban areas in California illustrated the complex interrelationship among socioeconomic status, green space accessibility and health outcomes. By taking advantage of the Palma ratio, we can better understand the concept of inequality. This case study of California triggers some critical thoughts regarding the interrelationships between SES factors, green space, and health outcomes.

4.1. The impact of socioeconomic status (SES) on green space accessibility

Among all the SES variables, a total of 10 variables showed significant associations with green space accessibility. Among all the races, the Asian populations was the only racial group significantly related to green space accessibility. Asians tended to live in areas with a shorter distance to green space. This was also supported by the following Kruskal-Wallis test, which suggested that the majority-Asian census tracts had the shortest average distance to green space. What is surprising is the significant positive coefficient of high school graduates and positive coefficient of median household income with green space, although the slope coefficient was as small as 0.01 for median household income. In short, these two associations indicated that lower-income people and people without high school diploma were more likely to live closer to green space. This outcome is contrary to that of Astell-Burt et al. (2014), who found green space availability was lower for a higher percentage of low-income residents. One possible reason for our finding refers to the “White Flight” (Woldoff 2011), which describes the migration of high-income people from inner cities to the suburbs in the post World War II era. Suburbs tend to have a more scattered distribution of green space; thus, high-income people possibly live farther away from green space than low-income people. Plus, the discrepancy in cases (e.g. Australia versus United States) and green space measurements might also account for it. In addition, five groups of commuter modes were negatively associated with PWD. Those who take public transportation, motorcycle, bicycle, walk and other means to work had better green space accessibility. Given that this is only a reflection of commuter mode choice, further study is required to address modes of transportation that might relate to green space disparity. Although we cannot directly infer that green space could increase house value, we did find a trend that households with housing cost more than 30% of their income tended to have better access to green space.

It is possible to hypothesize that the cost of living near green space is relatively higher as compared to living further to it. This study also found that green space accessibility did differ across different racial groups. Census tracts represented by an African American majority had the furthest distance to nearest parks (larger PWD) than other racial groups. Asians had the best access to green space, followed by the white population. Our finding broadly supports the work of other studies in this area linking races to green space access.

4.2. The association between green space accessibility and health outcomes

Prior studies have validated the link between green space exposure and human health (James et al. 2015). This is also confirmed in our Kruskal-Wallis analysis, revealing that better access to green space was associated with fewer obesity rates, mental health problems and physical health problems. It is noteworthy that the fluctuation in mental and physical health was minor. Studies at a finer scale can help to figure out the underlying complex mechanisms for these findings. It is possible that Population-Weighted Distance cannot capture all aspects of green space accessibility. Green space quality might be another influential element to be considered in future studies. Taking these features into account might display more remarkable results. Besides, this study only looked at the general aspect of health conditions: obesity, mental health and physical health. More health outcomes like cardiovascular disease and chronic disease are worthwhile exploring in relation to green space.

4.3. Palma ratio

Similar to other studies on green space disparities, African Americans had the greatest inequality in green space accessibility (Table 6). However, the data are not as reliable as expected due to the small sample size (n=72 with only one census tract in the richest 10%) of the census tract with the African American majority. Additional studies on other areas are crucial to establish the validity of this result. The Asian group had the best green space accessibility and the least green space inequality (0.026 less than average). Likewise, Palma ratios on health outcomes across levels of green space accessibility generated impressive findings (Table 7). As the distance to green space became longer, the obesity rates and physical health rates gradually became more unequal, represented as higher Palma ratios. The change in mental health was not so noticeable. These findings seem to be in line with earlier studies which found parks were important to the development of obesity and physical health (Leal & Chaix, 2011). According to the data, the change of green space accessibility did not greatly alter mental health equity. It is possible to hypothesize a weaker or less noticeable link between green space and mental health.

4.4. Limitations and future research

The limitations of this study have to be recognized. First, population-weighted distance as the measurement of green space accessibility assumes that the closer the park is, the higher the possibility of visiting it. However, this is not always the case in real life. Whether people will visit a park is subject to a variety of other factors. Perhaps more studies at a smaller scale with subjective surveys would be helpful. Secondly, health data were extracted from adults older than 18 years old. Results might be somewhat different if children are considered. Thirdly, the number of African American-majority census tracts was small (122 of the 4,242 census tracts). Therefore, there was a lower representation of African Americans in the census tracts in the richest 10% and poorest 40%. Finally, though OpenStreetMap has been successfully applied worldwide, and a subsequent examination of data layers was taken, the accuracy of park information is substantially important. This can only be achieved by cooperating contributors. Future work on dataset improvement or modification might produce more infallible results.

CONCLUSION

Overall, this study found that green space distribution varies by different race and income groups. More importantly, this study advances previous research by introducing Palma ratio to measure inequalities of green space and health outcomes. Better access to green space is associated with fewer inequalities of obesity and physical health. This information can be used for policymakers and city planners to develop targeted interventions aimed at achieving green space equity and public health for all populations

REFERENCES

- Alcock, Ian, Mathew P. White, Benedict W. Wheeler, Lora E. Fleming, and Michael H. Depledge. "Longitudinal effects on mental health of moving to greener and less green urban areas." *Environmental science & technology* 48, no. 2 (2014): 1247-1255.
- Astell-Burt, Thomas, Richard Mitchell, and Terry Hartig. "The association between green space and mental health varies across the lifecourse. A longitudinal study." *J Epidemiol Community Health* 68, no. 6 (2014): 578-583.
- Astell-Burt, Thomas, Xiaoqi Feng, Suzanne Mavoa, Hannah M. Badland, and Billie Giles-Corti. "Do low-income neighbourhoods have the least green space? A cross-sectional study of Australia's most populous cities." *BMC Public Health* 14, no. 1 (2014): 1-11.
- Browning, Matthew HEM, and Alessandro Rigolon. "Do income, race and ethnicity, and sprawl influence the greenspace-human health link in city-level analyses? Findings from 496 cities in the United States." *International journal of environmental research and public health* 15, no. 7 (2018): 1541.

- Hughey, S. Morgan, Katrina M. Walsemann, Stephanie Child, Alicia Powers, Julian A. Reed, and Andrew T. Kaczynski. "Using an environmental justice approach to examine the relationships between park availability and quality indicators, neighborhood disadvantage, and racial/ethnic composition." *Landscape and Urban Planning* 148 (2016): 159-169.
- James, Peter, Rachel F. Banay, Jaime E. Hart, and Francine Laden. "A review of the health benefits of greenness." *Current epidemiology reports* 2, no. 2 (2015): 131-142.
- Landry, Shawn M., and Jayajit Chakraborty. "Street trees and equity: evaluating the spatial distribution of an urban amenity." *Environment and Planning a* 41, no. 11 (2009): 2651-2670.
- Leal, C., and B. Chaix. "The influence of geographic life environments on cardiometabolic risk factors: a systematic review, a methodological assessment and a research agenda." *Obesity reviews* 12, no. 3 (2011): 217-230.
- Liu, Dong, Mei-Po Kwan, and Zihan Kan. "Analysis of urban green space accessibility and distribution inequity in the City of Chicago." *Urban Forestry & Urban Greening* 59 (2021): 127029.
- Miller, George A. "The magical number seven, plus or minus two: Some limits on our capacity for processing information." *Psychological review* 63, no. 2 (1956): 81.
- Mills, Edwin S., and Richard Price. "Metropolitan suburbanization and central city problems." *Journal of Urban Economics* 15, no. 1 (1984): 1-17.
- Nutsford, D., A. L. Pearson, and S. Kingham. "An ecological study investigating the association between access to urban green space and mental health." *Public health* 127, no. 11 (2013): 1005-1011.
- Orsega-Smith, Elizabeth, Andrew J. Mowen, Laura L. Payne, and Geoffrey Godbey. "The interaction of stress and park use on psycho-physiological health in older adults." *Journal of Leisure Research* 36, no. 2 (2004): 232-256.
- Richardson, Elizabeth, Jamie Pearce, Richard Mitchell, Peter Day, and Simon Kingham. "The association between green space and cause-specific mortality in urban New Zealand: an ecological analysis of green space utility." *BMC public health* 10, no. 1 (2010): 1-14.
- Rigolon, Alessandro, Matthew HEM Browning, Olivia McAnirlin, and Hyunseo Violet Yoon. "Green space and health equity: a systematic review on the potential of green space to reduce health disparities." *International journal of environmental research and public health* 18, no. 5 (2021): 2563.
- Shanahan, Danielle F., Robert Bush, Kevin J. Gaston, Brenda B. Lin, Julie Dean, Elizabeth Barber, and Richard A. Fuller. "Health benefits from nature experiences depend on dose." *Scientific reports* 6, no. 1 (2016): 1-10.
- Sun, Yi, Xingzhi Wang, Jiayin Zhu, Liangjian Chen, Yuhang Jia, Jean M. Lawrence, Luo-hua Jiang, Xiaohui Xie, and Jun Wu. "Using machine learning to examine street green space types at a high spatial resolution: Application in Los Angeles County on socioeconomic disparities in exposure." *Science of The Total Environment* 787 (2021): 147653.
- Van Den Berg, Agnes E., and Mariëtte HG Custers. "Gardening promotes neuroendocrine and affective restoration from stress." *Journal of health psychology* 16, no. 1 (2011): 3-11.
- Van den Berg, Magdalena, Mireille van Poppel, Irene van Kamp, Sandra Andrusaityte, Birute Balseviciene, Marta Cirach, Asta Danileviciute et al. "Visiting green space is associated with mental health and vitality: A cross-sectional study in four european cities." *Health & place* 38 (2016): 8-15.
- Wen, Chen, Christian Albert, and Christina Von Haaren. "Equality in access to urban green spaces: A case study in Hannover, Germany, with a focus on the elderly population." *Urban Forestry & Urban Greening* 55 (2020): 126820.
- Woldoff, Rachael A. *White flight/black flight*. Cornell University Press, 2011.
- Xiao, Yang, De Wang, and Jia Fang. "Exploring the disparities in park access through mobile phone data: Evidence from Shanghai, China." *Landscape and urban planning* 181 (2019): 80-91.
- Yamaguchi, Masahiro, M. Deguchi, and Yoshifumi Miyazaki. "The effects of exercise in forest and urban environments on sympathetic nervous activity of normal young adults." *Journal of international medical research* 34, no. 2 (2006): 152-159.
- Zhang, Xingyou, Hua Lu, and James B. Holt. "Modeling spatial accessibility to parks: a national study." *International journal of health geographics* 10, no. 1 (2011): 1-14.

Observations of Thermal Comfort Conditions in Two Schools in Southern California and Nairobi, Kenya

David Mwale Ogoli¹

¹California Baptist University, Riverside, CA

ABSTRACT: The ANSI/ASHRAE Standard 55-2020 described a new adaptive comfort standard for thermal environmental conditions for human occupancy. These conditions allow warmer indoor temperatures for naturally ventilated buildings in warm climatic zones. This is a field study in two naturally ventilated educational buildings located on two continents in similar climatic zones, namely, southern California and the equatorial highland regions of Nairobi, Kenya. The environmental factors that were collected were temperature, thermal radiation, humidity, air speed and personal factors of clothing and activity. Other related non-thermal factors of indoor air quality, architectural acoustics, lighting, biologics and chemical factors that could affect comfort and health were not collected. Two sample schools were modelled using building information modelling (BIM). Simulations were done using Computational Fluid Dynamics (CFD) to study air flow and thermal comfort. Measured data were gathered in the school building in California for comparison and validation. The paper summarizes some measured observations made using 100 college students working in their regular settings using existing adaptive comfort research. Some of the findings are that for naturally ventilated buildings, the process of getting the adaptive comfort needs careful interpretation in order to avoid energy-consuming mechanical HVAC systems based on the comfort settings of Standard 55-2020. The study confirms that when humans are considered as laboratory subjects, they tend to have a universally agreeable thermal comfort range about 65°F – 78°F (18.3°C-25.6°C) but when they are given more control of their living or workspace, the comfort range widens. The cost benefit of energy-savings potential and improved indoor air quality are real for developing regions for the peoples living in socially, economically, culturally and technologically divergent regions. Finally, the paper discusses possible new directions for building science researchers, architects and engineers for the improvement of building environmental control systems.

KEYWORDS: Comfort, temperature, humidity, ventilation and energy-efficiency.

1.0 INTRODUCTION

Since the late 1960's, thermal comfort models have been guided by the predictive mean vote (PMV) and predicted percent of dissatisfaction, (PPD) developed by P.O. Fanger in Denmark. In the mid 1970's, researchers around the world began to develop the Adaptive Model which has rapidly grown in widespread application globally. Many studies done on thermal comfort are well documented from the works of Olgay, Givoni, Fanger, Humphreys, deDear, Nicol, Nishi, Rohles, and Szokolay, among others (Fanger, 1970; Givoni, 1976). Results of these studies have been incorporated in various publications by the American Society of Heating, Refrigerating and Air-conditioning Engineers (ASHRAE).

Thermal Comfort is defined by *ASHRAE Standard-55* as "That condition of mind that expresses satisfaction with the thermal environment and is assessed by subjective evaluation." Thermal comfort is affected by physical, psychological, physiological, and behavioral factors. Architects have been working towards achieving thermal comfort since time immemorial. Victor Olgay (1963) wrote *Design with Climate*, as a means of relating factors that connect people, climate and environment. Human need for shelter has always been towards comfort and protection from harmful environmental conditions (Pollio, 2018). As thermal comfort conditions improve, human performance and productivity increases also in buildings for work, education, and shelter (Mohamed & Korb, 2005). A study (Van Hoof & Janesen, 2007) noted and quantified the relevance of adaptive thermal comfort models in moderate thermal climate zones. Thermal comfort has a direct link to energy efficiency in buildings since it is tied to the local climate.

However, most recent studies were done in countries that tend to have similar climatic, socio-economic and cultural conditions that may or may not be extrapolated to other parts of the world. It is well known that people in less developed countries tend to adapt to a wider range of thermal comfort conditions that may be explained by the adaptive model. Researchers need to carefully examine ways to improve energy efficiency in an educational building on sites that have wide climatic conditions.

There is, therefore, a growing need to evaluate the use, applicability and performance of these models in terms of thermal comfort and energy efficiency for educational buildings in, for example, the highly populated climate of southern

California. The California Energy Code is designed to reduce wasteful and unnecessary energy consumption in new and existing buildings. California Energy Commission published in December 2018 the “Building Energy Efficiency Standards that focuses on several key areas to improve the energy efficiency of newly constructed buildings and additions and alterations to existing buildings. The most significant efficiency improvements to the residential Standards include the introduction of photovoltaic into the prescriptive package, improvements for attics, walls, water heating, and lighting. The most significant efficiency improvements to the nonresidential Standards include alignment with the ASHRAE 90.1 2017 national standards.” (California Energy Commission, 2019:6). The paper suggests that there is a distinction between thermal comfort responses in air-conditioned vs. naturally ventilated buildings. It suggests that an emerging need of adaptive factors for thermal comfort may influence results of one’s thermal experiences and expectations.

1.1 Climate of Riverside, CA

The City of Riverside California is located on latitude 33.95°N and longitude 117.44°W at an elevation of 804 feet (245 m) above sea level. On average it receives about 11 inches (280 mm) of rain annually. The US average rainfall is 38 inches (965 mm) per annum. The City of Riverside gets 0 inches (0 mm) of snow per year with the US average being 28 inches (711 mm) of snow per year. On average Riverside gets about 277 sunny days per year where the US average is 205 sunny days.

The climate of Riverside, California is generally hot and dry. The summer (July) high dry-bulb temperature is about 94°F (34.4°C) while the winter (January) low is 42°F (5.6°C). Average relative humidity ranges between 10% in winter (January) and 75% in summer (July). It is a hot dry climate. This climate can be summarized as about 1357 heating degree days (base 65°F) and 1823 cooling degree days (base 65°F), a ratio of about 1:1.34. This is about even. Annually, the city is about 11.8% of the time within the ASHRAE Comfort zone (Figure 1).

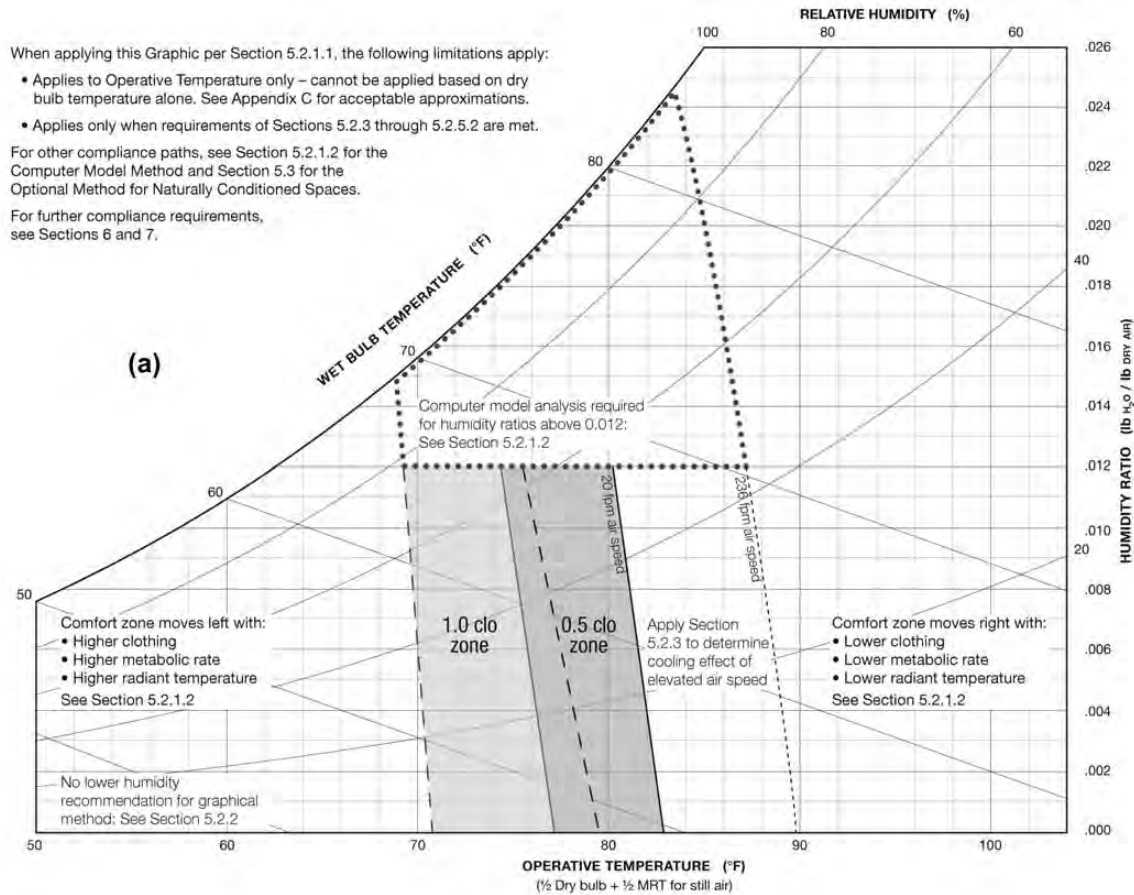

Figure 1: ASHRAE Comfort Zone (Source: ASHRAE Handbook of Fundamentals 2021)

Compared to the climate of Riverside, CA, Nairobi (Kenya) is moderate and can be summarized by the temperature and degree-days shown in Tables 1, 2 and 3. Nairobi is a highland equatorial region while Riverside is a low-lying outside the tropics. The ratio of heating days to cooling degree-days for Riverside is about 1:1.34 while that corresponding ratio for Nairobi is about 1:9. Nairobi barely requires any heating at all while cooling requirements are moderate.

Table 1: Heating and Cooling degree days

	RIVERSIDE, CA	NAIROBI, KENYA
LATITUDE	33.95°N	1.32°S
LONGITUDE	117.44°W	36.93°E
ELEVATION	804 feet (245m)	5327 feet (1624m)
HEATING DEGREE DAYS (BASE 65)	1357	126
COOLING DEGREE DAYS (BASE 65)	1823	1151

Table 2: Riverside, CA Latitude 33.95°N and longitude 117.44°W

	JAN	FEB	MAR	APR	MAY	JUN	JUL	AUG	SEP	OCT	NOV	DEC
HIGH (°F)	68	68	71	76	80	87	94	95	91	83	74	67
LOW (°F)	43	44	46	49	54	57	62	62	59	53	46	42

Table 3: Nairobi Kenya is on latitude 1.32°S and 36.93°E.

	JAN	FEB	MAR	APR	MAY	JUN	JUL	AUG	SEP	OCT	NOV	DEC
HIGH (°F)	79	81	80	77	75	73	72	73	77	79	76	76
LOW (°F)	59	59	61	61	59	56	54	55	56	59	60	59

Figure 2 shows some of design strategies recommended for non-domestic buildings in Riverside that can attain 21.3% in sun-shading of windows, 18.9% high thermal mass with nighttime flushing (1660 hours of the total annual 8760 hours), 13.9% adaptive comfort ventilation (1216 hours), 17.4% passive solar direct gain high mass (1524 hours), and 20.9% direct heating with additional humidification as needed for about 1827 hours annually. Buildings can achieve comfort for about 11.8% (1037 hours annually) under California Energy Code Model.

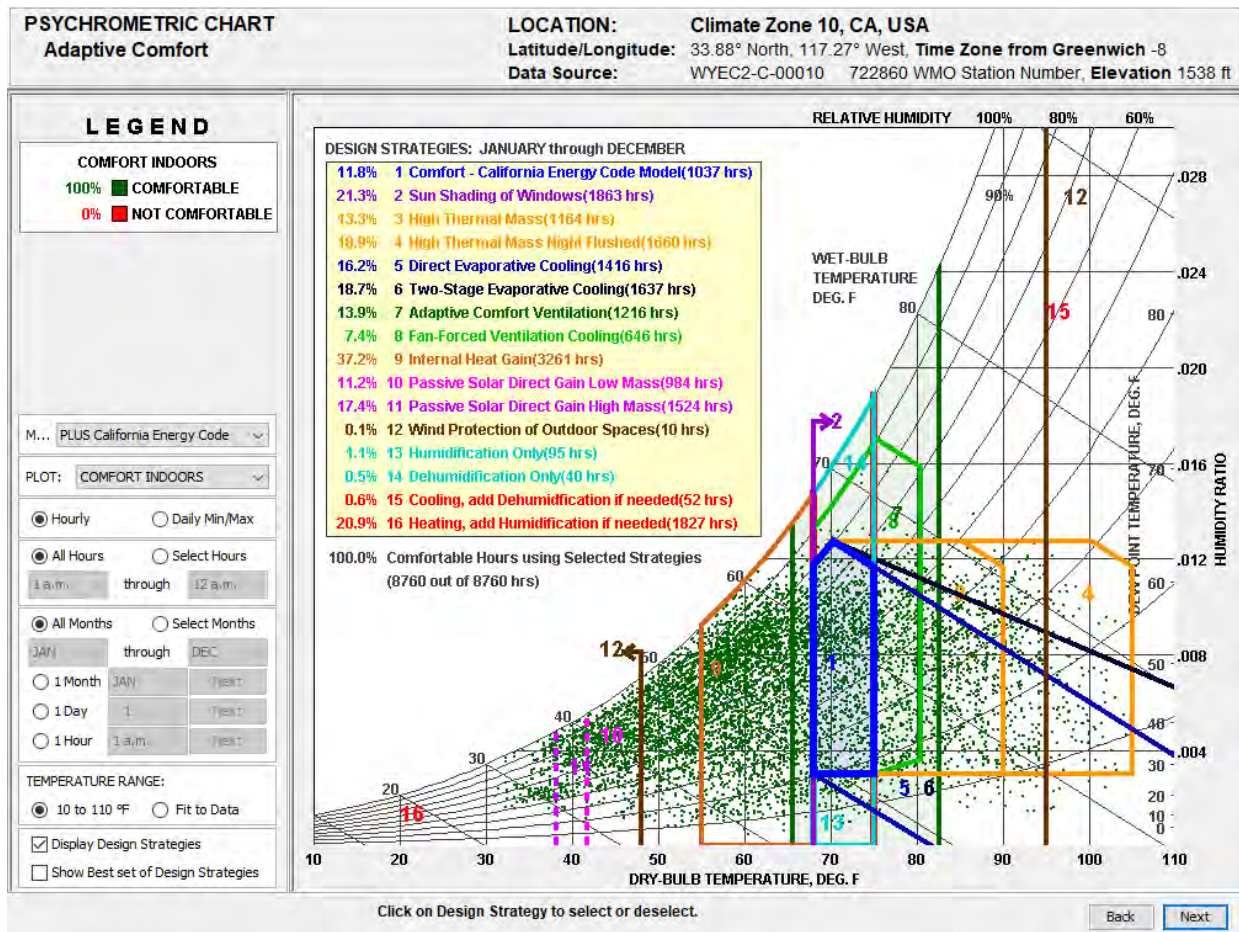

Figure 2: Psychrometric Chart for Riverside, CA (generated by Climate Consultant version 6.0)

Observations of Thermal Comfort Conditions in Two Schools in Southern California and Nairobi, Kenya

The California Energy Code (Title 24) can be seen on the psychrometric chart with two parallel sides defined by the comfort low and comfort high dry bulb temperatures at 68°F (20°C) for heating to 75°F (23.9°C) for cooling. The Code does not define comfort limits for humidity. In *Climate Consultant* the sloped top of the comfort zone is “defined by the highest relative humidity at the comfort low temperature, and follows the wet bulb temperature line. Using 80% relative humidity at the comfort low temperature of 68°F (20°C) corresponds to 66°F (18.9°C) wet bulb which is reasonable. The lowest comfortable humidity is shown as the flat bottom of this zone as defined by the minimum dew point temperature which is set at 27°F (-2.8°C)” (*Climate Consultant version 6.0, 2018*).

1.2 Experimental Setup

CBU Architecture Building has two levels comprising of about 36,000 SF (3345m²) academic space (Figure 3). It has central VAV, HW Heat, Chiller 5.96 COP and boilers at 84.5% efficiency. The building has classrooms, offices and other support spaces. The main occupants of the building are students. Measured and simulated data were gathered to assess thermal comfort.



Figure 3: Architecture Building Level 1

The personal factors of occupants included activity (metabolic rates) and clothing (thermal insulation values). Research subjects were classified by gender, age, education, personal health condition. Alongside these factors, the psychological expectations (knowledge, experience, psychological effect of visual warmth by, say, direct sunlight) were observed. There is mounting evidence (Humphreys, 1996; Karyono, 2000) that suggests that thermal perceptions are affected by factors that are not recognized by current ASHRAE comfort standards in naturally ventilated spaces. Hence, this study is one in a series aimed to try to answer and explain some of the factors.

2.0 OBSERVATIONS

Measured and simulated data were observed. Thermal sensation questionnaire consisting of the ASHRAE seven-point comfort scale was conducted with 35 student subjects in CAVAD Architecture Building starting at 1:00 PM during their normal studio sessions on October 28, 2019. Figure 4 shows the energy analytical model and Figure 5 the lighting conditions in the building that were adequate supporting learning activities in all studio areas except the interior services spaces (restrooms, etc.).

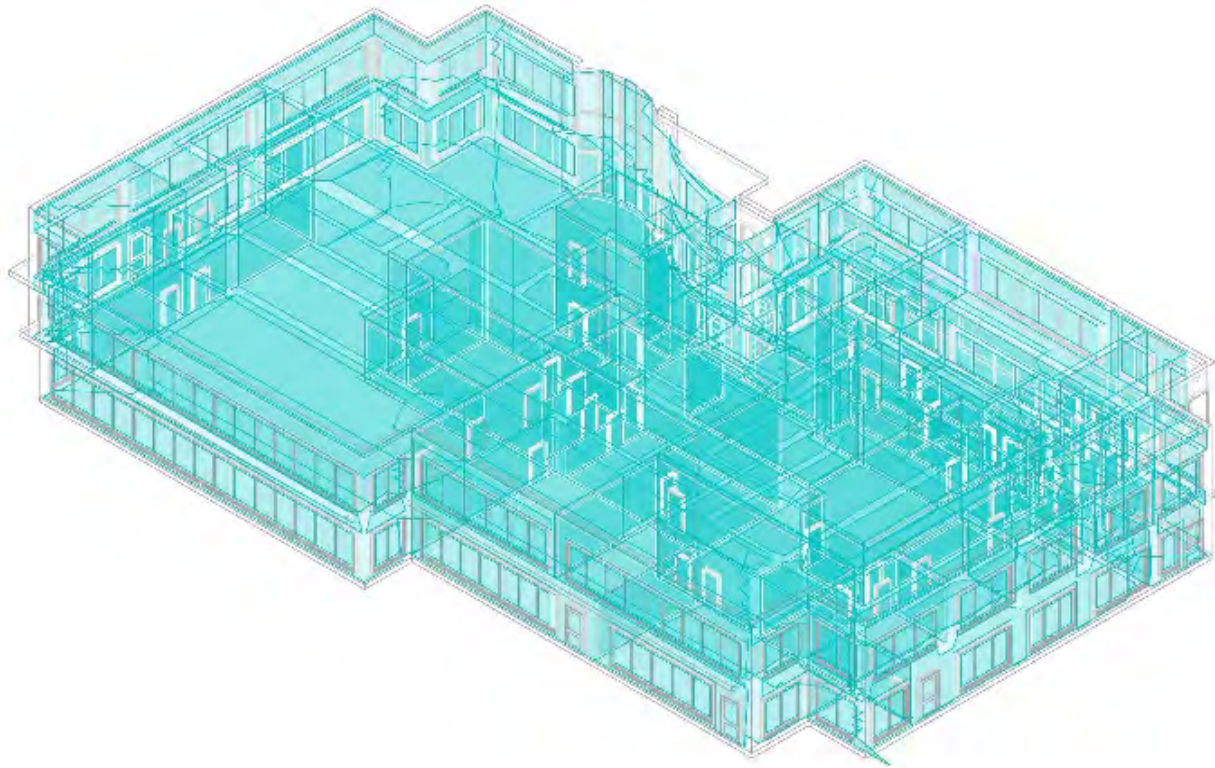

Figure 4: Energy Analytical Model (generated by Autodesk Insight 360)

Observation of the measured and simulated data showed that students were within the Psychrometric Chart comfort zone as defined by dry bulb temperature and humidity. The primary difference between the three comfort models, namely California Energy Code, ASHRAE Standard-55 PMV/PPD, and Adaptive model was the length of comfort hours. The adaptive model was the longest. Duration of the test period was three of hours of studio work when the students in the occupied spaces were assessed for thermal comfort conditions. Different comfort models have a different effect on the number of hours that fall within the comfort zone.

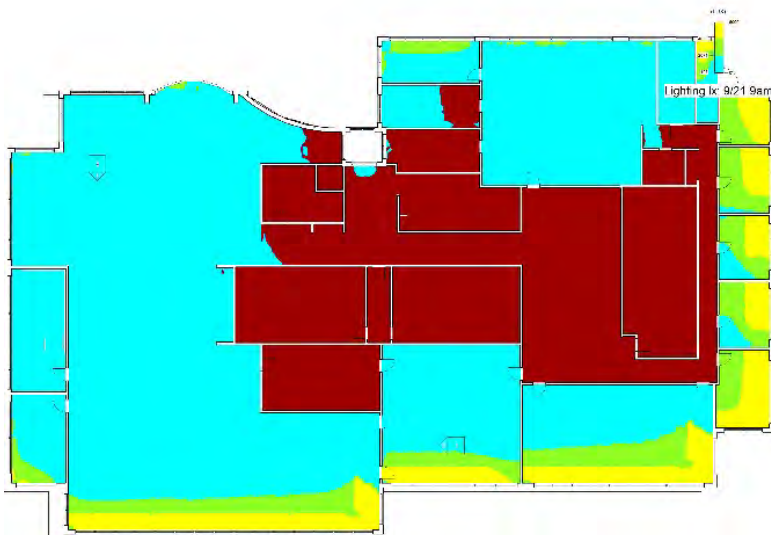

Figure 5: Architecture Building Level 2 Lighting Conditions

Observations of Thermal Comfort Conditions in Two Schools in Southern California and Nairobi, Kenya

Figure 6 shows some of the building design strategies undertaken to ensure energy-efficiency include proper insulation, window-wall-ratio on south-facing façades, lighting efficiency of 0.3 W/ft² LDP (lighting power density), provision of daylighting & occupancy controls and high-efficiency HVAC system. The building performance met industry requirements set in ASHRAE Standard 90 and almost achieved the Architecture 2030 Standards.

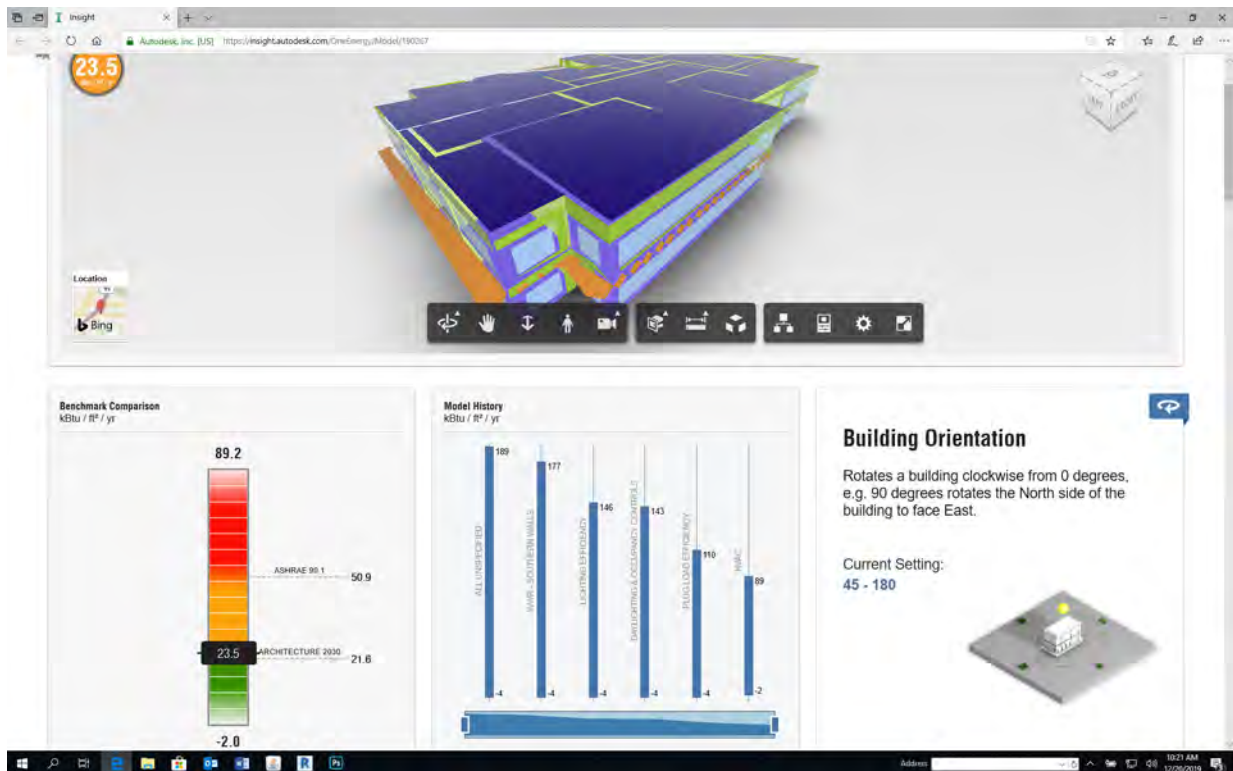

Figure 6: Building Performance Analysis (generated by Autodesk Insight 360)

Comparing the measured data gathered by instruments and questionnaire with simulated data gathered by software and formulae shows that predicting thermal comfort sensation of occupants in the academic building may not always be accurate. Measured data provided a better more complete perception of responses than those simulated. The two sets of methodologies can be refined to bridge the gap.

3.0 ANALYSIS AND DISCUSSION

ASHRAE *Handbook of Fundamentals* (2021) noted that “the conscious mind appears to reach conclusions about thermal comfort and discomfort from direct temperature and moisture sensations from the skin, deep body temperatures, and the efforts necessary to regulate body temperatures). In general, comfort occurs when body temperatures are held within narrow ranges, skin moisture is low, and the physiological effort of regulation is minimized. Comfort also depends on behaviors that are initiated consciously or unconsciously and guided by thermal and moisture sensations to reduce discomfort. Some examples are altering clothing, altering activity, changing posture or location, changing the thermostat setting, opening a window, complaining, or leaving the space.”

A research question arising from the observations regards the role of architecture in attainment of thermal comfort within the built environment. Buildings have their own internal environment but they also are part of the large external environment. Achieving thermal comfort should include the following climatic factors (Szokolay, 2008:29):

- 1) Temperature
- 2) Humidity
- 3) Air Movement
- 4) Precipitation
- 5) Cloud Cover
- 6) Sunshine Duration
- 7) Solar Radiation

People are comfortable in a wide range of conditions found globally. They are probably affected by socio-economic and cultural expectations.

Previous studies on college-age students noted in *ASHRAE 2021 Handbook of Fundamentals* that Rohles (1973) and Rohles and Nevins (1971) showed correlations between comfort, temperature, humidity, gender, and length of exposure. Those studies led to the development of the ASHRAE thermal sensation scale:

- +3 hot
- +2 warm
- +1 slightly warm
- 0 neutral
- 1 slightly cool
- 2 cool
- 3 cold

Based on the *ASHRAE Standard 55* PMV/PPD model, the percentage of occupants thermally dissatisfied with the indoor environment in the CAVAD Architecture building is 42%. This is a large number of test subjects voting that the environment was not comfortable. Discomfort in the environment may have been due to the cooler than normal temperature in the environment. Using PMV = -1.35, the PPD graph is shown below (Figure 7):

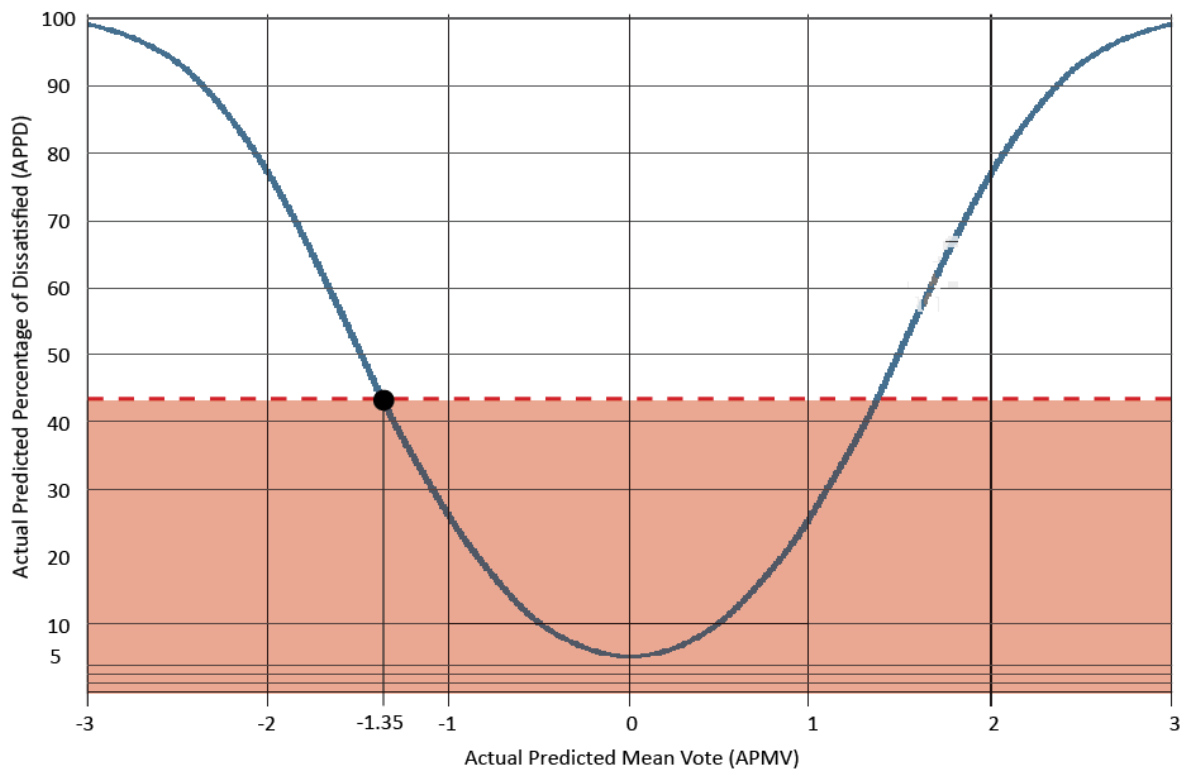

Figure 7: PMV/PPD in Architecture Building (Riverside, CA)

Adaptive thermal comfort models are an observation of constantly changing conditions under which people live and work in buildings. When people are able to adjust their surroundings for adaption, they tend to be comfortable at wider ranges. It was observed that the adaptive activities can increase the perception of comfort to a range of air temperatures from about 63°F (20°C) to 88°F (31.1°C) (Humphreys and Nicol 1998). They showed that the adaptive model when applied to a wide range of buildings, climates, and cultures is given by:

$$t_c = 75.6 + 0.43(t_{out} - 71.6) \exp\left(-\frac{t_{out} - 71.6}{61.1}\right)$$

Where:

- t_c = comfort temperature, and
- t_{out} = monthly mean outdoor temperature

Adaptive models can help to make architectural design and energy-efficiency decisions. Such decisions must integrate thermal comfort, lighting and energy efficiency. According to a recent study (Sandeep, Haberl, Clayton, & Yan, 2014) "Building performance analyses are important aspects of designing sustainable buildings. One of the performance

analyses done by architects is to predict how buildings are performing in terms of their luminous environment as a result of daylighting”.

Another study (Chen & Yang, 2015) observed that “Indoor thermal comfort and daylight access are two major concerns of building occupants, as they spend about 80% to 90% of the time on indoor activities”. Added to this study is the fact that natural ventilation is an effective sustainable design strategy that can promote indoor air quality, thermal comfort, lighting comfort and energy efficiency as observed by many researchers.

The paper suggests that there is a distinction between thermal comfort responses in air-conditioned vs. naturally ventilated buildings. It suggests that an emerging need of adaptive factors for thermal comfort may influence results of one’s thermal experiences and expectations. Observation of the measured and simulated data showed that students were within the Psychrometric Chart comfort zone as defined by dry bulb temperature and humidity. The primary difference between the three comfort models, namely California Energy Code, *ASHRAE Standard-55* PMV/PPD, and Adaptive model was the length of comfort hours. The adaptive model was the longest. Different comfort models have a different effect on the number of hours that fall within the comfort zone.

4.0 CONCLUSIONS AND LESSONS LEARNT

Adaptive models can help to make architectural design and energy-efficiency decisions. Such decisions must integrate thermal comfort, lighting and energy efficiency. When people are able to adjust their surroundings for adaption, they tend to be comfortable at wider ranges. There is mounting evidence (Humphreys, 1996; Karyono, 2000) that suggests that thermal perceptions are affected by factors that are not recognized by current ASHRAE comfort standards in naturally ventilated spaces. Hence, this study is one in a series aimed to try to answer and explain some of the factors. Comparing the measured data gathered by instruments and questionnaire with simulated data gathered by software and formulae shows that predicting thermal comfort sensation of occupants in the academic building may not always be accurate. Measured data provided a better more complete perception of responses than those simulated.

ACKNOWLEDGMENTS

The author acknowledges with much gratitude the grant support of HMC Designing Futures Foundation (DFF), 3546 Concourse, Ontario, CA 91764 (909) 989-9979 without whose help this study would not have been done. Thanks are also extended to the students, faculty and staff at California Baptist University College of Architecture, Visual Arts and Design.

REFERENCES

- ASHRAE. 2021 Handbook of Fundamentals. Atlanta, GA: American Society of Heating, Refrigerating and Air Conditioning Engineers, 2021.
- California Energy Commission. Building Energy Efficiency Standards for Residential and Non-residential Buildings for 2019, Title 24, Part 6 and associated Administrative Regulations in Part 1. California Energy Commission, CEC-400-2018-001-CMF. December 2018.
- Chen, Kongxi ; Yang, Hongxing. 2015. “Combined thermal and daylight analysis of a typical public rental housing development to fulfil green building guidance in Hong Kong” in *Energy and Buildings*, 2015:420-432. Elsevier Science.
- De Dear, Richard J. and Gail Brager. 2001 "The Adaptive Model of Thermal Comfort and Energy Conservation in the Built Environment," R. de Dear and G. Brager, *Int J Biometeorol* 45: 100-108, 2001.
- de Dear, R.J., and G.S. Brager. 1998. Developing an adaptive model of thermal comfort and preference. *ASHRAE Technical Data Bulletin* 14(1):27-49.
- Fanger, Polv O. *Thermal Comfort: Analysis and Applications in Environmental Engineering*. Copenhagen: Danish Technical Press, 1970.
- Givoni: *Man, Climate and Architecture*, Second Edition, Baruch Givoni, Elsevier, New York, 1976.
- Givoni: *Passive and Low Energy Cooling of Buildings*, Baruch Givoni, Van Nostrand Reinhold, 1994.
- Humphreys, M., and J.F. Nicol. 1998. Understanding the adaptive approach to thermal comfort. *ASHRAE Technical Data Bulletin* 14(1):1-14.
- Huntington, Ellsworth. *The Human Habitat*. New Jersey: D. Van Nostrand Company, 1927.
- Mohamed, Sherif, and Korb Srinavin. "Forecasting labor productivity changes in construction using the PMV index." *Science Direct* 35, no. 4 (2005): 345-351.
- Nishi, Y. 1981. Measurement of thermal balance of man. In *Bioengineering Thermal Physiology and Comfort*, K. Cena and J.A. Clark, eds. Elsevier New York. pp29-39
- Olgay, Victor. *Design with Climate*. 2015. New Jersey: Princeton University Press, 1963.
- Rohles, F.H., Jr. 1973. The revised modal comfort envelope. *ASHRAE Transactions* 79(2):52.
- Rohles, F.H., Jr., and R.G. Nevins. 1971. The nature of thermal comfort for sedentary man. *ASHRAE Transactions* 77(1):239.
- Van Hoof, Joost, and Jan Hensen. "Quantifying the relevance of adaptive thermal comfort models in moderate thermal climate zones." *Building and Environment* 42, no. 1 (2007): 156-170.
- Sandeep, Kota; Haberl, Jeff S; Clayton, Mark J; Yan, Wei. 2014. "Building Information Modeling (BIM)-based daylighting simulation and analysis" in *Energy and Buildings*, Elsevier Science 2014. pp. 391-403.
- Szokolay, Steven. 2008. *Introduction to Architectural Science*. University of Oxford Press, UK: Elsevier.

Nature-Based and Hybrid Infrastructures to Build Resilient Cities through the Rivers: Two Case Studies in Addis Ababa (Ethiopia)

Ruben Garcia Rubio¹, Ryan J. Green¹, Sonsoles Vela Navarro¹

¹Tulane University, New Orleans, LA

ABSTRACT: The city of Addis Ababa has experienced rapid urbanization over the past half-century. Its population has boomed to over four million residents. In contrast, its supporting systems have not caught pace with its rapid growth, and in many places is completely lacking the infrastructure to support its residents. This situation has led to rapid pollution of the city's network of rivers and deteriorated its ecologies. In working to address the needs of its growing population, the city must focus its resources on rehabilitating its natural systems and using the occasion to create hybrid infrastructures as an opportunity to resolve multiple urban issues related to its growth. This paper analyzes two sustainable infrastructures that use the rivers and their associated ecologies as their primary design component. The recently opened Zoma Museum assists in educating the population on the importance of valuing the environment and traditional techniques that are beneficial to their ecosystems. Similarly, the theoretical proposal for a Neighborhood Resiliency Center provides a potential model for a scaled intervention of the city waste management issues that are simultaneously extended into multiple socio-cultural functions for the citizens. Both serve as examples of how new nature-based and hybrid infrastructures can help build more resilient cities.

KEYWORDS: Addis Ababa, Climate Change, Resilient Urbanism, Sustainable Infrastructure, River Management

INTRODUCTION

Rivers have played a crucial role in human settlements since immemorial time. From the Tigris and Euphrates to the Nile, the Tiber, the Pearl, or the Mississippi River allowed being founded and growing some of the most significant human settlements (Kummu et al. 2011). These river networks have been used for basic needs such as water supply or sanitation but also to stimulate transportation, commerce, industry, or, more recently, recreation (Adeloye 2009; Jordaan 2009; Fang et al. 2018).

However, when the initial human settlements become significant entities, and their urbanization process accelerates, the relationship with the water bodies changes (United Nations 2008; Grimm et al. 2008). The rapid growth of many cities has not kept pace with the development of their infrastructures. In these cities, a common consequence is the pollution of their water bodies. Over time, contamination of many rivers rises to undesirable conditions and the quality of the water in the cities becomes a significant issue for public health (Parker 1936, Ren 2014). Ethiopia's capital, Addis Ababa, is currently experimenting with a comparable situation.

Addis Ababa has almost doubled its built area and population in the last five decades -and counting (United Nations 2019, UN-Habitat 2017). However, the city's rapid growth has not been accompanied by developing the infrastructures needed to accommodate the population's basic needs. Nowadays, the tangle of water bodies, once the proud frontline of the city and reason for its settlement, has been relegated to a mere open sewer where the city throws its waste and, consequently, fosters a vicious circle (Garcia Rubio and Scott 2020b).

This paper unfolds two examples to show how to convert Addis Ababa into a more adaptive city through urban and architectural design which is based on its ecologies. The first section analyzes the current relationship between the city and its rivers and highlights the leading causes of pollution of the water bodies. Next, two specific interventions will be described in detail: the recently inaugurated Zoma Museum and a theoretical proposal for a Neighborhood Resilience Center. Together, they will show how designing hybrid nature-based infrastructures for the rivers can improve not only a city's ecologies but also its resilience.

1.0 ADDIS ABABA AND RIVER POLLUTION

Addis Ababa does not have one large river but a tangle of many small rivers and streams. In fact, its foundation was intimately related to water bodies. The existence of some hot springs on the slope of the Entoto Mountains, and the fertile soil produced by the number of rivers, encouraged Emperor Menelik II and Empress Tauti to move the military camp from the inhospitable and hardly accessible peak to a warmer and more productive location in the late 19th Century (Sellassie 1931, Pankhurst 1961). Nonetheless, the city has turned its back on the water bodies over time, despite its historical and physical relationship.

Currently, Addis Ababa is experimenting with unprecedented levels of river pollution (Centre for Environmental Science, Addis Ababa University 2017). An incomplete and obsolete sewage network, an inadequate solid waste management system, domestic organic matter discharge, industrial leakage wastes, agricultural and washing outflow are among the most common waste sources in the city (Figure 1 & 2).

The sewerage system for the city is extremely undersized or non-existent in certain areas. Currently, the city operates two central wastewater treatment plants, the Kality and Kotebe. Kality treats the piped sewer lines for the city and the Kotebe facility is responsible for sludge collection from the city's open pit latrines (Teklu 2012). As reported by Addis Ababa University for the city's government: 64.8% of the population are using pit latrines, 13.1% have no sanitation facilities at all, and 22.1% have flushable toilets. Average annual wastewater production is 851 tones while only 12% of this is collected and treated by the city's system (Centre for Environmental Science, Addis Ababa University 2017). Most of the system is open air trenches and the vast majority of both trenched and piped sewerage empties directly into the river network, effectively turning it from a water source into a sewer line.

The solid waste management system experiences a similar situation of undersized infrastructure. As reported by the city's Water and Sewerage Authority (SWA) in 2010, 76% of solid waste within the city comes from households with each of the over 3 million residents estimated at creating 0.4 kilograms per day with over 200,000 tons being collected each year (UN-Habitat 2017). The remainder of waste comes 18% from institutions such as commercial facilities and hotels and the remaining 6% collected by the city is from street sweeping. Of all being collected, it has been reported that 60% is organic in nature and 15% is recyclable (UN-Habitat 2017). It has been estimated that 65% of the solid waste generated within the city is collected by the SWA, 5% is recycled, and 5% is composted. The remaining 25% is dumped onto unoccupied urban lots, drainage channels, streets, and directly into the city's rivers (Community Development Research 2011). In addition, more than 12% of households have been reported to dump their waste on the streets or vacant plots (UN-Habitat 2003).



Figure 1 & 2: Urban and river pollution in Addis Ababa. Source: (Author 2019)

Fertilizer and livestock runoff from urban farming operations is also being continuously discharged into the city's waterbodies (Centre for Environmental Science, Addis Ababa University 2017). Major crops that support the population of Addis Ababa are irrigated with polluted water from the river network as they are located downriver from the city (Teklu 2012). Agricultural runoff from the excessive use of nitrogen and phosphorous results in eutrophication, growth of algae and weeds that deplete oxygen in the water that then affects aquatic flora and fauna (Centre for Environmental Science, Addis Ababa University 2017). Moreover, Addis Ababa contains more than 2500 industries and more than 90% are

noted to illegally dump their wastewater into the river network, further contributing to the existing sewerage problems the system is experiencing (Centre for Environmental Science, Addis Ababa University 2017). Runoff from the urban environment flowing into rivers is carrying construction debris, sediments, plastics, and other domestic wastes (Edessa 2017).

The city requires infrastructural improvements that will not only meet the needs of the growing population, but that can also mitigate the pollution currently seen throughout the city. Systems which focus on natural processes will be beneficial in attracting the population to embrace new infrastructure and to play a part in the remediation of the city's polluted land and waters.

2.0 ZOMA MUSEUM, A SOCIOCULTURAL ECO-INFRASTRUCTURE

Zoma Museum was founded by anthropologist and art curator Meskerem Assegued and artist Elias Sime in Addis Ababa. The museum officially opened in 2019, but its history began in 2002 as a collaboration to form a contemporary art center (Zoma Museum. n.d.). Over the next decade, the institution began purchasing land in Mekanisa, with the acquired lot being described as a "very dirty and fetid farmland" area (Assegued, Email to authors, October 2021). It is adjacent to the Akaki River located in the south-west part of the capital and sits on two acres of land (GFHS 2020). The complex contains several constructions flanked around a central gallery, including a school, library, restaurant, amphitheater, and botanical and urban garden. Place and program encouraged the founders to envision an eco-sensitive art institution involving art production, architecture, and landscaping, with specific research being on timeless vernacular forms which are traditional to the region and its climate (Berlanda 2020). This statement is clearly exposed in both the landscape spaces and the buildings.



Figure 3: Canals and planting of the Zoma Musuem. Source: (Author 2019)

Figure 4: The chikka architecture and wall designs of the Zoma Museum. Source: (Author 2019)

The location played a crucial role in the confirmation of the institution's statement. The proximity to the river and the sloped topography made the final plot prone to receive polluted water outpouring from the upper part of the neighborhood. As "we [Zoma Museum] are located on the lower side of the city, all kinds of water come through our compound, including sewage," state the founders (Assegued, Email to authors, October 2021). That is why the central concept behind the development of the exterior spaces was the conjunction of a significant green area with channels to collect, clean, and reuse the water.

Remediation of the site was the first step. Existing weed and grass vegetation was removed from the fetid land, and careful consideration was taken to keep existing indigenous and endemic plants and trees. In this process of cleaning the earth, the team discovered buried solid waste on the site, which was removed. All unused vegetation was burned, and the ashes were used as fertilizer for the new growth planned for the site, including herb, vegetable, and flower gardens (Assegued, Email to authors, October 2021).¹

Once the land was clean and ready to plant again, the founders developed the new landscape. The exterior spaces are designed with the site's natural slope in mind, across several levels terraced with dry stone walls with cobblestone walkways and utilize a gravity-fed irrigation system through a series of meandering canals (Figure 3). In the collection process through the channels, the polluted water is naturally cleaned through vegetation (reeds), sand sediment filters, and exposition to the sun before it enters the cultivated gardens. Rainwater is also collected in the buildings and the exterior spaces through this canal system to reuse it or channel back into the river for ease of drainage (GFHS 2020). This triple-action (collection, cleaning, and reusing) gives the channels a key role in the sustainable design of the compound by rooting it in both the context and the tradition.

Similarly, the symbiosis between art, architecture, and nature, is exposed in the construction of the main buildings (Figure 4). As Assegued and Sime sought to focus the design on vernacular techniques traditional to Ethiopia, they decided on construction technique for the buildings was a form of waddle and daube called *chikka* (Mattioli 2019). This traditional technique is an ancient -and nearly universal- construction form which consists of a wooden frame with stick latticework between the vertical frame members, which is then covered in a mud and fiber mixture. *Chikka* specifically utilizes a bamboo frame that is held together with strings with an on-site sourced mud and straw mixture. This construction form has the benefit of being environmentally sound, with all resources used in producing the structure able to be taken from the immediate site, and the construction helping to naturally regulate the internal temperature.

Also, the setting process required by the mud used in the construction had the additional benefit of being a canvas used for artistic expression. Sime was able to form diverse designs into the facades of the various structures with different meanings within each design, such as the winding line and fingerprint pattern of the main gallery that expresses the experienced difficulties of the project's builders (Berlanda 2020). The Zoma Museum confirms the abilities of traditional practices of construction and landscape design as resilient and environmentally friendly, plus it actively works to better the ground it sits on and the community that uses it. In addition, its various components come together to inform of Ethiopia's culture and promote the ability of its citizens to create a better future for their city and country.

3.0 A NEIGHBORHOOD RESILIENCE CENTER

The Neighborhood Resilience Center is a theoretical proposal for Addis Ababa. This design is part of the academic research project "Addis Ababa River City," whose main aim is to design a holistic urban resilience strategy for Ethiopia's capital by using the river network as a catalyst for urban regeneration.ⁱⁱTo do that, the proposal is based on the multi-level analysis of the current city-state developed by the research project and is inscribed in the sustainable infrastructure proposed for the Upper Kebena river area (Garcia Rubio and Scott 2020a). This infrastructure is designed under three main perspectives: ecology, the recovery of river and riverbanks; connectivity, the creation of longitudinal and transversal mobility networks; and, opportunity, the promotion of points of interest to activate different zones. The Neighborhood Resilience Center intertwines the three perspectives above mentioned as part of its design (Figure 5).

Through an analysis of the city's existing conditions, an initial catalyst was identified as the lackluster performance of the waste management system. As partially outlined previously in this paper, the system operates extremely inefficiently with its gaps leading to a buildup and backlog of solid waste throughout the city. Resulting from this backlog, the population has resorted to open burning of trash and creating informal landfills at unoccupied land. This condition of unoccupied land exists most prominently along the river network.

Currently, the city waste management system is organized as a centralized tiered system with primary and secondary components. Primary collection occurs at the neighborhood level by a series of micro enterprises that hold contracts with the government. Each contractor is assigned a zone of 800 to 1000 households. In total, there are over 500 recognized contractor enterprises representing over 5800 individuals employed in the field. These neighborhood contractors bring waste to designated collection points where the 10 sub-city governments collect the waste for relocation to the central Koshe landfill and Repi waste to energy facility. The Koshe / Repi facility is a 25-hectare plot and is the only central collection point for the city (UN-Habitat 2017). Repi opened in 2018 with the potential to supply 30% of the city's households with power (Scott 2018). However, it has not operated properly since its inception due to the high volume of organic waste collected which is not suitable for the incineration process required in traditional waste to energy facilities. The facility, while being the central plant for the city, was only designed to meet 50% of the daily waste collection which will only serve less and less with the amount of population growth the area is experiencing (Alemu 2019).



1. Entry Court
2. Solid Waste Sorting
3. Biogas Energy Facility
4. Water Treatment & Filling Station
5. Planting Bed
6. Rest Room
7. Storage
8. Gathering
9. Market
10. Roof Access
11. Classroom
12. Natural Water Treatment
13. Riverfront Seating
14. Fresh Water Intake
15. Recreational Path

Figure 5: Proposed Neighborhood Resiliency Center Plan. Source: (Author 2021)

From this understanding of the current inadequacies of the system, a replicable intervention is required to create a decentralized waste management system that can scaled with the growth of the city. It needs to address the issues of waste and pollution close to citizens homes and to eliminate the practice of open dumping and burning to help protect the health of citizens and the areas ecology.

Moving away from the city scale model of the centralized waste management system is a proposed solution to the waste management issue within Addis Ababa. Having collection and processing at the neighborhood level provides several benefits to both the city and its constituent neighborhoods. Localizing the system has the benefit of maintaining the employment of the city's micro enterprise solid waste collectors and removes the inefficiencies at the city level that have resulted in buildup of waste and a lack of collection throughout. Citizens will be within walking distance of a resiliency center that serves not only to stem the causes of pollution outlined before, but to create a site that embodies the goals of ecology and connectivity. The site gives back to the community through both its inputs and outputs, assisting in encouraging its use by and making it a central node of the neighborhood.

The design separates the forms of waste to best take advantage of their disposal process and create useful outputs where available. As noted previously, the city's solid waste is highly organic in composition. To take advantage of this, each resiliency center will process organic waste through the primary program of a biogas waste to energy plant. Here, organic waste collected from the neighborhood is allowed to decompose in tanks where the biproduct of methane is collected for use in electrical production for all programs on site. The remains of the organic waste after methane harvesting are then used on site or sold to local farmers as a natural fertilizer and soil. Agricultural beds on site directly adjacent to the biogas structure allow for immediate use to produce crops for the community. At the entry court to the biogas building, separate dumpsters are meant for the collection of inorganic waste, which will be collected by the city and properly processed at the Repi Waste to Energy plant.

Choosing a site along the Upper Kebana river creates an opportunity to provide water treatment to the currently polluted river and to gain water for both the agricultural programs on site and the community that uses it. Directly at the river, a separate filtration channel is created that moves water through rubble, sand, and aquatic plant sections to naturally remove harmful elements from the water. From here water is pumped from the Upper Kebana river to the site above where it is channeled to irrigation channels and a treated bottle filling station. Like the Zoma Museum, the irrigation channels are further able to filter water before it is used on the agricultural beds. The water treatment building allows for users of the site to fill bottles for individual and home use and provides a return service to those who bring their waste to the site (Figure 6).

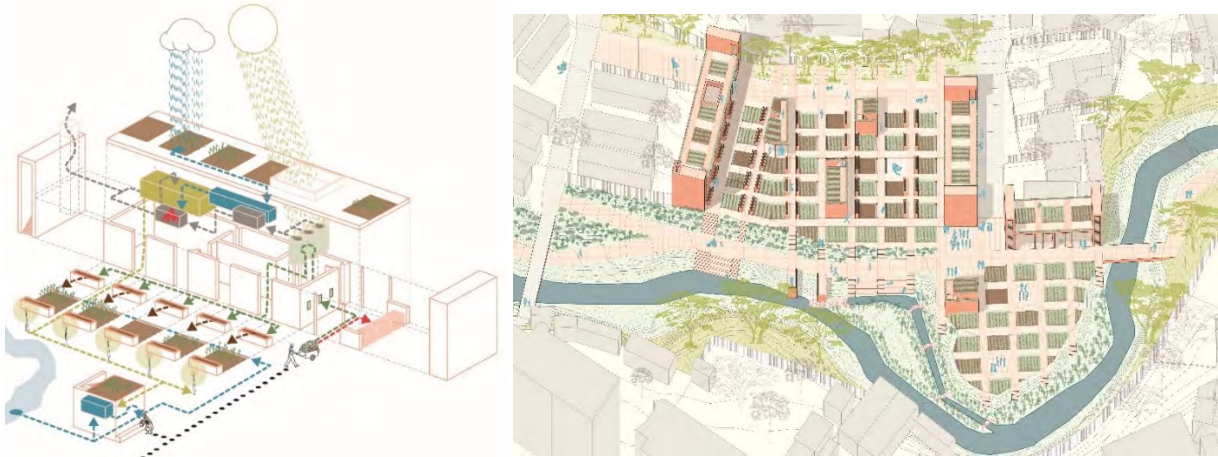

Figure 6: Neighborhood Resiliency Center System Diagram. Source: (Author 2020)

Figure 7: Neighborhood Resiliency Center Rendered View. Source: (Author 2020)

To further incentivize use by residents, secondary programs which also provide services to the community are incorporated. Including a covered market that allows for the produce grown on site to be directly sold to users and welcomes other neighborhood vendors to participate in a central market point. A riverfront trail provides recreational and connective opportunities to residents and refocuses attention on the city's river network. On site walking paths and gathering spaces weave through the agricultural beds and encourage people to stay on the site and to explore the natural reuse and water purification processes in action. Educational classrooms provide space for deeper understanding in the topics of reuse and further service as community support spaces. Each of these programs both provide necessary services to each resident of the zone the neighborhood resiliency center serves and encourages them to be active participants in creating a cleaner urban environment. Waste produced by the community is reframed from being a health hazard and pollution source into playing an integral role in the vitality of the area (Figure 7).

CONCLUSION

The Thames River was once used as an open sewer channel until the cholera epidemic in the 19th Century forced the city of London to create a modern sewage system to avoid the spread of the illness (Mann 2016). Nowadays, with increasing rates of climate change impacting populations across the globe, it is important for designers to rethink our cities infrastructures and the processes they utilize. Designers should also understand complex issues such as urban pollution, population growth, and the state of systems to create new, more resilient urban infrastructures and should act before being forced to do so by major cataclysmic events. Understanding the state of Addis Ababa, it is easy to see that the city is near a breaking point with its current urban systems. Continued growth will only further overwhelm its infrastructure and lead to greater pollution of its environment. There is, however, great potential to enact environmentally sound, nature-based infrastructure techniques to remediate its environment and to encourage its population to participate in creating a better, more resilient, urban condition.

As shown in the Zoma Museum, utilizing an intentionally designed landscape can revitalize polluted land and create a productive landscape for their population. Natural filtration processes can be implemented with the benefit of minimizing physical pollution into river networks and not requiring any human made high energy mechanical treatment processes. Similarly, the Neighborhood Resiliency Center proposal examines the potential of decentralized infrastructure for the benefit of rapidly growing populations and through an understanding of the existing makeup of the city's waste uses natural decomposition process of mainly organic nature of Addis Ababa's waste to create positive outputs to the community. It also utilizes natural water filtration techniques to supplement its agricultural program with other secondary programs to incentivize the sites use by residents. Its highlighting of natural processes fosters community education and participation in the solid waste regeneration and leads to an embracing of infrastructure as a node of community engagement.

Both cases studies show that there is a significant opportunity to utilize nature-based processes to minimize energy requirements and pollution outputs into the environment. The use if hybridized nature-based infrastructures have the potential to reframe the internal workings of cities all across the globe and make them more resilient and sustainably adapted to their environments.

REFERENCES

- Alemu, F. 2019. *Why Reppie Waste to Energy Project Failed*.
https://www.academia.edu/38236139/Why_Reppie_waste_to_energy_plant_project_falled
- Berlanda, T. 2020. "Ground Control: The Zoma Museum by Meskerem Assegued and Elias Sime." *The Architectural Review*, no. 1468 (February). <https://www.architectural-review.com/buildings/ground-control-the-zoma-museum-by-meskerem-assegued-and-elias-sime>
- Centre for Environmental Science, Addis Ababa University. 2017. Addis Ababa City Rivers Pollution and Sanitation Study. Addis Ababa, Ethiopia: Addis Ababa Rivers and Riversides Development and Climate Change Adaptation Project Office, Addis Ababa City Administration.
- Community Development Research. 2011. "Ethiopia Solid Waste & Landfill – Country Profile and Action Plan." *Global Methane Initiative*. Global Methane Initiative.
https://www.globalmethane.org/documents/landfills_cap_ethiopia.pdf
- Edessa, A. 2017. Riversides Urban Landscape Character Assessment and Proposal. Addis Ababa, Ethiopia: Addis Ababa Rivers and Riversides Development and Climate Change Adaptation Project Office.
- Fang, Y., et al. 2018. "Globally Universal Fractal Pattern of Human Settlements in River Networks." *Earth's Future* 6, no. 8: 1134–1145.
- Garcia Rubio, R. and Taylor J. Scott. 2020a. "Resilient Urban Ecologies: Adaptive Sustainable Infrastructures for Addis Ababa." *The Plan Journal*, vol. 5, no. 2 (December): 473-94.
<https://www.theplanjournal.com/article/resilient-urban-ecologies-adaptive-sustainable-infrastructures-addis-ababa>
- Garcia Rubio, R. and Taylor J. Scott. 2020b. "Designing for Sustainable and Resilient Neighborhoods: The Case of Peacock Park in Addis Ababa (Ethiopia)." In *2020 AIA/ACSA Intersections Research Virtual Conference: Carbon*, edited by Corey T. Griffin and Erica Cochran Hameen. Washington: ACSA Press.
- Grimm, N. B., et al. 2008. "Global Change and the Ecology of Cities." *Science (American Association for the Advancement of Science)* 319, no. 5864: 756–760.
- GFHS. 2020. "Zoma Museum: A Role Model of Connecting Art and Sustainability." Zoma Museum: A role model of connecting art and Sustainability. Global Forum on Human Settlements, July 1, 2020.
http://www.gfhsforum.org/content?article_id=575&cwbolw=kbni3
- Mann, E. 2016. "Story of Cities #14: London's Great Stink Heralds a Wonder of the Industrial World." *The Guardian*. *Guardian*, April 4, 2016. <https://www.theguardian.com/cities/2016/apr/04/story-cities-14-london-great-stink-river-thames-joseph-bazalgette-sewage-system>.
- Mattioli, G. 2019. "Addis Ababa's First Contemporary Art Museum Aims to Revive a Local Architectural Tradition." *Metropolis*, January 22, 2019. <https://metropolismag.com/projects/addis-ababa-zoma-museum-design/>
- Pankhurst, R. 1961. "Menelik and the Foundation of Addis Ababa." *The Journal of African History* 2, no. 1: 103-17;
- Parker, A. 1932. "Water Pollution Research." *Nature* 130, 761–763. <https://doi.org/10.1038/130761a0>
- Ren, H., et al. 2015. "Association between Changing Mortality of Digestive Tract Cancers and Water Pollution: A Case Study in the Huai River Basin, China." *International Journal of Environmental Research and Public Health* 12, no. 1: 214-226. <https://doi.org/10.3390/ijerph120100214>
- Scott, K. 2018. "Waste-to-Energy Plant to Take on Ethiopia's Rubbish Epidemic." *CNN World*, August 21, 2018.
<https://www.cnn.com/2018/08/21/africa/reppie-waste-to-energy-addis-ababa/index.html>.
- Sellassie, G. 1931. *Chronique du regne de Menelik II, roi des rois d'Ethiopie*. Paris: Maisonneuve Frères.
- Teklu, S. 2012. *Wastewater Production, Treatment and Agricultural Use in Ethiopia: The Case of Addis Ababa City*. UN-Water, n.d.
https://www.ais.unwater.org/ais/pluginfile.php/231/mod_page/content/188/ethiopia_country_report.pdf.
- Tigabu, T., and Semu, G. 2008. *Ethiopia: Addis Ababa Urban Profile*. Nairobi, Kenya: United Nations Human Settlements Programme.
- UN-Habitat, 2003. *Urban Inequities Report: Addis Ababa*. Nairobi: UN-Habitat.
https://mirror.unhabitat.org/downloads/docs/9173_97089_Addis_AbabFinal.pdf
- UN-Habitat. 2017. *The State of Addis Ababa 2017: The Addis Ababa We Want*. Nairobi: UN-Habitat.
- United Nations, Division of Sustainable Development. 2010. Overview of Addis Ababa City Solid Waste Management System. New York: United Nations.
https://www.un.org/esa/dsd/susdevtopics/sdt_pdfs/meetings2010/icm0310/2b-2_Tessema.pdf.
- United Nations, Division of Population, 2019. *World Population Prospects 2019 Online edition, rev.1*. New York: United Nations. <https://population.un.org/wpp/Download/Standard/Population/>
- Zoma Museum. n.d. "Zoma Museum." Zoma Museum. <https://www.zomamuseum.org/zcac-addis-2.html>.

ENDNOTES

ⁱ “The fruits trees include, pomegranate, fig, apple, orange, lemon, avocado, banana, papaya, zeytuna, etc. Vines including: pepino, passion fruit, chawchaw, nasturtium etc. The vegetable include kale, spinach, green, salad, tomato, potato, carrot, lick, onion, garlic, ginger etc. The herbs include: iritzia, rosemary, lemon, verbena, mint, paper-mint, rue, thyme, damakese, basil, cardamom, lippia abyssinica (Koseret), bay leaves etc.” Meskerem Assegued, Email to the authors in October 2021.

ⁱⁱ The "Addis Ababa River City" research project is an independent, multidisciplinary, and long-term progra

Social Scorecard: A Comprehensive Social Health Analysis Tool

Edgar Stach¹, Summer Koch¹

¹Institute for Smart and Healthy Cities, Thomas Jefferson University, Philadelphia, PA

ABSTRACT: Smart and Healthy Cities, an emerging focus within urban planning strategies, refers to a conceptual framework of incorporating sensor-driven data collection technologies in the continual process to improve the health of its citizens (Stach 2021). Derived from this conceptual framework and understanding that investments into the urban environment, driven by economic constraints, are developed through targeted social health outcomes in isolated sectors, Social Scorecard investigates the Social Determinants of Health (SDOH) within urban environments to understand their impact on the human condition. Social Scorecard aims to create a parametric model capable of communicating the holistic impact of proposed social health intervention strategies. Social Scorecard goals include: (1) integrate various data streams providing social health data into a single analytic engine, (2) create of visual analytic maps to understand social health risk zones, (3) encourage the development of holistic intervention strategies, (4) predict the impact of social intervention and investment projects, and (5) utilize this tool as an effective teaching resource for academic programs as well as a means to assess the impact of design and infrastructure changes before implementation for community and city leaders. The research and project outcome is the creation of a comprehensive scorecard framework to evaluate the health of urban social health conditions. This framework focuses on Philadelphia, Pennsylvania and outlines possible pilot project solutions for conversion into a model Smart and Healthy City.

KEYWORDS: social health + urban environments; social determinants of health; equity + the built environment; information + communications technology

Introduction

Urban land in the coterminous United States is projected to nearly triple from 3.1% in 2000 to 8.1% in 2050 with most of the urban growth projected to occur around the more heavily urbanized areas (Nowak and Walton 2005). This rapid urbanization, driven by economic growth and employment opportunities, aging infrastructure, and the effects of climate change highlight how the evaluation of social health is crucial to public wellbeing. Through the development and implementation of holistic urban investment strategies, cities could create more pleasant environments while also reducing associated health risks for their residents. Smart growth, with a focus on clean and sustainable transport, higher energy efficiency and social cohesion has the potential to contribute to healthier cities and create a smart, sustainable, and inclusive economy, reducing differences in health outcomes and life expectancy by making positive changes that affect the entire community (Sotres 2017). Combining the Smart City and Healthy Cities Approach urban planning ideologies, Smart and Healthy Cities aims to standardize the integration of technological systems to promote the health of its citizens; the Smart and Healthy Cities conceptual framework presents the opportunity for a holistic evaluation of the social health for community members within a selected urban environment.

Smart City refers to a city with a focus to become self-aware through measurement and monitorization of data; often achieved through the integration of sensor-driven data collection and powerful analytics are used to automate and orchestrate a wide range of services in the interest of better performance, lower costs and lessen environmental impact (American Society of Landscape Architects 2021). Smart cities utilize information and communications technology (ICT) in three main capacities to enhance livability, workability, and sustainability directly for citizens throughout the region and indirectly for the overall human population. The first use of ICT throughout a Smart City is to collect data about itself by installing sensors or other devices or updating existing interconnected systems to detect information; this data is then communicated through wired or wireless networks for analysis to document current conditions and predict future outcomes. The incorporation of ICT into the fabric of a Smart City strengthens our ability to understand human impact on our natural environment and how we may exploit technological advancements to be a Healthy City.

Healthy Cities are defined by the continual process and commitment to improve the health of its citizens; a healthy city is one that continually creates and improves physical and social environments while expanding the community resources which enable people to mutually support each other in performing all the functions of life and developing to their maximum potential (WHO Regional Office for Europe). Remaining conscious of public health conditions and striving to improve them, a Healthy City is required to demonstrate their commitment to health by implementing a transparent process and structure to achieve their goals. The Healthy Cities Approach seeks to place public health high on the political and social agenda of cities and build a strong movement for public health at the local level (WHO

Regional Office for Europe). The Healthy Cities Approach recognizes the determinants of health and the need for collaboration across all public, private, voluntary and community sector organizations strongly emphasizing equity, participatory governance and solidarity, inter-sectoral collaboration, and action to address the determinants of public health. This process entails explicit political commitment, dedicated leadership, institutional reform, and inter-sectoral partnerships (WHO Regional Office for Europe). Successful implementation of the Healthy Cities Approach requires innovative action addressing all aspects of public health and living conditions in tandem with extensive networking between cities. This collaborative approach includes involvement by local people in decision-making, requires political commitment, organizational and community development, and recognizes the process to be as significant as the outcomes.

The Social Determinants of Health (SDOH) are defined as the conditions in the places where people live, learn, work and play that affect a wide range of health risks and outcomes within the interrelated social structures and economic systems that shape these conditions (*Determinants of Health 2017*). These indicators include aspects of the social, economic, and physical environment, in addition to individual characteristics and behaviors, which are vital to an accurate analysis of a community's social health. These SDOH indicators serve as the data items within their respective sectors to create a holistic evaluation of chosen urban environments. A holistic evaluation of social health, through the development of this social scorecard rating system, is critical for the future development of equitable, healthy, and social urban environments.

1. Social Scorecard Overview

Vision: Transform urban environments into healthy, social communities.

Mission: To create an accessible and equitable means of analyzing the social health of cities for targeted social intervention strategy investments.

The following criteria act as a framework in determining whether a city can be classified as a Smart City, developed based on previous research. Determinants for a Smart and Healthy City include:

1. Utilization of infrastructure to collect data and/or communicate information
2. Incorporation of collected data into city-, infrastructure-, and policy-planning
3. Increase human quality of life in aspects of ease/convenience, access to common resources, health, personal security, and beauty of surroundings
4. Detection and communication of environmental and personal security risk factors
5. Elimination of pollutant emissions or reversal of pre-existing and future damage caused by pollution
6. Adaption and incorporation of natural processes to maximize city potential for prosperity as witnessed through increased ease/convenience, health, beauty of surroundings, and personal security
7. Conservation and management of resources to eliminate or address environmental risk factors

What is this project trying to accomplish? The creation of a comprehensive scorecard to describe the social health of a community within a selected urban environment. Using data relevant to the city of Philadelphia, Social Scorecard aims to build a comprehensive and collaborative engine across disciplines to assess the social health status across any city given the proper criteria. This engine would provide a holistic understanding of the interrelationship between indicators of urban social determinants of health, presenting opportunities for social intervention strategies, through the creation of layered heat maps highlighting social health risk zones throughout the chosen urban environment.

Why are we trying to accomplish this? A comprehensive matrix scorecard could be leveraged to evaluate opportunities for community and city officials by presenting a variety of solutions capable of providing a desired outcome. Clear visuals overlaying social health indicator data provide clear zones of high social risk, possible plans for action, a timeline and investment possibilities for confronting the various social determinants. Enabling community members and city officials across all disciplines to comprehend social health data encourages local involvement within policy- and investment-making decisions to maximize potential community benefits because of investment funds. These comprehensive graphics would empower local governments and community leaders to develop holistic solutions to social health risks as opposed to the traditional methodology of studying social health indicators within isolated sectors.

How does this project plan to do this? Connecting all SDOH indicators into a singular parametric model capable of visualizing overlaid information, the integration of data sets across a variety of public, private, and academic disciplines empowers users to indicate communities within an urban environment in need of social health intervention and analyze the impact of investment strategies before implementation. The integration of these SDOH indicators as data sets within a parametric matrix would generate graphics communicating existing social health conditions, which could be further manipulated in response to proposed intervention solutions. This synthesis of knowledge of disciplines currently studied in isolation allows for a cross-disciplinary approach towards city investment and development.



Social Scorecard would include sectors of the following SDOH sectors, further discussed within this proposal:

1. Housing
2. Transportation and Mobility
3. Economic Wellbeing
4. Crime and Violence
5. Social Support and Social Context
6. Food and Agriculture
7. Healthy Literacy
8. Environmental Health
9. Population Demographics
10. Energy Consumption
11. Retail and Restaurants

Case Studies

Healthy Streets Approach for London. The Healthy Streets Approach, adopted by the Mayor and Transportation for London as a result of recognizing an inactivity crisis within the population of London, refers to the system of policies and strategies to encourage London citizens to use cars less and walk, cycle and use public transport more. Having identified active travel – walking, cycling, or using public transportation – as providing the easiest and most affordable means of increasing the general public’s activity and health, key targets for implementation of the Healthy Streets Approach include: (1) increase the number of trips made by “sustainable modes of transport” (walking, cycling, car share, and public transportation) to 80% by 2041; (2) for all London citizens to undertake the 20 minutes of daily active travel as recommended to stay healthy by 2041; (3) realization of Vision Zero (a plan for the elimination of all death and serious injuries within London’s transport system) for road danger by 2041.

With a strong focus on investment strategies within the Transportation sector, Healthy Streets Approach also aims to improve air quality, reduce congestion, and help make London’s diverse communities greener, healthier and more attractive places to live, work, play and do business (Greater London Authority). As the Healthy Streets Approach details a long-term plan for improving the experience of London citizens and visitors while on the streets, adoption requires systemic change within three main levels of policy-making and delivery aimed towards improving the experience of traveling through and spending time on London’s streets: direct interaction through the Street Level; planning and managing London’s transport networks on the Network Level; and future policy and planning on a Strategic Level. The Healthy Streets Approach uses the following 10 evidence-based indicators listed in Table 1 to determine what makes streets attractive with a final goal to create a healthier city, in which all people are included and can live well, and where inequalities are reduced (Greater London Authority).

Table 1: Healthy Streets Approach Social Health Indicators. Source: (Greater London Authority)

Social Health Indicator	How It Is Measured
<i>Population Diversity / Pedestrians from all walks of life</i>	<i>London’s streets should be welcoming places for everyone to walk, spend time in and engage in community life.</i>
<i>Active Travel / People choose to walk, cycle and use public transport</i>	<i>Walking and cycling are the healthiest and most sustainable ways of travel, either for whole trips or as part of longer journeys on public transport. A successful transport system encourages and enables more people to walk and cycle more often.</i>
<i>Air Quality / Clean Air</i>	<i>Improving air quality delivers benefits for everyone and reduce unfair health inequalities.</i>
<i>Personal Security / People feel safe</i>	<i>The whole community should always feel comfortable and safe on our streets. People should not feel worried about road danger or experience threats to their personal safety.</i>
<i>Noise Pollution / Not too noisy</i>	<i>Reducing the noise impacts of motor traffic will directly benefit health, improve the ambience of street environments, and encourage active travel and human interaction.</i>
<i>Access to Streets / Easy to Cross</i>	<i>Making streets easier to cross is important to encourage more walking and to connect communities. People prefer direct routes and being able to cross streets at their conveniences. Physical barriers and fast moving or heavy traffic can make streets difficult to cross.</i>
<i>Places to Stop and Rest</i>	<i>A lack of resting places can limit mobility for certain groups of people. Ensuring there are places to stop and rest benefits everyone, including local businesses, as people will be more willing to visit, spend time in, or meet other people on our streets.</i>
<i>Environmental Protection / Shade and Shelter</i>	<i>Providing shade and shelter from high winds, heavy rain and direct sun enables everybody to use our streets, regardless of weather.</i>
<i>Personal Comfort / People feel relaxed</i>	<i>A wider range of people will choose to walk or cycle if our streets are not dominated by motorized traffic, and if pavements and cycle paths are not overcrowded, dirty, cluttered or in disrepair.</i>
<i>Social Attractions / Things to see and do</i>	<i>People are more likely to use our streets when their journey is interesting and stimulating, with attractive views, buildings, planting and street art and where other people are using the street. They will be less dependent on cars if the shops and services they need are within short distances, so they do not need to drive to get to them.</i>

SocialScape. Built upon extensive research compiled by the Socially Determined Foundation, SocialScape enables stakeholders to easily digest complicated data signals that comprise social determinants of health and reveals the patterns driving costs and utilization among communities and populations to deliver better outcomes. Addressing social risk at scale requires visibility to the risk impact the entire population as opposed to isolated patient groups seen by individual healthcare providers. “To act on social risk, organizations must be able to look across the populations and communities they serve and quantify impacts so they can create sustainable strategies and programs ... We help organizations understand the dynamics of social risk and create actionable programs to improve utilization patterns, reduce costs, and improve health outcomes” (Beverina 2019). Social Scorecard aims to build a similar algorithmic matrix to SocialScape capable of visualizing social risk zones within urban environments, fusing together all available data sets, and creating analytic potential intervention strategies; these potential intervention strategies would be presented through layered graphics as Social Scorecard quantifies the impact social risk has on predicted social utilization, cost and outcomes for the selected population based on clinical, economic, demographic, social, environmental, and location-based markers.

Table 2: Social Determinants of Health Indicators. Source: (Beverina 2019)

Social Health Indicator	How It Is Measured
<i>Economic Wellbeing</i>	<i>Economics lies at the heart of many problems. We look at how factors like monthly income, employment status, cost of living, access to benefits and financial security affect health and wellbeing.</i>
<i>Food Insecurity</i>	<i>Many people live in “food deserts.” For many Americans, the availability of unhealthy food far outweighs healthy food options. We look at how being without reliable access to enough affordable, nutritious food affects health and wellbeing.</i>
<i>Housing Insecurity</i>	<i>We have seen direct casual links between housing conditions and certain disease progressions. We look at how crowding and quality of dwellings within an area affect the health and wellbeing of people living there. In addition, we look at how instability in one’s housing affects health outcomes.</i>
<i>Transportation</i>	<i>This is a hot topic today in healthcare with ride-share companies like Lyft and Uber providing billions of dollars of non-emergency transport. We look at transportation grids, general availability and accessibility, and safety of transportation in neighborhoods in relation to health and wellbeing.</i>
<i>Crime and Violence</i>	<i>A wealth of research shows that exposure to violence and crime is detrimental to one’s health. We look at how the prevalence of violent and property crime in neighborhood affects health and well-being.</i>
<i>Health Literacy</i>	<i>We are looking at how the ability to obtain, read, understand, and use healthcare information to make decisions and comply with treatment affects health and wellbeing.</i>
<i>Social Support</i>	<i>This is one of the most important, complex and nuanced social determinant indicators. We look at how the availability of assistance from other people and the feeling that one is part of a supportive social network affect health and wellbeing. We also examine triggers that can often occur in a person’s life that takes them from low to high risk in an instant.</i>

Social Determinants of Health Sectors

Understanding that investments into urban communities are typically tied to outcomes within traditional research sectors, the following provides a brief description of each Social Determinant of Health sector that would be included into the matrix of Social Scorecard. Each Social Determinant of Health sector also includes a list of impacted stakeholders in conjunction with examples of direct and indirect indicators of social health to demonstrate their interconnected relationships. As analyzing the implications regarding the social health of urban environments within these sectors individually dominates current urban planning strategies, the creation of a comprehensive analytic tool will empower urban planners and local community officials to fund social intervention strategies targeted for and informed by their specific communities. Social Scorecard could be utilized in both the conceptual and analytic phase of urban development strategies by presenting community-specific data outlining the location and severity of existing social health risk zones, and to analyze the potential impact of chosen intervention strategies on their communities.

Housing. The role of housing as a social determinant of health is well-established, but the casual pathways are often poorly understood beyond the direct effects of physical housing defects. For low-income, vulnerable households there are challenges in creating a sense of home in a new tenancy which may have substantial effects on health and wellbeing (Rolfe 2020). Poor quality housing and housing instability conditions have been associated with numerous physical health conditions due primarily to poor indoor air quality, cognitive delays in children from exposure to neurotoxins, and accidents and injuries because of structural deficiencies.

Primary Stakeholders: Community Residents, Housing Authority, Education Boards, School Administrators/Teachers, Parent-Teacher Associations (PTA), Homeless Populations, Law Enforcement, Criminal Justice System, Planning Committees/Zoning Review Boards, Historical Society Members

Direct Housing Indicators of Social Health	Indirect Housing Indicators of Social Health
<i>Indoor Air Quality; Allergens and Dust Mites; Crowding Conditions; Rates of Homelessness; Reuse of Obsolete Infrastructure; Quality of Infrastructure; Home Accident Prevention; Fire Prevention; Sustainable Building Materials; Asbestos and Lead; Zoning and Building Typologies; Communicable Diseases; Household Food Security; Sewage Management and Treatment</i>	<i>Mental Health; General Health; Real Estate Property Values; Resident/Tenant Displacement; Access to Safe and Affordable Housing; Rates of Poverty; Zones of High Risk; Psychosocial Disorders; Air Pollution; Noise Pollution; Light Pollution; Water Pollution; Heat Islands; Non-Communicable Diseases; Access to Clean Water; Access to Safe and Affordable Food</i>

Transportation and Mobility. An estimated 3.6 million people in the United States annually do not obtain medical care due to transportation issues (Health Research & Educational Trust 2017); these transportation issues include factors such as: a lack of vehicle access, inadequate infrastructure, long distances and lengthy times to reach needed services, transportation costs and adverse policies that affect travel. As transportation touches many aspects of a person’s life, adequate and reliable transportation services are fundamental to healthy communities and serve as a vehicle for wellness.

Primary Stakeholders: Community Residents, Motorists, Pedestrians, Cyclists, Transportation Authority, Public Transportation Operators, Car Share Drivers and Users, Law Enforcement, First Responders

Direct Transportation and Mobility Indicators of Social Health	Indirect Transportation and Mobility Indicators of Social Health
<i>Separation of Pedestrians and Vehicular Transit; Speed Limits; Pedestrian Access; Availability of Public Transit; Controlled Parking Zones; Land Use Typologies; Charging Infrastructure; Internet of Things (IoT) and Electronics; Sewage Management and Treatment; Quality of Infrastructure; Places to Stop/Rest; Fossil Fuels; Petroleum Products; Merchandise Storage and Travel</i>	<i>Accidents Between Vehicles and Pedestrians; Road Trauma; Psychosocial Disorders; Behavioral Health; Recreational Use of Road/Paved Surfaces; Heat Islands; Air Pollution; Noise Pollution; Water Pollution; Light Pollution; Visual Impact of Community Infrastructure; Investment Funds; Vector Borne Diseases; Response Time for First Responders; Cold-Chain Reliability</i>

Economic Wellbeing. Economic wellbeing factors are regularly measured as a mix of instruction, salary and occupation at the point when seen through a social class lens, which often accentuates financial benefit, power, and control. Economic factors are significant to all domains of behavior and sociology, including exploration, practice, training, and promotion (Dolan 2008). A closer examination of economic well-being social health indicators as a consistent variable emphasizes disparities in access to and the dissemination of assets throughout communities. The incorporation of economic social health indicators to the matrix of Social Scorecard will become an additional layer of data to produce location-specific graphics and analysis.

Primary Stakeholders: Community Residents, Small Business Owners, Corporations, Better Business Bureau, Planning Committees/Zoning Review Boards, Financial Analysts

Direct Economic Wellbeing Indicators of Social Health	Indirect Economic Wellbeing Indicators of Social Health
<i>Rates of Poverty; Rates of Unemployment; Vocational Training; Housing Tenure; Rent Subsidies; Insurance Rates; Career Service Resources; Availability of Investment Funds; Residential Income Revenue; Investment in Small Business</i>	<i>Raises in Rent; Real Estate Property Values; Rates of Incarceration; Rates of Homelessness; Access to Safe and Affordable Housing; Access to Safe and Affordable Food; Food Deserts</i>

Crime and Safety. Crime and violence describe the exposure to violence in many ways, including being victimized directly, as a witness to violence or property crimes in their community, or through hearing about crime and violence from other residents (Hartinger-Saunders 2012). Violence and a reputation for violence is a leading cause of the destruction of the health and well-being of a community; without the feeling of personal safety for residents within a community, the potential for growth through social cohesion, economic investment opportunities, and population demographics becomes stagnant. Moreover, the increasing number of individuals with diagnosed mental health and substance use conditions in the criminal justice system has enormous discal, health, and human costs (Mental Health America 2021). Incorporating crime and safety social health indicators into the matrix of Social Scorecard will allow for investment strategies to preemptively understand their impact on the social cohesion of urban environments rather than studying crime and safety statistics because of community investments.

Primary Stakeholders: Community Residents, Law Enforcement, Criminal Justice System, Firefighters, First Responders, Emergency Medical Technicians (EMTs), Community Watch

Direct Crime and Safety Indicators of Social Health	Indirect Crime and Safety Indicators of Social Health
<i>Controlled Parking Zones; Lighting Along Walking Paths; Speed Limits; Accidents Between Vehicles and Pedestrians Home Accident Prevention; Rates of Conviction; Fire Prevention; Internet of Things (IoT) and Electronics; Road Trauma; Registered Sexual Predators; Pedestrian Access; Drug Education Resources; Zones of High Crime</i>	<i>Zones of High Risk; Zones of Preventable Health Risk; Road Trauma; Response Time of First Responders; Rates of Incarceration; Communicable Diseases; Feeling of Safety; Light Pollution; Vector Borne Diseases Psychosocial Disorders</i>

Social Support and Social Context. People’s relationships and interactions with family, friends, co-workers, and community members can have a major impact on their health and well-being (*Social and Community Context* 2020). Many people face challenges and dangers they can’t control which can have a negative impact on health and safety throughout life; positive relationships at home, at work, and in the community can help reduce these negative impacts by providing an outlet for us to connect and process our traumas or grief. As such, interventions to help people get the social and community support they need are critical for improving the health and well-being of urban environments.

Primary Stakeholders: Community Residents, Municipal Officials, Social Workers, Criminal Justice System, Small Business Owners

Direct Social Support and Context Indicators of Social Health	Indirect Social Support and Context Indicators of Social Health
<i>Behavioral Health; Psychosocial Disorders; Social Status; Resident Age; Woman’s and LGBT Health Resources Track and Prevent Disease via Social Risk; Food Banks; Access to Community Resources; Community Maintenance; Reuse of Obsolete Infrastructure; Community-Dedicated Infrastructure/Space; Gender Identification; Community Engagement; Availability of Green Space; Public Transit</i>	<i>Recreational Use of Road/Paved Surfaces; Mental Health; Zones of High Crime; Non-Communicable Diseases; Ecosystems; Rates of Homelessness; Psychosocial Disorders; Zones of Preventable Health Risk; Communicable Diseases; Access to Safe and Affordable Housing and Food; Resident/Tenant Displacement; Civic Participation; Visual Impact of Community Infrastructure; Community Identification</i>

Food and Agriculture. According to the U.S. Department of Agriculture, food insecurity is defined as a household-level economic and social condition of limited or uncertain access to adequate food with either disrupted eating patterns or reduced food intake (Coleman-Jensen 2021). Food insecurity, a determinant of health, affect more than 12.7 percent of U.S. households – that is, an estimated 15.8 million households – in 2015 (Health Research & Educational Trust 2017). Adults who are food insecure are at an increased risk of developing chronic diseases, and children who are subject to food insecurity are at increased risk for developmental issues, which can lead to an increase in hospital readmissions and medical treatments.

Primary Stakeholders: Community Residents, Farmers, Agriculture Industry Workers, Food Providers, Convenience Stores, Distribution Workers, National Oceanic and Atmospheric Administration, National Science Foundation, Culinary Industry Workers

Direct Food and Agriculture Indicators of Social Health	Indirect Food and Agriculture Indicators of Social Health
<i>Soil Quality; Forestry Practices; Food Banks; Food Deserts; Merchandise Preservation and Safety; Merchandise Storage and Travel; Outdoor Temperature; Waste and Landfills; Livestock and Veterinary Drugs; Pesticides and Fertilizers; Mechanization of Work; Land Use; Cold-Chain Reliability; Fisheries Practices; Reliance on Imported Merchandise/Goods</i>	<i>Household Food Security; Access to Clean Water; Vector Borne Diseases; Air Pollution; Water Pollution; Soil Pollution; Quality of Food; Merchandise Availability; Biodiversity; Food Safety and Foodborne Illness Hazards; Climate Change; Access to Safe and Affordable Food</i>

Health Literacy. The U.S. Department of Health and Human Services (HHS) defines health literacy as “the degree to which individuals have the capacity to obtain, process, and understand basic health information needed to make appropriate health decisions” (Baker 2006). As low health literacy is associated with poorer health outcomes and use of healthcare services for community residents, understanding the cultural and linguistic barriers that often provide the context for the exposure to health literacy skills is crucial for healthcare providers to provide proper care to their patients. However, health literacy is not just the result of individual capacities to care for one’s health but also the health-literacy related demands and complexities of the healthcare system (Rudd 2007). Analyzing population demographics, especially in relation to linguistic, cultural and economic factors, provides a foundation for urban investment into healthcare opportunities to become more accessible for our diverse communities, and provide equitable, targeted care to their patients.

Primary Stakeholders: Community Residents, Healthcare Workers, Healthcare Researchers, Social Workers, Emergency Medical Technicians (EMTs), Centers for Disease Control and Prevention (CDC)

Direct Health Literacy Indicators of Social Health	Indirect Health Literacy Indicators of Social Health
<i>Rates of Literacy; Gender Identification; Ethnicity; Age; Communicable Diseases; Occupational Health Factors; Biological Sex; Access to Safe Living Conditions; Genetics; Intellectual Disabilities; Mental Health Conditions; Woman's and LGBT Health Resources; Response Time of First Responders; Access to Primary and Emergency Healthcare Services</i>	<i>Psychosocial Disorders; Zones of Preventable Health Risk; Behavioral Health Patterns; Mental Health; Insurance Rates; Track and Prevent Disease via Social Risk; Positive Patient Health Outcomes; Non-Communicable Diseases; Availability of Investment Funds</i>

Environmental Health. The neighborhood people live in have a major impact, both direct and indirect, on their health and well-being. Environmental factors – such as air and water quality, patterns of energy use, and patterns of land use and urban design – globally affect an estimated 24% of the disease burden, resulting in the loss of healthy years, and an estimated 23% of all premature deaths were attributable to environmental factors (Pruss-Ustun 2006). Many people in the United States live in neighborhoods with high rates of violence, unsafe air or water quality, effects of climate change, urban food deserts, and other health safety risks; while environmental factors are understood to be linked to detrimental health outcomes, the relationship between environmental health and other social determinant of health sectors – such as social contexts, transportation patterns, and economic wellbeing – has yet to be linked through the lens of social urban contexts.

Primary Stakeholders: Community Residents, Forestry Industry Workers, Energy Sector Workers, Sustainable Designers, National Oceanic and Atmospheric Administration, National Science Foundation, Department of Energy, Agriculture Industry Workers

Direct Environmental Health Indicators of Social Health	Indirect Environmental Health Indicators of Social Health
<i>Availability of Green Space; Land Use; Hydropower; Biodiversity; Pesticides and Fertilizer; Soil Quality; Forestry Practices; Sewage Management and Treatment; Stormwater Runoff Management; Water Quality; Humidity; Solar Energy; Ecosystems; Allergens and Dust Mites</i>	<i>Communicable Diseases; Heat Islands; Climate Change; Places to Stop/Rest; Vector Borne Diseases; Outdoor Air Quality; Air Pollution; Water Pollution; Soil Pollution; Light Pollution; Non-Communicable Diseases; Visual Impact of Community Infrastructure</i>

Population Demographics. Many health experts believe that your ZIP code could be as crucial to your potential health outcomes as your genetic code; according to the Institute for Medicaid Innovation, socioeconomic and physical environmental factors that are directly linked to your local area account for up to 50 percent of overall health outcomes, with another 30 percent tied to health behaviors which can affect Social Determinants of Health as well (Rumsey 2020). As Social Determinants of Health challenges vary based on local conditions and can impact an individual's overall health and quality of life, the act of analyzing a community's demographic make-up must become fundamental when determining social intervention strategies.

Primary Stakeholders: Community Residents, Census Bureau, Municipal Officials, Population Health Researchers and Analysts, Community Watch, Law Enforcement, School Boards/Administrators

Direct Population Demographics Indicators of Social Health	Indirect Population Demographics Indicators of Social Health
<i>Residential Income Revenue; Rates of Literacy; Age; Gender Identification; Marital Status; Ethnicity; Registered Felons; Registered Sexual Predators; Biological Sex; Social Status; Languages; Genetics; Intellectual Disabilities; Mental Health</i>	<i>Non-Communicable Diseases; Rates of Homelessness; Rates of Poverty; Rates of Unemployment; Rates of Conviction; Rates of Incarceration; Rates of Drug Use; Insurance Rates; Community Identification</i>

Energy Consumption. Within the technological age, energy has become an important resource for the economic development of a nation and the social well-being of its citizens. While the discussion surrounding the sourcing and use of energy has both positive and negative implications for international and domestic relations, the traditional methods of fossil-fuel dependent energy sources through extraction, transportation and use has overwhelmingly negative consequences to the health, environment, and economics of a society. Access to abundant, affordable, secure, safe, and clean energy is beneficial for global society, as reliance for imported energy can create vulnerabilities to a nation's security (Climate Literacy & Energy Awareness Network 2020). Furthermore, insufficient energy supply is detrimental to the economic growth of economies of both developed and developing countries, leading some energy experts to indicate that in the fact of increases in energy consumptions, there is the need to conserve existing energy use by using energy efficient means (Yeboah 2013). As nations continue to develop in the pursuit of a stable and thriving economy, combined with predicted population growth trends, energy consumption will inevitably increase and, as such, an understanding of the variables significant in influencing energy consumption patterns must be integrated into urban planning strategies.

Primary Stakeholders: Community Residents, Energy Sector Workers, Department of Energy, Municipal Officials, National Oceanic and Atmospheric Administration, Agriculture Industry Workers

Direct Energy Consumption Indicators of Social Health	Indirect Energy Consumption Indicators of Social Health
<i>Internet of Things (IoT) and Electronics; Petroleum Products; Availability of Investment Funds; Fossil Fuels; Nuclear Power; Solar Energy; Land Use; Mechanization of Work; Hydropower; Charging Infrastructure; Biomass Fuel; Waste and Landfills; Occupational Health Hazards</i>	<i>Water Pollution; Soil Pollution; Noise Pollution; Air Pollution; Light Pollution; Visual Impact of Infrastructure; Ecosystems; Biodiversity; Climate Change</i>

Retail and Restaurants. A convergence of powerful external and internal forces – coverage expansion through healthcare reform, technological advances, rising consumerism, retailers’ desire for increased foot traffic and cross-selling opportunities, and more – are prompting may retailers to consider broadening their corporate growth strategy to include health wellness services (Delegram 2015). Considering the COVID-19 pandemic and as the social and environmental context surrounding retail and restaurants continues to evolve because of shutdowns and financial restraints, capitalist societies have been forced to confront unprecedented challenges. One part of the evolution means altering business operations to ensure the health and safety of retail customers and employees, but the implications for social wellbeing of communities extends beyond the direct interactions experienced within retail settings. Lockdown and social distancing measures to prevent the spread of COVID-19 have resulted in increasing levels of domestic violence (Nicola 2020).

Primary Stakeholders: Community Customers/Consumers, Small Business Owners, Culinary Industry Workers, Municipal Officials, Corporations, Better Business Bureau, Food Providers, Convenience Stores, Distribution Workers

Direct Retail and Restaurant Indicators of Social Health	Indirect Retail and Restaurant Indicators of Social Health
<i>Land Use; Cold-Chain Reliability; Merchandise and Brand Availability; Quality of Infrastructure; Internet of Things (IoT) and Electronics; Community Displacement; Building Materials; Access to Clean Water; Indoor Air Quality; Pesticides and Fertilizer; Allergens and Dust Mites; Merchandise Preservation and Storage; Merchandise Storage and Travel; Waste and Landfills; Real Estate Property Values; Zoning and Building Typologies; Infrastructure Crime Prevention</i>	<i>Food Safety and Foodborne Illness Hazards, Community Engagement; Access to Safe and Affordable Food; Rates of Poverty; Rates of Unemployment; Recreational Use of Road/Paved Surfaces; Raises in Rent; Water Pollution; Soil Pollution; Air Pollution; Visual Impact of Infrastructure; Quality of Food; Reliance of Imported Merchandise; Food Deserts; Fire Prevention; Occupational Health Hazards</i>

NEXT STEPS

With an aim to serve as a foundation of research in the formation of a parametric matrix tool to assess the social health of urban environments, Social Scorecard articulates indicators of social health and their interconnected relationships. Programs that could provide valuable skills and knowledge in the creation of Social Scorecard as a functioning evaluation matrix tool include:

Geospatial Technology for Geodesign. The primary goal for collaboration with the Geospatial Technology for Geodesign program would be the creation of GIS-based maps depicted existing conditions relevant to social health; these base maps will serve as the base to be analyzed to create a parametric modeling too to graphically depict an urban environment’s social health via overlaid heat maps of each Social Determinant of Health sector. Secondary goal for collaboration would be the exploration of the parametric modeling tool and its impact to social health determinants to accordance with the outlined Social Scorecard conceptual model.

Relevant Skills and Experience: GIS-based tools, 3D parametric modeling, sustainable design approaches, collaboration and innovation with an integrated process

Public Health. The intended goal for collaboration with the Public Health program would be to identify and integrate health data and desired patient outcomes into the matrix of Social Scorecard. Equipped with the knowledge required to interpret health data and its impact on public health, collaboration with the Public Health program would be able to provide an avenue to develop policy and design techniques to reduce exposure to harmful environmental conditions within urban contexts.

Relevant Skills and Experience: competencies in several key public health areas: health behavior and social sciences, biostatistics, environmental health, epidemiology, policy and advocacy, program planning, implementation and evaluation of public health intervention strategies

Health Data Sciences. The intended goal of collaboration with the Health Data Science program, combined with Public Health, would be to ensure proper integration and evaluation of health data sets into the matrix of Social Scorecard. Incorporating their graphic representation skills with those within the College of Architecture and the Built Environment programs will encourage an interdisciplinary graphic set in communicating varying layers of information.

Relevant Skills and Experience: statistical inference. algorithmic development, and technology to make insights about technical health data

Leveraging the collaboration opportunities listed above and this body of research, the final aim is to create a parametric modeling script capable of integrating these indicators of social health and predicting possible outcomes. This would allow us to create heat maps indicative of existing social health conditions within a chosen location; once a capitalist investment strategy has been chosen to improve the desired determinant of social health, matrixed would be adjusted and this tool would provide a layered heat map illustrating the potential impact.

As opposed to addressing determinants of social health within these traditionally isolated sectors, the comprehensive nature of the proposed Social Scorecard parametric tool may encourage companies and/or government officials to develop solutions with broader return on investment opportunities. As an example, investments in strategies focused on the reduction of food deserts and promoting healthy food behaviors has broader potential impacts than the original aim, such as: reduction of costs within healthcare, raise of real estate property values, and even encouragement of social engagement within the community which could be evaluated through this tool.

REFERENCES

- Air Quality and Health WHO Team. 2017. *Determinants of Health*. World Health Organization.
- American Society of Landscape Architects. 2021. *Sustainable Urban Development*. Washington, D.C.: American Society of Landscape Architects.
- Beverina, Anthony. 2019. *The Significant Seven: Our Components of the Social Determinants of Health*. Washington, D.C.: Socially Determined Foundation.
- Climate Literacy & Energy Awareness Network (CLEAN). 2020. *The Qualities of Life of Individuals and Societies is Affect by Energy Choices*. National Oceanic and Atmospheric Administration, National Science Foundation, Department of Energy, and NASA.
- Coleman-Jensen, Alisha, et al. 2021. *Definitions of Food Security*. U.S. Department of Agriculture, Economic Research Service.
- Delegram, Thomas, Matthew Hourin, and David Betts. 2015. *Retail Health & Wellness*. Deloitte LLP.
- Dolan, Peter, et al. 2008. *Do We Really Know What Makes Us Happy? A Review of the Economic Literature on the Factors Associated with Subjective Well-Being*. *Journal of Economic Psychology* 29, No. 1: 94-122.
- Hartinger-Saunders, Ronald, et al. 2012. *Neighborhood Crime and Perception of Safety as Predictors of Victimization and Offending Among Youth: A Call for Macro-Level Prevention and Intervention Models*. *Child Youth Serv Rev* 34, 9: 1966-1973.
- Health Research & Educational Trust. 2017. *Social Determinants of Health Series: Food Insecurity and the Role of Hospitals*. Chicago, IL: American Hospital Association.
- Healthy Streets*. 2021. London, England: Greater London Authority, London Assembly.
- Mental Health America. 2021. *Mental Health and Criminal Justice Issues*. Alexandria, VA: Mental Health America, Inc.
- Nicola, Maria, et al. 2020. *The Socio-Economic Implications of the Coronavirus Pandemic (COVID-19): A Review*. London, England: *International Journal of Surgery* 78: 185-193.
- Nowak, David, and Jeffery Walton. 2005. *Projected Urban Growth (2000-2050) and Its Estimated Impact on the US Forest Resource*. *Journal of Forestry*: 383-389.
- Pruss-Ustun, Annette, and Carlos Corvalan. 2006. *Preventing Disease Through Healthy Environments: Towards an Estimate of the Environmental Burden of Disease*. World Health Organization.
- Rolfe, Steve, et al. 2020. *Housing as a Social Determinant of Health and Well-Being*. *BMC Public Health* 20, 1138.
- Rumsey, Matthew, et al. 2020. *The Social Determinants of Health: Improving Population Health Data-Driven Insights*. Washington, D.C.: ZeOmega, Center for Open Data Enterprise (CODE).
- Social and Community Context*. 2020. Washington, D.C.: Office of Disease Prevention and Health Promotion, Office of the Assistant Secretary for Health, Office of the Secretary, and U.S. Department of Health and Human Services.
- Sotres, Pablo., et al. 2017. *Practical Lessons From the Deployment and Management of a Smart City Internet-of-Things Infrastructure: The SmartSantander Testbed Case*. *Access IEEE* 5: 14309-14322.
- Stach, Edgar. 2021. *Transforming Urban Environments*. Philadelphia, PA: Thomas Jefferson University, Institute for Smart and Healthy Cities.
- WHO Regional Office for Europe. 2021. *What is a Healthy City*. World Health Organization.
- Yeboah, Samuel, Ohene Manu, and T.B. Wereko. 2013. *Determinants of Energy Consumption: A Review*. *International Journal of Management Sciences* 1, No. 12: 482-487.

Resilience at the Water's Edge

Vera Parlac¹

¹New Jersey Institute of Technology, Newark, NJ

ABSTRACT: This paper discusses projects that address resiliency at the water's edge. It raises questions about the nature of the negotiated territories that occupy this boundary. In nature, the capacity of organisms to adapt to changes in their environment defines their resilience. In the built environment, resilience is traditionally seen as the capacity to resist a potentially catastrophic event; this is often achieved with specific materials or engineered construction techniques. But what might make architecture truly resilient is its ability to productively engage with its larger natural or cultural ecology – to be able to 'respond' to challenges it is facing. To achieve this, architecture, and the built environment in general, should be more tightly connected to the dynamics of those ecologies in order to facilitate an active response to disruptions. How can we design for resilience without resorting to the highly engineered control of unpredictable events? As the natural and constructed worlds meet, there is a need to control the interface between them by preventing what we anticipate to be undesirable effects. That very space is what generates some of the most interesting questions pertaining to the humanity's relationship to technology. The impermeability of a boundary that separates the constructed environments from the natural, and our perception of what is deemed undesirable, might need a second look. This paper will discuss projects and issues raised by some of the recent projects by BIG (Bjarke Ingels Group), a proposal for Tencent Net City by Jonathan Ward (Design Partner at NBBJ), and proposal to prevent further erosion of Venice foundations by Rachel Armstrong (Professor of Experimental Architecture at the Department of Architecture, Planning and Landscape, Newcastle University).

KEYWORDS: resiliency, water edge, flood, rising sea levels

RISING WATERS: INTRODUCTION

Millions of people around the world live in zones affected by the rising sea levels. Consequences are felt after each heavy rain and storm event – or in some low laying regions of the world, even permanently. Existing infrastructure designed to protect communities from water level oscillations is increasingly being challenged by compounded effect of climatic fluctuations.

As urban settlements grew, their edges along the water transformed from green areas, estuaries, or wetlands into industrial zones or transportation corridors. This loss of natural habitat, increase in impermeable surface area, and inadequate infrastructure planning has made cities particularly vulnerable to seasonal or sudden water level surges, tidal inundation, or groundwater table rise. Strategies to address these conditions are increasingly inspired and enriched by reappropriation of techniques that acknowledge the need to co-exist with fluctuating waters as opposed to control them. These techniques focus on negotiating natural variations of water levels and human occupancy. This approach is more complex and involves many stakeholders, from governments, to engineers, designers, scientists, and public. But it also reflects a cultural change in our relationship with the water and its flux. As public policies create space for negotiating the shifting edge of the water, they are also moving away from hard engineering techniques that were so prevalent in the past (Rossano 2021). In urban environments that rely on underground drainage and the containment of water dynamics, a discourse about inundation brings up a new perspective that positions this edge as a living and adaptive environment able to accommodate these changing rhythms and provide spaces for natural processes to unfold. Negotiating this is challenging. It requires the reintegration of uncertainty into a designed environments that include human activities, flood or storm events, as well as the incremental processes of sea level rise. It also requires an awareness that contested edges are never fixed; they fluctuate over time, releasing and claiming territory. How can design accommodate this continuous change?

1.0 SHIFTING GROUND: EXAMPLES

The shift from a vertical containment approach (levees, dams, pumps) to horizontal strategies (widening, temporary storage) is associated with the renewed focus on ecology and an intensification of the natural edge. Softening of the water's edge as a flood mitigation strategy brings together ecology and urbanity. This is reflected in many current designs in urban centers. However, the space for the ebb and flow of the contested edge is a difficult design challenge; it eludes the line of separation. If we accept the idea of a shifting ground, the question of permanency, as well as ownership, is brought into question.

We measure, survey, determine flood plains and then build structures in relation to determined metrics that disregard the fluctuating nature of a dynamic force that makes many bodies of water uncontrollable. Mathur and da Cunha pointedly ask: What are the measures that can “still its dynamics to make it a subject of design? [...] are there other measures more accommodating of its shifts?” (Mathur and da Cunha 2001, 38) Their question refers to the Mississippi River and the heavily-engineered design of its containment, but could easily refer to any dynamic body of water. The main question is where we start and stop measuring to design a control system, because designing a transitional territory would have to allow for give and take and account for constant shifting.

In the fall of 2009, the Museum of Modern Art initiated the Rising Currents: Projects for New York’s Waterfront, selecting five interdisciplinary teams to rethink urban infrastructure in the face of rising sea levels. This project was instrumental in starting a conversation among many interested groups, from private citizens to scientists, city officials, state, and federal government about how to address the complex issue of living with climate change. These projects formulated innovative solutions that address dynamics of the water-land boundary, accommodating human activities and evolving natural habitats. The solutions ranged from introduction of absorptive wetlands and parklands, and porous green streets (Architecture Research Office (ARO), DLANDstudio); new natural and economic ecologies with recycling facilities and energy producing elements (Matthew Baird Architects); protection and exploitation of low landfills that are subject to the continual dynamics of water (Lewis Tsurumaki Lewis Architects); engaging the issue of contamination, water quality, encroaching tides and natural oyster habitat (Scape); to novel urban paradigm that encourages silt accumulation fostering natural resiliency (nArchitects) (Bergdoll 2011). These projects created soft infrastructure and explored the edge between the water and land as a wide threshold that could accommodate water fluctuations in a different way, beyond the usual engineered solutions.

Several years later the aftermath of the Hurricane Sandy led New York City to seriously think about its resiliency and flood protection. The Lower Manhattan Climate Resiliency Study was developed in March 2019: This study considers a wide range of climate hazards such as storm surge, excessive precipitation, or heat wave, but also conditions like sea level rise, groundwater table rise, and tidal inundation that plagues coastal communities across scales.

Tidal inundation, groundwater table rise, and extreme precipitation, all present a constant risk for low-lying coastal regions and cities built in these areas. These risks will only increase with the rise in frequency of these events. According to the Lower Manhattan Climate Resilience Study, by the year 2100 all these factors will impact the city’s sewer system, underground transportation system, underground utilities, and in some areas street transportation (Lower Manhattan Climate Resilience Study 2019). This would impact not only the ability of businesses to operate but also potentially structurally destabilize older buildings, generally disrupting daily life of the affected district.

The study provides a list of various adaptation strategies for flood protection, and they mainly revolve around three approaches: (1) let the water in, (2) elevate properties or land edges, or (3) extend the water’s edge further by land reclamation. Each one of these approaches has their challenges. If flood waters are allowed to flow in, various levels of waterproofing and deployable flood gates, utility relocation, and structural stabilization are necessary. Elevating properties, streets, and land edges requires a change in city planning strategies that, when applied piecemeal to existing cities, require substantial engineering. Extending the water’s edge requires an engineered solution that further encroaches on marine habitats. The study underlines that a strategic combination of these approaches, planned for longer stretches of the coast, is required to address the challenges of rising waters.

Bjarke Ingels Group and One Architecture were among the main consultants for the Lower Manhattan Climate Resiliency Study and their collaboration resulted in the Big “U” proposal developed to protect Lower Manhattan from the impact of flooding and rising waters. The proposal was conceived as a 10-mile-long protection zone stretching from East River Park to the Battery, broken into four physically separated flood protection areas: East River Park, Two Bridges and Chinatown, Brooklyn Bridge, and the Battery. Even though these areas work together to protect the city, they are designed to stand on their own during the flood and to address individual typology of each neighborhood. A combination of bridging berms, deployable walls, and upland landscapes form the flood protection while at the same time providing a public space for leisure and recreation. In this project the resiliency infrastructure, besides its protective role, must address the needs of people, be integrated into spaces for various human activities, and address unique community needs (The Big “U”, 2014). This approach is informed by BIG’s experience in Denmark and the Netherlands and is focused on providing social and environmental benefits for all neighborhoods by making the infrastructure multifunctional. However, a closer look at the proposal might raise the question that this new public space/realm is yet another layer over an already engineered edge that for 150 years has served to extend boundaries of capital and profit currently threatened by the rising sea levels: What has fundamentally changed? One cannot help but wonder whether this proposal considers change of the edge over time. The Big “U” project deals with an already established edge that doesn’t have much space to accommodate a transitional zone where natural accumulation of silt or sand would begin to erase or displace human activity.

In 2000 the City of Hamburg decided to transform part of the former Harbour into a new residential, office and retail area, almost building a district from scratch (HafenCity). The area lies in front of the main dike-line of Hamburg adjacent to the Elbe River. The flood management strategy was developed to avoid enormous investment of building another dike around it – a move that would have most likely delayed building development. Instead, elevated plots were built to facilitate incremental development of the site. Individual built-in flood resistance was introduced, shifting the part of responsibility for flood-preparedness to property owners (Mees et al., 2013). But what is particularly interesting about the HafenCity is that it gives the water space to flow instead of trying to stop it with dikes. Some public spaces are designed to be flooded while some streets are raised to allow emergency vehicle movement; homes are not allowed on ground levels, but offices and businesses are; buildings are equipped with flood doors. The strategy is shaped by an understanding that, to be resilient, urban environments must co-exist with raising waters. Successful strategies will limit exposure but also create spaces that water can temporarily occupy (Febris 2015). These expanded thresholds allow water to occupy space and are designed to require minimal maintenance after the water recedes. However, the space occupied by the river during the flood events is always returned to the city. It is cleaned and brought back into its pre-flood state, negating a possibility that natural processes of flooding could claim new territory from the city. The possibility of shifting the boundary between the city and river is always erased.

As the rapid urbanisation takes place so does a rapid takeover of the land and marine ecosystems that serve as a natural barrier to the floods and excess precipitation. Tensent Net City in Shenzhen is a new city being built on the reclaimed land jutting out into the Pearl River estuary. NBBJ, with Jonathan Ward as a lead oversees its masterplan. The city is conceived as an integrated and decentralised network connecting multiple focal points and shoreline into a new distributed grid. It is conceived to promote resilience and natural ecosystem making a waterfront its driver and promoting not only people's needs but also the requirements for a thriving environment. The ability of this new coastal city to deal with the climate change and raising sea level follows a Sponge City model (Ward, 2021) that requires the city edge to soak in the water. This is achieved by using a natural barrier to deal with a water rise and storage of the excess rainwater. At the same time, this edge is a place for human activity, especially public activities of leisure and recreation. Ward suggests that the future of the city will be to fuse more closely with. This is precisely an approach that perpetuates the idea that nature can and should be held captive and confined to serve the human needs. Or is this perhaps an attempt to explore a shifting boundary between designed and evolving?

The Sponge City initiative was started in China in 2014 as a strategy to decrease flood risk, increase water supply and improve water quality. Even though it is similar to the sustainable drainage systems in the UK or low impact development in the USA, it is different in that it is applied in a context of rapid urbanization and therefore a rapid takeover of the land and marine ecosystems that serve as a natural barrier to the floods and excess precipitation. The concept of Sponge City envisions drainage infrastructure designed to perform as a sponge to absorb as much water as possible during rainstorms. This is done either through natural soils and geology or by building storage areas. Semi-natural or purpose-built bioreactors can then filter the water before it reaches natural bodies of water. This urban drainage system has a two-part role: to respond to the increasing threat of urban flooding and to upgrade failing urban drainage system to also capture, purify and store rainwater. The Sponge City guidelines advocate for the use of natural drainage whenever possible (soil infiltration) to improve surface water quality and to conserve water. The Chinese government also called for adoption of these guidelines by all new city developments making its scale and ambition greater than other international initiative such as LID in the USA or SUDS in the UK (Griffiths et al. 2020). This is reflected in its short-term goals of integrating Sponge City as small-scale urban pilot projects, then increasing it to have more than 20% of municipal areas able to recycle 70% of rainfall by 2020, to completing integration of the concept with more than 80% of municipal areas able to recycle 70% of rainfall by 2030 (Griffiths et al. 2020). It remains to be seen to what extent this new city will allow its boundaries to be affected by change in its natural component and to what extent its designed edges will be affected by it.

2.0 QUESTIONS

Dealing with the water-land edge is a difficult design and infrastructure problem. As a counterpart to MOMA initiated Rising Current project, we see government initiatives such as the Lower Manhattan Climate Resiliency Study and the Sponge City model shaping the city/water edges. But the question of how to design this edge remains. Do we think of it as a natural edge and complex ecosystem or as an urban edge porous enough to accommodate shifting boundaries between the constructed and natural? Or is this another designed edge with the focus on Nature finding its way into resilience design proposals? Is amplifying the natural – de-naturing or de-naturalizing as Kai-Uwe Bergman of BIG calls it – yet another way of consuming nature with the goal of claiming even more space for human activities?

Most of these solutions are trying to define the water/land edges of the city as a buffer between the fluctuation and unpredictability of rising water levels. We have all been to these spaces, we like them, they present us with pleasant and safe frames of 'nature', they help us walk to the water's edge without getting our feet wet or getting mud on our shoes. Is this a sterilized connection to the water, a manicured edge? Do these approaches allow natural forces to take their course in these zones and to what extent? What happened in the HafenCity after the flood? Could those plazas designed to get flooded be 'redesigned' by natural forces? Could the edge of a designed space be pushed a bit further, and the flooded zones give rise to their own new ecologies and connections? What happens when nature gets into

designed zones, when forces of nature work over the forces of designed confinements? How do we allow for the ebb and flow of these forces and for transitions or to take over the natural systems? Or are we still entirely devoted to preserving the spaces we claim as ours through design and building? The shifting of these territories is not taken into consideration primarily because we build for permanence. The question is then how we should build for flux and contested conditions?

I wonder what will happen over time to all those designed edges, boardwalks, artificial beaches, and other designed features. Will they be taken over by the natural habitats sometimes incorporated into them? Would this new life be allowed to take over these landscapes that are still seen as a private or public property that must be maintained for use by people? How do we design to accommodate change over time? Designing for the whole of life, as Bruce Mau suggests, would perhaps offer a framework to accommodate shifting boundaries of these contested territories. Placing life (not human experiences) at the center of design would require a shift in thinking – a change in expectations that everything needs to be available for human use. This attitude would bring a significant difference in how boundaries and contested edges are designed.

3.0 PERMEABLE BOUNDARIES: DESIGNING THE AGENT THAT BUILDS THE GROUND

In the early 1960s, William Katavolos, an avant-garde architect and designer, suggested that we shouldn't stop at decoding natural to develop artificial but that the artificial should be decoded as well. He argued that building architecture using natural materials and adjusting the way we build to a found resource and its properties is obsolete. In his view co-creating with nature would offer materials that afford new possibilities. Since 1960, he has been arguing for the power of chemistry to manipulate and design new materials (Katavolos 1994). Katavolos speculated about growing buildings through pre-programmed combinations of atoms. This chemical model could be seen as a precursor to nanotechnology, and was very much ahead of its time. Today we see the power of biotechnology in co-creating life forms and the power of synthetic biology in co-creating ecologically responsive materials. Such work makes the boundary between organic and artificial more porous; it blurs the line between design and modern biology, raising many challenging social and environmental questions. It posits a very different framework within which designers create new tools and techniques that in turn inform scientific discourse.

In an article published in 2010, Rachel Armstrong, Professor of Experimental Architecture at the Newcastle University, discusses a new class of materials, developed with technologies derived from synthetic biology, which are capable of “decision making” by relying on the chemical computational power of their molecules (Armstrong 2010). They are “programed/designed” to make decisions about their environment and respond to it in complex ways that involve a change in their form, function, or appearance. Responsiveness of these materials lies in their capacity for chemical computation. Without the need to rely on traditional computing methods and actuation devices these materials offer a very different way of imagining an operational capacity of matter. In 2014, Armstrong went on to explain how a synthetic limestone-like structure could be built – or rather grown – underneath Venice to prevent the continuous erosion of the city's foundations. This artificial reef would be grown using protocell technology. Protocells have a very simple metabolism, and they can perform in lifelike ways. Armstrong proposes that these protocells could be designed to be photophobic, which would drive them towards dark foundations; they would also react with minerals to build or grow the limestone-like material that would reinforce existing wooden piles.

This very different and perhaps unsettling approach to addressing the sinking of Venice proposes a different use of technology. In the protocells, initially inert materials are imbued with some properties of living organisms. They can grow and produce matter. The engineering here is not concerned with its might but it happens on a different scale and works discreetly. Here scientific imagination meets architectonic one. Could they share the territory where form and space have to be at the same time inhabited and appropriated? Could one perpetuate the notion of emergence (imbued by the materially driven process and thinking) and allow it to inform and influence programmatic and urban participation of the architectural intervention?

4.0 NEGOTIATED TERRITORIES: CONCLUSION

For more than a millennium, indigenous people built “sea gardens” along the Canada's Pacific coast (Selkirk 2021). These subtle structures relied on the daily and seasonal tidal rhythms to intercept migrating fish, effectively creating a sustainable fishery. The traps are based on a deep knowledge of fish behaviour and the region's large tidal ranges, revealing impressive engineering skills of indigenous people: While some nations used sticks and lattice fences to manage fish runs, others built low walls parallel to the shore. These walls would capture silt over time and change the slope of the beach to create large flat intertidal areas that were carefully tended to create habitat for marine life. At times of low tide, these zones would trap the fish for selective harvesting (White 2003).

In India's regions of water scarcity, bunds operated by sluices subtly formed changes in the ground level, capturing water for centuries. The Thousand Tanks of Bangalore were skilfully constructed before the English arrived and implemented their own system of public works. Even though seen by English as a system of flood control and water use, the system of lakes operated as a vast field of interconnected basins where water moved as an overflow: The bunds and sluices were built to manage and acknowledge complexities of interactions needed to negotiate the flux and

not to control the floods (Mathur and da Cunha 2006). The insight guiding the design comes from a deep understanding of the subtleties brought on by complex forces working in unison over the landscape: water, geography, human settlement, and occupation.

There is a history of acknowledging transitional landscapes in many non-western cultures: indigenous people of the pacific coast who, in the past, built and tended “sea gardens” for sustenance and stewardship of marine life; and infrastructure of tanks in Bangalore, built in 1791 to harvest seasonal water flows. These and many more examples express the design wisdom of non-designers who worked from the generational experience and respect for the land. They understood the subtlety necessary to negotiate the contested territories where human occupation meets the water edge. This is what makes current proposals that simulate the natural water edge and natural habitats in the highly urban zones problematic. They seem to be what Rahul Mehrotra, an Indian architect and educator, calls, “architectures of impatient capital settling too quickly.” Perhaps the most interesting aspect if these re-creations of natural edges is the possibility of change that could take place over time. Depictions of the proposed projects and their design most often don’t show or perhaps even don’t take into consideration transformation over time as water edges begin to live, as constructed edges and walkways or breakwaters start to accumulate silt and change their topography. Presently, as this slow change takes place, they will be cleaned after the flood and the change erased to return them to the originally designed condition. We need to start to design edges by taking time and change into consideration, and with it, the messy process of designing for all life and not just human occupation.

In their book *Mississippi Floods*, Anu Mathur and Dilip da Cunha trace the difficult, if not impossible efforts of U.S. Army Corps of Engineers to confine the Mississippi River to its “firm ground” by “elaborate and calculated control system” (2001, xii). The call for controlling a river or withdrawing settlements, sparked after every catastrophic event, underlines the dichotomy with which it is approached; the clear distinction in the landscape between “river and settlement, nature and culture, water and land” has always been reinforced even though in the aftermath of every flood we can see, in the landscape of the flood, these distinctions erased (Mathur and da Cunha 2001). This attempt to tame the Mississippi River perceives it as an object, as a thing that can be designed and therefore controlled, and not as a driving force of nature. This attitude subjugates the river’s ecologically multidimensional environment to the socially and economically contracted milieu of private property protection. This is reflected in the current attitudes of dealing with the edge between the water and land. Even though the language has changed from the one that clearly delineates the two to the one that acknowledges this edge as a zone, design practices still seem to presuppose that the job is done by designing this edge as a zone that later can be cleaned and return into its previous state. The same attitude considers constantly rising sea levels or flooding rivers as something that can be pushed back. Negotiating or acknowledging these new territories as “shifting landscapes” requires a change in design thinking. Mathur and da Cunha suggest that viewing the river as “a dynamic, living phenomenon that asserts its own dimensions” reveals its complex role in giving life to intertwined natural and social ecologies that thrive when able to negotiate across territories as opposed to delineating them by distinct boundaries.

How can we intersect generational wisdom that demonstrates a capacity to share the planet with other species and technological prowess that deploys heavily engineered solutions or more subtle yet still unsettling tools of synthetic biology? Who are the stakeholders in these negotiated territories? People that use the space, capital that constructs the space, municipalities that maintain it, non-human life that inhabits it – some of them prefer the language of the separation that clearly delineates boundaries of control and ownership while others operate in different dimensions that favor flows and blurred boundaries. How do we bring these two distinct positions together?

REFERENCES

- Armstrong, Rachel. 2010. “Systems Architecture: A New Model for Sustainability and the Built Environment using Nanotechnology, Biotechnology, Information Technology, and Cognitive Science with Living Technology.”, *Artificial Life* 16, no. 1, (Winter): 73–87.
<https://doi.org/10.1162/artl.2009.16.1.16101>
- Bergdoll, Barry. 2011. *Rising Currents: Projects for New York’s Waterfront*. New York: The Museum of Modern Art.
- BIG - Bjarke Ingels Group. 2014. “The Big “U”: Rebuild by Design.” <http://www.rebuildbydesign.org/data/files/675.pdf>.
- Fabris, Peter. 2015. “New Neighborhoods in Hamburg, Germany resilient to flooding, carbon neutral.” *Building Design + Construction*, November 30, 2015. <https://www.bdcnetwork.com/new-neighborhoods-hamburg-germany-resilient-flooding-carbon-neutral>.
- Griffiths, James, Faith Ka Shun Chan, Michelle Shao, Fangfang Zhu and David Laurence Higgitt. 2020. “Interpretation and Application of Sponge City Guidelines in China.” *Philosophical Transactions of the Royal Society A* 378, no. 2168 (February): <https://doi.org/10.1098/rsta.2019.0222>.
- Katavolos, William. 1994. “The new Palladio, Poesis versus Noesis.” (part 1 of 12), [core.form-ula](https://vimeo.com/coreformula), <https://vimeo.com/coreformula>.
- New York City Economic Development Corporation. 2019. *Lower Manhattan Climate Resilience Study*. https://edc.nyc/sites/default/files/filemanager/Projects/LMCR/Final_Image/Lower_Manhattan_Climate_Resilience_March_2019.pdf.

- Mathur, Anuradha, and Dilip da Cunha. 2001. *Mississippi Floods: designing a shifting landscape*. New Haven and London: Yale University Press.
- Mathur, Anuradha, and Dilip da Cunha. 2006. *Deccan Traverses: The Making of Bangalore's Terrain*. New Delhi: Rupa & Co.
- Mees, Heleen, Peter Driessen and Hens Runhaar. 2013. "Legitimate Adaptive Flood Risk Governance Beyond the Dikes: the cases of Hamburg, Helsinki and Rotterdam, Individual case study reports." Copernicus Institute of Sustainable Development, Utrecht University, Netherlands, March 2013, <https://edepot.wur.nl/341526>.
- Rossano, Frederic L.M. 2021. *Flood Scapes: contemporary landscape strategies in times of climate change*. Rotterdam: nai010 publishers.
- Selkirk, Diane. 2021. "An underwater mystery on Canada's coast." BBC, October 14, 2021. <https://www.bbc.com/travel/article/20211013-an-underwater-mystery-on-canadas-coast>.
- Ward, Jonathan. 2021. "Future Cities with NBBJ." Interview by Sam Lubell, Design Disruption Episode 9, May 17, 2021, video, <https://www.archdaily.com/958657/design-disruption-episode-9-future-cities-with-nbbjs-jonathan-ward>
- White, Xanius Elroy Alden Felix. 2003. "Helitsuk Stone Fish Traps: Products of my Ancestors' Labor." Master of Arts theses, Simon Fraser University. file:///Users/parlac/Downloads/etd2518.pdf.

Climate Resilient Urban Nexus Choices for Carbon Positive and SynBio City Scenarios from 2018 to 2100

Thomas Spiegelhalter¹

¹Florida International University, Miami, FL

ABSTRACT: Climate change threatens South Florida communities primarily in heat waves, hurricanes, saltwater intrusion, subsiding soils, rising groundwater tables due to rising sea levels (SLR). During recent years, SLR has accelerated the corrosion of steel and weakened infrastructures and buildings, prone to collapse. Forensic investigators, engineers, and scientists do their due diligence to analyze the causes of this destruction. They use diagnostics tools and thousands of AI-assisted science data of sensor real-time support systems to mitigate further destruction and create adaptive scenarios and relocation efforts. Government agencies at federal, state, and local levels have taken actions to monitor, project, and plan for this change and urgent adaptation in the following decades. As a result, the development of resilient communities against sea-level rise has become a priority at all levels of planning. A three-year 1,9 Mio. funded EU 2020 Horizon, US National Science Foundation research with interactive Carbon-Neutral-City Baseline Scenarios research tools from now to 2100 for Miami's Greater Islands has been developed. It helps better address and disseminates science for fitness-tested scenarios for citizens and decision-makers. It is currently in a public beta testing mode. The web tool allows users to select a geographic area within Miami and the Greater Island's boundaries and slide through different scenarios and designs of SLR between 30 cm and 244 cm and hurricane category 1 to 5 storm surges. The application visualizes the extent of floodings in response to these data-driven scenarios and returns associated statistics about their potential impact on residents, service infrastructures, demography, properties, land use. The tool with the embedded design scenarios and animations will be used by governments, planners, and the general public to identify areas of future vulnerability so that the cities may better plan and invest for the development of resilient communities from now to 2100.

KEYWORDS: Climate Change, Resilience, Sea-level-rise, Carbon-Neutral, Adaptation, AI, Machine Learning, Synthetic Biology, Robotics.

INTRODUCTION: The Design of the Crunch Integrated Decision Support System (IDSS)

PART 1: IDSS App Development

Part 1 includes the Climate Resilient Food-Water-Energy-Nexus parameters for CRUNCH Miami's primary goal of building an Integrated Decision Support System (IDSS) application. It is an nd-digital platform based on digital geographic information for carbon-neutral city scenarios that allows decision-makers and citizens of different levels of knowledge to provide consistent and coordinated support to multiple users in making different decisions (Fig. 1).

1.1. Rapid Energy and Resource Modelling with Open-Source GIS

This first test workflow was developed to calculate the Energy-Water-Food Nexus and CO₂ emissions at a municipal level using originally the Autodesk Rapid Energy Modelling (R.E.M.) techniques to create a baseline calculation from which to consider building optimizations, retrofitting, and renewable energy production in design studio experiments to aid in reaching Carbon-neutral or net-positive energy outcomes on a baseline of iterated existing and newly designed building and city scenarios from 2018 to 2100. The R.E.M. the method does not require lengthy in-depth onsite analysis of individual buildings within a municipality; rather it uses verified international industry standards, meaning cloud-based retrieved energy consumption for building typologies, zonings, schedules, materials and systems, and energy supply mix of the municipalities (Fig. 2). The second testing workflow involves understanding the various parameters of the CRUNCH Nexus for Food, Energy, and Water (FEW) such as the load and consumption quantities and profiles, population, sea-level rise, storm surges, CO₂, service infrastructures, etc. were estimated and compared with the local Florida Power & Light Company (FPL) and Miami tax appraiser summaries. In addition, to assess the possibilities of moving towards self-sufficient cities with zero carbon emissions the thermal and electrical potential of solar energy was assessed, cross-examined, and compared to the first basic workflow from 2018. The focus was on two cities - the City of South Miami and the City of South Miami Beach. Estimates and data processing for the online IDSS were done at the census block level (Fig 3), and for transparency purposes were used only open data and free tools for analysis and evaluation. The calculation was made using Python. Miami-Dade County has provided public access to 2D shape information in addition to shape files and census population data. Information about buildings belonging to the County has been imported into a platform called OpenStreetMap, which is a voluntary project similar to Wikipedia, but with spatial data and maps.



Figure 1. Right and left image; Workflow diagram of the general CRUNCH work deliverables (WP) with open source GIS into Autodesk Infraworks, Civil, ESRI ArcGIS Pro, Revit-BIM, Green Building Studio, Insight360, Dynamo, Grasshopper, Python, GeoPanda, etc. for analyzing, coding, designing, scripting, and optimizations of cities and buildings. This includes design studio scenarios from 2018 to 2020. (Source: FIU Thomas Spiegelhalter and Darren Ockert).



Figure 2. Right and left image; Workflow diagram of the open-source GIS into Autodesk Infraworks, Civil, ESRI ArcGIS Pro, Revit-BIM, Green Building Studio, Insight360, Dynamo, Grasshopper, Python, GeoPanda, etc. workflows for analyzing, coding, designing, and optimizations of cities and buildings. This includes design studio scenarios from 2018 to 2020. (Source: FIU Thomas Spiegelhalter and Darren Ockert).

This means that many of the buildings in the original dataset were updated by volunteers to be more detailed and accurate than county building data. For example, some demolished buildings have been removed, new ones have been added. Both these shapefiles were available from different sources and combined together using "spatial fusion" into one single dataset for further analysis. This permits us to make estimates at the census block level by observing the building around its perimeter. Based on the polygonal shapes of each building one can calculate the base area using the existing functions in GeoPandas. For this, the Python Sklearn library was used because height information for about 80% of buildings was available and not available for the rest. Since energy estimation requires volume information, missing data must be imputed. Machine learning was used to estimate height using the rest of the available parameters as predictors. Both these shapefiles were available from different sources and combined together using "spatial fusion" into one single dataset for further analysis. This permits us to make estimates at the census block level by observing the building around its perimeter. Based on the polygonal shapes of each building one can calculate the base area using the existing functions in GeoPandas.

For the beta version of the application, a simplified hypothesis was put forward that energy consumption is proportional to the volume of the building. In addition, city-wide energy consumption data was obtained from the Florida Power and Lighting Company (FPL), and based on this information a monthly energy consumption estimate was also created for each census site based on city-level energy consumption. Project Sunroof is an open-access Google initiative tool that offers geo-coded solar photovoltaic potential estimates. Google Earth provides high-resolution images of rooftops that were originally used in the Sunroof project to calculate the solar potential of each roof. Following the initial assessment phase, artificial intelligence was used to predict the solar system's potential: to be exact the initial estimates were used to train machine learning models that can predict solar potential based on information from Maps and Google Earth.

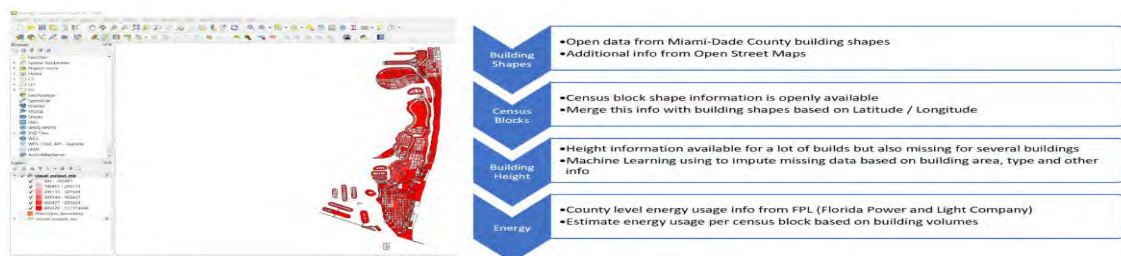

Figure 3. Left images: Visualizing the energy consumption of South Miami and Miami Beach on QGIS. Right Image: Excerpt of the Google Solar Building Potential Analysis. Right image: Workflow diagram of the second CRUNCH work deliverable (WP) with open-source Python and QGIS

1.2. CRUNCH App Data and Methods

The sea-level rise rate (SLR) is not constant around the world and shows large local variations, therefore adaptation to changes in water level and planning has a strong local component and every coastal area must take into account its own unique characteristics (IPPC, Chapter 4), (Wodinski et al.). The tool can provide estimates for each building or census location; the latter was used to determine the solar system potential of South Miami and Miami Beach at the census level and to make estimates at the census block level. Most of the solar energy incentive data are retrieved from Clean Power Research studies by federal, state, and local governments such as relevant utility websites, Renewable Energy Credit (SREC) data from Bloomberg New Energy Finance, SRETrade, and relevant state authorities, and aggregated and anonymized solar cost data from Aurora Solar software. In addition to the problems associated with sea-level rise, anthropogenic climate change also poses a risk to coastal communities of stronger storm surges (Bevacqua et al). For this reason, understanding the local impacts of climate change is critical in the cities of South Miami and Miami Beach. The estimates and data processing for the online IDSS were made at the census block level (Figure 3).

1.3. Considering and Simulating Inundation Levels

An essential step in modeling flood levels is the selection of a reference surface to compare the height or depth of the water. Tide data are locally standardized elevations recorded at specific tide phases for a specific area of the same oceanographic characteristics. The water levels were measured on the surface of the medium-high water level (MHHW), which is the average of the highest water level. A series of SLR flooding scenarios were created ranging from 30,48 cm to 244 cm increments, with the digital elevation model (DEM) derived from the 2015 Miami-Dade County LIDAR dataset, represented in the vertical coordinate system NAVD88. This area is 0.1 m below the South Florida MHHW, which has been adjusted in the calculations. The methodology is described by Zhang et al. Furthermore, relevant structures such as embankments and dams were also considered to create a hydrologically accurate model. The National Meteorological Service (NWS) model of the Sea, Lake, and Surface Hurricane Surge (SLOSH) was used to calculate floods due to category 1-5 hurricanes due to modeling uncertainties, tropical storms are not included in the application yet. The maximum flood boundary (MEOW) for the Miami basin indicates the maximum likely flood of a given storm category in the basin with a defined path and propagation velocity. Our calculations use the SLOSH output for the maximum MEOW (MOM) for the basin which takes several combinations of ground speed and trajectory for the basin into account to create a worst-case scenario for a particular storm category. At a later stage, all possible combinations of SLR scenarios and storm surges were created by adding up the appropriate flood layers (for example, it can cause more damage when it occurs in addition to already high sea levels. "However, this compound effect is complex to model and is still an open research question (Hoshino et al)."

1.4. Quantifying Social and Economic Impacts of SLR and Storm Surges

The social and economic impacts of SLR scenarios and storm surges in the cities of Miami and South Miami Beach were estimated using a GIS-based approach, using US census blocks as the spatial units. These were small enough to capture the urban structures in these cities grouped into the following categories and variables: Demography, service infrastructures, real estate, buildings, land use, and roads. Each category consists of several attributes such as racial breakdown, total assessed property value, total area by land use category, etc. Second, the flood scenarios have been converted to a binary GIS layer (i.e. As a final step the affected proposal (e.g. population). This workflow is automated using Python scripts. At the end of this step, the common and affected values of the attribute are listed, for example, as an area of residential land use and area of residential land use underwater for a scenario. This procedure was available for each block within the study area for each combination scenario from 2018 to 2100. However, there is a compound effect and it is still an open research question (Hoshino et al. 2016), which means that our approach uses a more simplistic scenario by adding these inundations together.

1.5. CRUNCH City of Miami Beach and South Miami Web application

Because effective communication of complex environmental issues is challenging, it was our goal to develop a lightweight and easy-to-use web application that displays dynamically and interactively the potential social and economic impacts of coastal floods and parameters related to food, water, and energy links within cities. Free open-source software has already been used to create interactive web GIS applications for surplus water modeling (Juhasz et al.), our application is built using exclusively open-source software to enable faster and cost-effective development. The app implements a flexible design that allows you to add and remove additional attributes at later stages of development.

1.6. Serving Data, API, and Database

The app displays two types of data: spatial and non-spatial. Non-spatial data consists of pre-calculated socio-demographic variables and parameters of the food, water, and energy chain including infrastructure, sea-level rise, storm surges, and pandemics for each quarter in the cities studied. An application programming user interface (API) is designed to display this data in a web environment by connecting to a MySQL database optimized for performance using multi-column indexes. The API accepts HTTP GET requests across six endpoints that correspond to five socioeconomic categories and parameters for the relationship between food, energy, and water. The web application makes calls to this API on request based on the census block selection, that is, for any given combination of blocks within the boundaries of the studied cities, an estimation of energy consumption, water consumption, etc. For socio-economic variables, two parameters can also be added to the SLR and storm conditions to obtain results for various combinations of SLR and storm scenarios.

1.7. Vector tiles

Managing geographic data using traditional GIS techniques can be slow due to the size and complexity of datasets. For this reason, this application uses an innovative concept and provides geospatial data as vector fields. The tile system divides the ground into spatially nested tiles with progressively smaller and more granular tiles and only transfers a portion of the original dataset. Vector tiles convey geospatial data with vector geometries that can be used in a browser for fast, dynamic viewing. Flood tiles are constructed with polygonal geometry using a technology structure. Each polygon contains two values: the minimum SLR and the storm scenario in which they were flooded. The application uses two types of tiles: inundation tiles generated from binary inundation layers and background map tiles based on OpenStreetMap (OSM) data. The appearance of objects saved as vector styles can be changed on the fly on the web map, as flood scenarios can be quickly modified by filtering out these attributes. The same flexibility applies to the background map.

1.8. User Interface

The user interface was written in JavaScript and works like a Node.js container. The user interface design was aimed at providing an easy-to-use interface that allows users to immediately see the social and economic impact of SLR floods and storm surges as well as water, food, and energy-related properties in the target cities. The interface is divided into a map viewer and a statistical report area. The map viewer provides spatial interactivity such as selection of custom areas in cities, interactive zooming, and more. Another main component of the user interface is the statistical reporting tool, which is generated using dynamically generated and updated graphs. The main function of the application is to present and view detailed information about a user-selected city area being studied.

1.9. Application functionality

The selected area in Figure 4 is highlighted in the map interface and the unselected areas are shaded; users can interactively change the selection and dynamically update the statistics in the right pane once they select an area. The beta version of the application currently shows the estimated floor space, energy consumption, CO₂, and PV potential for the selected area. Another main feature of the app is the dynamic SL display of floods and storm surges used by the sliders at the top of the map panel. Figure 5 shows a scenario for a 92 cm SLR in Miami Beach (Wowinski et al.). Socioeconomic variables corresponding to this flood level in a user-selected area are plotted on the right side of the graphs (e.g. Demographics, Property, Service Infrastructure, Land Use, and Road). Each change triggers five API parameters for loading statistics for each theme category at the application level. The information corresponding to these categories reflects the current settings (SLR, storm surge, and hurricanes) in the selected area. All selected statistical groups display information for both totals and counts or values affected, for example, changes in flood level settings. Changes in inundation level settings and area selection are instantly reflected in both the map and statistics panes (Zhang, et al. 2011).

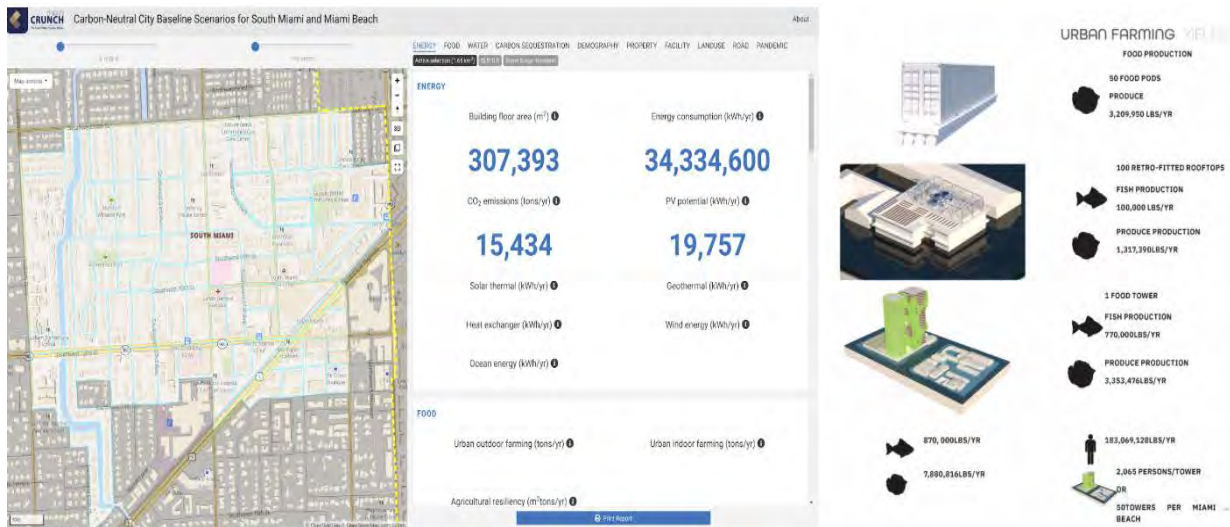

Figure 4. The user interface of the application shows an interactive selection (highlighted on the map) and related statistics on the left and on the right estimates for urban food farming. (Source: Prof. Thomas Spiegelhalter, Dr Juhasz Levente).

This includes area selection that is immediately reflected as this dynamic relationship allows users to explore and study the potential impacts of climate change and gain insights into the energy-food-water relationship. To improve performance, data caching is also implemented so that one can view previously loaded scripts without reloading data through the API. Several other features have also been implemented to assist in the interpretation of the results. For example, the size of a selected area is calculated dynamically and displayed in the interface. In addition, the highlight of a corresponding category on the map will also highlight the category in dark brown on both the map and the maps. The WebGL technology used in this application also supports 3D rendering and the view can be shifted and rotated freely. Currently, buildings are displayed with the correct height as shown in Figure 5. An export function has also been implemented that dynamically generates and loads a PDF document with the current settings. This report also contains additional data tables and explanations to help interpret the results, in addition to the map and graphs shown in the appendix.

Part 2: How to mitigate SLR and Storm surges in the age of disruptive technologies and climate change from now to 2100?

In the next 80 years, we will encounter many disruptive technologies and innovations that will sweep away the city and building systems or habits it replaces because it has attributes that are recognizably superior throughout the lifecycle of a project. The recent most disruptive technology examples that have been applied for the CRUNCH research are a mixture of artificial intelligence, automation with robotics, avatars, synthetic biology, smart sensor infrastructures and materials, nD printing, VR/AR, and IoT. More will follow. Other innovations imagine carbon-positive high rises with green-blue infrastructures for Miami that absorb atmospheric carbon and generate biofuels using new technologies like direct air-capture through multilayered facade tectonics. In summary, all the envisioned CRUNCH projects will be transforming all types of lifestyles, jobs, and industries.

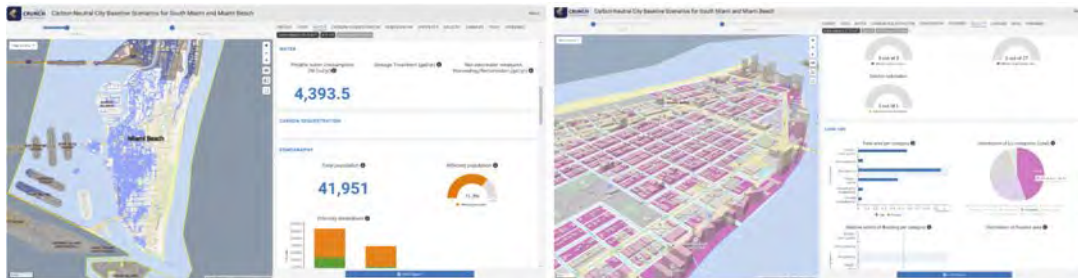

Figure 5. Left image: The user interface of the application dynamically visualizes 90 cm of SLR and reports potential impacted resident demographics. The right Image User interface in 3D mode shows a perspective view of Miami Beach. (Source: Thomas Spiegelhalter, Juhasz Levente, FIU-CRUNCH, <https://slr.fiu.edu/CRUNCH/>)

Since fall 2018, over 120 students in the FIU CRUNCH research studios have worked on a number of carbon-positive design scenario projects for the city of Miami Beach and the city of South Miami. Only a couple of selected experimental designs can be discussed in this paper. Most of the selected designs represent 10 m above the current sea level elevated 2100 high rise community scenario designs, that are self-sufficient, off the grid, and multifunctional floating structures. (Figure 6).

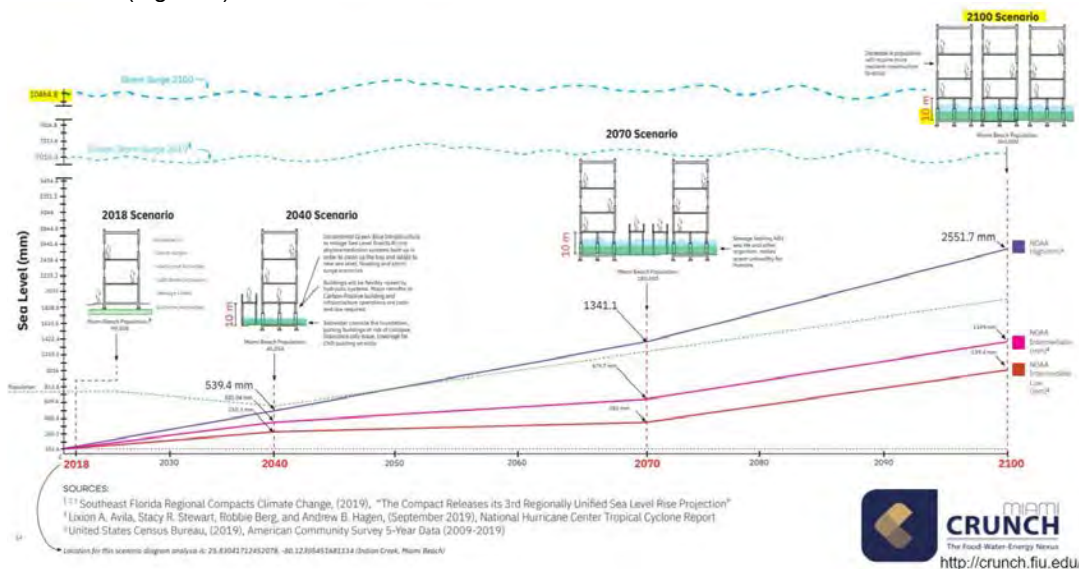

Figure 6. Image captions above shows projected Sea Level Rise and hypothetical population change scenarios from the baseline 2018 (90.108 ppl.), to 2040 (45.054 ppl.), 2070 (180.000 ppl.), and 2100 (360.000 ppl.). (Source: CRUNCH PI-Team of Prof. Thomas Spiegelhalter, 2018-2022).

2.1. IDDS Interactive SLR and Storm Surge Beta App with Design Experiments from 2018 to 2100

The SLR and 2018 to 2100 scenario diagram above show projected Sea Level Rise and hypothetical population change scenarios from the census baseline 2018 (90.108 ppl.) to 2040 (45.054 ppl.), 2070 (180.000 ppl.), and 2100 (360.000 ppl.) The scenarios are based on incremental green-blue infrastructural and building adaptations to SLR, clean-ups of contaminations and sewage spills with phytoremediation techniques and microbes. The design experiments incorporate hydraulically raised and just in time adaptable new buildings and infrastructures. The new service infrastructure and buildings' ground levels are calculated and suggested for 10 meters above mean sea level. This calculation is based on SLR projections and the Hurricane 5 Dorian precedent including NOAA research forecasts and measurements, the US census bureau, and the Southeast Florida Regional Compacts Climate Change Statistics from 2019. The location for this scenario diagram analysis is Indian Creek in Miami Beach (25.83 -80.123).

All the linked design structures have been modeled using generative and topological optimization workflows of Dynamo-Python-Grasshopper-Revit-BIM-Infraworks, InventorPro, Fusion360, Rhino, GBS/Insight360, and COVE-AI, software workflows with Computational Fluid Dynamic analysis tools for hurricanes and storm surge scenarios.

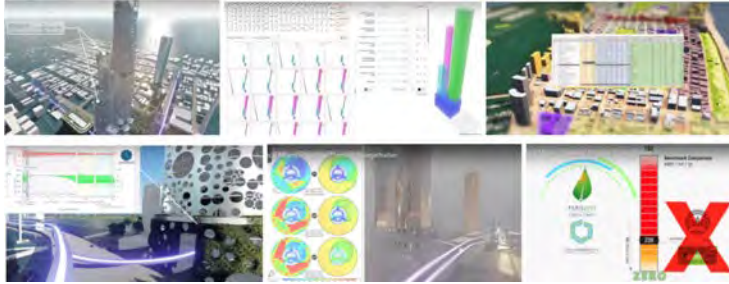

Figure 7. Image captions above show the featured hypothetical scenarios for the Miami Beach Dynamo-BIM script and node workflow for a test series of carbon-neutral facade/shape/orientation and blue-green infrastructure contexts. Image captions below show scenarios with WUFI temperature, vapor migration, and humidity simulations.(Source: Master Thesis Studio Prof. Thomas Spiegelhalter, Sadiel Ojeda)

All design typologies are demonstrating parametric resilient geometries with real-world engineering applications, and feature potential upcoming disruptive technologies and innovations in the area of the F-W-E-Nexus. The scenarios include multi-functional systems, modules, and renewable energies from solar/wind/water/kinetic building skins, autonomous transportation, artificial intelligence, deep neural networks, the internet of things, robotics, and urban outdoor and indoor farming with self-healing facade tectonics for climate emergencies in 2100. (Figure 7,8,9). The best CRUNCH Design Studio research projects from Fall 2018 to Fall 2021 are published with FrancoAngeli in Milano-Rome and Routledge, USA and are also considered in the new IDSS beta application as selectable, adaptive scenario models and solutions to combat SLR. (Figure 8).



Figure 8. Above book cover excerpts of the four Volumes 1 to 4 publications on the Food-Water-Energy-Nexus featuring CRUNCH design research projects from Fall 2018 to Fall 2021. (Source: Prof. Thomas Spiegelhalter, FrancoAngeli, Milan-Rome).



Figure 9. All three images show two joint FIU Spring 2020-Spring 2021 experimental, carbon-neutral high rise design studio projects of Spiegelhalter-Andia (SP 2020) and Spiegelhalter-Galanos (SP 2021) envisioning a series of islands with high rise buildings along the I95 freeway of Biscayne Bay between Miami and Miami Beach. Designs by Alexander Bahensky, Patrik Osvaldo Laura Gomez and Sophia Neves (Source: Crunch Studios 2020, 2021).

One of CRUNCH Miami's most successful master thesis is the American Institute of Architects (AIA) MIAMI 2020 Design award-winning project by Master Thesis Student Amalia Tomey of the Studio Thomas Spiegelhalter in June 2020. This case study is sited in Miami downtown for a highrise building scenario. Using the Urban Living Lab (ULL) approach, it addresses dynamic changes in sea level rise, storm surge, adaptive building structures for Renewable Energy, Water, and Food Nexus using the Urban Living Lab (ULL) approach. The ULL of the CRUNCH IDSS provides data and mapping baseline for the city's needs in 2100, developing tools and framework, testing and analyzing data-driven models using different self-sufficiency strategies, carbon-positive, and resilient scenarios from now to 2100. (Fig. 10).

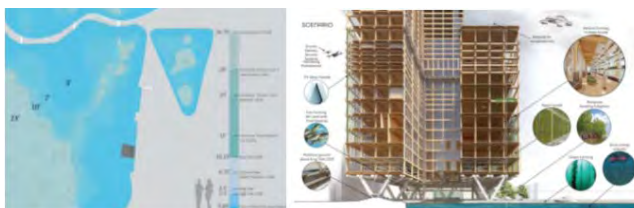

Figure 10. American Institute of Architects (AIA) MIAMI 2020 Design Award project by Master Thesis Student Amalia Tomey of the CRUNCH Design Studio Prof. Thomas Spiegelhalter in June 2020. (Source: Thomas Spiegelhalter, Amalia Tomey).

Another CRUNCH design studio project by Ramses Allende, Diana Vazquez, and Daniel Calero was recently awarded by AIA Miami in October 2021. This mixed-used, self-sufficient, carbon-neutral, off-the-grid highrise scientific community proposal for the year 2100 incorporates all aforementioned disruptive technologies systems and program schedules for lab-grown food production, industrial 5.0. robotic productions and automation, residential, offices, entertainment, recreation, education, medical labs, and sanitation. (Figure 11)



Figure 11. American Institute of Architects (AIA) MIAMI 2021 Design Award project by Ramses Allende, Diana Vazquez, and Daniel Calero of the CRUNCH Design Studio Prof. Thomas Spiegelhalter in Spring 2021. (Source: CRUNCH Studio Thomas Spiegelhalter).

Part 3. Towards a Synthetic Biology Inspired Renewable Resource Abundant Society

3.1. Design Coding Experiments with Natural and Synthetic Biology Growth Computation

Synthetic biology is a dynamic, young, ambitious, and diverse scientific discipline. It is in constant development and change, making social appreciation of this emerging science challenging and “subject to misunderstandings.” Our research question for Part 3 is: Could further research in this area of synthetic biology help protect low-lying urban communities in Miami from the elements? How can we study and integrate molecular modeling, cloud computing, biophoton imaging, and bioengineering nodes and scripts programmed for synthetic biology to develop growing structures between today and 2100?

3.2. Circular Metabolic and Resilient Biscayne Bay Island Bio-Design Workflows

Our research explores useful open-source software and scripting tools to approach this complex and evolving area. The toolkit provides biological access exploring “layered” model scenarios that describe the relationship of synthetic or semi-synthetic organisms and cells to the natural organisms, derived from evolution and hopefully applicable to architecture. It is also a key issue on length scales from nanometers (nm) to kilometers (km) and a development time issue from bioengineering to living infrastructure, including sensing, maintenance, and renewal of resources and systems or repair. We will discuss two projects; One is a speculative project by the joint Spring 2020 research studio of Spiegelhalter-Andia which continued an earlier studio investigation of a series of islands growing in Biscayne Bay. The vision was redesigning the well-known cyanobacteria biological cycle capturing carbon dioxide from water through photosynthesis and convert it into fine-grained rock material, which was abundant during the Precambrian period.

This project as mentioned earlier led to a further investigation with new carbon-positive high-rise typologies in the joint CRUNCH studio of Spiegelhalter-Theodoros in Spring 2021. For the generative design iterations, we used BIM-Grasshopper plugins for agent-based modeling based on Physarum polycephalum. It is a stigmergy algorithm similar to an ant colony algorithm. Physarum polycephalum is a slime mold that inhabits shady, cool, moist areas, such as decaying leaves and logs. Physarum polycephalum is one of the easiest eukaryotic microbes to grow in culture, and has been used as a model organism for many studies involving amoeboid movement and cell motility. As an analogy to design efficiency for circulation patterns, when grown in a maze with oatmeal at two spots, P. polycephalum retracts from everywhere in the maze, except the shortest route connecting the two food sources. English computer scientist Jeff Jones adopted a synthesis approach and a mobile multi-agent system with very simple individual behaviors employed.



Figure 11. All three images show the joint Spring 2021 studio agent-based modeling scripting based on Physarum Polycephalum by Studio Thomas Spiegelhalter and Theodoros Galanos envisioning a series of highly efficient connected circulation sequences and transportation networks for the new grown islands along the I95 freeway of Biscayne Bay between Miami and Miami Beach. (Source and Images by CRUNCH Studio Spiegelhalter-Theodoros, 2021).

3.2. A Mycorrhizal Network for the Transformation of the Port of Miami in 2100

The second selected design is the current Fall 2021 CRUNCH project development scenario for the flooded Port of Miami area in 2100. According to the interactive Google SLR map, the port of Miami will be underwater by 2,55 meters or by 90% and prone to soil subsidence in 2100. After 80 years, the design research team sees a need for dynamically flexible structures that work in symbiotic networks, including living systems to transform the flooded Port of Miami. It includes incremental

adaptation for new green-blue infrastructures, innovative, disruptive typologies of natural, renewable, resilient resource flows for cargo, passenger, and civil transportation nodes and networks.

A new port of growing tectonics with built-in solar systems to collect and produce energy in the form of liquid fuels, just like green leaves of plants, as an alternative to burning fossil fuels. The CRUNCH research team studied Mycorrhizal Networks with multiple fungi that encapsulate long thread-like structural sound roots that reinforce over time caused by dynamic environmental load conditions. For example, mycelium is a long thread-like geometry and is an entirely biodegradable material with extraordinary properties. Using mycelium with synthetic biological coding could benefit the local environment, while indoor and outdoor urban gardens and agriculture provide food for building occupants. In addition, these embedded mycorrhizal networks connect individual plants to carry water, nitrogen, carbon, and other minerals. It breaks down organic materials and makes their raw materials available for circular and metabolic use in the new envisioned infrastructural self-sufficient highrise communities (Figure 12).



Figure 12. Images by the CRUNCH Fall 2021 Midterm designs by Gianna Martinez, Maria Pardilla, Soroya Friedwald, Mycorrhizal Network Design Sequence for the Miami Harbor. (Source: CRUNCH Research Studio Thomas Spiegelhalter, Fall 2021).

Mushrooms within mycorrhizal networks function like the Internet of the forest, helping plants communicate with each other using mushroom strands (mycelium) on the forest floor. One of the most common mutualistic relationships involving fungi is mycorrhiza (fungi and plant roots) that serve here as a design precedent and driver for creative thinking, envisioning, coding, and scripting new building designs for 2100 and beyond.

CONCLUSION AND FUTURE WORK

Architects often fail to adequately explore alternative resource efficiency options for their impact on the environment, energy, water, and resource consumption to reduce greenhouse gases in advance. This leads to an alarming literacy that presents a dilemma in the architecture, engineering, and construction industries. Any integrated project implementation process for carbon positive design scenarios should require cloud-based collaborative master planning with machine learning and deep neural learning processes for feedback across all project domains, coding, scripting, interaction between different expert domains and pluggable platforms, for sharing, cloud modeling, intensive analysis, and suitability testing processes. Our critically discussed cloud-based automated optimization analysis and workflows, with experimental design testing including synthetic biological research and the development of the IDSS platform, are critical to challenging our imaginations as to how we can mitigate the impact. Climate change, resource scarcity, sea-level rise, saltwater intrusion, tropical cyclones, extreme rainfall, and increased latent heat. Our research, analysis, and test conclusions are still in a test phase, and we continue to ask and validate how will innovative, blue-green and resilient, zero-emission, AI-powered infrastructure for coastal cities in 25, 50, or 80 years look like?

ACKNOWLEDGMENTS

We want to thank all D7, 8, 9, 10, and master students of the FIU CRUNCH research studios; all CRUNCH team members <http://crunch.fiu.edu/about/team/>, for their assistance and contributions. The majority of this material for the case studies is based upon work supported by the EU BELMONT, Intelligent Europe, US National Science Foundation (NSF) under Grant No. 730254. Any opinions, findings, and conclusions or recommendations expressed in this material are those of the authors and do not necessarily reflect the views of NSF or FIU in Miami.

REFERENCES

- Bevacqua, E., Maraun, D., Voudoukas, M., Voukouvalas, E., Vrac, M., Mentaschi, L., & Widmann, M. (2019, Sep 18). Higher probability of compound flooding from pre-cipitation and storm surge in Europe under anthro- pogenic climate change', *Science Advances*, *Science Advances*, 5(9). <https://doi.org/10.1126/sciadv.aaw5531>
- Hall, J. A., Weaver, C. P., Obeysekera, J., Crowell, M., Horton, R. M., Kopp, R. E., Marburger, J., Marcy, D. C., Parris, A., Sweet, W. V., Veatch, W. C., & White, K. D. (2019, 3 4). Rising Sea Levels: Helping Decision-Makers Confront the Inevitable. *Coastal Management*, 47(2), 127-150. <https://doi.org/10.1080/08920753.2019.1551012>
- Hoshino, S., Esteban, M., Mikami, T., Takagi, H., & Shibyama, T. (2016). Estimation of increase in storm surge damage due to climate change and sea level rise in the Greater Tokyo area. *Natural Hazards*, 80, 539–565. <https://doi.org/10.1007/s11069-015-1983-4>
- Human embryonic stem cells integrate successfully into mouse brain.* (2005, Dec 12). Salk. Retrieved Oct 23, 2020, from <https://www.salk.edu/news-release/human-embryonic-stem-cells-integrate-successfully-into-mouse-brain/>
- Juhász, L., Podolcsák, A., & Doleschall, J. (2016, Aug 12). Open Source Web GIS Solutions in Disaster Management – with Special Emphasis on Inland Excess Water Modeling. *Journal of Environmental Geography*, 9(1-2), 15-21.
- Roosth, S. (2017). *Synthetic: How Life Got Mad*. The University of Chicago Press.
- Wdowinski, S., Bray, R., Kirtman, B. P., & Wu, Z. (2016, June). Increasing flooding hazard in coastal communities due to rising sea level: Case study of Miami Beach, Florida. *Ocean & Coastal Management*, 126, 1-8. <https://doi.org/10.1016/j.ocecoaman.2016.03.002>
- Zhang, K., Dittmar, J., Ross, M., & Bergh, C. (2011). Assessment of sea level rise impacts on human population and real property in the Florida Keys. *Climatic Change*, 107(1), 129–146.

Spatial Appropriation During the Pandemic: Analysis of Two Parallel Cases

Carey Clouse¹, Caryn Brause¹

¹University of Massachusetts Amherst, Amherst, MA

ABSTRACT: The pandemic moved many socializing and recreation spaces outside, as individuals and groups sought to comply with COVID-19 indoor space mandates and closures. These Third Places became enlivened with new uses, and many transformed to accommodate new human needs and social distancing practices. This paper analyzes two parallel cases from Eugene, OR and Northampton, MA to identify common and divergent trends in use and behavior. Using Gehl Institute tools and field observation, data collected in the summer of 2021 revealed not only shifts in use, but also pertinent demographic differences. Use of the two spaces differed according to time of day and type of group, and was improved or hampered with spatial design features. Finally, the Right to the City theoretical framework is applied to these two cases in order to identify the ways in which spatial appropriation, particularly during a global pandemic, may have long-term opportunities and consequences for urban Third Places.

KEYWORDS: Third Places, pandemic, COVID-19, urban space, spatial appropriation

INTRODUCTION

In March 2020, the World Health Organization declared COVID-19 a global pandemic. Many municipalities immediately took measures to promote the safety of citizens, including temporarily closing bars, restaurants, non-essential retail stores, and many entertainment venues. Beyond the loss of employment, economic activity and access, people across the US witnessed the abrupt removal of the types of locations that support in-person socializing, economic opportunity, and recreation. Many indoor and outdoor public spaces that are central to the vitality of cities and urban dwellers were shuttered. In their place, outdoor spaces with social and recreational opportunities became appropriated by individuals and groups, often in new and compelling ways.

This paper identifies two outdoor sites in two distinctive American cities, one small, one mid-size, noteworthy for their transformation under the 2020-2021 COVID-19 pandemic. Major shifts to the physical makeup and social use of these outdoor spaces were observed during the course of the pandemic, with both positive and negative outcomes for communal life. While these two locations became adapted to an assortment of new pandemic needs in fundamentally different ways, both responses showcase the creativity, and limitations, of spatial appropriation solutions and in turn, reveal new directions for design thinking in response to major public health crises. Moreover, some of the positive outcomes resulting from this unprecedented time period might also offer design guidance for a post-pandemic era, with broader implications for the disciplines of urban design and planning.

1.0 LITERATURE REVIEW: THIRD PLACES

Sociologist Ray Oldenburg's (1989) notion of "third places" has received both popular and scholarly attention and provides a sensitizing lens for considering pandemic-related spatial adaptations. Third places are conceived as spaces in the public realm that foster community and communication among a wide range of individuals outside of their private spheres of home and work. Because they are publicly accessible, provide a neutral common ground, and promote regular, open and visible interaction, the role of third places is well established in contributing to communal vitality, building social capital, and increasing sense of belonging, thus contributing to quality of life (Jeffres et al. 2009). According to Oldenburg, third places provide opportunities for social mixing, which is foundational to a functioning democracy, while Setha Low (2020) suggests that they are a complement to public spaces in which we may encounter, or even come into conflict, with a wider range of mostly unknown people.

Even before the pandemic, researchers documented trends demonstrating the widespread closure of third places in the U.S., and the associated perils of losing these sites of social engagement (Finlay et al., 2019; Yuen et al., 2017). During the pandemic, indoor third places virtually disappeared, and while many activities were re-tailored for outdoor access (Ross, 2021), many of the more democratic and publicly accessible spaces also functionally disappeared due to perceived dangers about coming into contact with infected individuals (Low and Smart 2020). While outdoor third places gained immense popularity and interest during the pandemic (Cutrara, 2020), parks, plazas and trails also became sites of multifunctional opportunism (Low 2020).

The closure of indoor third places may threaten social cohesion (Low, 2020; McCunn, 2020; Volpe, 2021) and the potential for the loss of old ways of operating in both indoor and outdoor third places is a major challenge for planners today (Low and Maguire 2020). However, researchers have expanded upon Oldenburg's (1989) conception of third place--- beyond romanticized notions of public space--- to consider how social dimensions can be inclined towards inclusion rather than marginalization (Yuen and Johnson 2017). As North American design and planning practitioners evaluate the adaptation, alteration and increased use of public outdoor spaces during the pandemic, perhaps even responding with more permanent solutions, there is an opportunity to foreground inclusivity into future discussions and designs for third places (Doctoroff 2021).

2.0 METHODS

This paper employs an observational and analytic approach to understand the shift in public space usage during the COVID-19 pandemic. Observational methods have been used to study human behavior in public space, perhaps best illustrated by the videos of William Whyte in the 1970s, which led to his book *The Social Life of Small Urban Spaces* (Whyte 1980). Today, non-profit organizations such as the Project for Public Spaces carry this work forward by engaging with communities on placemaking initiatives.

2.1 Public Life Tools

For this study, the Gehl Public Life Tools ("How to Use the Public Life Tools," n.d.) were used to conduct field studies of the two sites and their surrounding contexts during the summer of 2021. The Gehl methodology is an appropriate fit for this comparative study as the tools are easy to implement in real-world scenarios and the data collected comprise physical, social, and intangible qualities of public space. Moreover, the findings have both theoretical and practical implications. Two primary tools were selected to survey the adapted spaces and the public life taking place in them during the pandemic: the Age and Gender Tally Tool and the Stationary Activity Mapping Tool.

The Age and Gender Tally (<https://gehlpeople.com/tools/age-gender-tally/>) is a method for recording how many people occupy and use a public space at specific times, along with estimates of their age and gender. When employing this tool, populations observed are grouped into five age brackets: Infants and Toddlers (0 to 4 year olds), Youth (5 to 14 year olds), Young Adults (15 to 24 year olds), Adults (25 to 64 year olds), and Seniors (65+). Although general, gathering basic data can help planning and design professionals accommodate the needs of groups who are sometimes overlooked, for example, women, youth and the elderly (Marcus and Francis 1998, Gehl and Svarre 2013). For this bounded study, the data was, by necessity, externally gathered; age and gender were not validated through self-reports by those observed. However, even observationally, it provides some metrics about who is actively inhabiting and using the space, and who is not, in order to preliminarily assess whether the space is inclusive, welcoming, and accessible to a broad range of people.

The Stationary Activity Mapping Tool (<https://gehlpeople.com/tools/stationary-activity-mapping/>) documents what kinds of activities people are doing in a space at a given time. Knowing what types of activities are occurring can help planning and design professionals (as well as owners, clients and municipalities) determine whether the site's physical infrastructures are meeting the needs of its activities and supporting its social life. The Stationary Activity Tool groups activities into walking, standing, sitting, and playing, however, the activities in each space recorded may be far more numerous and these activities may overlap and be contemporaneous. The diversity of activities in a particular place may contribute to social mixing through active or passive contact and shared experiences (Whyte 2010, Gehl and Svarre 2013). For this study, the tool was modified to capture gradations of behavior at the two sites. For example, at the College Hill Reservoir 607 a broad variety of types of recreational activities were observed, often occurring simultaneously, and in close proximity. By contrast, at the Strong Avenue site, activities were primarily commercial in nature, so mapping included whether people were sitting alone, with one other, or in groups, as well as whether they were working, eating/drinking, watching live music, or not participating in commercial activity. Qualitative observations were also collected during the mapping periods to produce more detailed description of the participants and their activities.

2.2 Research Questions

The literature review focused on third places, and led the team to ask the following research questions:

Given the improvised nature of pandemic public spaces, are they inclusive and accessible to a broad range of people? What kinds of activities do they support?

Might these appropriated public spaces serve as new third places? Do they appear to be 1) publicly accessible, 2) promote regular, open and visible interaction, 3) serve as social integrators/levelers, and 4) contribute to communal life?

These questions suggest that a study of COVID-era public space adaptations could advance our understanding of how these transformations might contribute to the critical task of rebuilding communal life after the disruption of the pandemic. Assessing these spaces for their capacity to serve as pandemic third places, could potentially yield design recommendations for the post-pandemic future.



Figure 1 College Hill Reservoir 607, Eugene, OR. Source: (Authors 2021)



Figure 2 Strong Avenue Pandemic Makeover, Northampton, MA. Source: (Authors 2021)

2.3 College Hill Reservoir 607, Eugene, OR

The College Hill Reservoir 607 (Figure 1) is a historical infrastructural feature in central Eugene, OR. The space consists of a 2.5 acre paved surface at ground level, covering a gravity-fed water system that is closed to visitors, and a park-like perimeter of grass and trees. Because it is owned and operated by the private water utility, the use of the space as a public park has operated at the discretion of the owner. However, even without invitational signage, the reservoir hosts a wide variety of events and visitors, primarily social and recreational in nature. During observations, people were seen walking dogs, golfing, video-chatting while picnicking, practicing emergency communication drills, playing team sports, taking classes, practicing skills and playing. The compressed central space provided by the reservoir enables a flat area for many different activities. However, the lack of signage, rules, and specific zones or areas also suggested that there might be friction in the daily, improvisational use of this common landscape.

Observational methods incorporating the Gehl frameworks involved visits twice a day, at 8-9am and 7-8pm, for just over one week in July. Several missing sessions were made up the following week. This strategy was selected in an effort to get a detailed picture of the difference between morning and evening, and significant differences between days of the week. However, the researcher had also visited the site for weeks and even years previously, and could identify ways in which the data from July differed from previous months. For instance, the reservoir was closed entirely to the public during the week of the 4th of July, and a major heatwave occurring during this observational period reduced overall activity on the reservoir.

2.4 Strong Avenue, Northampton, MA

The remodel of the 0.7 mile long stretch of Strong Avenue (Figure 2) included subdivided areas for five establishments: a locally owned burger restaurant, a farm to table tapas restaurant, an upscale American “grille,” a brewery, and a specialty coffee shop. The four restaurants line Strong Avenue, some with additional outdoor sidewalk and alley seating; the brewery is located around the corner but set up a pop-up location for the summer serviced by 16-foot cargo trailer that was converted into a rolling tap wagon. The expansion into Strong Avenue provided each establishment with outdoor seating for 30 to 40 patrons. Additionally, there was a restaurant on the corner with outdoor sidewalk seating that expanded by two tables into the closed street but did not appear to be part of the overall collaboration. The two ends of the street were blocked by orange cones and concrete jersey barriers to prevent vehicular traffic, but an arched iron gateway with flowers invited pedestrians to enter. The sections were demarcated by potted plants, which created the central public walkway. Each establishment provided their own furnishings including tables, chairs, and, in some cases, umbrellas. When they were not in operation, some of the establishments removed the furnishings, leaving some areas empty.

Each of the establishments had different hours of operation and were busier at different times of the day and week. Observations, conducted over a three-week period in July 2021, thus followed suit in order to capture a range of experiences. Overall, (12) hours of observations were conducted: half of the hours were conducted in the morning, ranging from 9am - 11am; half of the hours were conducted in the afternoon and evening, ranging from 3pm to 9pm. Google’s Popular Times algorithm was used to identify the busiest hours for each establishment in order to document and capture the impact of the street closure on public life. Live music was scheduled for three evenings each week, so observations were conducted to compare and contrast evenings with musical performances from those without.

2.5 Limitations

Several limitations should be noted with respect to this study. First, studying two dissimilar sites provided distinct insights, but further research at a wider range of sites with differing qualities and populations is required to make broader claims about the role of public spaces during the pandemic. Second, while the Gehl Public Life Tools provided a way to measure who was using the sites and in what activities they were engaged, observations provide only one metric for evaluation; in depth interviews would be required to assess the meaning of the sites for users. Third, while the hours selected for observation were based on understandings of site activity, they capture only a snapshot of the active site use, during one season (summer), and at a time when populations were already being vaccinated and thus may have begun to have access to additional safe social spaces. Finally, the authors did not have access to data concerning use prior to the pandemic with which to compare these observations.

3.0 FINDINGS

3.1 College Hill Reservoir 607 Population

The participants viewed during observations reflected the broader population of Eugene, OR. Race, political and socioeconomic data were not collected, but age and gender tallies appeared to track the population generally, with no single group visibly missing representation (Figure 3). While the data showed active use from all age ranges and genders, participants appeared to be similarly grouped according to activity- parents supporting children, young women playing roller derby, middle aged male hockey players, young adult skate boarders, and older tai chi students. In all of the observation sessions, these groups retained their independence while sharing space with incredible fluidity. There was a notable difference throughout the day of types of people using the reservoir; for instance, very few young people were seen using the space in the morning hours, while many in this age group were seen using the space in the evening

hours. While gender is an imperfect metric, especially without verification, women nominally exceeded men in every age category, except for elders, and then, only in the morning. The free cost and open public access to the space may contribute to the reservoir being inclusive and accessible to a broad range of people, as a third place.

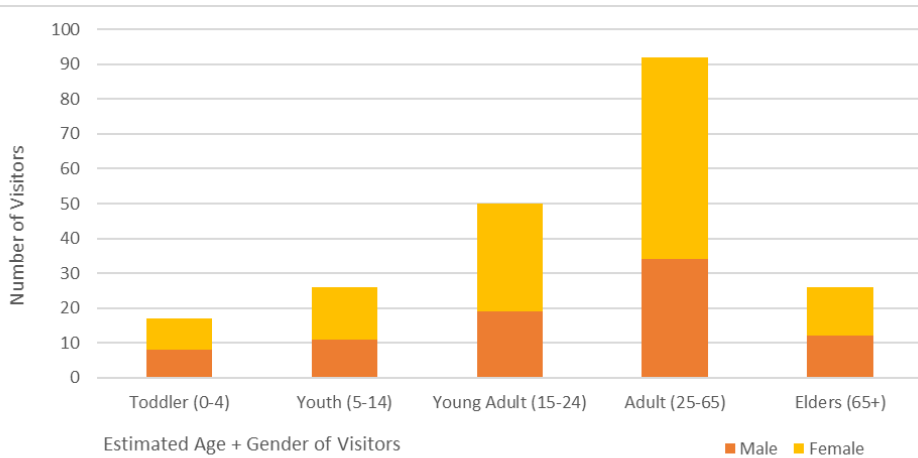

Figure 3: College Hill Reservoir: Tally of Estimated Age + Gender of Visitors

3.2 College Hill Reservoir 607 Activities, Programming and Amenities

At College Hill Reservoir 607, the limited amenities provided on site, and associated programming, nevertheless enabled a surprisingly expansive array of recreational and social activities. People brought their own gear, and they came prepared: with chairs, recreational equipment, music, food and even tents. During the observation period a total of nine different recreational activities were noted, including rehabilitation walking, jogging, roller skating, hockey playing, skateboarding, bike riding, scooter riding, tai chi or tai bo, and playing baseball. Many of these activities were also social in nature, and people brought chairs, food and music, while standing, sitting and picnicking. In addition to several classes and the monthly meetings of the Eugene Astronomical Society, groups used the reservoir for specific uses. One example observed was the Friendly Area neighborhood disaster preparedness group practicing radio communications, which involved setting up radio gear, antennas, and a tent. However, the dominant type of activity at the reservoir involves recreation, and so as a third place, it should be characterized by this type of use.

3.3 Strong Avenue Population

Employing the Gehl Age and Gender Tally Tool revealed that the population making the most use of Strong Avenue were primarily adults in the 25-64 year old age bracket. Overall, the proportion of adults far outstripped all other groups combined, likely because of the expense of the commercial establishments supporting the street makeover (Figure 4). The observational data also showed active use from younger adults and seniors. There were some notable differences in use by different populations throughout the day, and especially in populations observed on evenings with music events and on evenings without.

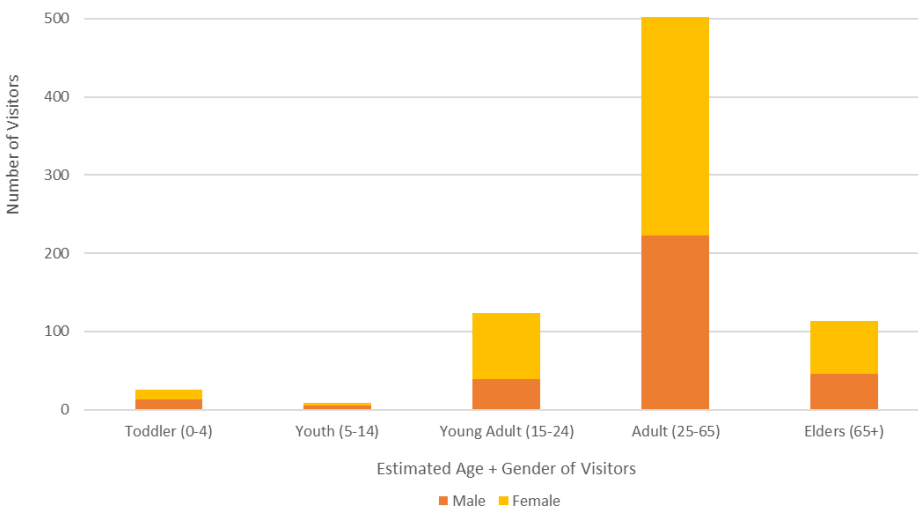

Figure 4 Strong Avenue: Tally of Estimated Age + Gender of Visitors

Overall, the Strong Avenue makeover did not seem to provide a place that was welcoming for families with young children. A few families brought toddlers and babies in strollers to the cafe in the morning or to hear music in the evening, but families were not observed gathering here, except to eat at the burger restaurant. There was a notable difference throughout the day of different age groups visiting the area's establishments. For example, young adults, particularly women, were observed in much higher numbers during the morning at the coffee shop; they were often observed meeting one other person or gathering in small groups at that time. By contrast, seniors, particularly women, visited Strong Avenue in much larger numbers in the evenings, even more so on nights with music events. While gender is an imperfect metric, especially without the verification of self-reports, the proportion of women who visited during the observations was equal to or greater than that of men. However, while adult women and men were observed in roughly equal numbers during the morning, adult and senior women were observed in much larger numbers in the evening.

3.4 Strong Avenue Activities, Programming and Amenities

Strong Avenue was primarily designed to support the adjacent collaborating businesses. Thus, there was a limited range of activities observed as the dominant amenities were deployed to activate private commercial activity. However, the site activities, populations, and observed behavior varied considerably on the three nights observed when music performances occurred. These events were scheduled for three times a week during the summer - Wednesdays and Thursdays evenings, and Sunday afternoons. These evenings were quite lively compared to evenings without music: on the two weeknights observed, the brewery, the grille, and the burger place were bustling with every available seat taken. Moreover, many non-customers came and brought chairs and even small tables; these visitors congregated in a very small dedicated public area or in an area of the street reserved for the coffee shop which removed its furnishings during non-open hours. Other non-customers lined the curbs, sat on nearby stoops, and leaned against adjacent buildings to listen. A few individuals and couples even danced. On typical evenings, few people seemed to stroll along Strong Avenue; passersby seemed to have a purpose, moving at a rapid pace from their cars parked in the at the far end of the street (past the barricade) to Main Street or vice versa. By contrast, on nights with music events, this steady stream of passersby stopped, lingered, and stood or sat down to listen to the music for a while before continuing on. Similarly, the liveliness and street activities observed during the evenings with music dissipated at other times. During regular hours, only a few of the establishments were open and, when closed, most of the businesses stored their furnishings - the tables, chairs, and umbrellas that provide texture to the street - alongside or behind their buildings; the resultant empty cordoned off street felt vacant and off-putting. Moreover, these vacant areas were not conducive to public use as signs indicated that each demarcated section, and the attendant furnishings were for customers only. The amount of seating remaining was not always enough for the open establishments' customer base. For example, the burger restaurant which was often the only open establishment, frequently had more customers than seating; the overflow guests were observed migrating to stoops or the curb to eat or, on limited occasions, seen sitting at the tables in the section of the closed brewery, who left their seating out.

4.0 DISCUSSION

The two sites studied experienced increased use, and interest, during the pandemic period, likely because people sought out outdoor spaces in response to social distancing mandates. College Hill Reservoir 607 stands out for providing vital third place characteristics without explicit programming or evidence of design measures to support intentional community building. The site appears to be predominantly a utilitarian infrastructure in its paved expanse, and yet this surface is its main attraction. The expanse of concrete draws out particular recreational activities that might otherwise be underserved in the city. For instance, hockey games, roller skating, skateboarding, practicing bicycle or unicycle riding, scootering and martial arts all benefit from the clear paving surface set apart from cars. These activities then enable outdoor social mixing, bringing together people in a third place to socialize and practice. During the pandemic, this site became particularly valued as an outdoor outlet for recreation, as city parks and indoor recreation spaces closed. As a third place, the accessibility of the site throughout the pandemic, and its characteristics of allowing for flexible use contributed to a thriving community scene.

Overall, Strong Avenue was observed to provide an uneven experience with respect to its capacity as a third place. The makeover provided a welcome and safe alternative to closed indoor third places, particularly those that are already commercial in nature. Although many of this small city's establishments were able to extend their outdoor seating during the pandemic by a few tables here and there, few were able to create quite as large and varied an area as the collaboration that reconfigured this city block. At its most active times, such as during the busy morning coffee hours and the lively evening musical events, Strong Avenue provided an animated gathering spot for spontaneous, and planned, social interaction and enhanced the quality of life in the downtown area (Oldenburg 1989; Jeffres et al. 2009). While the private commercial nature of the street makeover presented economic barriers to participation, the music events were more accessible and inclusive, drawing a significant crowd of non-customers and supported regular visible interactions by expanding the range of activities. That the events, rather than the spatial design, most visibly contributed to the creation of Strong Avenue as a pandemic third place, suggests that the site design might be adapted in future years to more powerfully contribute to communal life.

5.0 IMPLICATIONS FOR SPATIAL RIGHTS

One of the singular attributes of the two sites studied is the evidence of spatial appropriation of semi-public space. Under the constraints of the global pandemic, municipalities, communities, businesses, and individuals found that they needed to create outdoor recreation and socialization opportunities, often carving these areas out of extant urban streets, sidewalks, parks, and previously unused sites. These appropriations have been cheered by planners and urbanists. However, the speed at which some of the changes have been implemented, and their associated priorities, have not necessarily been accompanied by the substantial community engagement that would ensure diverse community members' voices are heard and their needs are prioritized (Hester 1990; Rosener 1979; Ryan 2012; Badger 2020). The notion of a 'Right to the City' (Harvey 2013) can be reinforced or suppressed in these acts of appropriation, and indeed, it is one theoretical position from which to evaluate and imagine urban space transformation. To appropriate urban landscapes for collective social and recreational interests is to express the group's interests and values in physical, performative ways (Douglas 2018; Foster 2020). With this lens, we can distinguish between among public space transformations that provide these spatial rights, such as those that are accessible and publicly supported, with those that are private and commercial, creating economic and other barriers for diverse populations (Storring 2020).

While the reservoir provides for this type of spatial appropriation, and indeed serves as an accessible site and a social leveler, it might also benefit from harnessing place attachment in support of broader maintenance and design objectives. Initial observations of human connection to the reservoir, as seen through the donation of folding chairs, the leather strap placed to damper a banging door, and the regular sweeping of the surface, suggests that there is already a certain level of place attachment, and that this could be expanded and extended in pursuit of bigger design features. Projects that might originate through DIY urbanism, or informal urbanism, can gain legitimacy to become a valued and accepted part of the collective urban space (Douglas 2014; 2018). In this sense, "the environment is not a passive "out there" condition, but something that everyone participates in creating and defining," (Gieseeking et al. 2014) a notion that underscores the transformative power of various improvisational public platforms that have risen out of the pandemic.

As a commercial venture, the makeover of Strong Avenue presents economic barriers to accessibility and thus may be critiqued as a form of exclusionary urban design that seeks to draw out upscale consumers while deterring use by the broader public. Privatization of public space is a fraught topic, and the need to support businesses that are suffering during the pandemic by activating public space on their behalf is merely the latest chapter (Storring 2020). Discussion of whether the public's interests can truly be advanced through private funding has been the subject of long-standing debate, particularly since the second half of the twentieth century when the pressures to turn over the funding and operation of publicly owned land to private interests began to be particularly intense (Thompson 2001). Such privatization may be accompanied by overt defensive architectural elements such as exclusionary signage (Knoblauch 2018), or more diffuse barriers to social inclusion, such as a normalization of behaviors that privileges some socio-economic groups over others (Storring 2020). By providing only private spaces for consumption, these types of leisure oriented third places risk replicating societal stratification rather than acting as social levelers (Yuen and Johnson 2017). Future adaptations that aspire to activate the more socially diverse dimensions of third spaces, will need to recognize the complexity and intersectionality associated with developing consumer oriented public spaces, and balance public inclusivity while supporting the local businesses that contribute to an economically viable and vibrant downtown.

6.0 CONCLUSION

These two case studies, thousands of miles apart, highlight the transformative capacity of otherwise mundane urban surfaces under pandemic conditions. Along with this latent potential comes a call to action, and the possibility of engaging citizens in the work of seeding positive change in their own cities. In periods of crisis, improvisational behavior can seed creative new acts, and these practices may be worth holding onto even after the crisis has passed. One of the main drawbacks of the urban design adaptations that emerged out of the pandemic is that they lacked a process to ensure equity. Future planning processes might then apply this lens to evaluate previous initiatives before accepting adaptations more permanently (Storring 2020).

The uptick in use of informal third places during the COVID-19 pandemic was born out of necessity rather than design. And yet, this spatial opportunism provides insight into people's interests, values and motivations. In the two sites studied, both human behavior and physical space were transformed to meet these needs. That people were willing to adjust and adapt to the pandemic in order to satisfy their third place needs during the pandemic demonstrates the resilience of public space to shift to accommodate new and changing urban activities, and it also highlights the kinds of activities that people prioritized during this time. In both places, social interaction appeared to be a central driver of spatial appropriation, and in both cases the physical makeup of the sites was flexible enough to support this improvisation.

Moreover, the kinds of interactions that these two sites supported appeared to have the characteristics of positive urban space for communities. It is possible that urban designers and planners will need to pivot in the future to support community groups experiencing quarantine conditions. It is also possible that people will revert to previous behavior, and established expectations governing the social use of public outdoor space. But perhaps there is a middle ground,

in which planners and stakeholders might envision a continuation of successful aspects of their pandemic spatial appropriation, in pursuit of a better quality of life even without the restrictions of the pandemic. Indeed, Lindsey McCunn notes that “new place dependencies have formed for some people during the pandemic and are understood to be satisfactory – and are perhaps even missed when social restrictions are eased” (McCunn 2020, 4).

REFERENCES

- Badger, Emily. 2020. “The Pandemic Has Pushed Aside City Planning Rules. But to Whose Benefit?” *The New York Times*, July 20, 2020, sec. The Upshot. <https://www.nytimes.com/2020/07/20/upshot/pandemic-city-planning-inequality.html>.
- Cutrara, Samantha. 2020. “Green Places and Third Spaces during and after COVID-19.” Text. *NiCHE* (blog). World. September 3, 2020. <https://niche-canada.org/2020/09/03/green-places-and-third-spaces-during-and-after-covid-19/>.
- Doctoroff, Daniel L. 2021. “Tear Down the Restaurant Sheds Before It’s Too Late.” *The New York Times*, July 22, 2021. <https://www.nytimes.com/2021/07/22/opinion/nyc-outdoor-dining-restaurant.html>.
- Douglas, Gordon. 2014. “Do-It-Yourself Urban Design: The Social Practice of Informal ‘Improvement’ Through Unauthorized Alteration.” *City & Community* 13 (1): 5–25.
- . 2018. *The Help-Yourself City: Legitimacy and Inequality in DIY Urbanism*. Oxford: Oxford University Press.
- Finlay, Jessica, Michael Esposito, Min Hee Kim, Iris Gomez-Lopez, and Philippa Clarke. 2019. “Closure of ‘Third Places’? Exploring Potential Consequences for Collective Health and Wellbeing.” *Health & Place* 60 (November): 102225. <https://doi.org/10.1016/j.healthplace.2019.102225>.
- Foster, Nicole. 2020. “Rethinking the Right to the City: DIY Urbanism and Postcapitalist Possibilities.” *Rethinking Marxism* 32 (3): 310–29.
- Gehl, Jan, and Birgitte Svarre. 2013. *How to Study Public Life*. Washington: Island Press.
- Gieseeking, Jen Jack, William Mangold, Cindi Katz, Setha Low, and Susan Saegert. 2014. *The People, Place, and Space Reader*. New York: Routledge. <https://peopleplacespace.org/toc/section-2/>.
- Harvey, David. 2013. *Rebel Cities: From the Right to the City to the Urban Revolution*. Paperback ed. London: Verso.
- Hester, Randolph T. 1990. *Community Design Primer*. Mendocino, CA: Ridge Times Press. https://www.worldcat.org/title/community-design-primer/oclc/21037798&referer=brief_results.
- Jeffres, Leo W., Cheryl C. Bracken, Guowei Jian, and Mary F. Casey. 2009. “The Impact of Third Places on Community Quality of Life.” *Applied Research in Quality of Life* 4 (4): 333. <https://doi.org/10.1007/s11482-009-9084-8>.
- Low, Setha. 2020. “Third Places Define Us. COVID-19 Threatens to Permanently Upend Them.” *Fast Company*. May 6, 2020. <https://www.fastcompany.com/90500609/third-places-define-us-covid-19-threatens-to-permanently-upend-them>.
- Low, Setha, and Mark Maguire. 2020. “Public Space during COVID-19.” *Social Anthropology* 28 (2): 309–10. <https://doi.org/10.1111/1469-8676.12885>.
- Low, Setha, and Alan Smart. 2020. “Thoughts about Public Space During Covid-19 Pandemic.” *City & Society* 32 (1). <https://doi.org/10.1111/ciso.12260>.
- Marcus, Clare Cooper, and Carolyn Francis, eds. 1998. *People Places: Design Guidelines for Urban Open Space*. 2nd ed. New York: Wiley.
- McCunn, Lindsay. 2020. “The Importance of Nature to City Living during the COVID-19 Pandemic: Considerations and Goals from Environmental Psychology.” *Cities & Health*. <https://doi.org/10.1080/23748834.2020.1795385>.
- Oldenburg, Ray. 1989. *The Great Good Place: Cafes, Coffee Shops, Community Centers, Beauty Parlors, General Stores, Bars, Hangouts and How They Get You Through the Day*. 1st ed. New York: Paragon House.
- Rosener, Judy B. 1979. “Matching Method to Purpose.” In *Citizen Participation in America*, edited by Stuart Langton, 109–22. Lexington, Mass: Lexington Books.
- Ross, Philip. 2021. “2021 Trend #4: Third Spaces and Localised Working.” *Unwork* (blog). February 11, 2021. <https://www.unwork.com/blog/2021-trend-4-third-spaces-and-localised-working/>.
- Ryan, Robert. 2012. “Site Design: Human Health and Well-Being.” In *The Sustainable Sites Handbook: A Complete Guide to the Principles, Strategies, and Best Practices for Sustainable Landscapes*, edited by Meg Calkins, 429–78. New York: Wiley.
- Storring, Nate. 2020. “Equitable Development During & After COVID-19: Five Takeaways.” Project for Public Spaces. June 12, 2020. <https://www.pps.org/article/equitable-development-during-and-after-covid-19-five-takeaways>.
- Thompson, J. William. 2001. “In Search of Public Space.” *Landscape Architecture* 8: 69–73, 88–91.
- Volpe, Allie. 2021. “Covid Ruined Our Hangout Spots. Here’s How They Come Back.” *Bloomberg.Com*, April 6, 2021. <https://www.bloomberg.com/news/articles/2021-04-06/the-death-and-post-covid-rebirth-of-third-places>.
- Whyte, William H. 1980. *The Social Life of Small Urban Spaces*. Washington, D.C.: The Conservation Foundation. <https://www.pps.org/product/the-social-life-of-small-urban-spaces>.
- Yuen, Felice, and Amanda J. Johnson. 2017. “Leisure Spaces, Community, and Third Places.” *Leisure Sciences* 39 (3): 295–303. <https://doi.org/10.1080/01490400.2016.1165638>.

Whose Heritage, Whose Investment, Whose Sustainability? Multi-actor Dynamics Around Green Space in Late-Modernist Residential Developments (Bordeaux, France)

J. Kent Fitzsimons¹, Fanny Gerbeaud¹

¹École nationale supérieure d'architecture et de paysage de Bordeaux, Laboratoire PAVE, France

ABSTRACT: This paper presents research into tensions between private and public land ownership in light of debates about heritage architecture and urban sustainability. The project studied challenges faced by owner-occupants of two residential developments built around 1970 in greater Bordeaux, that are regarded as distinguished examples of late modernist residential architecture: the Hameau de Noailles (Salier, Courtois, Lajus and Sadirac, 1968-1973) in Talence, consisting of 40 semi-detached patio houses and 140 apartment units sharing a pool, tennis courts and green space; and Pontet-Lamartine (Pierre Calmon, AUA 33, 1970-71) in Pessac, consisting of 32 terraced patio houses and 80 apartment units sharing a tennis court and green space. The French word "*patrimoine*" is polysemic, meaning both *heritage* and *estate* in the sense of capital. Our research shows that both individually and collectively through the homeowners' association, the residents of these mini-neighborhoods may be torn between the cultural value of their property and its value as a long term investment. Contemporary injunctions about sustainable maintenance and renovation aggravate tensions along this axis and amongst homeowners in the co-property structure. The challenge is to adapt these examples of late modernist architecture and urbanism to expectations regarding sustainable development and lifestyles while preserving their qualities as "*patrimoine*". After a summary presentation of the research corpus, methodology and results, the paper focuses on the articulation between each development's inherent urban qualities and the broader local community's needs and desires. An important issue faced in both cases was how the co-property's quality common outdoor spaces might contribute to the larger area's sustainability performance, in terms of ground permeability, biodiversity, soft mobility and usable green space. This results in tension between diverse actors including individual homeowners, the homeowner association, and municipal authorities. The paper will explore the shifting articulations between the case for architectural heritage, homeowner interests, and urban community life under pressure of sustainability injunctions.

KEYWORDS: Architectural heritage, Sustainability, Green space, Home ownership, Public space

INTRODUCTION

This paper presents research into the tensions between privately-owned land and its public uses in light of debates about architectural heritage and urban sustainability (Fitzsimons et al. 2019; Fitzsimons et al. 2021). It focuses on co-ownership residential ensembles whose outdoor space constitutes a potential resource for the broader community, as the surrounding neighborhoods densify and as the local climate increasingly reflects global warming. Such cases put into play different interpretations of what "heritage" means and to whom it belongs. They also break open the apparent homogeneity of the concept of sustainability by revealing different spatial and temporal scales and different interests at play in attempts to meet current human needs without compromising the natural substrate necessary to allow future generations to do the same (UN 1986: 16). Put simply, cases where private land may be a resource for the public good allow us to submit conventional ideas about architectural heritage to the scrutiny of another kind of heritage whose vitality has more recently come to the fore: a livable planet as a birthright, obliging us to protect it in the interest of those who will follow us (Caye 2020).

We first present the research project that provided material for the conclusions shared here. The paper then addresses the polysemy of the French word used to denote cultural heritage: *patrimoine*. Indeed, *patrimoine* is also a synonym for inheritance or estate, in the sense of capital. Its use in the context of residential architecture is therefore complex, as it evokes both the general cultural interest of past aesthetics, techniques or lifestyles as inscribed in a house or apartment (Heinich 2009), and the particular financial interest of its owner – who may also have "invested" his or her home with sentimental value. This polysemy becomes particularly resonant when confronting sustainability's necessarily collective dimension, in which the idea of equity is at stake. With this matter of vocabulary addressed, we describe the two residential ensembles chosen to illustrate the phenomenon, focusing on their respective urban dimensions. Finally, in the last section, we analyze how the proprietary open spaces that structure and embellish these

ensembles animate debates at the intersection of heritage/estate and sustainability. We compare and contrast the two cases in order to explore how green spaces crystallize tensions not only between private and public interests as represented respectively by homeowners and actual or potential non-resident users, but also amongst homeowners in the co-property structures themselves. This part highlights the temporal dimension that sustainability imposes on considerations about how environments we inherit from the past might correspond to the new modes of dwelling that we must adopt. In this way, our research bridges from the notion of heritage as either general cultural or private financial value, to heritage as a common resource – not to say “capital” – for adapting to the needs of an uncertain future.

1.0 THE RESEARCH PROJEC: SUBJECT, CORPUS, METHODOLOGY

The research from which this paper draws its results was carried out between 2016 and 2021 in the greater Bordeaux area (France). It was funded by France’s Ministry of Culture, through the 4-year research program *Twentieth-Century Architecture, Project Material for the Twenty-First-Century Sustainable City* (2016-2020). This program sought to develop theoretical and practical knowledge about how the heritage value of buildings and spaces built during the Twentieth Century might be fostered while also transforming them in light of the energy and ecological transition and changes in lifestyles. Our response to the call for proposals defined 1970 as a watershed moment after which the principles of modern architecture and urbanism that still held sway over development would unexpectedly be put into question. A nascent consciousness about the “Limits to Growth”, to cite the Club of Rome report of 1972, combined with geopolitical shocks starting with the 1973 oil crisis and spanning through that of 1979, troubled many assumptions underpinning such principles. These ranged from the architectural scale, such as full-width windows and spatial fluidity in plan and section, to the urban scale at which a rapidly expanding car culture drove functional segregation and decreased density. Based on a belief in the availability of unlimited energy and zero external costs for consuming it, much housing built around 1970 therefore corresponded to a future that would never be.

Fifty years later, such building stock has already been modified, whether through regular maintenance or through adaptations responding to changing standards for environmental performance. It faces even more pressure for modification today: newer, more strict regulations about energy consumption that enforce a rating system may encourage alterations in anticipation of property sales; and local development policies for densifying already urbanized land, notably in relation to public transit infrastructure (A’Urba 2011), threaten to alter the balance between built and unbuilt space that characterizes many noteworthy projects from the pre-1973 era. Yet in some cases, such ensembles have qualities that are not only emblematic of modernist architectural and urban design and therefore worthy of respect for historical reasons. They may also be assets when facing imminent challenges of the energy and climate transitions. Unfortunately, these qualities are often not recognized by piecemeal approaches to insulating, repartitioning or extending existing structures, or to adding buildings to an existing ensemble, leading to their being irremediably altered or even destroyed.

Our research sought to identify ways to reconcile the injunctions brought on by sustainability considerations with the goal of preserving remarkable aspects of residential architecture from the twilight of modernism (Fitzsimons et al. 2019). To do so, we composed a pluridisciplinary team to study four residential neighbourhoods built between the late 1960s and the early 1970s in the Greater Bordeaux area, and that may be regarded as distinguished examples of late modernist architecture (Coustet and Saboya 2005; Ragot 1996). This paper focuses on the two ensembles that associate small- and medium-sized apartment buildings with terraced or semi-detached houses: the Hameau de Noailles in Talence (Salier, Courtois, Lajus and Sadirac, 1968-1973), and Pontet Extension 4 in Pessac, in particular a component called Pontet-Lamartine (Pierre Calmon, AUA 33, 1970-71).

Our multi-disciplinary team employed a variety of methods for studying the two neighborhoods. An architectural and historical analysis placed the qualities of the original designs into a disciplinary perspective. On the side of fieldwork, a sociological survey used semi-directive interviews and collective workshops to garner perceptions and opinions from owner-occupants and other stakeholders such as renters and municipal authorities. Likewise, an environmental study (*ambiances*) undertook multi-criteria quantitative and qualitative analyses of performance and comfort in the houses and open air spaces. In both residential ensembles, the research method led to interactions almost exclusively with owners of houses. Indeed, apartment unit owners appeared to be less concerned about the problem of reconciling architectural heritage issues with adapting buildings and sites to increasingly strict environmental and ecological imperatives, perhaps because building maintenance and improvement is managed collectively; in contrast, house owners are individually responsible for their building envelopes, utility networks and heating and cooling systems. Another factor may be that, in both developments, renter-occupation is higher in the apartment buildings than in the houses. This apparent self-selection by participants has been taken into account in interpreting results.

The rest of this paper presents results drawn from this study. It focuses on how the prospect of adapting these projects “inherited” from the modernism’s swan song to today’s urgent sustainability imperatives raises debates amongst diverse stakeholders, in order to better understand actor dynamics around these socio-spatial issues.

2.0 WHOSE HERITAGE? “PATRIMOINE” BEYOND PUBLIC CULTURAL HERITAGE PRIVATE AND INVESTMENT

The French word “*patrimoine*” is polysemic, meaning both *heritage* and *estate*, in the sense of capital. Our research shows that both individually and collectively in the form of the homeowners’ association, the residents of these micro-neighborhoods may be torn between the cultural value of their property and its value as a long term investment. Contemporary injunctions about sustainable maintenance and renovation aggravate tensions along this axis and amongst homeowners in the co-property structure. The principle challenge is how to adapt these examples of late modernist architecture and urbanism to expectations regarding sustainable development and lifestyles while preserving their qualities as “*patrimoine*”.

This question raises different issues depending on the scale observed. At the scale of the house or apartment building, conjugating heritage in both the cultural and proprietary sense on the one hand, and sustainability on the other, activates tensions between a building’s visible characteristics, its comfort, economic aspects of both its everyday use and exceptional investments, as well as its ecological and environmental qualities. The perimeter for these matters is generally constrained to the circle of individual owners within the co-ownership association. However, at the scale of the block and its environs, a whole other set of issues arises. In both areas studied, the private open space in particular constitutes heritage whose potential value for adapting the urban environment to sustainable lifestyles transcends the sole interests of its owners. Such a perspective requires not only assuming the primary polysemy of *patrimoine* in its collective cultural and individual financial dimensions, but also working it further to conceptualize the material substrate – the “earth system” – as a heritage that necessarily reconfigures private and public interests.

3.0 TWO LATE MODERNIST RESIDENTIAL ENSEMBLES

3.1 Hameau de Noailles

The Hameau de Noailles is a closed neighborhood that would be called a gated community in North America. The combination of this relatively rare status in France with the Hameau’s geographical situation creates a particularly interesting case to study adapting existing co-properties for global sustainability. Designed by the reputable Bordeaux architecture firm Salier, Courtois, Lajus and Sadirac, the Hameau was built between 1968 and 1973 (Jacques and Neve 1995). It consists of 140 apartment units and 40 semi-detached houses carefully distributed on a lot measuring about nine acres, for an average density of about 20 units per acre. (Figure 1) The apartment buildings vary in height between three and five storeys; the houses are either one or two storeys tall. A one-story clubhouse and a series of rooms in the semi-basement of one of the apartment buildings provide space for collective functions. The site is carefully landscaped to find balance between the internal street system, commonly-owned green spaces, outdoor amenities consisting of two tennis courts and an open-air pool, and the houses’ private gardens (backyards).



Figure 1: Hameau de Noailles, Talence, France; Salier, Courtois, Lajus and Sadirac, architects, 1968-1973. Aerial photo. Source: Google Earth 2020.

The architecture of the buildings and houses may be characterized as modernism informed by critical regionalism (Ragot, 1994). It combines expanses of white walls, flat roofs, and abstracted fenestration with climate-sensitive framing of outdoor spaces, expressed wood structural members, and ergonomic details in the same darkly painted wood for entry gates and guardrails. There is perceptible inspiration from Californian case-study houses on the one hand, and traditional Japanese architecture on the other. (Figure 2)

The Hameau's nine-acre lot is in fact a large parcel spanning from east to west in the middle portion of a very large block. (Figure 3) The rest of the block to the north of the Hameau is occupied by some thirty single-family houses in a conventional subdivision configuration. The remainder to the south is part of the university campus, where a former monastery now housing the institution's presidency sits in a landscaped park. On its long west side, the super block is delimited by a main artery that separates it from a vineyard (part of the Chateau Haut-Brion); on its east side, a meandering local access street serves a mostly residential neighborhood of single-family houses that also includes an important local youth center with indoor and outdoor recreational facilities.



Figure 2: Hameau de Noailles. Architectural characteristics. Source: (Author 2020)

As the Hameau gives onto roads on both the east and the west sides of the super block, it would seem to be a good place to divide the latter in two, and thus facilitate circulation in the area. And indeed, from the outset, the Hameau's internal street system includes a main road that links east to west, although with two right-angle turns. As there were originally no obstacles to accessing this private street from the public roads, through traffic was in fact common, as was non-resident use of reserved parking spaces. When tolerance for these practices declined on the part of Hameau residents, the co-owners' association decided to install code-access gates at both ends. We will see that local collective memory about the possibility of through traffic still informs perceptions about the Hameau's relative integration into Talence's civic body.

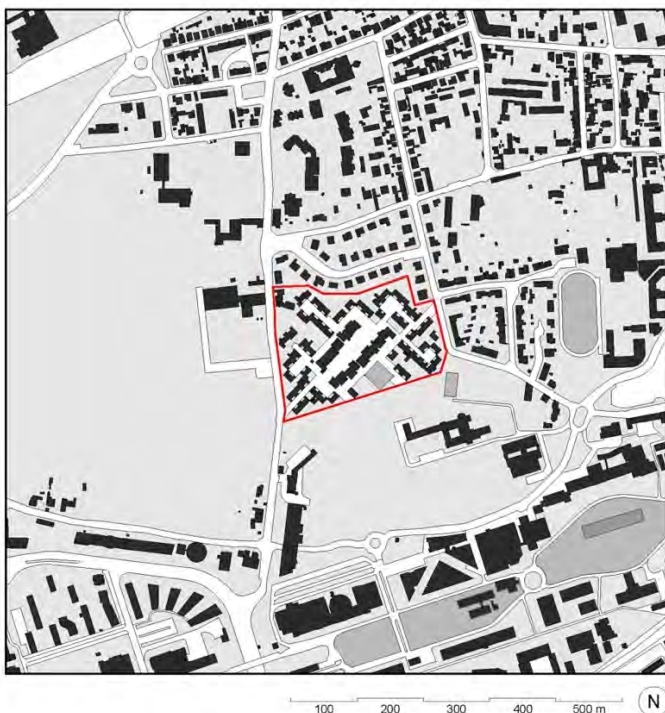

Figure 3: Hameau de Noailles. Situation plan. Source: (Author, 2017)

3.2 Pontet Extension IV

The second residential ensemble studied has the misleadingly less poetic name *Pontet Extension IV*. Situated in Pessac, it consists of one hundred twelve units of housing: eighty units in two apartment blocks of five and eleven storeys respectively, and thirty-two one-storey patio houses of which most are arranged as terraced housing and the rest as semi-detached houses. (Figure 4) For this project, developer Gilbert Saramite hired local architect Pierre Calmon (Callais, 2005). The ensemble was designed and built in 1970-71. Like the Hameau de Noailles, Pontet's overall property covers approximately nine acres, resulting in an average density of about twelve units per acre. Compared with the Hameau, Pontet's lower density translates as generous green space subdivided into a variety of atmospheres and amenities: two tennis courts, a planted garden, a children's play area, and a tree park. This latter element exists in great part because planned project's final piece was never built. The result is an impression of lush and generous green space for this co-property structure at the periphery of the Bordeaux agglomeration.



Figure 4: Pontet Extension IV, Pessac, France. Pierre Calmon, architect, 1970-71. Aerial view. Source: Google Earth, 2018.

Pontet's resolutely modernist architecture displays three variations. The ten-storey point block's pin-wheel plan expresses contrasts between full-width glazed bays in deep-set loggias at the extremity of each of the four "pins" and blind concrete walls along their sides. The five-story linear building adopts a stepped-back structure that provides large terraces for all apartments. Finally, the terraced and semi-detached houses differ from the apartment blocks, while maintaining a modernist language. (Figure 5) Their palette consists of white painted concrete walls and roof overhangs for the closed structures, bush-hammered raw concrete for the garden walls, and dark-painted wood doors and gates for forecourt and garage accesses. "Lanterns" rising above the ensemble's roofline mark each house's entry hall, thus achieving a sophisticated equilibrium between expressing the whole and expressing the parts.



Figure 5: Pontet-Lamartine. Architectural characteristics. Photo: (Author, 2020)

The architectural contrasts between Pontet's different housing typologies reflect the ensemble's complex co-property structure. One overarching co-owner's association regroups the house units, the two aforementioned apartment buildings, as well as another more recently constructed residential building. However, each of these four components forms a co-owners association of its own. In this nested management structure, the umbrella association takes care of the common open spaces and amenities, while each sub-association is responsible for its own building's maintenance. In the case of the grouped houses, while there is no collective structure, infrastructure or equipment *per se*, the co-owners association at this level allows in particular to define and enforce rules regarding the respect of certain architectural qualities. We will see that, overall, this specific co-property structure creates complexity for managing aspects that concern the overall site, in particular environmental subjects such as landscaping in both its technical and leisure dimensions.

At Pontet Extension 4, the quality open space at the center of the building complex is the private property of the co-owners. (Figure 6) However, it is not, and never was, enclosed by fences or gates. It is freely accessible, and seems like it is public. So while Pontet's development is one large block bordered by public roads, its heart seems naturally integrated into the continuity of public space. The main pedestrian path that traverses the block connects a broad sidewalk on the north side with a small intersection on the south side. This pedestrian path is dimensioned like a road; one has the impression of continuing on a public way, rather than crossing through private property. It leads to an intersection with a cul-de-sac public street that serves a dozen rowhouses and as many supplementary parking spaces. For a pedestrian, this cul-de-sac leads naturally to one end of the park space that, as we said, is private property. These few spatial cues that do not correspond to the usual devices used to delimit public and private outdoor spaces make the gardens, play area and park that sit on land belonging to the co-owners association feel like they belong to everyone.

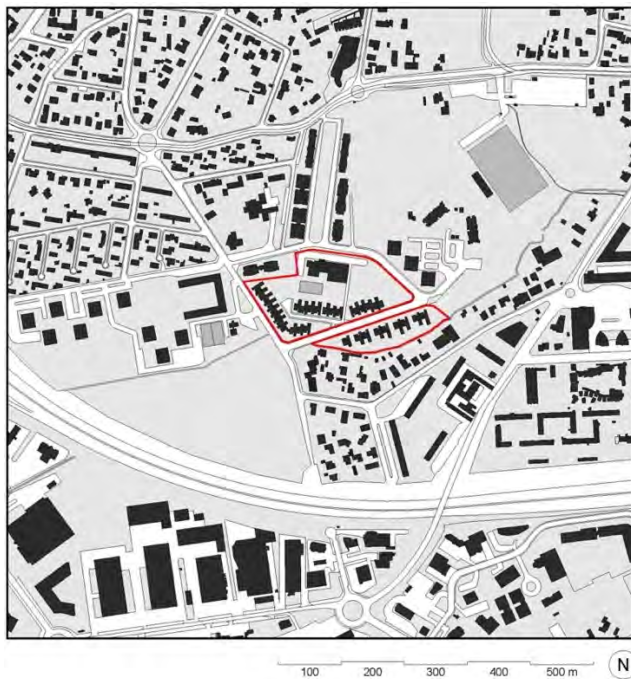

Figure 6: Pontet Extension IV. Situation plan. Source: (Author, 2017).

4.0 WHOSE INVESTMENT? SUSTAINABILITY FOR WHOM?

4.1 The Context of densification

Both the Hameau de Noailles and Pontet Extension 4 are in areas that today are being densified as part of the Bordeaux urban community's plan to combat sprawl with a more sustainable urban model. Local government policy particularly encourages modal shift from motor vehicle use to active modes such as walking and cycling, as well as public transit in the form of buses and especially light rail. Indeed, taking advantage of recent extensions of Bordeaux's new light rail system opened in 2003, the program "50 000 units of housing on transit lines" is building projects on available land served by tramways (A'Urba 2011). The Hameau and Pontet are on such axes. If, on the one hand, this benefits their residents, it also urbanizes formerly open space and ushers in local population growth. For example, just to the north of Pontet, the metropolitan development agency is building three hundred thirty new units for a density of about twenty units per acre; comparable to the Hameau de Noailles, this density is 60% more that of Pontet. In this context, the respective urban qualities of these two existing ensembles may appear to constitute an important resource for their immediate urban environment's new configuration. This perspective of course questions the status of their privately-owned open space. Before exploring the related tensions and opportunities at this scale, it is useful to outline already existing conditions within each development's resident community.

4.2 Internal affairs: Strains on co-ownership structures

If these neighborhoods are emblematic for their architecture, they are also instructive for the debates about heritage preservation raised by their regular management and adaptation to sustainability goals. Heritage and architectural matters elicit misunderstanding and even discord among stakeholders, and lead to thorough interrogations about energy-saving regulations, assessments and interventions. Drawing from existing studies on the topic (Brisepierre 2020; Roudil et al. 2009-2012), our study delves into specific challenges faced by architecturally remarkable sites. These point to conceiving sustainability around a variety of scales and actors, thus going beyond conventional approaches to address these issues.

It would be difficult to overstate the exceptional quality of the Hameau de Noailles as architectural and urban space. Indeed, the ensemble obtained the Ministry of Culture's "Remarkable Contemporary Architecture" label in 2015 (formerly "20th-Century Architecture"). Interest for this recognition varies amongst residents. Some of the original "pioneering" buyers still live in the Hameau, and their knowledge of the ensemble's history often casts them as guardians of aesthetic orthodoxy. While some recent arrivals purchased here specifically for the architectural character, other owners and many renters are less invested in this aspect. In the Hameau, tensions thus arise amongst co-owners regarding a variety of subjects, from deviations from aspects of the original architectural design during renovations (regulated in the co-property rules) to divergences about the use and maintenance of common areas. Our research shows that this is the case in particular at the intersection between the desire to preserve the architectural and urban design heritage of the Hameau and the desire to adapt the built environment to current needs and expectations, with projects such as house extensions, improving insulation for walls and windows, or installing energy equipment such as heat pumps and solar panels. Ensuing tensions are exacerbated by a heightened awareness amongst many residents about the community's unique history, and not only amongst the pioneers who purchased in the early 1970s.

In Pontet's umbrella co-owners association, there are clearly difficulties for managing and financing the maintenance of the property's generous open spaces. This is due as much to cost considerations as to built-in structural limits to its organization. In general, short term interests tend to pass the hurdle of approval by co-owners more easily than long term perspectives (Brisepierre 2014). At Pontet, for example, humidity problems on the land cause a general mosquito problem for the whole site (and presumably beyond); they also cause particular comfort and perennity nuisances for the houses located at the site's lowest point. Some house owners proposed that the umbrella co-owners association order a study that would link the humidity problems to a global diagnostic of the co-property's green spaces, in the hopes of identifying measures associating water management and a planting strategy that would be beneficial for all. Despite its very modest cost, the measure was never adopted, in large part because co-owners in the apartment buildings were unfavorable. Water poses another kind of problem: as there is no water counter for the co-property itself, fairly dividing costs for watering the green spaces amongst co-owners would be difficult. The chosen solution is to have a water tanker truck deliver water and bill the association. This choice is criticized by some residents, who favor solutions that would be more sustainable ecologically and socially: collect rain water, and employ local youth for occasional gardening and other green space maintenance. Observing these dynamics in the main association, some frustrated members comment that it is easier to vote cutting down trees than it is to plant or to water them; others water saplings planted in common spaces on their own utility bill.

4.3 External relations: Heritage as common resource

Despite such built-in obstacles, Pontet's global co-owners association has adopted a number of positive measures reflecting ecological awareness. The grass in open areas is left to grow as much as possible, in order to favor insects. Meadows are left fallow to encourage the growth of wildflowers. Recently, fruit trees were even planted on an unbuilt lot, much less to provide food for residents than to diversity plant and animal species in the area. Interestingly, this was also a tactic on the part of some co-owners to forestall a hypothetical sale of this lot to the metropolitan development agency, whose aforementioned densification projects might take interest in such a site.

Such ecological measures, which at first appear to be self-serving for Pontet co-owners, in fact also benefit the broader neighborhood. A form of generosity also exists at the more prosaic level of leisure space. Many house owners encountered consider that the co-property's accessible land should continue to provide green space for the public at large, and necessarily the residents of neighboring blocks. On this note, it is interesting that Pessac's planning department considers that the municipality's most remarkable heritage is its quality green space. It is indeed a relatively low-density environment: Pessac's overall density is one-quarter that of neighboring Talence, home to the Hameau de Noailles (although most of Pessac's territory in fact lies beyond the agglomeration's ring road). That this quality dominates official discourse while the city is particularly cautious about its numerous significant landmarks of modern architecture and urban design, not the least of which is Le Corbusier's Cité Frugès (1923-1929), speaks to how the climate change emergency is refocusing priorities. Regardless, Pessac is not interested in participating in managing Pontet's green space. The municipality is wary of giving the impression that co-properties might benefit from the advantages of private ownership while having negative aspects weigh on public responsibility. On the other hand, the City is considering funding projects carried by co-property residents, in the context of experimental measures using its participatory democracy budget.

Such a measure might only partially satisfy Pontet co-owners. Not only is managing the green space a complex logistical problem and at times a significant supplementary expense. In recent years, residents have noticed a distinct increase in inappropriate uses of their park, including drug dealing and suspected prostitution. A particularly disturbing event was when vandals lit a car on fire in the ensemble: parked on the street, the burning vehicle damaged the new external insulation of a recently renovated patio house. In the face of what is perceived to be increasing insecurity and incivilities, the co-owner association signed an agreement allowing the municipal police force to patrol the off street accessible areas that, as private property, are usually beyond its authority. But the hypothesis of fencing off Pontet's open spaces is voiced more and more frequently.

In echo to this situation, the Hameau de Noailles's main contribution to adapting the city to sustainable practices might be opening its access, if only partially. As mentioned, the internal street system was originally accessible to non-resident traffic, even though the property rights were unambiguously private. Some outsiders still criticize the Hameau for having become a "gated community", despite this having been its legal status from the start. Today, some residents owners of the Hameau wonder aloud whether it would be appropriate to allow unobstructed through traffic for walkers and cyclers by removing the pedestrian gates at both ends, while maintaining reserved resident access for automobiles. Located in the middle portion of a

very large block that separates some other residential blocks from a main artery, the Hameau de Noailles site could indeed provide a very useful shortcut for many users. Major bus line serves its east side, while its west side give access to nearby light rail station.

City officials are interested in this hypothesis; an added benefit would be exposure for the site's recognition as Remarkable Contemporary Architecture by the Ministry of Culture. This would be an interesting application of leniency regarding the public use of private property. In France, this kind of arrangement is foreseen in law. Legal dispositions provide for example that an alleyway in a dense urban environment that is co-owned by the buildings that line it, may be open for use by all in exchange for lighting and maintenance managed and financed by the public authority. Applying such a measure at the Hameau de Noailles would propel a project designed in an era when the personal motorized vehicle was the undisputed horizon for all of society into a future in which the responsible and collectively sanctioned choice is to limit individual car use to a bare minimum. And in doing so, it would question how the principle of private property may be subordinated to the interest of the common good, in the name of equity at a time when radical action is necessary in order to minimize climate change. Were this to transpire, the generally negative outside perspective on the Hameau's *entre-soi*, corresponding to a sentiment of either exclusion on the part of residents of neighboring streets or selfishness on the part of city officials, would likely evolve positively.

CONCLUSION

This paper aimed to delve into the socio-spatial dynamics at play in two residential co-property structures whose respective configurations could provide an interesting resource for meeting the need for lifestyles changes in their broader urban contexts. Research revealed that an important issue faced by the homeowner's association in both cases was how the co-property's quality common outdoor spaces might contribute to the larger area's sustainability performance, in terms of ground permeability, biodiversity, soft mobility and usable green space. This results in tension between diverse actors including individual homeowners, the homeowner association, and municipal authorities. Based on the two case studies, the paper explored the shifting articulations between the cause for architectural heritage, homeowner interests, and urban community life under pressure of sustainability injunctions.

In France, there is a precise term for the architectural intervention through which private land whose spatial characteristics lead to it being confused with public space is closed off from free access: "*résidentialisation*". It was done long ago at the Hameau de Noailles, when entry gates effectively put an end to through traffic. Today, a partial reversal of this measure may perhaps transpire. At the same time, the prospect of *résidentialisation* at Pontet is a real threat. It would remove a quality amenity from public access, at a moment when local densification will likely increase need for it. In both cases, it seems urgent to put stakeholders around the table, including the co-owners association, municipal authorities and reliable representatives of existing or potential external users, in order to identify alternatives to *résidentialisation*. Indeed, many post-war residential developments in France tested the same principles of spatial organization in which generous common open space mediates between the public street and the private court or garden, beyond the scale of what was common in the city inherited from the nineteenth century and earlier. Similar spatial questions about limits between public and private domains, and organizational questions about property management, security and expenses, arise in those situations. Lessons learned at the Hameau de Noailles and Pontet could inform measures in other cases where rethinking boundaries, shared use, maintenance costs and responsibilities is necessary for developing urban resilience.

Finally, we may also note the value of the Hameau and Pontet as examples for contemporary development. The Cities of Pessac and Talence expressed interest in our research because they perceive these ensembles as qualitative projects that are aging well. Taking into account lessons learned over fifty years of history, they could be models for future development that responds to the imperatives of global sustainability.

REFERENCES

- A'Urba. 2011. *5 dialogues pour 50000 logements autour des axes de transports collectifs : synthèse du dialogue compétitif*. Bordeaux: Communauté Urbaine de Bordeaux, 73p.
- Brisepierre, G. 2014. « Comment se décide une rénovation thermique en copropriété ? Un nouveau mode d'organisation de l'habitat comme condition de l'innovation énergétique », Flux n. 96, pp. 31-39.
- Brisepierre, G. 2020. *Le grand jeu social de la rénovation énergétique : un tour d'horizon des acteurs*, Leroy Merlin Source research report.
- Callais, C. 2005. « Trois variations pour vivre moderne : Pessac-Talence, 1965-1970 », in *Le Festin*, Bordeaux, n° 52, pp. 88-91.
- Caye, P. 2020. *Durer : Éléments pour la transformation du système productif*. Paris: Les Belles Lettres.
- Coustet, R. and Saboya, M. 2005. *Bordeaux, la conquête de la modernité : architecture et urbanisme à Bordeaux et dans l'agglomération de 1920 à 2003*. Bordeaux: Mollat, 402 p.
- Fitzsimons, K., Gerbeaud, F., Godier, P., Barlet, A. and Mazel, C. 2019. « *Redivivus : Les mouvements modernes rattrapés par la marche du durable. Leçons, adaptations et inventions des lieux du quotidien*. Bordeaux, France | Cincinnati, Etats-Unis ». Research report for the French Ministry of Culture, 258p.
- Fitzsimons, K., Gerbeaud, F., Godier, P., Barlet, A., Mazel, C., Labarchède, M. and Georges, A. 2021. « *Réaliser le potentiel REDIVIVUS des quartiers d'habitat moderne : expérimenter des méthodes d'accompagnement au carrefour du patrimoine et de la ville durable* ». Research report for the French Ministry of Culture, 95 p.
- Heinich, N. 2009. *La fabrique du patrimoine. De la cathédrale à la petite cuillère*. Paris: Maison des sciences de l'homme, 288 p.
- Jacques, M. and Neve, A. 1995. « Salier, Courtois, Lajus, Sadirac, Fouquet. Atelier d'architecture. Bordeaux 1950-1970 ». Bordeaux: arc en rêve centre d'architecture.
- Ragot, G. 1994. « Le Hameau de Noailles » in *Le moniteur d'architecture*, Paris, n°51, mai.
- Ragot, G. 1996. « Bordeaux et son agglomération, 1945-1995 ». *Guide d'architecture, Bordeaux*. Bordeaux: arc en rêve centre d'architecture / Centre régional des lettres Aquitaine / Confluences, 248p.
- Roudil, N., Flamand, A., Beillan, V. and Douzou, S. 2009-2012, *La consommation énergétique : de la résidence à la ville. Aspects sociaux, techniques et économiques*. Research report for the Agence nationale de la recherche.
- UN United Nations. 1987. *Report of the World Commission on Environment and Development: Our Common Future*. New York.

Walking Towards a Sustainable Future for Urban Design

Summer Stevens¹, Nawari Nawari¹, Michael Volk¹

¹University of Florida, Gainesville, FL

ABSTRACT: The walkability of urban environments plays a crucial role in sustainable urbanism. It can contribute positively to a city's economy, equitability, resiliency, sustainability, physical and mental health. To increase walkability levels within an urban environment, one must understand the factors that constitute walkability and their relationships. This research aims to answer how these key elements of walkability work synergistically to enhance urban living while adding to resiliency and sustainability. The study's objectives include using GIS along with data from walkability indices and federal land cover databases to evaluate the indicators of walkability and resiliency within three case studies. The case studies selected for this research are Boulder, Colorado; Portland, Oregon; and West Palm Beach, Florida. These cities have been chosen because they offer different strategies with great success in their approaches and efforts towards sustainability. The walkability phenomenon is observed in these cities focusing on street design and infrastructure, codes, and policies that reflect increased density, mixed uses, and affordable housing. The paper analyzes the walkability scores of these cities; then, it will compare the resilience or adaptability components in these urban environments. These two analyses will then be compared to approximate how resilient these cities are to climate change impacts like flooding and heat islands. The paper proposes adjustments to traditional walkability index frameworks which accommodate and stress the importance of increased resiliency. A statistical model is proposed to quantify these indicators to determine how they correlate within each city to achieve improved resiliency and, therefore, increased sustainability and walkability. This study indicates that better walkability can be committed through various strategies, each unique to a location's environmental, cultural, and political aspects, all while improving the resilience to climate change impacts. The proposed framework offers designers and planners additional research to contribute to the importance of walkability to a resilient, sustainable urban future.

KEYWORDS: Walkability, Resilient, Sustainable, Tree Canopy, Imperviousness

INTRODUCTION

In the past, natural systems have been able to adapt to changing climate patterns. Nature has the ability to clean the air and water, pollinate food, and control pests at their best. But as humans continue to stress these natural systems, they become less efficient at providing these benefits. This, in turn, causes man-made infrastructure to be less resilient with less ability to adapt and recover to extreme events. Although climate change cannot be solved by policy-making and market incentives alone, it can help guide businesses and residents on a path to follow.

1.0 Advantages of Walkable Place Design

A sustainable future for urban development is possible through an interdisciplinary approach. Walkability is at the root of sustainable urban development. Walkability is commonly referred to alongside livability and is often achieved through principles of smart growth and other complicated sub-factors that make a locale more or less walkable. The walkability of a neighborhood can be described by its environmental features, including the safety or traversability of an area. Walkability can also be described by outcomes fostered by these environments, such as increased exercise and the liveliness of an area. It can also be used as a term for holistic improvements to a multidimensional problem that can be measured and examined (Forsyth, 2015). For this paper, the definition of walkability will be referred to as the quantitative and qualitative measurement of how equitably, environmentally, and economically sustainable an environment is through key indicators of density, land use mix, connectivity, accessibility, and critical green infrastructure. Walkable environments encourage people to choose to walk or other forms of transit instead of being left with no alternative but to drive. Pedestrians will be drawn to walk based on their level of perceived safety, the condition of walking paths, the access to additional transit options nearby, and if there is a mix of uses to walk to. Walking is often associated with increased physical health as well as mental health. Accessibility is a key determinant of walkability. Accessibility is achieved through pedestrian-scale development, which is an infrastructure designed around people instead of cars. This leaves more room for complete streets and inviting streetscapes lined with cafes and vibrant, exciting places to gather. Increased density and connectivity allow for better access to these amenities which are located closer to each other in a dynamic mix, and routes are more easily changed or traversed to and from these uses. The increased density also enhances housing availability and affordability through a housing stock increase in urban centers instead of encouraging additional development along suburban fringes which adds to the issue of urban sprawl.

1.1 Importance of Adaptability

Walkability can often be accomplished through revitalization or adaptive reuse of blighted areas. These dilapidated or poorly used developments can become vibrant walkable and sustainable areas. By keeping development away from the suburbs, invaluable natural systems that still remain can be preserved. Improved water supply, increased biodiversity, and environmental justice is among the additional benefits of walkability. Through new technologies and passive or integrative design strategies, green infrastructure can be incorporated within already dense city centers to increase resiliency and sustainability. This can aid in reduced heat island effects and flooding caused by climate change. Microclimates within these urban areas can be enhanced by means of green walls, shade trees, rainwater storage, stormwater filtration and reuse, permeable ground cover, reclaimed water, and renewable energies. When people choose to walk to their destinations or to use alternative sustainable transportation options, the levels of emissions and particles which contribute to greenhouse gasses are proven to be reduced.

1.2 Patterns in Policy

Even though advocates and researchers have proven the innumerable sustainable merits of walkability and innovative growth development, pedestrian-centered design is still overlooked in many places. Transportation planners continue to focus mainly on car-centric design strategies, even if the focus is now on electric vehicles. As climate change and sustainability become increasingly accepted and further incorporated into government plans and strategies, especially internationally, more walkable places will begin to emerge as ideal factors combine. The arguments demonstrating the correlation between walkability and economic growth, public health, and environmental conservation can not be ignored. High levels of walkability can be seen in large cities and in small towns where they continue to enhance or slightly adapt their built environment. Yet North America, especially the United States, faces even more struggles due to previous poor development choices and the level of sprawl that exists today. Previous Euclidean zoning methods divided areas into specific zones where land uses were assigned or forbidden. This is now most often used to separate industrial uses and contamination threats but has been associated with increased segregation, limited housing supply stock, and suburban sprawl, which creates neighborhoods that encroach on natural resources and are solely dependent on cars (Watsky, 2018). States began embracing smart growth development principles, new urbanism, and the implementation of comprehensive plans after almost 90 years of Euclidean zoning methods (Watsky, 2018). Smart growth and New Urbanism focus on mixed uses, increased housing options, and affordability. Comprehensive plans can assist in walkability by guiding growth and planning for the future. Many towns are switching to form-based codes. The Strong Towns organization refers to codes as the DNA of a community and describes North American cities' DNA as broken. The Form-Based Codes Institute by Smart Growth America defines form-based codes as "land development regulation that fosters predictable built results and a high-quality public realm by using the physical form, rather than separation of uses, as the organizing principle for the code." Form-based codes address the relationship between building facades and the public realm, the form and mass of buildings in relation to one another, and the scale and types of streets and blocks, according to Smart Growth America. Parking reform is another argument often made by researchers. The adjustment - or altogether elimination - of mandatory parking minimums adopted in cities like Hartford, Connecticut, can be an example for other cities to review outdated codes that encourage car use (Herriges, 2020). Form-based codes can require increased greenspaces and tree counts and revitalize blighted neighborhoods or historic districts into new use.

1.3 Statement of Purpose

The purpose of this research project is to quantify the indicators of walkability within Portland, Boulder, and West Palm Beach to better understand the synergy of factors most successful in these areas. Resilient walkable cities are the key to sustainable futures for subsequent generations. It is essential to understand the key indicators of walkability in order to improve resiliency, maximize conservation of natural resources, encourage economic growth, revitalize towns, and improve physical and mental health. Also, the study seeks to quantify the resilience factors within these cities and examine their levels of adaptability to climate change. These two analyses will then be compared in each case study to identify key sustainable development strategies.

1.4 Objectives

The research objectives are organized into three sections. The first section examines the importance of sustainability through walkability through the compilation of key elements from scholarly journals. The second section examines the correlations between the factors within each case study to compare and draw parallels using an existing walkability index. Facilitators or barriers to walkability will be observed. The final section examines each case study's resilience or adaptability factors to compare with the existing walkability scores.

2.0 LITERATURE REVIEW

2.1 Definition of Walkability

It has been challenging to find an exact definition of walkability as they all differ slightly, and some factors of walkability cannot be accurately quantified. Forsyth well debated the definition of walkability in 2015 as she compared the most prominent definitions in her article "What is a Walkable Place? The Walkability Debate in Urban Design". Forsyth argues

that each definition creates a different result. Forsyth explains how some walkability metrics can be quantified while others are described as holistic approaches to good design. Forsyth elaborates on the environmental features which make areas walkable. They are traversable, compact, physically enticing, and safe. The outcomes fostered from these environments include increased exercise, liveliness, and enhanced sustainable transit. Walkability is often used as a proxy to describe better design whether measurable dimensions or holistically. Lastly, Forsyth explains how one multidimensional definition of walkability allows for its means to be measurable, which in turn creates indicators of the conditions of walkability. This definition is often related to livability and sustainable development. These measures can be measured individually or combined into an index (Forsyth, 2015). Walkability is a proxy for better environments that generate investment and are more sustainable economically, (Forsyth, 2015). Ewing & Cervero's 2010 Travel and the Built Environment study describes the facilitators of walkability. Planning and Urban design have been used to help reduce automobile use and its related social and environmental costs (Cervero, 2010). Sprawl, congestion, oil dependence, and climate change are reasons why local authorities are turning to planners and designers to shift away from automobile use (Cervero, 2010). Cervero's studies concluded that vehicle miles traveled (VMT) is most strongly related to measures of accessibility to destinations, secondarily to street network design variables. Walking is most strongly related to estimates of land use diversity, intersection density, and the number of destinations within walking distance. (Cervero, 2010). Cervero suggests this information is helpful for plans ranging from climate action plans to health impact assessments (Cervero, 2010).

2.3 Walkability Indices

Numerous walkability indices attempt to measure walkability through indicators that increase an environment's walkability. Indices vary on the number of factors they include and weigh those factors differently. Some can be used internationally while others are only applicable for a localized scale. This depends on the data and statistics available combined with the methodology of collection or surveying. The most major indices in academic literature were examined and compared to find the most suitable index for the case studies of Portland, Boulder, and West Palm Beach. The National Walkability Index (NWI) was chosen for this project based on the availability of its nationwide geographic dataset and the use of the most commonly cited factors in walkability research. The NWI ranks Census 2019 block groups according to their relative walkability (EPA.gov). The NWI is intended to help address a growing demand for data products and tools that enable users to consistently compare multiple places based on their suitability for walking as a means of travel. The NWI includes walkability scores for all block groups as well as the scores of the underlying attributes used to rank these block groups. These are found in the Smart Location Database, which summarizes more than 90 other indicators related to the built environment and location efficiency (EPA.gov).

2.4 Vulnerability & Resiliency

First Street Foundation nonprofit released a nationwide community-level flood resilience report in 2020 called "The 3rd National Risk Assessment: Infrastructure on the Brink". It describes the flood risks for every city and county within the United States. It calculates the flood risk by dimensions of community risk. This includes residential properties, roads, commercial properties, critical infrastructure, and social infrastructure. They have determined that, "Roughly 25%, or 1 in 4 of all critical infrastructure in the country are at risk of becoming inoperable today, which represents roughly 36,000 facilities. The highest concentration of community risk exists in Louisiana, Florida, Kentucky, and West Virginia, with 17 of the top 20 most at-risk counties in the U.S. (85%) residing in these 4 states" (firststreet.org, n.d.) The First Street Foundation Flood Model shows the probability of flood due to high rainfall, overflowing rivers, high tides, and coastal storm surge separately and then together (Flood Factor). It also provides FEMA flood zone information for properties as well. High-intensity rainfall causes flooding when sewage and drainage systems reach the capacity to drain the amount of rain, especially common in urban areas with little green infrastructure available to store water naturally. Flooding occurs in rivers or streams when increased water volume spills into adjacent floodplains often seen in flash floods where heavy rainfall causes rapid surges. This type of flooding is seen in Boulder, CO. Floods are also seen multiple times of the year during tidal flooding or king tide flooding. This type of flood occurs in low-lying coastal areas like South Florida. Storm surges are also seen in South Florida when stormwater rises above water levels, and increased rain worsens high water levels, often traveling inland.

2.5 Impervious Surfaces

According to an article in the Scientific Journal, the average global urban tree canopy cover has a slight but significant decline from 2012-2017 of about 40,000 ha per year, (Nowak & Greenfield, 2020). Nowak & Greenfield claim that all continents exhibited a loss in urban tree cover except for Europe. Along with the tree loss was an increase in impervious cover on all continents of about 326,000 ha per year (Nowak & Greenfield, 2020). Urban tree systems contribute to stormwater nutrient and volume control, according to a project by Moore and the Water Research Foundation that evaluated the effectiveness at different scales in order to integrate urban tree systems within stormwater and regulatory frameworks (Moore, 2021). Stormwater runoff is a massive contributor to polluted waterways. Rainwater washes over impervious surfaces while it collects pollutants and increases in speed. Preserved open spaces and increased density in developed areas help reduce stormwater runoff (US EPA, 2014). More dense developments consume less land and create less runoff yet supply the same number of housing units allowing for more previous cover to remain within the location's watershed, (US EPA, 2014). It is important to also incorporate sufficient open spaces and preserve critical ecological buffer areas to minimize additional land disturbances (US EPA, 2014). A 'Micro-level Urban-ecosystem

Sustainability Index (MUSIX), created by Dizdaroglu & Yigitcanlar, monitors aspects of urban ecosystems which include hydrology, ecology, pollution, location, design, and efficiency based on parcel-level indicators show that major environmental problems are caused by increased impervious surfaces from growing urban development, (Dizdaroglu & Yigitcanlar, 2016). Their findings suggest that impervious surfaces are linked to an increase in runoff, increased car dependency, transportation related pollution, poor public transit access, and an unsustainable built environment, (Dizdaroglu & Yigitcanlar, 2016). In a study, Jacob & Lopez questioned whether reduced land consumed by higher density development vs standard suburban developments would offset the worse water quality generated by a greater amount of impervious surfaces in the smaller area. The study showed that per capita loadings and runoff decreased with density and that higher densities similar to transit-oriented development could perform better than most traditional stormwater best management practices, (Jacob & Lopez, 2009).

2.6 Canopy Cover

“The global climate is projected to continue to change – how much depends primarily on the amount of heat-trapping gases emitted globally”(National Climate Assessment, n.d.). Trees provide oxygen and absorb carbon dioxide. By sequestering carbon dioxide, air pollutants are removed. “There are an estimated 5.5 billion trees in urban areas nationally, quietly providing \$18.3 billion in value to their communities. The challenge is to get the public to understand the value of these “free” public services, and the essential role the urban forest plays in the livability of their community”, (Plan-it Geo, 2021). Trees play a vital role in a thriving environment for all their inhabitants. Trees improve an area’s aesthetic and acoustics, provide biodiversity, and assist in physical and mental health (WHO, 2016). “Tree canopy cover specifically is the layer of tree leaves, needles, branches, and stems that provide tree coverage of the ground, viewed and mapped from an aerial perspective” (MRLC, 2021). Outdoor shade is a primary comfort indicator (Shammas & Escobar, 2019). Trees and vegetation help cool the environment and surface air temperatures. They do so by providing shade and through evapotranspiration (US EPA, 2014). This can assist in reducing peak surface temperatures as well as peak summer temperatures when combined. Trees and vegetation can be used as a mitigation strategy when planted strategically. They can cool buildings when placed on certain sides, parking lots, and streets. This in turn reduces energy usage and costs. This reduced energy usage cuts down on the greenhouse gas emissions and air pollutants produced by the built environment. Additionally, trees and vegetation can reduce runoff and erosion while also improving the water quality by filtering the rainwater after it is stored. The benefits of urban forests are always much higher than the costs of maintenance and planting. Ecosystem services provided by Trees and Vegetation are innumerable. “WHO’s rule of thumb is that urban residents should be able to access at least 0.5 ha within 1000 ft. from where they live” ((Green City Index, n.d.). The canopy size of a city determines its heat island reduction potential (Climate Central, 2021). Urban heat islands are metropolitan areas that have higher temperatures than the outer regions. These impacts are most often felt in the summertime (Climate Central, 2021). In highly developed areas, temperatures can rise 15 or 20 degrees higher than nearby areas that are more vegetated, shaded, or pervious. Heat islands are created chiefly by albedo, which means how much a surface absorbs heat or reflects sunlight (Climate Central, 2021). Impervious surfaces like parking lots, buildings and roads add to higher temperatures. Engines and air conditioners also add heat while increasing air pollution. The addition of trees on paved streets, green roofs, cool roofs, cool pavements, differing building heights, and smart growth can all relieve heat island impacts.

3.0 METHODOLOGY

3.1. Organization

The first section of this paper examines the importance of sustainability through walkability. Facilitators and barriers to walkability are observed. A compilation of key indicators within standard walkability indices is created and scrutinized. Further research is explored to determine a suitable existing walkability index for the case studies of downtown Portland, Boulder, and West Palm Beach. Oftentimes quantifiable measurements are used to measure intangible and overlapping qualities which make measuring walkability difficult. Each city is then ranked based on its walkability scores. There is not a single metric, only commonalities since people and places are all unique. The second section investigates the resiliency and vulnerability components of sustainable urban environments. These are often missing from existing walkability indices yet are paramount to the success of walkable urban environments. The third section surveys the correlations between the walkability and resiliency factors within each case study to compare and draw parallels. Changes in the cities ranks may or may not be observed once resiliency components are added.

3.2 Data Access

The walkability data research consists of GIS data from the National Walkability Index. The resiliency data research consists of GIS data from the National Land Cover Dataset which was last updated in 2019. The NLCD is created by the Multi-Resolution Land Characteristics Consortium, which consists of partnered federal agencies.

3.3 Walkability Subfactors

The NWI was chosen as the index for this case study because it applies to all census block groups within the United States. The NWI Index is supported by research from Erwing and Cervero following their 2010 metadata study, *Travel and the Built Environment*, funded by the EPA. The NWI includes intersection density, proximity to transit stops, employment mix, and employment and household mix (SLD, 2021). The magnitude of impact of these variables on

whether one chooses to walk was all powerful and comparable in the Erwing and Cervero study. For simplicity purposes, the index categories were each weighted 1/3, except for the land use mix category, which was given 1/6 each in order to combine two different methods of variable measurement. Every census block group received a ranked score for each of the four variables. These variable scores were used in the formula to produce their relative value which were then scored between 1-20 based on their position. The formula for the NWI is $(w/3)+(x/3)+(y/6)+(z/6)$, where w is the block group's ranked score for intersection density, x is the ranked score for proximity to transit stops, y is the ranked score for employment mix, and z is the ranked score for employment and household mix, (SLD, 2021).

3.4 Resiliency Subfactors

Climate change makes it essential to incorporate data showing resiliency efforts and monitoring through green space and infrastructure. Climate change vulnerability includes increased flood risks, higher temperatures, more intense/frequent storms, wildfires, and earthquakes. The resiliency analysis consists of examining the total tree canopy cover and impervious surface percentages in each of the case study downtown areas. The NLCD was chosen as part of this analysis due to its current, comprehensive, and available land cover dataset. Monitoring the up-to-date status of tree canopy cover and vegetation allows planners to focus on community-wide distributed protection and restoration projects. The GIS NLCD Tree Canopy Layer is available for the year 2016 which was released in 2019 (MRLC, 2021). This geospatial dataset includes all of the United States. Land cover change data has had a growing demand in research. The data consists of estimates of the percentage of tree canopy across all land cover types generated by the United States Forest Service from land sat imagery and ground information (MRLC, 2021). The percent tree canopy cover or TCC is the layer of tree coverage provided by its leaves, branches, or stems from an aerial view. The tree canopy cover is valued from 0 to 100 per 30m cell (MRLC, 2021). There are different levels of imperviousness. The GIS NLCD Impervious Surfaces layer includes data from 2001 to 2016 and was published in 2019 (MRLC, 2021). The layer represents urban impervious surfaces as a percentage of developed surface per 30m cell. This layer uses data from the National Geospatial Data Asset as well as U.S. Geological Survey.

4.0 CASE STUDIES ANALYSIS

4.1 Portland, Oregon

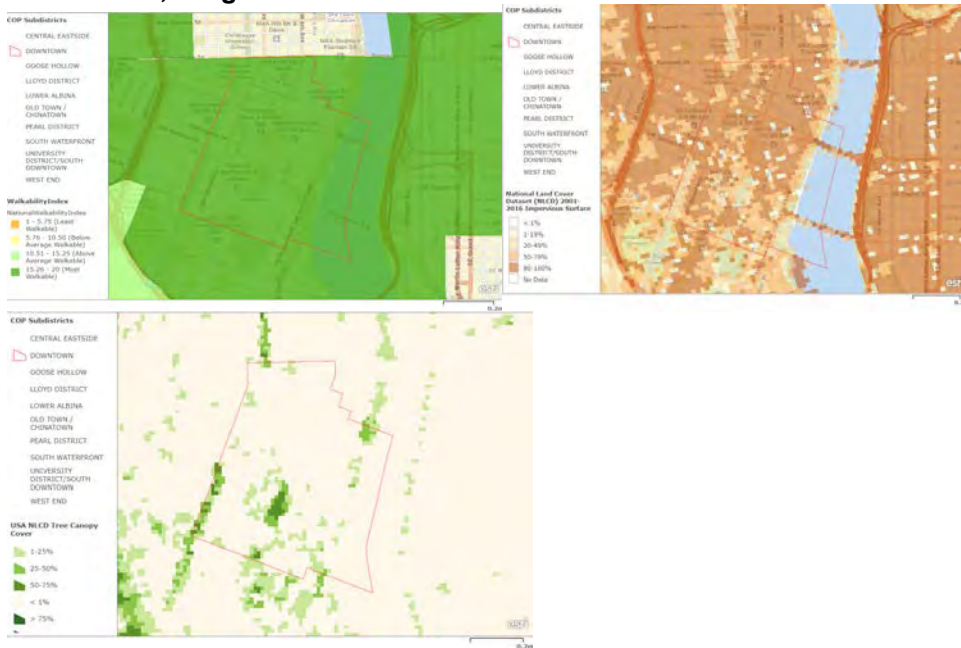

Figure 1: The National Walkability Index ranking of downtown Portland, Oregon.

Figure 2: The National Land Cover Dataset 2016 Impervious Surface of downtown Portland, Oregon.

Figure 3: The National Land Cover Dataset for Tree Canopy Cover of downtown Portland, Oregon.



Figure 4: The histogram above describes the National Walkability Index rankings within the block groups included in the downtown Portland, Oregon boundary.

Figure 5: The distribution of percent impervious surface per acre of downtown Portland, Oregon.

The walkability of downtown Portland, Oregon, and its surrounding area is very high. In Figure 1 above, all of the area within the red downtown boundary lines is shaded dark green, which signifies that it is 'Most Walkable'. In Figure 4, the histogram of the NWI shows that most of the area scores within the 18- 19 range. In Figure 2, the imperviousness of downtown Portland can be seen to be mostly shaded with dark orange. This reflects 80-100% imperviousness with a median of 85%. In Figure 5, the histogram of the percent imperviousness also shows that most of the area lies within the 70-100% range. Figure 3 reflects that the tree canopy cover is minimal. There is one dark green patch of tree canopy, which is most likely a park and green space. While walkability scores very high in Portland, imperviousness and tree canopy cover rank poorly. This is most likely due to increased density and a lack of prior planning to preserve open space. Impervious surfaces are important because they add to an area's natural resilience against floods of different types. These surfaces allow for water to pass through and be held in the soil or roots of trees instead of flowing over pavement as it picks up trash and pollutants before it drains out into the ocean or other large water bodies. This moisture in the soil improves temperatures in microclimates and often returns into the watershed or aquifer. Green spaces also provide mental and physical benefits for those passing through or enjoying them. Without adequate impervious surface area, heat from the sun becomes absorbed and radiates, which increases an area's temperature and adds to air pollutants through stagnation.

4.2 West Palm Beach, Florida

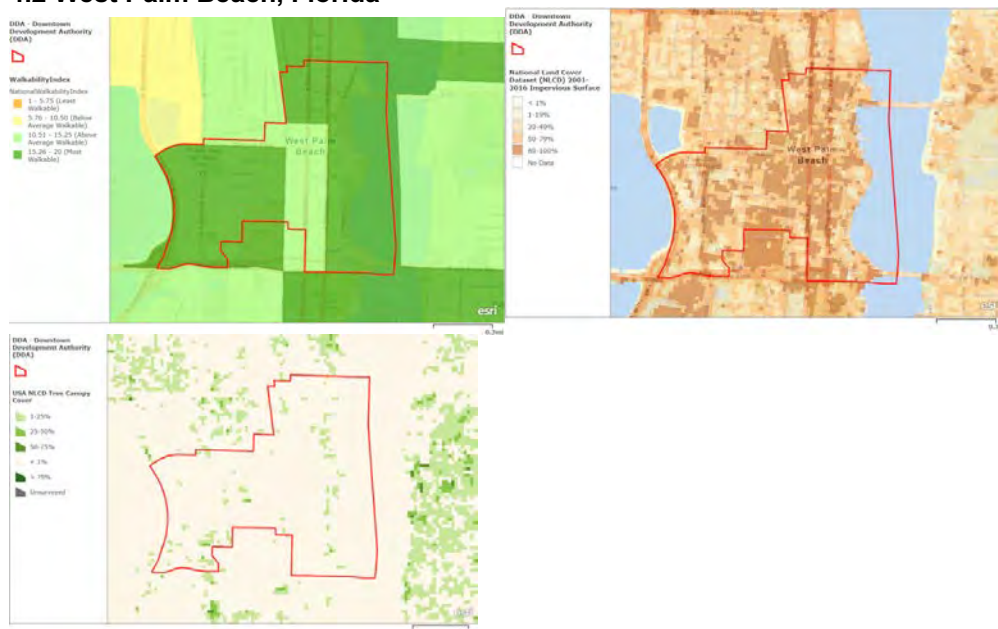

Figure 6: The NWI ranking of downtown West Palm Beach, Florida.

Figure 7: The NLCD 2016 Impervious Surface of downtown West Palm Beach, Florida.

Figure 8: The NLCD 2016 Tree Canopy Cover of downtown West Palm Beach, Florida.

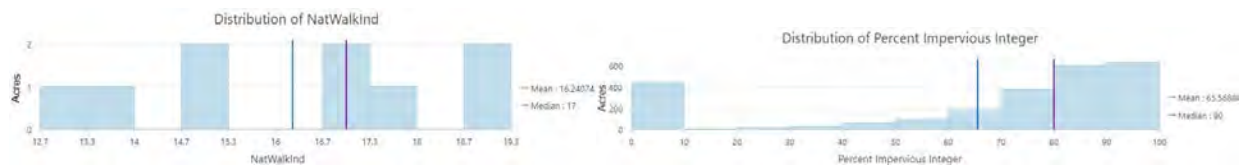

Figure 9: The histogram above describes the National Walkability Index rankings within the block groups included in the downtown West Palm Beach, Florida boundary.

Figure 10: The distribution of percent impervious surface per acre of downtown West Palm Beach, Florida.

Most of downtown West Palm Beach is ranked in the 'Most Walkable' category, as shown in Figure 6. One stretch of roadway with a lower rating; can be seen in light green shading, which signifies that it is just 'Above Average Walkable'. This is most likely due to low pedestrian friendliness and a higher speed limit. The histogram in Figure 9 shows that scores within the downtown WPB boundary range from 12.7 to 19.3. In Figure 7, the imperviousness of downtown West Palm Beach as a mix of darker and lighter orange shading signifies a more extensive range of percentages. In Figure 5, the histogram of the percent imperviousness also shows that most of the area lies within the 70-100% range and has a median of 80% imperviousness. Figure 8 reflects that the tree canopy cover is also minimal. A linear pattern can be seen along one stretch of Flagler Dr., which borders the Intracoastal Waterway. While walkability scores well in West Palm Beach, imperviousness and tree canopy cover rank poorly.

4.3 Boulder, Colorado



Figure 11: The NWI ranking of downtown Boulder, Colorado.

Figure 12: The NLCD 2016 Impervious Surface of downtown Boulder, Colorado.

Figure 13: The NLCD 2016 Tree Canopy Cover of downtown Boulder, Colorado.



Figure 14: The histogram above describes the National Walkability Index rankings within the block groups included in the downtown Boulder, Colorado boundary.

Figure 15: The distribution of percent impervious surface per acre of downtown West Palm Beach, Florida.

Downtown Boulder, Colorado, is also very walkable. The whole downtown area lies within the 'Most Walkable' dark green shaded area, as shown in Figure 11. The histogram in Figure 14 depicts that the NWI ranking within the area ranges from 17.3 to 19 on the scale, with a median of 18.5. In Figure 12, the imperviousness of downtown Boulder can be seen to be primarily dark orange shading. In Figure 15, the histogram of the percent imperviousness also shows that most of the area lies within the 60-100% range and has a median of 83% imperviousness. Figure 13 reflects that the tree canopy cover appears nonexistent within the downtown boundary yet abundant in the surrounding areas. In contrast, walkability scores well in Boulder, imperviousness and tree canopy cover rank poorly. This may cause increased stormwater runoff and make flooding hard to manage.

CONCLUSION

In conclusion, the walkability of urban environments plays a crucial role in sustainable urbanism. This careful design of the built environment embraces green infrastructure and improves the quality of life for its residents. Cities designed for cars, urban sprawl, and prehistoric zoning requirements have negatively impacted precious pervious surfaces and tree canopy cover across the United States. Increased awareness of environmental issues such as climate change and its subsequent impacts have encouraged planners and designers to focus more on resiliency and adaptability within the built environment. The variables which indicate high walkability in each of these case studies combined to create high scores. Although the walkability scores of these cities were each high and comparable, the resiliency and adaptability components within these environments were not impressive. The median walkability scores of the cities studied were 17-19. West Palm Beach has a slightly lower level of impervious surface percentage but ranked poorly in tree canopy coverage. Portland and Boulder are much the same. Boulder did well to preserve surrounding green spaces

while the downtown canopy remained almost nonexistent. Each of the case studies has a median score ranging from 80-85 percent imperviousness according to the NLCD.

While each of these cities is very different in terms of population growth, economy, design, natural environment, and climate, they all have one thing in common. They are all actively pursuing new sustainability strategies and technologies to fight climate change and aggressively increase resiliency for future generations. West Palm Beach faces specific challenges due to its low-lying coastal nature. These include saltwater intrusion, tidal flooding, storm surges, extreme weather events, and a rapidly growing population on top of it. Boulder also faces unique challenges due to its location and climate, including wildfires, high winds, and flash floods, while Portland faces many of the same challenges as Boulder, with added risks of earthquakes and volcanic eruptions. Increased density in already built environments and filling in these areas or redeveloping to expand the green infrastructure within downtowns adds to the creation of livable places. Tree canopy cover supplies comfort through shade and evapotranspiration in microclimates. Pervious surfaces aid in a community's resilience against flooding and water pollution. Stormwater management is improved by both factors. Walkable places that benefit its users' mental and physical health would not be possible without the inclusion of these two factors.

REFERENCES

- Ewing, R., and Cervero, R. 2010. *Travel and the Built Environment*. Journal of the American Planning Association 76 (3): 265–94. <https://doi.org/10.1080/01944361003766766>.
- Dizdaroglu, D., Yigitcanlar, T. 2016. *Integrating Urban Ecosystem Sustainability Assessment into Policy-Making: Insights from the Gold Coast City*. Gold Coast City: Journal of Environmental Planning and Management 59 (11): 1982–2006. <https://doi.org/10.1080/09640568.2015.1103211>.
- Forsyth, A. 2015. *What Is a Walkable Place? The Walkability Debate in Urban Design*. Cambridge, MA: URBAN DESIGN International 20 (December). <https://doi.org/10.1057/udi.2015.22>.
- Jacob, J., and Lopez, R. 2009. *Is Denser Greener? An Evaluation of Higher Density Development as an Urban Stormwater-Quality Best Management Practice*. Middleburg, United Kingdom: Journal of the American Water Resources Association 45 (3): 687–701.
- Moore, T. 2021. *Urban Trees and Stormwater Management: Quantifying Impacts, Maximizing Benefits*. Kansas: Us Forest Service Research and Development.
- Nowak, D., and Greenfield, E. 2020. *The Increase of Impervious Cover and Decrease of Tree Cover within Urban Areas Globally (2012–2017)*. Syracuse, New York: Urban Forestry & Urban Greening 49 (126638). <https://doi.org/10.1016/j.ufug.2020.126638>.
- Shammas, A., and Escobar, F. 2019. *Comfort and Time-Based Walkability Index Design: A GIS-Based Proposal*. Madrid, Spain: MDPI. <https://doi.org/10.3390/ijerph16162850>
- Watsky, R. 2018. *The Problems With Euclidean Zoning*. Boston, MA: Boston University

Co-design Strategies to Achieve Trust in Urban Living Lab: A Systematic Literature Review

Carla Brisotto¹, Jeffrey Carney¹

¹Florida Institute for Built Environment Resilience, Gainesville, FL

ABSTRACT: Urban Living Lab (ULL) is a placed-based research methodology that engages communities to identify problems and design solutions collectively. The authors engage this methodology to study how urban development can lead to adaptation to socio-ecological variations while maintaining the cultural identities of the communities. The authors collaborate with local underrepresented groups, researchers from different disciplines, and government representatives pursuing interconnectivity and interdisciplinarity. The authors' experience in the coastal town of Port St. Joe and a preliminary literature review showed that the gain of trust amongst a broad array of stakeholders is a limitation of the methodology. ULL first and foremost need to build trust between institutions, citizens, and researchers to engage the community in long-term transformative actions towards climate change adaptation. This paper's goal is a systematic literature review of strategies to enhance trust within a ULL methodology. The authors reviewed systematically several databases of double-peer reviewed articles and proceedings in English from 2000. The authors checked also reference lists to include sources that addressed the issue of trust building to expand the number of publications to be reviewed. Results showed that to limit low or missing trust researchers can (1) create an open-ended research process to include participants in the research design and conduction, (2) facilitate a sense of belonging amongst participants, (3) provide easy access to research tools through educational endeavours and tailored engagement strategies, and (4) establish a relation of credibility with participants by following ethical procedures. Further development of this study is the implementation of strategies to build trust during collaborative design initiatives in the authors' future research endeavours using ULL.

KEYWORDS: Urban Living Lab, Systematic Literature Review, Climate Change, Community Engagement, Trust

INTRODUCTION

Levin et al. (2012) developed the concept of “super wicked problems” to further the concept of “wicked problems” coined in 1973 by Rittel and Webber (1973, 162). Super wicked problems describe phenomena of global urgency and extreme complexity, such as climate change. These types of problems are characterized by high urgency in addressing the situations, unpreparedness of the governmental agencies to address the scale of the issues, and general incapability to envision improving future scenarios. The latter aspect is mainly due to the individual nature of the contemporary society that favors immediate personal benefits rather than necessary behavioral changes to contribute to the long-term interests of the community (Levin et al. 2012, 125; Rittel and Webber 1973). The consequence of this is the production of solutions “with short term time horizons even when the catastrophic implications of doing so are far greater than any real or perceived benefits of inaction” (Levin et al. 2012, 124).

Furthermore, an increasingly diverse population has broadened the spectrum of varied social demands that significantly increase the difficulty of obtaining consensus. Rittel and Webber foresaw the flaws of solving wicked problems by letting the experts decide alone. However, recent literature on case studies approaching wicked problems favors a more socially inclusive approach. Researchers must apply collective engagement and more inclusive and transformative social learning tactics (Mcyntire et al. 2018), especially when addressing climate change problems. Hence, climate change requires a research approach that is more systematic across actors.

In this light, ULL, a model that belongs to the Living Lab (LL) practices, can be used as a research methodology in climate change adaptation studies. ULLs are labs developed in urbanized areas, both rural and metropolitan, at different scales (a cluster of buildings, a neighborhood, a city, a region) (Steen and van Bueren 2017). They integrate contemporaneous research and innovation processes pursuing research that favors transition towards new future scenarios (Nevens et al. 2013, 115). The labs conduct research through transdisciplinary knowledge and collaborative creation between public institutions, private interests, citizens, and researchers leading to transformative outcomes (Hughes et al. 2019, 127; Bulkeley et al. 2019; Menny et al. 2018, 68). The advantage of researching in a real urban context is understanding the problem with the contribution of local stakeholders, influencing the situation in real-time (Frantzeskaki et al. 2018; Franz 2015, 63). Thus, these labs facilitate changes, developing and adjusting solutions throughout the life of the lab, making it the ideal approach to face the challenges caused by climate change that keep evolving.

The researchers of this paper employed this methodology in a pilot study in the coastal town of Port St. Joe (Florida). This project is the first of a more significant endeavour by the Florida Resilient Cities program (FRC)¹. The project aimed to understand how urban development can adapt to socio-ecological variations due to climate change while maintaining the cultural identities of the local communities.

In Port St. Joe, the authors collaborated with local underrepresented groups, researchers, and government representatives pursuing interconnectivity and interdisciplinarity. The ULL process applied in Port St. Joe began with a community workshop that explored the values, goals, and needs of the residents of Port St. Joe. The information gleaned from this workshop become are a range of community-centered designs and research projects that highlight Port St. Joe residents' desire to thrive in their coastal environment. Specifically, this process delivered seven research studies (spanning from green infrastructures, to heritage conservation), engaged 37 faculty members and post-doc researchers from 13 different disciplines (journalism, psychology, architecture, landscape architecture, building construction), 24 local, regional, and national organizations, and more than 100 local participants through numerous workshops.²

Although successful, the experiment of Port St. Joe has highlighted a challenge within the methodology of ULL, namely the difficulties to develop trust consistently across diverse stakeholders. Port St. Joe, like many communities, has a long history of injustice that has led to significant mistrust across racial, economic, and spatial lines. This inequity is evident in the urban divide between the African American neighborhood located North of the train tracks and the rest of the town. As a so-called "neutral broker" the University has an important role to play to help overcoming this gap in equity. However, the two years spent working in Port St. Joe demonstrate the challenge of advocating for the needs of isolated sections of the community while not abandoning the desire for bridges forged across the larger city. As the project developed, the team was faced with the personal and neighborhood politics that had become the expression of this mistrust. For example, certain people would not attend meetings when people they did not agree with were present. To an extent the presence of students and University faculty helped to soften the emotions and encourage broad participation, but the deep divisions remain and still distract from the challenges the community faces. As Culwick et al. noted, trust is the most powerful tool to build understanding and, therefore, collaboration. Case studies experiences "[...] reveal the importance of attitudes of collegiality, respect and generosity in building trust to facilitate mutual learning, achieve the desired co-produced 'output' and change practices around urban sustainability" (Culwick et al. 2019, 14). Nevertheless, several scholars address building trust as a problem (Franz et al. 2015, 52; Van Der Walt et al. 2009; Nesti 2018, 316) that can lead to biased or uneven participation by certain communities while deterring others, as the authors' experience suggested. This paper aims to systematically review the literature to explore how trust can be developed within ULL research methodologies and what and how co-design techniques can support this development.

2.0 METHODOLOGY

A systematic literature review validates a hypothesis or research question by presenting a summary of scholarly evidence rigorously and comprehensively (Petticrew and Roberts, 2008; Siddaway et al., 2019). The scope is to create a review that is trackable for future reference and development. This study aims to respond to the below research questions exploratively:

How can researchers build trust amongst stakeholders engaged in a ULL? How and what techniques of co-design can researchers employ to develop trust?

The researchers systematically reviewed twenty databases³ of double-peer reviewed articles, book chapters, and proceedings published in English from 2000. The researchers focused on the term 'Living Lab' to embrace multiple approaches regarding this placed-based methodology. The authors made two searches looking for references that contain 'Living Lab' in the titles. The first search matches the keyword 'Living Lab' with 'trust,' yielding 87 results. The second search used as second term 'Co-Design' to investigate how the participatory aspect of the methodology influences trust, leading to 79 results. Thirteen articles appear in both searches. The results went under review three times: (1) review of the titles, (2) review of the abstract and (3) review of the text. The latter was included in the narrative of this paper. The authors excluded book chapters from the review as not always open-sourced.⁴ The authors also excluded studies that pursued research focused on individuals rather than communities or groups of people as less aligned with the goals of the ULL adopted by the authors of this paper. Lastly, the authors excluded research that focused solely on marketing outcomes representing profitable goals that do not represent the multidisciplinary ULL adopted by authors. See table 1 for details.

Table 1: Criteria of selections and number of results of the two searches. Source: (authors' table)

	Keywords	Results	Criteria of selection (titles)	First Selection Results	Criteria of selection (abstracts)	Second Selection Results	Criteria of selection (articles)	Second Selection Results
Search 1	Living Lab (title), Trust (any fields)	87	- Exclusion of doubles - Inclusion of studies with an urban component - Exclusion of solely private stakeholders - English language	56	- Exclusion of research that engaged solely private stakeholders - Exclusion of studies that had solely marketing goals	45	- Validation of previous selections - Exclusion of book chapters - Exclusion of research that pursued individual outcomes	29
Search 2	Living Lab (title), Co-Design (any fields)	79	- Exclusion of doubles - Inclusion of studies with an urban component - Exclusion of solely private stakeholders - English language	54	- Exclusion of research that engaged solely private stakeholders - Exclusion of studies that had solely marketing goals	45	- Validation of previous selections - Exclusion of book chapters - Exclusion of research that pursued individual outcomes	22

The searches led to a total of 51 articles. The authors added 8 more articles that the authors selected by checking the reference list to include more sources that address the issue of trust-building (Horsley et al., 2011).

3.0 FINDINGS

The authors collected the findings of the review in table 2 which identifies problems related to trust-building and collaborative design/strategies that address such problems as described in the articles. Due to the interconnectedness of the searches, some results shifted from one search to the other and vice-versa.

Table 2: Results of the review divided by searches. Source: (authors' table)

	Identified Problems	Identified Strategies
Search 1	Reputation of the researchers/Institutions (Smith; Edwards-Schachter et al.)	- Maintain obligation, confidentiality, transparency (Gago and Rubalcaba; Habibipour et al.; Müller et al; Smith; Westerlund et al.; van Geenhuizen; Zavrtnik et al.)
	Respecting personal values within user-groups and between users and stakeholders (van Geenhuizen)	- Researchers intermediation (van Geenhuizen) - Monitoring participants' satisfaction (Leonardi et al.; van Geenhuizen) - Sharing objectives amongst participants (Callari et al.; van Geenhuizen) - Sharing values amongst participants and researchers (Smith) - Participation in groups to get peer supports; selection of participants within already established communities (or similar cultures, demographics, and values, or same neighbourhoods) to leverage on a feeling of belonging (Franz et al.; Matschoss et al.; Sharp and Salter; von Wirth et al.)
	Lack of shared mission (individual needs versus community needs (Leonardi et al.). Lack of feeling useful when mission is not aligned with personal needs (Adeskig et al.; Edwards-Schachter et al.; Habibipour et al.)	- Mapping the community to survey needs and barriers to participation; adjust the pace of the research to the participants (Gray et al.; Müller et al) - Long-Term involvement through strong personal motivation (Culwick et al.; Franz; Juujärvi and Lund; Klautzer et al; Müller et al; Neves et al.) - Encourage knowledge exchange from tacit personal knowledge to local community knowledge to expert researcher knowledge (Callari et al.; Juujärvi and Lund; Westerlund et al.)
	Lack of collaboration between actors (Juujärvi and Lund)	- Engage local individuals to help with research (Papada et al.; Fuglsang et al) - Polycentric governance (Aude et al.) - Reward system (incentives that provide meaning to the research) (Adenskog et al.; van Geenhuizen) - Being involved in the decision process of the research development/two-way communication/ early involvement/ collaborative design (see search 2, first identified strategy and (Amenta et al.; Callari et al.; Cossetta and Palumbo; Culwick et al; Franz; Georges et al.; Lupp et al.; Menny et al.; Sanders and

Identified Problems	Identified Strategies
	<p>Stappers; Sandoval-Almazan and Valle-Criz; Sleeswijk et al.; Steen and van Bueren; Steen et al.; Thees et al.; Westerlund et al.; Zamenopoulos and Alexiou)</p> <ul style="list-style-type: none"> - Conferences, seminars, and training to boost cooperation among stakeholders and develop team building (Akasaka et al.; Edwards-Schachter et al.) - Researchers as facilitators with relational skills (reliability, flexibility, versatility, active listening) (Gago and Rubalcaba; Lehmann et al.; Hakkarainen and Hyysalo)
Technological issues (Adeskig et al.; Habibipour et al.; Georges et al.; Punt et al.) that sometimes lead to a perception of failure (Smith)	<ul style="list-style-type: none"> - Clarify instruction (Adensskog et al.; Georges et al.) - In-person participation (Molinari; Georges et al.)
Social norms as a constraint of dialogue (Matschoss et al.)	<ul style="list-style-type: none"> - Participation in groups and peer supports (Matschoss et al.)
Search 2 Lack of collaboration between actors (Juujärvi and Lund)	<ul style="list-style-type: none"> - Co-Exploration of the territorial context and the community during the data analysis through direct observation; media documentation, and social media analysis (Almirall et al.; Cerreta et al.; Lupp et al.; Marrades et al.; and the other sources) - Co-Creation across researchers/participants (Amenta et al.; Aquilué et al.; Cerreta et al.; Nesti; Engez et al.) <ul style="list-style-type: none"> . Iterative processes lead to novel outcomes (Leminen and Westerlund; Punt et al.) . Learning tacit knowledge through the use of artifacts and thinking tools (Dell'Era and Landoni) . Patterns of knowledge and final descriptive booklet (Akasaka et al.) - Co-Evaluation of each phase of individual and community actions through the development of lists of shared indicators amongst all actors (Cerreta et al.) or through the three impacts analysis (observations, surveys) (Aquilué et al.) - Using placemaking through an familiar location to nurture a safe place (Franz; Franz et al.; von Wirth et al.)
No shared expected outcomes amongst actors (Nesti; Kalinauskaite et al; Lupp et al)	<ul style="list-style-type: none"> - Smart goals either short term or long term via workshops (Cerreta et al.; Kalinauskaite et al.) - Open-ended outcomes and engagement effort (Lupp et al.)
Different values on time used for the co-design phase (working time for government and university, free time for community) (Nesti)	<ul style="list-style-type: none"> - See search 1, third and sixth strategies
Actions are counter to personal or community values, cultures, and habits (Sharp and Salten)	<ul style="list-style-type: none"> - See search 1, third strategy

After analyzing the findings, the authors clustered them into four thematic areas: openness, belonging, accessibility, credibility. The themes are furtherly discussed in the following section.

4.0 DISCUSSION

4.1. Openness

Literature indicates that a lack of collaboration between all the actors (researchers, participants, and other stakeholders) of a study would mine the development of trust amongst them (Culwick et al. 2019; Juujärvi and Lund 2016; Franz et al. 2015, 52) and consequently hinder the success of a ULL. One of the foundational strategies toward trust-building is a participatory technique called co-design, a process composed of at least three phases: co-exploration, co-creation, and co-evaluation.

Co-design engages the researchers with a plethora of participants in a collaborative process toward the identification of problems and solutions (Amenta et al. 2019; Aquilué et al. 2021; Cerreta et al. 2020; Nesti 2018; Engez et al. 2021; Fuglsang et al. 2021, 10; Steen et al. 2011, 53; Sleeswijk et al. 2005, Sanders and Stappers 2008, 6; Zamenopoulos and Alexiou 2018,12). As Sanders and Stappers state, co-design is a “collective creativity [...] applied across the whole span of a design process” (2008). Through co-design, each actor can contribute to the development of the research, even those “people not trained in design” (Sanders and Stappers 2008, 8). In fact, co-design can nurture creativity in people (Zamenopoulos and Alexiou 2018, 26, Sanders and Stappers 2008, 14), supporting the engagement of participants that are “experts of their experiences” (Steen et al. 2011, 53; Sleeswijk et al. 2005, Sanders and Stappers 2008, 6; Menny et al. 2018, 69). Acknowledging the participants’ expertise disenfranchised them, giving them power within the research project across all the phases. For instance - in an urban environment - the first phase of co-exploration let researchers learn about the site precisely through the creative work of the residents, the analysis of media documentation, and social media analysis (Almirall et al. 2012; Cerreta et al. 2020; Lupp et al. 2021; Marrades et al. 2021; Sanders and Stappers 2008, 8, Zamenopoulos and Alexiou 2018, 13). After exploring the problem, the phase of co-creation engages all the actors in an iterative ideation process that scholars see as the propeller of

innovative outcomes (Leminen and Westerlund 2016; Punt et al. 2020). There are different tools and strategies to achieve this collective goal tailored to specific ULL objectives, goals, and contextual characteristics. Nonetheless, there seems to be a consensus across the literature to indicate sensorial artifacts, participatory mapping, and informative media materials as toolkits of ULL (Akasaka et al. 2020; Dell’Era and Landoni, 2014).

In order to be successful, researchers must understand that there might be different design goals amongst actors and even between researchers and participants (Callari et al. 2019; van Geenhuizen 2019; Nesti 2018; Kalinauskaite et al. 2021; Lupp et al. 2021). Consequently, researchers must be aware that they might pursue actions that contrast with personal or community values, cultures, beliefs, and habits (Sharp and Salten). In this light, ULL must be carried as an open-ended process (Lupp et al. 2021) in which “transparency and communication of actions and activities create openness to the innovation process and to change in the making itself” (von Wirth et al. 2019, 242). Goals and engagement tools are collaboratively evaluated (Aquilué et al. 2021; Cerreta et al. 2020; Kalinauskaite et al. 2021) to adjust to different sets of beliefs throughout the project.

4.2. Belonging

Being involved in the decision process of the research development would support trust-building, as described in the section openness. Considering participants essential for understanding the problem and the design of the solution help create a collaborative environment generated from a feeling of belonging. Unfortunately, this sense of belonging is limited by multiple factors: different sets of values, uneven preparation to understand the research topic, and the length of the study.

Lack of trust can derive from different values within a participant group or between groups (Smith 2013; van Geenhuizen 2019). As noted by Matschoss et al., “having something in common, be it a place of residence or an interest, was believed to help establish mutual trust and a sense of communality” (2021, 141-142). When participants feel amongst peers, a support system takes place, creating opportunities for learning and exchanging information (Matschoss et al. 2021, 146-147; Sharp and Salter 2017, 5). Hence, to facilitate a sense of belonging, researchers should try recruiting participants amongst established communities or creating groups of participants with similar interests organizing the community engagement, preferably in small groups. It is essential to monitor the participants’ satisfaction to assess the homogeneity level within participants and test the grade of interchanges created within each group. Leonardi et al. suggest that monitoring satisfaction also helps respect each participant’s personal values and their level of self-determination (2019, 6), supporting participants’ personal motivation to join the research.

A sense of belonging should also grow between participants and researchers (Smith 2013). This level of engagement can be achieved at least in two ways—the first one regarding the participants, the second the researchers. In the first case, it is helpful to recruit local individuals to co-run the community engagement activities, becoming essential collaborators of the research at large. The local community engagers will not be outsiders so that participants would trust them more (Papada et al. 2021, 15). In the second case, researchers need to close the knowledge gap between them and the participants engaging in educational workshops and seminars. Educating the participating groups on the research topic is essential to engage the lab in deep discussions (Edwards-Schachter et al. 2012, 385).

The Urban Ecology CityLab (a ULL in Cape Town focusing on the ecology of the city) and TULab (ULLs in multiple locations in Tanzania focusing on sustainability and urbanization) cases demonstrates that to build trust amongst practitioners, researchers, the broader public, and stakeholders the labs must create proximity to the issues studied and amongst participating members in this way nurturing the appreciation of everyone’s perspectives. This process develops over time, and in fact, it is encouraged to engage participants at the early stage of the research (Franz 2015, 64; Menny et al. 2018, 69; Steen and van Bueren, 2017, 29). In this way, co-design can be carried through multiple sessions with the same core of researchers (Culwick et al. 2019, 13; Neves et al. 2012, 118).

4.3. Accessibility

Another obstacle to the development of trust can be uneven access to the research. The limitation regards difficulties to engaging with underserved groups (Franz, 2015:63; Menny et al. 2018: 73), to overcome the technological divide (Adensskog et al.2017; Georges et al. 2015; Habibipour et al. 2018; Punt et al. 2020) and to work with different participants’ schedule and availability (Nesti 2018).

ULL relies heavily on engagement; however, the risk is to engage only the most active residents rather than the unheard groups. This challenge can harm the research’s outcomes if the topic of study is relevant for diverse groups of people. In this light, recruiting local representatives helping with the community engagement might be helpful, as discussed above. In engaging different groups or unheard communities, another hindrance can come from social constraints, especially if the research topic is sensitive. Matschoss et al. reported that in a sustainability study aiming to reduce consumption of domestic water, participants were not comfortable discussing personal and private habits in front of others (2021). Peer supports can help break these barriers helping the more reluctant participants to access the research project.

Several studies indicated that the technological divide is a primary source of concern when the engagement employs online questionnaires, informative websites, technological devices, and other digital tools (Adenskog et al. 2017; Georges et al. 2015; Habibipour et al. 2018; Punt et al. 2020). The problem generates when people are not used to a digital tool due to a generational gap (eldest people) or income gap (a low-income population that does not possess the required equipment or a stable Internet connection). This divide can lead to a perception of failure amongst those participants (Smith 2013), reducing their engagement level or dropping out from the research. Hence, ULL researchers, when using digital tools, must clarify the engagement exercise with straightforward instruction (Adenskog et al. 2017; Georges et al. 2015) and create alternative analogical opportunities whenever possible. This flexible approach can be achieved by early assessing possible participation barriers and adjusting the research pace to the participants' (Gray et al. 2014; Müller et al. 2015).

Lastly, access to research can be complicated by the schedule of the research. Researchers and organizational stakeholders can participate during traditional working hours, while participants from the local site can see this schedule as a limitation (Nesti 2018).

4.4. Credibility

Literature covers the last theme extensively, proving that the question of credibility is far to be an obvious achievement. The reputation of researchers or institutions is the first issue. Participants would have to trust them even before starting the research study (Smith 2013; Edwards-Schachter et al. 2012). A well-known institution might have more credibility, but that relationship must be nurtured and grown with the participants throughout the ULL process.

Maintaining confidentiality of gathered information and transparency on how to treat that data throughout the process is the main objective to achieve credibility (Gago and Rubalcaba 2020; Habibipour et al. 2018; Müller et al. 2015; Smith 2013; Westerlund et al.; Zavrtnik et al. 2019; van Geenhuizen 2019, 930). Additionally, researchers of ULL need to become facilitators with optimal relational skills (reliability, flexibility, versatility, active listening) (Gago and Rubalcaba 2020; Hakkarainen and Hyysalo 2016; Lehmann et al. 2015). These characteristics at the institutional or researchers level imply that ULL must engage in a long-term engagement to let the credibility relationship develop over time. This longitudinal approach requires strong participants' personal motivation to join the ULL (theme discussed in the above sections).

The credibility of a ULL is also recognized when it builds capacity. In other words, the research led to a series of actions that keep going even after the ULL ends and the researchers leave the site. Participants can directly experience the outcomes of the ULL and feel empowered by the ability to carry the outcomes at another level, perhaps implementation. Building this capacity occurs when the ULL can exchange knowledge from the tacit personal knowledge to the local community knowledge to the expert researcher knowledge (Callari et al. 2019; Juujärvi and Lund 2016; Westerlund et al. 2018) so that participants become independent from researchers.

CONCLUSION

ULLs can visualize a complex problem even in the absence of comprehensive information. This methodological ability becomes relevant for climate change studies, which involve future scenarios that are still unfolding and operate in deeply uncertain contexts. Yet, a lack of trust amongst the community toward the ULL can hinder the benefit of this methodology. This systematic literature review suggests that the educational role of the researchers is essential in building trust. Creating opportunities for learning about climate change opens a dialogue that integrates scholar knowledge with local knowledge delivering scientific facts to the community, which informs the research with their local expertise.

Multiple analogical and digital tools support equitable access to the ULL, respecting the diverse demography of groups, their possible different work paces and potentially increasing their personal motivations. The most significant result is the awareness that ULLs need to have long-time impacts on improving the credibility of the institution/researchers for further studies in the future. ULLs must create local capacity that can bring the research's outcomes forward after the lab ends. Results of this study will be incorporated and tailored in the community engagement phase of the second FRC project in Jacksonville, a project the authors conduct in Spring 2022.

REFERENCES

- Adenskog, M., Åström, J., Ertiö, T., Karlsson, M., Ruoppila, S., and Thiel, S.K. "Balancing Potential and Risk: The Living Lab Approach in Mobile Participation Research," *Lecture Notes in Computer Science*, no. 10429 (2017): 12–23.
- Akasaka, F., Yasuoka, M., Nakatani, M., Kimura, A. and Ihara, M. "Patterns for Living Lab Practice: Describing Key Know-How to Promote Service Co-Creation with Users." *International Journal of Automation Technology* 14, no. 5 (2020): 769–78.
- Almirall, E., Lee, M., and Wareham, J. "Mapping Living Labs in the Landscape of Innovation Methodologies." *Technology Innovation Management Review* 2, no. 9 (2012): 12–18.
- Amenta, L., Attademo, A., Remøy, H., Berruti, G., Cerreta, M., Formato, E., Palestino, M.F. and Russo, M. "Managing the Transition towards Circular Metabolism: Living Labs as a Co-Creation Approach." *Urban Planning* 4, no. 3 (2019): 5–18.
- Aquilue, I., Caicedo, A., Moreno, J., Estrada, M., and Pages, L. "A Methodology for Assessing the Impact of Living Labs on Urban Design: The Case of the Furnish Project." *Sustainability* (Basel, Switzerland) 13, no. 8 (2021): 4562.

- Aude, Z.H., Martin, J., Lupp, G., Linnerooth-Bayer, J., and Pauleit, S. "Designing a Resilient Waterscape Using a Living Lab and Catalyzing Polycentric Governance." *Landscape Architecture Frontiers* 7, no. 3 (2019): 12.
- Brown, T., & Martin, R. "Design for Action: How to Use Design Thinking to Make Great Things Actually Happen." *Harvard Business Review*, no. 9 (2015): 56.
- Buchanan, R. "Wicked Problems in Design Thinking." *Design Issues* 8, no. 2 (1992): 5.
- Callari, T., Moody, L., Saunders, J., Ward, G., Holliday, N., and Woodley, J. "Exploring Participation Needs and Motivational Requirements When Engaging Older Adults in an Emerging Living Lab." *Technology Innovation Management Review* 9, no. 3 (2019): 38–49.
- Cerreta, M., Elefante, A., and La Rocca, L. "A Creative Living Lab for the Adaptive Reuse of the Morticelli Church: The SSMOLL Project." *Sustainability (Basel, Switzerland)* 12, no. 24 (2020): 10561.
- Chronéer, D., Ståhlbröst, A., and Habibipour, A. "Urban Living Labs: Towards an Integrated Understanding of their Key Components." *Technology Innovation Management Review* 3 (2019): 50.
- Culwick, C., Washbourne, C., Anderson, P. M. L., Cartwright, A., Patel, Z., & Smit, W. "CityLab reflections and evolutions: Nurturing knowledge and learning for urban sustainability through co-production experimentation." *Current Opinion in Environmental Sustainability* 39 (2019): 9–16.
- Dell'Era, C., and Landoni, P. "Living Lab: A Methodology between User-Centred Design and Participatory Design." *Creativity and Innovation Management* 23, no. 2 (2014): 137–54.
- Edwards-Schachter, M.E., Matti, C.E., and Alcántara, E. "Fostering Quality of Life through Social Innovation: A Living Lab Methodology Study Case." *The Review of Policy Research* 29, no. 6 (2012): 672–92.
- Engez, A., Leminen, S., and Aarikka-Stenroos, A. "Urban Living Lab as a Circular Economy Ecosystem: Advancing Environmental Sustainability through Economic Value, Material, and Knowledge Flows." *Sustainability (Basel, Switzerland)* 13, no. 5 (2021): 2811.
- Frantzeskaki, N., Van Steenbergen, F., and Stedman, R. C. Sense of place and experimentation in urban sustainability transitions: The Resilience Lab in Carnisse, Rotterdam, the Netherlands. *Sustainability Science* 13, no. 4 (2018): 1045.
- Franz, Y. "Designing Social Living Labs in Urban Research." *Info* 17, no. 4 (2015): 53.
- Franz, Y., Tausz, K., and Thiel, S. K. "Contextuality and Co-Creation Matter: A Qualitative Case Study Comparison of Living Lab Concepts in Urban Research." *Technology Innovation Management Review* 5, no. 12 (2015): 48–55.
- Fuglsang, L., Vorre Hansen, A., Mergel, I., and Taivalsaari Røhnebæk, M. "Living Labs for Public Sector Innovation: An Integrative Literature Review." *Administrative Sciences* 11, no. 2 (2021): 58.
- Gago D. and Rubalcaba, L. "The Role of Soft Skills to Leverage Co-Creation in Living Labs: Insights from Spain." *The Innovation Journal* 25, no. 2 (2020): 1–23.
- Geenhuizen, M.S van. "Applying an RRI Filter in Key Learning on Urban Living Labs' Performance." *Sustainability (Basel, Switzerland)* 11, no. 14 (2019): 3833.
- Georges, A., Schuurman, D., Baccarne, B., and Coorevits, L. "User Engagement in Living Lab Field Trials." *Info (Cambridge, England)* 17, no. 4 (2015): 26–39.
- Gray, M., Mangyoku, M., Serra, A., Sánchez, L., and Aragall, F. "Integrating Design for All in Living Labs." *Technology Innovation Management Review* 4, no. 5 (2014): 50–59.
- Habibipour, A., Georges, A., Ståhlbröst, A., Schuurman, D., and Bergvall-Kåreborn, B. "A Taxonomy of Factors Influencing Drop-Out Behaviour in Living Lab Field Tests." *Technology Innovation Management Review* 8, no. 5 (2018): 5–21.
- Hakkarainen, L., and Hyysalo, S. "The Evolution of Intermediary Activities: Broadening the Concept of Facilitation in Living Labs." *Technology Innovation Management Review* 6, no. 1 (2016): 45–58.
- Horsley_T, Dingwall_O, Sampson_M. "Checking Reference Lists To Find Additional Studies For Systematic Reviews." *Cochrane Database of Systematic Reviews*, no. 8 (2011): Art. No.: MR000026.
- Hughes, H., Foth, M., and Mallan, K. "Social Living Labs for Informed Learning: A Conceptual Framework of Interprofessional Education in Community Healthcare." *Journal of Information Literacy* 13, no. 2 (2019): 112–135.
- Juujärvi, S., and Lund, V. "Enhancing Early Innovation in an Urban Living Lab: Lessons from Espoo, Finland." *Technology Innovation Management Review* 6, no. 1 (2016): 17–26.
- Kalinauskaitė, I., Brankaert, R., Lu, Y., Bekker, T., Brombacher, A., and Vos, S. "Facing Societal Challenges in Living Labs: Towards a Conceptual Framework to Facilitate Transdisciplinary Collaborations." *Sustainability (Basel, Switzerland)* 13, no. 2 (2021): 614.
- Klautzer, L., Yeon Hong, S., and Narayan, R. "More than a Thought Experiment - Conceptualizing and Implementing an Urban Living Lab." *IOP Conf. Ser.: Earth Environ. Sci* 588, no. 3 (2020).
- Lehmann, V., Frangioni, M. and Dubé, P. "Living Lab as Knowledge System: An Actual Approach for Managing Urban Service Projects?" *Journal of Knowledge Management* 19, no. 5 (2015): 1087–1107.
- Leminen, S., Nyström, A.G., Westerlund, M., and Kortelainen, M. "The Effect of Network Structure on Radical Innovation in Living Labs." *The Journal of Business & Industrial Marketing* 31, no. 6 (2016): 743–57.
- Leonardi, C., Doppio, N., Lepri, B., Zancanaro, M., Caraviello, M., and Pianesi, F. "Exploring Long-Term Participation within a Living Lab: Satisfaction, Motivations and Expectations." *Nordic Conference on Human-Computer Interaction, NordiCHI '14, 2014*, 927–30.
- Levin, K., Cashore, B., Bernstein, S., and Auld, G. "Overcoming the tragedy of super wicked problems: constraining our future selves to ameliorate global climate change." *Policy Sciences* 45, no. 2 (2012): 123.
- Lupp, G., Zingraff-Hamed, A., Huang, J., Oen, A., and Pauleit, S. "Living Labs-A Concept for Co-Designing Nature-Based Solutions." *Sustainability (Basel, Switzerland)* 13, no. 1 (2021): 188.
- Maher, R., Maher, M., Mann, S., and McAlpine, C. A. "Integrating design thinking with sustainability science: a Research through Design approach," *Sustainability science* 13, no. 6 (2018): 1565-1587.
- Marrades, R., Collin, P., Catanzaro, M., and Mussi, E. "Planning from Failure: Transforming a Waterfront through Experimentation in a Placemaking Living Lab." *Urban Planning* 6, no. 1 (2021): 221–34.
- Matschoss, K., Fahy, F., Rau, H., Backhaus, J., Goggins, G., Grealis, E., Heiskanen, E., et al. "Challenging Practices: Experiences from Community and Individual Living Lab Approaches." *Sustainability: Science, Practice, & Policy* 17, no. 1 (2021): 136–52.
- Macintyre, T., Lotz-Sisitka, H., Wals, A., Vogel, C., and Tassone, V. "Towards Transformative Social Learning on The Path to 1.5 Degrees." *Current Opinion in Environmental Sustainability* 31 (2018): 80–87.

- Mendizabal, M., Heidrich, O., Feliu, E., García-Blanco, G., and Mendizabal, A. "Stimulating Urban Transition and Transformation to Achieve Sustainable and Resilient Cities." *Renewable & Sustainable Energy Reviews*, 94 (2018): 410–418.
- Menny, M., Palgan, Y. V., and McCormick, K. "Urban living labs and the role of users in co-creation." *Gaia (Heidelberg, Germany)* 27, no. 1 (2018): 68–77.
- Molinari, F. "Living Labs as Multi-Stakeholder Platforms for the Egovernance of Innovation." *ACM International Conference Proceeding Series*, ICEGOV '11, (2011): 131–40.
- Müller, C., Hornung, D., Hamm, T., and Wulf, V. "Practice-Based Design of a Neighborhood Portal: Focusing on Elderly Tenants in a City Quarter Living Lab." *Conference on Human Factors in Computing Systems*, CHI '15, (2015): 2295–2304.
- Nesti, G. "Co-Production for Innovation: The Urban Living Lab Experience." *Policy & Society* 37, no. 3 (2018): 310–25.
- Nevens, F., Frantzeskaki, N., Gorissen, L., and Loorbach, D. "Urban Transition Labs: Co-Creating Transformative Action for Sustainable Cities." *Journal of Cleaner Production* 50 (2013): 111–122.
- Papada, L., Balaskas, A., Katsoulakos, N., Kaliampakos, D., and Damigos, D. "Fighting Energy Poverty Using User-Driven Approaches in Mountainous Greece: Lessons Learnt from a Living Lab." *Energies (Basel)* 14, no. 6 (2021): 1525.
- Petticrew, M., and Roberts, H. (2008). *Systematic reviews in the social sciences: a practical guide*. Wiley.
- Punt, E., Afroz, A., and Pettit, C. "Precinct Scale Living Laboratories: Case Study of Randwick Living Lab." *ISPRS Annals of the Photogrammetry, Remote Sensing and Spatial Information Sciences VI-4/W2-2020* (2020): 127–34.
- Rittel, J., and Webber, M. "Dilemmas in a General Theory of Planning." *Policy Sciences* 4, no. 2 (1973), 155
- Sanders, B., and Stappers, P. "Co-Creation and the New Landscapes of Design," *Co-Design* 4, no.1 (2008): 5-18
- Sandoval-Almazan, R., and Valle-Cruz, D. "Open Innovation, Living Labs and Public Officials: The Case of 'Mapaton' in Mexico." *ACM International Conference Proceeding Series*, ICEGOV '17 (2017): 260–65.
- Sharp, D., and Salter, R. "Direct Impacts of an Urban Living Lab from the Participants' Perspective: Livewell Yarra." *Sustainability (Basel, Switzerland)* 9, no. 10 (2017): 1699.
- Schuurman, D. and Tönurist, P. "Innovation in the public sector: exploring the characteristics and potential of living labs and innovation labs", *Technology Innovation Management Review* 7, no. 1 (2017): 7-14.
- Smith, C. "Factors Affecting Conditions of Trust in Participant Recruiting and Retention: A Position Paper." *Conference on Information and Knowledge Management*, LivingLab '13 (2013): 13–14.
- Sleeswijk V. F., Stappers, P. J., Van der Lugt, R., and Sanders, E. B. N. "Context Mapping: Experiences from Practice. *CoDesign* 1, no. 2 (2005): 119-149.
- Steen, K., & van Bueren, E. "The Defining Characteristics of Urban Living Labs." *Technology Innovation Management Review* 7, no. 7 (2017): 21.
- Steen, M., Manschot, M., and De Koning, N. "Benefits of Co-design in Service Design Projects." *International Journal of Design* 5, no. 2 (2011): 53–60.
- Siddaway, A. P., Wood, A. M., and Hedges, L. V. "How to Do a Systematic Review: A Best Practice Guide for Conducting and Reporting Narrative Reviews Meta-Analyses, and Meta-Syntheses." *Annual Review of Psychology* 70, no. 1 (2019): 747–770.
- Thees, H., Pechlaner, H., Olbrich, N., and Schuhbert, A. "The Living Lab as a Tool to Promote Residents' Participation in Destination Governance." *Sustainability (Basel, Switzerland)* 12, no. 3 (2020): 1120.
- Westerlund, M., Leminen, S., and Habib, C. "Key Constructs and a Definition of Living Labs as Innovation Platforms." *Technology Innovation Management Review* 8, no. 12 (2018): 51–62.
- Wirth, T. von, Fuenfschilling, L., Frantzeskaki, N., and Coenen, L. "Impacts of Urban Living Labs on Sustainability Transitions: Mechanisms and Strategies for Systemic Change through Experimentation." *European Planning Studies* 27, no. 2 (2019): 229–57.
- Zamenopoulos T., and Alexiou K. (2018). *Connected communities*. Bristol: The University of Bristol.
- Zavratnik, V., Superina, A., and Stojmenova Duh, E. "Living Labs for Rural Areas: Contextualization of Living Lab Frameworks, Concepts and Practices." *Sustainability (Basel, Switzerland)* 11, no. 14 (2019): 3797.
- Van Der Walt S. et al. "Community Living Lab as a Collaborative Innovation Environment." *Issues in Informing Science & Information Technology Education* 6, (2009): 421-436.

ENDNOTES

¹ The Florida Resilient Cities is a program led by Jeff Carney at the Florida Institute for Built Environment Resilience at the University of Florida. The scope of the program is to create a network of resilient communities across Florida through a combination of service, teaching, and research combining scientific data to design thinking. The program offers a design approach to community-scale adaptation and encourages cities to view climate change solutions as opportunities to invest in redevelopment and adaptive transformation.

² To learn more about the Port St. Joe project visit the digital exhibition at:
<https://ufl.maps.arcgis.com/apps/Cascade/index.html?appid=f97f0d3ca436415ba2066080cb3da857>

³ IngentaConnect (44), DOAJ Directory of Open Access Journals (44), SciTech Premium Collection (41), ProQuest Central China (30), Technology Collection (27), ABI/INFORM Collection (23), Engineering Collection (22), Web of Science (22), Engineering Database (22), Materials Science & Engineering Collection (22), Gale Academic OneFile (15), Natural Science Collection (14), Agricultural & Environmental Science Collection (12), Sustainability Science Abstracts (11), Gale Academic OneFile Select (6), ACM Digital Library (6), Advanced Technologies & Aerospace Collection (6), Business Source Premier (5), Free Medical Journals (5), Social Science Premium Collection (5).

⁴ The authors believe that book chapters are indispensable addition to scholarly knowledge. However, the authors decided to exclude book chapters as not always open-sourced to maintain the rigorosity of this systematic review.

Building a Workflow to Model a Green Façade in a Graphical User Interface for EnergyPlus

Sydney Collin¹, Passe Ulrike^{1,2}

¹Center for Building Energy Research, Iowa State University, Ames, IA

²Department of Architecture, Iowa State University, Ames, IA

ABSTRACT: Based on global concerns to develop climate resilient cities, green roofs and green walls of various complexities have been studied and promoted to address urban micro-climate challenges as well as indoor overheating. This study proposes a workflow to model a green façade (foliage only, air gap and no growing media) using Design Builder (DB)/EnergyPlus (EP). Although green façades are deemed less effective than living walls (foliage with vertical growing media) for passive cooling purposes, they are less costly and can be grown easily by anyone. Thus, they could provide feasible passive retrofit opportunities for low income families to reduce cooling loads in their homes. DB/EP is widely used to assess building energy performance, but provides limited options to analyze the impact of trees or vegetated surfaces on buildings' thermal behavior. Indeed, the most flexible features available for the user are shading devices, which currently do not include latent, radiative and convective heat transfers. One available option would be to use the existing green roof module, but this method has its drawbacks: the EP/DB documentation does not recommend using it vertically and the software does not allow to simulate multiple green surfaces simultaneously. Some studies have developed empirical or mathematical methods to model different types of green walls but, to our knowledge, it has never been fully integrated into Energy Plus and is not readily accessible for users. Based on a literature review, this study investigates the current options available to abstract a green façade and highlights the pros and cons of each option. First, it focuses on the green roof module, because it is based on established vegetation models and has been used in a variety of recent peer-reviewed studies. Then, different approaches to derive a green façade model from existing methods are discussed as recommendation for future work.

KEYWORDS: Green Façade, Passive Cooling, Resilience, EnergyPlus

INTRODUCTION

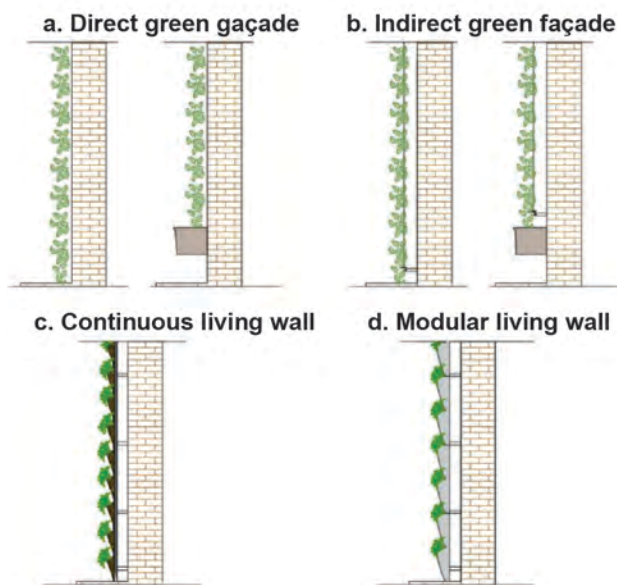

Figure 1: Different types of green walls. Direct and indirect green façades: plants can be either planted into the soil or boxes. Continuous living walls and modular living walls: plants can grow on lightweight absorbent screens (c.) or on panels with specific supporting elements (d.). Source: (Palermo et al. 2020)

In the wake of worldwide intense heat events and based on global concerns to develop climate resilient cities, more and more local authorities are willing to take actions. However, to build the appropriate policies, decision makers need to assess the different levels of vulnerability in their population. To that end, researchers have developed a comprehensive modeling framework to help local authorities of the city of Des Moines (IA) to build targeted climate resilience strategies, especially for low-resource neighborhoods (Passe et al. 2020). The neighborhood this project focuses on is very vulnerable to extreme heat. The local climate is characterized by hot and humid summers, the buildings are poorly insulated and its population does not always have a functional air conditioning (AC) system.

In this context, passive cooling approaches could provide feasible retrofit opportunities for low-income households. Indeed, there is a wide range of passive cooling techniques and systems (shading, natural ventilation, geothermal cooling, etc.) that help consume less energy than an active cooling system such as AC and reduce heat flux into buildings (Fagbule et al. 2021). They are all based on either heat avoidance or heat dissipation principles (Prieto et al. 2018).

Building integrated vegetation (BIV) such as green roofs or green walls fall into the passive building strategy category. Green walls of various complexities have been studied and promoted to address Urban Heat Island

(UHI) mitigation, biodiversity improvement and urban water management (Manso et al. 2015). Otherwise known as vertical greening systems (VGS), green walls have been mostly examined for their ability to reduce building energy demand (especially for cooling) and improve resident's thermal comfort by acting as solar screens while providing evaporative cooling. As shown in Figure 1, green walls can be broken down into two main categories: green façades (a. and b.) and living walls (c. and d.). The first category refers to more traditional vertical greening systems using climbing (ivy, vines) or hanging plants directly or indirectly applied to a wall (with a supportive system such as trellises). Living walls are more recent, allow more coverage and plant diversity. This category features a variety of modular or continuous systems that can support growing media, irrigation and drainage systems.

Although green façades are deemed less effective than living walls for cooling load reduction, they are usually less costly (Malys et al. 2014; Manso et al. 2015) and can be grown easily by anyone. Thus, this paper will focus on green façades with plants in pots applied indirectly and supported by trellises or nets (see Figure 1. b.).

The final purpose of this work will be to assess the performances of this system by modelling them in DesignBuilder (DB) and to compare the results with experimental data collected in the summer of 2020 (Fagbule et al. 2021). While DB is a proprietary Graphical User Interface (GUI), it uses a free, open-source and widely used cross platform building simulation software called EnergyPlus (EP) as its main computational engine. One major shortcoming with DB is that there are currently no turnkey and straightforward solutions to accurately and simply model a green wall. Consequently, based on DB/EP documentation and a literature review, this study investigates the current options available to abstract a green façade, highlights the pros and cons and explores different approaches to derive a specific green façade.

Figure 2 shows a graphic representation of how we could abstract our green façade and move from reality to a mathematical model that will serve as a guideline to develop a specific green façade module in DB. A 'module' is a part, a component of a software or a program with which the user will directly interact (by setting inputs) and a 'model' refers to the underlying equations of this program.

Currently, DB/EP provides many modelling options for solar control but only one – the green roof module – allows to account for both shading and evapotranspiration (ET). Therefore, it has major drawbacks. These will be discussed in more details in the 'Results' section.

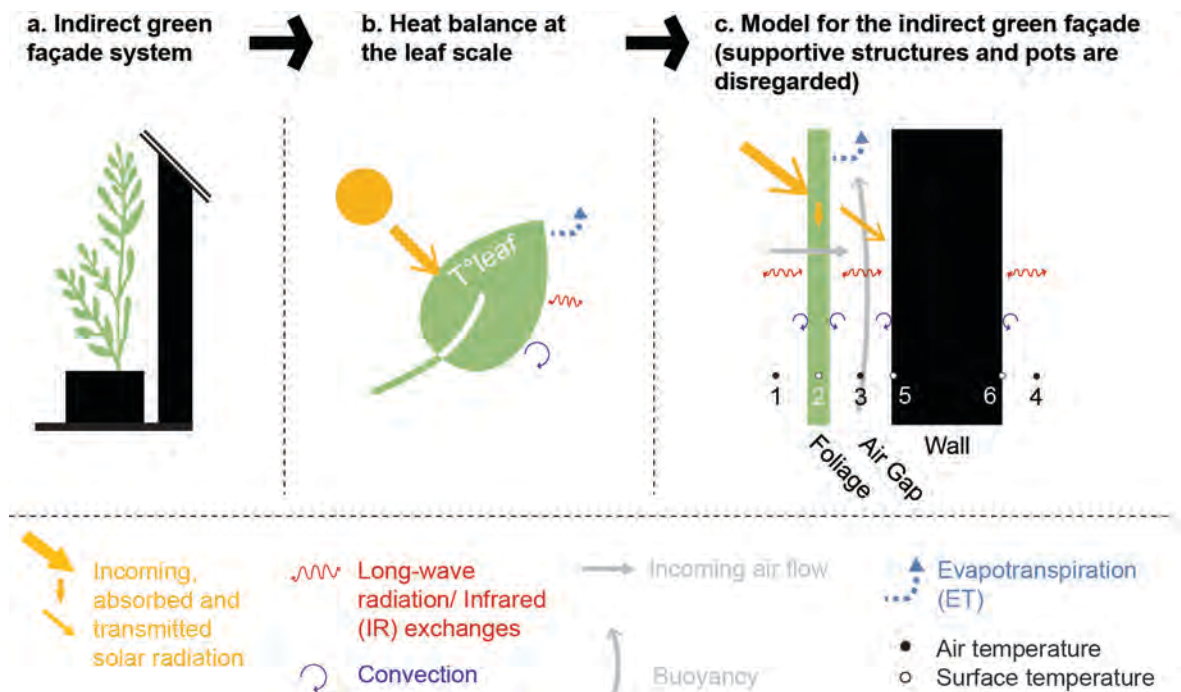

Figure 2: Abstracting the indirect green façade so that it can be mathematically represented.

The energy balance of this system, more specifically of the foliage layer, involves three types of heat fluxes that will influence the leaf temperature: radiative heat fluxes, latent heat flux and sensible heat flux (Figure 2.b and c).

In radiative heat fluxes, solar radiation is the main incoming energy source and the principal driver for ET in the leaves. A fraction of this energy is absorbed by the plants and the other is transmitted to the wall behind. In this category, long wave radiation is also exchanged between the system and its surroundings (the ground and any other surfaces, such as walls).

Latent heat flux refers to energy released or absorbed for phase changes (solid, gas, liquid) while sensible heat flux only involves temperature variation in the system without any phase change. So the mathematical formulation of latent heat flux in this system depends on the evapotranspiration rate of the foliage layer, more precisely the vaporization of water from the leaf's surface. Common correlations for estimating plant evapotranspiration are based on the Penman-Monteith equations which are used in a method developed by the United Nations Food and Agriculture Organization (Allen et al. 1998) to compute crop water requirements. However, these equations have been applied to other contexts (i.e. to calculate trees ET rate).

Finally, sensible heat flux depends on convective heat transfer near and in the foliage layer. If the foliage layer is considered as 'one big leaf' (Flores Larsen et al. 2014), only the convective heat transfer coefficients on the inside and outside face of the foliage layer would be modeled (Figure 2, c.). Buoyancy effect and convection in the air gap should also be accounted for. When modeling the air gap, wind could be an important parameter to consider. In fact, some studies have shown that vegetation can act as a wind barrier (Perini et al. 2011). In the case of green façades, it appears that direct green façades show a better potential at wind reduction than indirect systems because the wind speed values increase again in the air gap after having been lowered by the foliage layer. However, the authors suggest that there is an optimal air gap thickness of 4 to 6 cm which minimizes this rise in wind velocities by getting an almost stagnant air layer. So assuming whether the air gap is stagnant or ventilated will be influenced by its thickness and, air penetration which in turn depends on the foliage coverage, thickness and density. The Leaf Area Index (LAI) is a widely used indicator that gives information on foliage coverage. The latter represents the projected leaf area per a surface unit area and is linked but distinct from the fractional vegetative coverage which is the fraction of surface directly covered by one or more leaves or the shaded surface (Sailor 2008). Note that, for the purpose of modeling a direct green façade, other authors chose to disregard this 'wind barrier' potential because of the lack of "robust studies on decreased values of convective heat transfer coefficients for wide ranges of vegetated façade types" (Susorova et al. 2013,15). So we may face the same problem in the case of indirect green façades.

1.0 METHOD

This study is based on a literature and software documentation review. We investigated the current modeling options available in Design Builder and EnergyPlus to abstract the green façade (section 2.1). This was done to evaluate their pros and cons and get a better understanding of how we could update current features and adapt them to our needs. We compared EP user inputs with DB inputs as well. In parallel, we analyzed the underlying equations of different models in peer-reviewed literature (section 2.2) and confronted them with warnings and recommendations from the software's documentation. This process is the first step to investigate how we can modify available models within DB and eventually create our own green façade module.

Five publications were selected for equation analysis (Sailor 2008, Susorova et al. 2013, Malys et al. 2014, Flores Larsen et al. 2015, Kalani et al. 2017). These can be divided into two categories: green façades models and living walls models (see Figure 1). For the first category, research publications from Flores Larsen et al. 2014 and 2015 were our main guideline, because it addresses a process closest to what we are trying to model (indirect green façade). Also, the authors used EnergyPlus as a simulation tool with available components such as the window shade device or the building shading object which will be discussed in greater details in section 2.1. On the other hand, Susorova et al. 2013 developed their own mathematical model for a direct green façade and validated it with surface temperature values captured on ivy covered walls. In the second category, Sailor 2008 was our reference because it gives a comprehensive presentation of the EP green roof model as well as a sensitivity analysis. The study made by Kalani et al. 2017 was also selected because it uses EP green roof model in a vertical fashion. Their work uses correlations from Malys et al. 2014, which was also reviewed although it uses a different software called SOLENE-Microclimat/Code Saturne.

Two additional studies were added to this selection to examine their use of the EP green roof model (Pastore et al. 2017, Assimakopoulos et al. 2020). They did not propose a model but provided a good literature overview.

2.0 RESULTS

This section will review the different modeling options available in DB and their limitations when abstracting a green façade. Based on this review, the green roof module was analysed further in spite of limitations. This analysis could then lead to develop our own green façade module based on these tools and the equations reviewed in different papers. The models are presented starting with the one which best describes the underlying physics to the simplest one.

2.1. Assessment on the four modelling options in Design Builder and EnergyPlus and possible improvements on existing features

a-Green Roof Material (GRM):

The green roof material allows the user to model a vegetated layer with an irrigated soil layer on a roof surface. It is applied as the outermost material of the roof assembly. The user needs to input geometric, optical and evapotranspiration properties for the plant layer (LAI, leaf reflectivity, stomatal resistance, etc.) as well as thermal and moisture properties for the growing media. The module also includes an option for irrigation.

Using this modelling option could be determined a good starting point to abstract the green façade because it was validated and is based on recognized vegetation models such as the “Army Corps of Engineers’ FASST vegetation models” (Sailor 2008, 1467). However, this module does have its drawbacks. It was not designed to be used on vertical surfaces. The main warning comes from Design Builder Help File which does not recommend using it vertically because of the lack of validation. Then,

the convective heat transfer coefficients between the foliage and the soil are automatically calculated by the code (the user is not allowed to change them) from special relationships that are valid for horizontal grass. These coefficients are not adequate for vertical plants. (Flores Larsen et al. 2014, 1766)

Despite these recommendations, we found three studies using the GRM in a vertical fashion to model a living wall. Two of them (Pastore et al. 2017, Assimakopoulous et al. 2020) directly apply it to vertical surfaces and do not address this problem. The third study (Kalani et al. 2016) presents a living wall model which is based on the GRM and correlations developed by Malys et al. 2014. The study does not mention how it tackles the problem raised by Flores Larsen *et al.* regarding convective heat transfer coefficients. and we found that the equations used for the convection term in the energy balance of the foliage layer are exactly the same as the ones in the GRM. Thus, there seems to be a grey area on that matter. For the purpose of this study, we decided to take DB recommendations into account and to opt for different convective heat transfer coefficients as we elaborate below in Section 2.3.

Another challenge using this module to abstract a green façade is the presence of the soil layer. Indeed, it would not be “possible to simulate the solar radiation transmitted by the green facade” (Flores Larsen et al. 2014, 1765) to the underlying wall. Moreover, it would also block the radiative heat transfer between the foliage and the wall. Changing the material properties of this layer to suit our needs would not completely solve the problem as we will address later in the paper.

Furthermore, the green roof material cannot be applied to a window in DB because this modelling option is not available when changing the glazing model data. This means that we cannot model a green façade which is placed in front of both opaque walls and glazed surfaces.

Finally, this material cannot be used on two surfaces simultaneously. For example, if we want to model both a green roof and another vegetated surface on the building, we need to find another modelling option. Authors needing to model both a green roof and a living wall in EP reported that they added a water vapor, a soil and air layer on the wall to mimic the behavior of the vegetated surface (Pastore et al. 2017). But such a method requires strong assumptions on the effect of ET and air penetration.

b-Window Shade:

Another approach to model a green wall would be to use a window shade component. Design Builder/EnergyPlus provides ‘window blinds’ objects such as slats or shades that can be applied internally or externally. The user has to input shade thickness, conductivity and optical properties as well as openings parameters. This strategy is particularly interesting to model the air gap between the foliage and the wall because the software solves the gap airflow and temperature. Moreover, defining the properties of the openings and air permeability of the shade could be of used when trying to model the potential wind barrier effect of the plant covering. Thus this model accounts for convective heat transfer and buoyancy effect behind the foliage.

Radiative heat transfers between the shade, the underlying window and the surroundings are also properly accounted for. However, this model has two main drawbacks. First, it is an “only shading” model so evapotranspiration of the plant layer would not be simulated. In addition, in DB, it was designed to be applied to a window only and not to other opaque surfaces. We could manipulate the software and change the glazing R-value to that of the opaque wall but the implications of this strategy require further investigation.

c-Exterior Naturally Vented Cavity:

This exterior cavity acts as a radiation and convection baffle situated between the exterior environment and the outside face of the underlying heat transfer surface. (Engineering Reference, 168)

This model is similar to the window shading device in that the software solves the cavity heat balance. Plus, it can be applied in front of a whole façade (with and without openings) as it was intended to model a double skin ventilated façade. But contrary to the window shade, no solar radiation is transmitted to the underlying surface even if the baffle has openings for ventilation. Thus, EP makes the strong assumption that the baffle is just a “sun collector”. Thus, we could say that it is an “convection only” model with respect to what we want to achieve.

d-Component Block:

In DB, a component block is an object that can be used at building or site level to provide shade. It is characterized by a transmittance schedule, maximum transmittance and geometry. It is a very easy and flexible option: it can be applied anywhere around the building and the user has more freedom than in the previous options to determine the geometry. However, it is an only shading model. Indeed,

Component blocks do not absorb or conduct heat in any way - their only effect on building surfaces in simulations is related to the shading and reflection of short-wave solar radiation and light. (DesignBuilder Help File).

They are not considered in the thermal makeup of the building so the only way they affect the boundary conditions of the façades is by blocking or transmitting solar radiation. Neither convection nor evapotranspiration are accounted for.

Ideally, the new green façade model would be inspired by the correlations and inputs used in these modules.

The first three built-in models are the most promising. They have all the components we need for our model:

- the GRM is the only one in EnergyPlus that includes the evapotranspiration correlations and plant specific inputs (LAI, minimum stomatal resistance). It also provides correlations for air temperature within the foliage.
- the window shade has a good model for convection and buoyancy in the air gap and transmittance inputs to account for solar radiation hitting to the window.
- the baffle has a good convection model for the air gap as well and it can be applied to a whole façade (not only a window).

Table 1: Summary of the ideal improvements for each reviewed module.

Name in DB	Green Roof	Window Shade	Baffle	Component Block
Path in DB	Materials dialog → Green roof tab	Openings tab → window blinds dialog → shade	Construction tab → Construction header	Construction tab → Construction header
Group in EP	Surface Construction Elements		Advanced Surface Concept	Thermal Zone Description/Geometry
Name in EP	Material:Roof Vegetation	WindowMaterial:Shade	SurfaceProperty: ExteriorNatural VentedCavity	Shading:Site, Shading:Building
Improvements	-Apply it vertically (already done by Kalani et al. 2017) -Allow the user to remove the soil layer -Allow the user to add an air gap -Allow the user to apply it on a window	- ET (abstracted by Flores Larsen et al. 2015 with preliminary calculations and modifying key inputs: solar transmittance, solar absorptance, emissivity) -Derive LAI from geometry -Apply it to a non glazed surface	- ET -Transmitted solar radiation to the underlying façade -Derive LAI from geometry	-ET - Radiative heat exchange - Convective heat transfer (abstracted by Flores Larsen et al. with preliminary calculations and overriding convective heat transfer coefficient) - Derive LAI from transmittance

2.2. Challenges

In DesignBuilder, the modules or modelling options/objects rely on models coded with mathematical equations in EnergyPlus. In order to modify existing models (Figure 3) in EnergyPlus and eventually create our own green wall model, we face two challenges: replacing current equations with the right correlations and remaining consistent with the existing in-built EnergyPlus models. To find the right correlations, we focused on the equations used in the literature review for latent heat flux (evapotranspiration) and sensible heat flux (especially convection). Throughout the review, short-wave and long-wave radiation terms were mostly the same. Moreover, except for Susorova et al. 2013 and the GRM, all the studies which developed some sort of model referred explicitly to the Penman-Monteith equations to estimate evapotranspiration. We noticed differences in the sensible heat flux term or on the convection coefficients. For example, in the GRM, the sensible heat balance of the foliage layer seems to feature only momentum transport. There seem to be no exterior convective heat transfer coefficient whereas all the other models use it explicitly. These coefficients differ depending on the correlations chosen by the authors to calculate them.

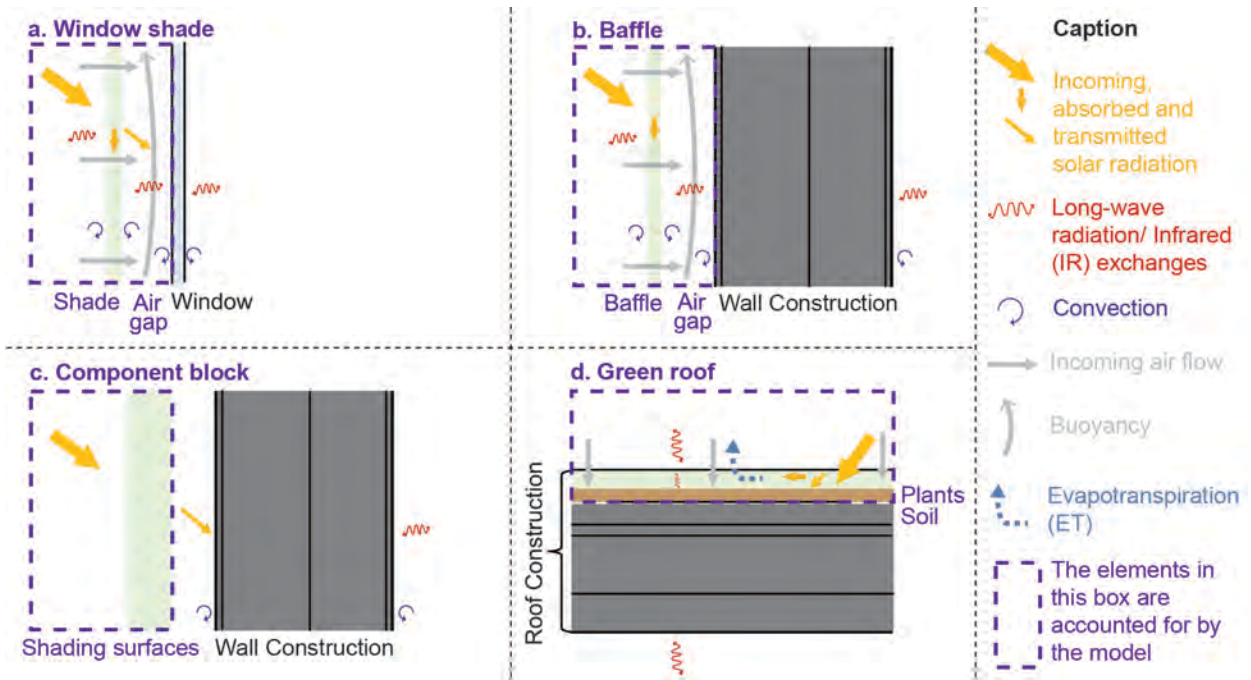

Figure 3: Model representation of four different components available in DB/EP. Components a. and b. are coupled with the underlying surface. Component c.: the model is not part of the thermal makeup of the building, it only blocks solar radiation. Component d.: the model is part of the heat transfer surface.

The second challenge refers to the fact that each available model in EP/DB has its own architecture and affects the boundary condition of the underlying wall/window outside surface in a different way. This underlying wall or window surface is considered as our base surface for heat transfer. Figure 3 a. and b. show that the program couples the window shade and the baffle with the underlying surface. On the other hand, component blocks (figure 3.c.) are detached from the wall. Finally, in the green roof model (figure 3.d.) has another configuration where the soil and vegetation layers are part of the heat transfer surface. So we need to be very careful with the outputs given by the models because they will be the new boundary condition for the underlying heat transfer surface.

2.3. Green roof model to Green Façade Model

Because we want to account for the cooling ability deriving from evapotranspiration in our model, we chose to start working with the GRM despite the limitations and challenges discussed in section 2.1 et 2.2. Indeed, the GRM already provides imbedded equations for evapotranspiration based on specific plant related inputs (LAI, stomatal resistance, etc.).

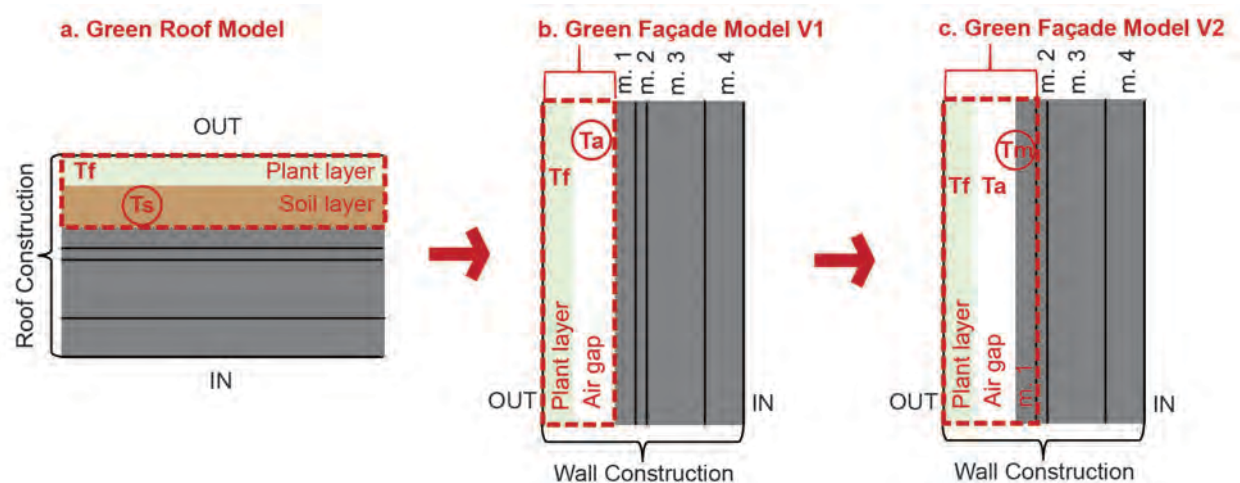

Figure 4: Building the Green Façade Model based on the green roof model. T_f , T_s , T_a and T_m : respectively, foliage surface temperature, soil surface temperature, air gap temperature, material 1 surface temperature. The temperature which is circled is the boundary condition for the underlying heat transfer surface.

We were able to alter the GRM code by replacing the soil layer correlations with that of an air gap (Figure 2.b.). For convection inside the air gap, we used correlations proposed by Flores Larsen et al. However, the only output of the model is the air gap temperature. In this configuration, solar radiation is collected by the plant and air layer and nothing is transmitted no matter the LAI. But, as mentioned further above, we know that the heat transfer through the underlying surface will also be greatly affected by solar radiation transmitted by the foliage. So even though the code is operating the simulations, there is a doubt whether the physics at the interface between the model and the underlying wall are properly accounted for. To overcome this problem, we need to connect the underlying surface to the outdoor environment. One strategy would be to add the outermost material layer of the bare wall to the model (V1, Figure 4 b.). In other words, we move the models' interface one layer towards the inside of the building (V2, Figure 4. c.). If we look at this strategy from the GRM perspective, it is mainly a two steps process. First, we add an air gap between the foliage layer and the soil layer. This implies one more heat balance equation so three total (and as many unknowns). Then, we modify the energy balance of the soil layer with the thermal characteristics of the outermost material layer of the underlying wall. We only have to remove the moisture-related terms (latent heat flux) but we can keep the conduction term. That way, user inputs remain almost the same. As shown in Figure 4. c., This strategy would allow us to keep the same conceptual framework as the GRM because all the layers that need to be directly connected to outdoor environment (solar radiation, wind speed, air temperature) are inside the model and applied as the outermost material of the wall construction. Also, in this configuration, material temperature T_m will be the ultimate output of the model and will be used as the "outside" boundary condition for calculating the heat transfer through the remaining layers of the walls. This last step is handled by usual EP computational routines. The downside of this method is that adding one more layer implies greater changes in the equations and in the EP code.

At this point, we need to pursue this work by refining the EP code and validate it with field results. Moreover, we should explore modifying the window shade device that looks promising as well to model the green façade (section 2.1.b) Taking a step back from our global strategy, we could also develop our own model separately and try to connect it to any opaque or glazed surface. Indeed, the EP Engineering Reference mentions that:

EnergyPlus also enables importing the pre-calculated results of other heat transfer processes, such as evaporative cooling envelope. An additional heat source term defined as a surface property would enable the consideration of these processes to be imported as schedules in the exterior surface heat balance calculation in EnergyPlus. (Engineering Reference, 100).

This section is quite succinct however so following this path would require more investigation.

CONCLUSION AND DISCUSSION

In this paper, we presented the pros and cons of four different strategies to model an indirect green façade (foliage layer + air gap layer) by using available features in DesignBuilder/EnergyPlus. Evapotranspiration from the plants is the main missing feature. Only the green roof model takes this phenomenon into account. As there is no specific tool to abstract our system accurately, we started modifying the GRM code and reflected on strategies to implement our own module. To refine and solidify our method regarding the characterization of the four modelling options discussed in this paper, our future work will include standardized simulations to compare the variability of results for each module.

Trying to create our own module based on an existing tool provided by a GUI like DB allows us to think from a user perspective but this approach has its limitations. While it can be convenient not to start from scratch, any modification can make the original model collapse because it was designed for one specific purpose. Also, it is challenging to see if the alterations still allow a good representations of the underlying physics. That is why validation is crucial and will be conducted in the next steps of this work. Indeed, while modifying the code with other equations is technically possible, the accuracy of the model can only be proven through a thorough validation process. We have surface temperature and heat flux data at our disposal from a summer 2020 measurement campaign (Fagbule et al. 2021) and more are currently collected from summer 2021.

One important motivation behind building this model was to account for evapotranspiration of plants in the context of building energy models. The ability of a plant to cool itself through transpiration, and thus lower its leaf temperature, is one of the major differences compared with any other shading system. However, it is important to bear in mind that this leaf temperature can vary depending on weather conditions (wind speeds, air temperature, relative humidity). Indeed, in hot and humid climates, humidity levels slow the evaporation of water from the leaves so their surface temperature is often above ambient air temperature (Passe et al. 2019). The type of plants (stomatal resistance) and LAI are also important parameters of influence for determining ET rates. For example, we can assume that for low LAI and fractional coverage, the main measurable cooling effect will come from shading rather than ET. In fact, some argue that green façade systems are called a "sunscreen" since its effect is mainly radiative" (Malys et al. 2014, 187). However, we note that Susorova et al. did take ET into account to model climbing plants such as ivy where fractional foliage coverage was probably more significant than LAI (between 0,25 to 1.5). In any case, whether it is through shading or ET, we have good reasons to think that Leaf Area Index is a critical parameter for the performance of an indirect green façade. EP green roof model sensitivity tests conducted with typical weather data for Houston and Chicago already showed that increasing the LAI value from 1 to 5 led to less electricity consumption in the summer in both cities (Sailor 2008). This discussion brings us to the following questions: what is the threshold at which ET can be negligible? Is there a point where a green covering is equivalent to a regular shading device for cooling? Answering these questions can

have an important impact on the assumptions and simplifications that can be made to abstract the green façade. This is especially important to help a designer develop a modelling and simulation strategy when no specific tool is readily available in a GUI such as DesignBuilder.

The improvement to the green wall modeling tools by refining the mathematical models and incorporation into energy building simulation software meets the need of the architecture and urban design professionals in their quest to improve urban resilience and reduce the warming of inner cities. The improved tools will enable the inclusion of those vegetative cooling strategies as green infrastructure techniques into their design. Also, community decision makers are eager to include vegetation in their cities in all sorts of ways (trees, green walls and roofs) to mitigate adverse effects of a changing climate. Providing the right tools to support stakeholder targeting the most vulnerable neighborhoods and to build relevant retrofit scenarios using vegetation-based solutions is central to resilient city developments.

ACKNOWLEDGEMENTS

The authors thank Boshun Gao, PhD and Prof. Baskar Ganapathysubramanian for detailed support with the EnergyPlus code analysis. This work is supported by the National Science Foundation, Award # 1855902. Any opinions, findings, and conclusions or recommendations expressed in this material are those of the author(s) and do not necessarily reflect the views of the National Science Foundation.

REFERENCES

- Allen, R., Pereira, L., Raes, D., and Smith, M. 1998. *Crop evapotranspiration guidelines for computing crop requirements*. FAO Irrig. Drain. Report modeling and application. Journal of Hydrology. Volume 285. 19-40.
- Assimakopoulos, M.-N., De Masi, R.F., de Rossi, F., Papadaki, D. and Ruggiero, S. 2020. *Green Wall Design Approach Towards Energy Performance and Indoor Comfort Improvement: A Case Study in Athens*. Sustainability, Volume 12. <https://doi.org/10.3390/su12093772>
- de Castro, F. and Fetcher, N. 1999. *The effect of leaf clustering in the interception of light in vegetal canopies: Theoretical considerations*. Ecological Modelling, Volume 116, 125-134. [https://doi.org/10.1016/S0304-3800\(98\)00170-7](https://doi.org/10.1016/S0304-3800(98)00170-7)
- Design Builder Hel File v.7. <https://designbuilder.co.uk/helpv7.0/>
- EnergyPlus™ Version 9.2.0 Documentation.2019. *Engineering Reference*. U.S. Department of Energy
- Fagbule, O., Patel, R., Passe, U., and Thompson, J. (2021). *Utilizing a novel mobile diagnostics lab to validate the impact of vegetative wall coverings in building cooling load reduction*. Proceedings of the 8th International Building Physics Conference, August 25-27, Copenhagen, Denmark.
- Flores Larsen, S., Filippin, C. and Lesino, G. 2014. *Thermal Simulation of a Double Skin Façade with Plants*. Energy Procedia, Volume 57,1763-1772. <https://doi.org/10.1016/j.egypro.2014.10.165>.
- Flores Larsen, S., Filippin, C. and Lesino, G. 2015. *Modeling double skin green façades with traditional thermal simulation software*. Solar Energy, Volume 121, 56-67. <https://doi.org/10.1016/j.solener.2015.08.033>
- Kalani, C., Dahanayake, K.W.D. and Chow, C. L. 2017. *Studying the potential of energy saving through vertical greenery systems using EnergyPlus simulation program*. Energy and Buildings, Volume 138, 47-59. <https://doi.org/10.1016/j.enbuild.2016.12.002>
- Katul, G., Oren, R., Manzoni, S., Higgins, C. and Parlange, M. 2012. *Evapotranspiration: A Process Driving Mass Transport and Energy Exchange in the Soil-Plant-Atmosphere-Climate System*. Reviews of Geophysics, Volume 50. <https://doi.org/10.1029/2011RG000366>
- Malys, L., Musy, M. and Inard, C. 2014. *A hydrothermal model to assess the impact of green walls on urban microclimate and building energy consumption*. Building and Environment, Volume 73, 187-197. <https://doi.org/10.1016/j.buildenv.2013.12.012>
- Manso, M. and Castro-Gomes, J. 2015. Green wall systems: A review of their characteristics. Renewable and Sustainable Energy Reviews, Volume 4 863-871. <https://doi.org/10.1016/j.rser.2014.07.203>
- Palermo, S. and Turco, M. 2020. *Green Wall systems: where do we stand?* IOP Conference Series: Earth and Environmental Science, Volume 410. <https://doi.org/10.1088/1755-1315/410/1/012013>
- Passe, U., Thompson, J R., Ganapathysubramanian, B., Gao, B., and Marmur, B L. 2019. *The impact of trees on passive survivability during extreme heat events in warm and humid regions*. Natural Resource Ecology and Management Conference Papers, Posters and Presentations.
- Passe, U., Dorneich, M., Krejci, C., Koupaei, D. M., Marmur, B., Shenk, L., Stonewall, J., Thompson, J., and Zhou, Y. 2020. *An urban modelling framework for climate resilience in low-resource neighbourhoods*. Buildings and Cities, Volume 1, 453-474.
- Pastore, L., Corrao, R. and Kvols Heiselberg, P. 2017. *The effects of vegetation on indoor thermal comfort: The application of a multi-scale simulation methodology on a residential neighborhood renovation case study*, Energy and Buildings, Volume 146, 1-11. <https://doi.org/10.1016/j.enbuild.2017.04.022>
- Perini, K., Ottelé, M., Fraaij, A. L. A., Haas, E. M., and Raiteri, R. 2011. *Vertical greening systems and the effect on air flow and temperature on the building envelope*. Building and Environment, Volume 46, 2287-2294. <https://doi.org/10.1016/j.buildenv.2011.05.009>
- Prieto, A., Knaack, U., Auer, T. and Klein, T. 2018. *Passive cooling & climate responsive façade design: Exploring the limits of passive cooling strategies to improve the performance of commercial buildings in warm climates*, Energy and Buildings, Volume 175, 30-47. <https://doi.org/10.1016/j.enbuild.2018.06.016>
- Sailor, D.J. 2008. *A green roof model for building energy simulation programs*. Energy and Buildings, Volume 40, 1466-1478. <https://doi.org/10.1016/j.enbuild.2008.02.001>
- Susorova, I., Angulo, M., Bahrami, P. and Stephens, B. 2013, A model of vegetated exterior facades for evaluation of wall thermal performance. Building and Environment, Volume 67, 1-13. <https://doi.org/10.1016/j.buildenv.2013.04.027>
- Yoshimi, J. and Altan, H. 2011. *Thermal simulations on the effects of vegetated walls on indoor building environments*. Proceedings of Building Simulation 2011: 12th Conference of International Building Performance Simulation Association. 1438-1443.

An interactive GIS-based method to map feasible roof areas for PV panels

Sedigheh Ghiasi¹, Ulrike Passe¹, Yuyu Zhou¹

¹Iowa State University, Ames, IA

ABSTRACT: Multiple platforms, software, and tools exist to support homeowners assess the feasibility of installing photovoltaic (PV) panels on their homes. However, the current platforms are not very user-friendly and often neglect the shading effect of nearby trees or other obstacles on the efficiency of the PV panels. This study presents a GIS-based method for considering the shading effect to identify suitable roof areas for hosting PV panels. Furthermore, this study estimates potential electricity output for three representative days based on the suitable rooftop area. Although currently available tools can calculate the shading effect, these tools often require excessive training and knowledge to understand and use and might deter homeowners from installing rooftop PV systems. The approach in the presented study is user-friendly and interactive. The users can enter their home address on a map and graphically view the best location of PV panels on their roofs. Also, they can easily find whether their rooftop has enough potential to meet their daily electricity needs for three representative dates. The case study location is the Capitol East neighborhood in Des Moines, IA, USA. As the map developed in this project is based on a Python-based model, the strategy can also be transferred to other neighborhoods to assess their potential on taking advantage of solar energy. The presented results for this neighborhood showed on June 20th, 93.7% of residential buildings could meet their daily electricity demand. On April 20th, 91% of buildings in the study area had enough potential to produce the daily electricity demand of a residential building. In winter, most buildings will have to rely on electricity from the grid.

KEYWORDS: PV panels, GIS, solar energy, best placement, rooftop PV system, residential building

1. INTRODUCTION

1.1 Background

The state of Iowa, US, has a good potential for harnessing solar energy. Based on a report published by Solar Nation, "the state capital of Des Moines averages at 4.7 peak sun-hours per day throughout the year and may go above six peak sun-hours during June and July" (Solar Power in Iowa: All You Need to Know, n.d.). Therefore, residential solar power is an attractive investment to integrate renewable energy sources into residential construction. The Iowa Environmental Council mentioned: "Iowa ranks 16th in the technical potential for solar photovoltaic (PV) energy generation. It can provide 4000 gigawatts (GW) of solar energy, 150 times more than the annual requirements of Iowa" ("Solar Energy - Iowa Environmental Council", n.d.).

Based on ASHRAE 169-2006 standard, Des Moines's climate is classified as climate zone number 5 and climate zone subtype A, a cool- humid climate ("Climate Zone 5A | Open Energy Information", n.d.). Due to the harsh winter in Des Moines, the City's capacity to take advantage of solar energy is under question for non-expert users. This study is organized to assess the overall potential of the study area in exploiting solar energy. The foremost concept is to use Light Detection and Ranging (Lidar) data and the hillshade tool in Arc GIS Pro ("How hillshade Works—ArcGIS Pro | Documentation", n.d.) to find hourly shading coverage from all obstacles around the buildings, including trees, chimneys, and other structures in order to estimate the best location for PV panels and potential electricity output for individual rooftops.

1.2 Research Objective

This research has two objectives. Several misconceptions about the performance of rooftop solar panels exist, which might cause hesitation to install PV panels on residential rooftops (Garrett and Koontz 2008; Boamah 2020). For example, for many homeowners, where trees surround their building, it seems impossible to take advantage of solar energy on their rooftop. The first objective is to rectify these kinds of misinformation by offering guidance to non-expert users by providing an interactive map. Users would be able to easily find the best placement of PV panels on their rooftop while considering shading effects.

The second objective is to accurately visualize the shadow coverage caused by trees. Currently the expensive and time-consuming process of gathering information about trees, such as height, crown size, and species, has led researchers to simplify calculation of shading coverage. This study uses Lidar data to extract 3D information of trees

and roof geometry to map shadow coverage of trees using the hillshade tool in Arc GIS Pro-2.7.26828. By predicting shading from trees and anthropological sources during various hours for a given neighbourhood, the interactive map can help homeowners determine how much electricity their rooftop can produce through PV panels.

1.3 Study area

Capitol East, Des Moines, IA, USA, was chosen as the study area (Figure.1). Based on a report published by the Iowa State University Planning Team, "the median household income in Capitol East is \$20,803, which is less than half that of the City of Des Moines; and, the median household size in Capitol East is slightly larger than that of the city overall". Therefore, Capitol East is a low-income neighborhood and a good target for energy-saving programs. Des Moines offers good potential (Alcivar et al., 2014) for taking advantage of solar energy. The peak sun hours in Des Moines for fixed-tilt non-tracking solar panels is 4.8 hours per day, for 1-Axis tracking solar panels is 6.2 hours per day, and for 2-Axis tracking solar panels is 6.4 hours per day (Solar Power Information & Peak Sun Hours in Des Moines 2021).



Figure 1- The study area of Capitol East, Des Moines, Iowa, USA. Source: Author

1.4 Literature review

The rapid adoption of residential, commercial, and industrial PV systems is changing the roles of electricity producers. The inclination toward solar energy needs teamwork, including policymakers, decision-makers, designers, and even individual homeowners ("Renewable Power – Analysis - IEA", n.d.). The U.S. Department of Energy Solar Decathlon is an academic level competition as an example of a worldwide effort to encourage students to join the clean energy workforce, in which all the minds come together to promote clean energy in a teamwork effort ("Solar Decathlon", n.d.). "In the U.S., home installations of solar panels have fully rebounded from the COVID slump, with analysts predicting more than 19 gigawatts of total capacity installed, compared to 13 gigawatts at the close of 2019" ("The Dark Side of Solar Power", n.d.). One of the goals for the Solar Energy Technology Office at the Department of Energy (DOE) is to decrease the cost of solar (PV) to \$0.02 and \$0.05 per kilowatt-hour without subsidies for utility and residential scales respectively, by 2030 ("Solar Energy Technologies Office Updated Solar Energy Technologies Office Updated 2030 Goals for Utility-Scale Photovoltaics | Department of Energy", 2021). To accelerate rooftop PV systems adoption, many studies focused on solar energy from a variety of perspectives and aspects. This chapter will review the studies related to improving the placement of rooftop PV on residential buildings.

During the last decades, Lidar data had a significant role in solar energy production as a remote sensing method for optimizing the performance of PV systems. This literature review focuses on the role of Lidar data and the hillshade tool in assessing solar energy utilization. Many studies used Lidar data to estimate the technical potential of rooftop PV panels (Gagnon et al. 2018; Hong et al. 2016; 2013; Brandt 2014). The main role of Lidar data was modeling slope, tilt, and aspect of rooftops. Various products of Lidar data, such as a digital surface model (DSM), digital elevation model

(DEM), and digital terrain model (DTM), were used to present a 3D model of particular study areas. Depending on the purpose of the study, the selection of the elevation model can vary.

Bergamasco et al. (2011) presented a GIS-based method and solar radiation map to estimate the efficiency of rooftop PV panels for Piedmont buildings in north-western Italy. They used a digital elevation model (DEM) to calculate the shadow effect from other buildings or trees. Their results showed that rooftop PV systems could effectively provide electricity for the selected buildings. They analyzed solar energy exploitation scenarios such as geographical and physical potential. Based on the best scenario, solar energy potential reached 6.9 TWh for the examined year.

Jung et al. (2021) used a GIS-based machine learning method to optimize the planning of rooftop PV systems. They included the uncertainty of future scenarios in the life cycle of buildings. The role of GIS analysis in this research was to set up the spatial data for the rooftop PV installation. The central core of this study was to develop a GIS-based reinforcement learning (LR) to assess the economic profitability of rooftop PV systems and boost the financial feasibility of rooftop PV systems for buildings. They used a DSM model to create a solar radiation map for the study area. Based on the outcome of the mentioned studies, this study presented here, is using this DSM model to map solar radiation and shadow coverage for the current research.

The efficiency of PV systems can drop due to shading from obstacles around the PV panels. Shading of one cell of 36 cells in a small PV panel can drop power output by 75 % (“Shading Losses in PV Systems, and Techniques to Mitigate Them - Aurora Solar” , 2021). Using the hillshade effect in Arc GIS Pro allows for the visualization of the shadow coverage from obstacles around each building. This is supported by multiple studies (Hong et al. 2016; Jung et al. 2021; Hong et al. 2017; Ko et al. 2015). The Environmental Systems Research Institute (Esri) (“GIS Mapping Software, Location Intelligence & Spatial Analytics | Esri”, n.d.) concluded that the hillshade tool could effectively calculate shading coverage.

Yu et al. (2020) conducted research to investigate the cooling effect of trees in mitigating the urban heat island (UHI) effect. They used the hillshade function in a geographic information system (GIS) to assess the spatiotemporal patterns of trees. Among all their findings, they found that the hillshade function can accurately capture the spatial and temporal variation of tree shading. Due to the success of the previously mentioned studies, the hillshade tool is a reliable option for visualizing shading coverage.

In the presented study, total hourly solar radiation in watt-hours per square meter was calculated for buildings' polygons using the Area Solar Radiation tool (Spatial Analyst) in Arc GIS Pro. This tool derives insolation from a DSM model. Similar to the current research, Bunme et al. (2021) used the Area Solar Radiation function in Arc GIS Pro to map solar radiation. The simulation was conducted for April 19th from 12 pm to 12:30 pm. In this study, a DSM model was the basis to consider the shading of surrounding objects such as trees. Bunme et al. conducted the analysis just for one-half hour. As that timeframe is not sufficient for a daily analysis, the current study analyzed the full number of sunshine hours.

2. METHODOLOGY

The primary purpose of this study was to develop a GIS-based method to determine the best placement of PV panels while considering the shading effect of trees. The workflow designed to address the main question of the research is visualized in figure 2.

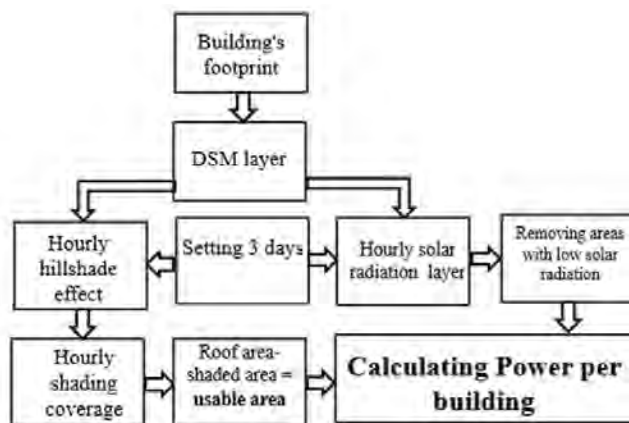

Figure 2-Workflow of research, using GIS data to determine the feasible area for rooftop PV panels installation

2.1. Buildings' footprint

A 2-D map of the neighborhood was created based on the buildings' footprint received from the Des Moines Assessor office ("Polk County Assessor Des Moines Residence Inventory Query" n.d.; "City of Des Moines GIS Data City of Des Moines GIS Data", n.d.). The building data were provided in a shapefile (.shp) format as polygon data (vector data), which contained the building data as an attribute table. The attribute table included: the buildings' footprint, elevations, material characteristics, thermal conditioning systems (HVAC).

2.2. Determining the study period

The first step to calculate shading coverage and solar radiation was to set a day and time. In this study, three specific days were chosen. The first day is summer solstice, June 20th, as the longest day in a year ("Sunrise and Sunset Times in Des Moines, June 2021", n.d.). The second day is the winter solstice, December 20th. This day was chosen because it is the shortest day ("Sunrise and Sunset Times in Des Moines, December 2021", n.d.). Finally, April 20th was selected because this day has a median length of sunny hours in a year ("Average Monthly Hours of Sunshine in West Des Moines (Iowa), United States of America", n.d.).

2.3. Mapping solar potential

Area Solar Radiation ("Area Solar Radiation (Spatial Analyst)—ArcGIS Pro | Documentation", 2021) is a tool in Arc GIS Pro which can calculate insolation. Using the mentioned tool, the total hourly solar radiation for each building was calculated in watt-hours per square meter. This tool derives insolation from a digital surface model (DSM). As this tool is operating based on latitude of the study area, it can be used only for a small area in the scale of a neighborhood. For the larger scales such as states and counties, dividing the study area into zones for each latitude is required. The output will reveal the total incoming direct and diffused solar radiation per square meter in watt-hours (Wh/m²) for each time step. The minimum solar radiation to operate a PV panel for electricity production lies in the range of 100 to 200 W/m², which is sufficient to operate one light fixture and a fan. Based on the conservative approach of this study, the highest value was taken as the minimum solar radiation, and areas that received solar radiation less than 200 W/m² per hour were removed.

2.4. Calculating usable area

Usable areas in this research will be defined as the locations on the rooftop of each building that are never covered by full shadow. In this study, the shaded area is subtracted from the whole roof area to calculate the usable area. The total amount of insolation received per hour by each building was calculated by multiplying each building's usable area by its mean solar radiation. In the end, by dividing the results by 1000, the result was converted to kWh/m².

Equation [1]- Solar radiation received by each rooftop (kWh/m²)

$$TR = (a * M) / 1000$$

TR=The total amount of solar radiation received by each rooftop

a=usable area

M=mean solar radiation received to each spot on the roof

2.5. Converting solar radiation to potential electrical power output

The next target is converting the solar radiation received by the roof to potential electricity output using a formula suggested by D. Khanna ("Estimate Solar Power Potential | Learn ArcGIS", n.d.).

Equation [2] -Hourly electricity production in each rooftop

$$Elec_h = TR * 0.15 * 0.86$$

Elec_h = electricity production in each hour(kWh)

TR=The total amount of solar radiation received by each rooftop (kWh)

The source for the two factors is The United States Environmental Protection Agency (EPA). This agency estimated that solar panels could convert 15 percent of incoming solar radiation to electricity, and 86 percent of the produced electricity is retained by the installation.

2.6. Mapping solar energy and hourly hillshade effect

Hillshade is a technique in Arc GIS Pro to create a stunning 3-D representation of above ground features. To create this effect, we can use either DSM or DEM model. Aside from creating a 3-D model of the map, the hillshade tool creates a shaded relief raster based on an elevation raster (digital surface model or digital elevation model). Hillshade presents a grayscale raster, cells with zero value represent cells that are in full shade, and cells coded with integer values from 1 to 255 indicate the cells with various levels of shading (How hillshade Works—ArcGIS Pro | Documentation, n.d.). In this research, we used the hillshade effect to create an hourly shadow probability map. In a shadow raster, fully shaded cells have a zero value. The values were converted to a binary raster to picture shadow footprints on rooftops. By multiplying the solar radiation raster and the binary raster, the cells that were under the shadow in the binary raster received zero value in the solar radiation raster. Then, all the shadow coverages were added up to present a daily shadow coverage. The daily shadow map shows spots on the roof that were not covered by shadow during sun hours. The outcome of this step was then used for calculating usable area.

3. RESULTS

The following results are based on DSM data provided by the City of Des Moines (“City of Des Moines GIS Data City of Des Moines GIS Data” ,n.d.). In this study, only residential buildings were included to investigate the solar capacity of those properties. As the map's scale is large, the results will be presented in micro-scale and macro-scale analyses. Micro-scale analysis narrows the map down to a small part of the study area, such as an individual building, to present the final map in high resolution.

3.1. Micro-scale analysis results

A number is assigned to each building. The hourly shadow footprint and solar radiation intensity for one of the buildings building 859 will be presented in this chapter. This building was chosen because surrounding trees partially shade the roof. Although the analysis was conducted for each hour, only three hours are included in this chapter as a representative for the morning, mid-day, and afternoon. Figures 3-5 show shadow coverage at 9 am, 12 pm, and 3 pm, and solar radiation for the same hours for June 20th.

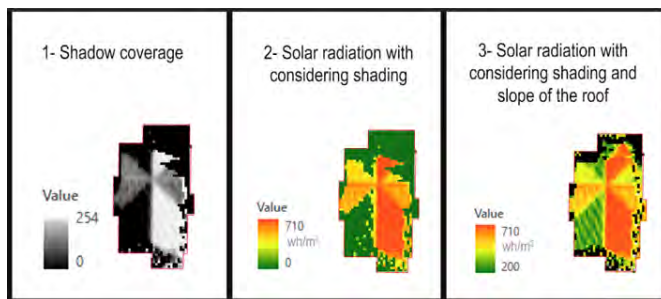

Figure 3- Solar analysis for 20 June, at 9 am, Source: author

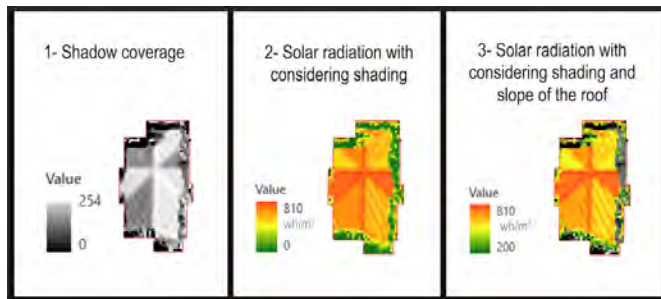

Figure 4- Solar analysis for 20 June, at 12 pm, Source: author

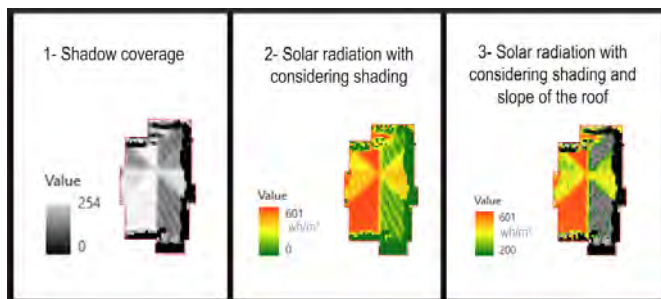

Figure 5- Solar analysis for 20 June, at 3 pm, Source: author

In figures 3 - 5, the first image of each figure indicates shadow coverage. Areas with zero value show those areas that were completely covered by shadow. The second image shows solar radiation received by the rooftop. Locations with zero value indicate that those areas did not receive solar radiation because they were under the shadow of surrounding obstacles. Lastly, the third image was produced by combining the previous two images and indicating areas that received solar radiation more than 200 W/m² for each hour. Thus, the third image in each figure shows the best locations for PV panel installation. Finally, potential electricity production was calculated for each building. The average energy consumption (electricity usage) per home in Iowa is around 30 kWh/day (“Des Moines, IA Electricity Rates | Electricity Local”, n.d.), in which heating is excluded. Table 1 shows the potential daily electricity production in the three selected days for building 859. It is worth mentioning that we assumed PV panels covered all the suitable areas. Then, electricity production is calculated for the usable area completely covered by PV panels.

Table 1- Daily electricity production for building 859, source: Author

Daily electricity production- Building 859 (kWh)			Average electricity needs of a residential building in Iowa
20 June	20 April	20 December	
671	464	0	30 kWh per day

3.2. Macro scale analysis results

The purpose of including macro analysis is to show the overall potential of the neighborhood. The legend of the map changes from green to red. The red areas show areas with high potential, and green indicates areas with low potential in taking advantage of solar panels. As the neighborhood is in red (Fig.6), there is a remarkable capacity to exploit solar energy in the study area. Low potential areas are not the best place but are acceptable places and can be an option for PV systems placement, if the homeowners or designers need more areas on the rooftop.

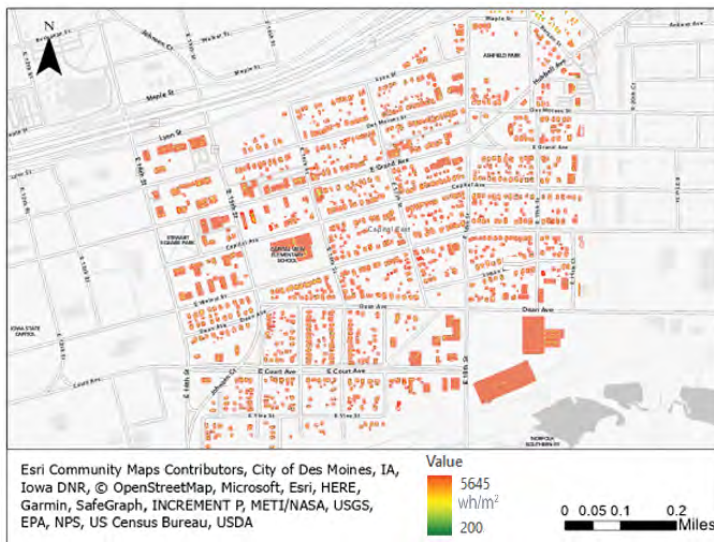

Figure 6- Overall solar potential of the study area on June 20th

Based on the results, many of the buildings can meet a residential building's electricity demand in June and April. Some of the buildings in the study area are not residential buildings. Therefore, their daily electricity need would be more or less than 30 kWh per day. In December, there is no chance to take advantage of solar energy for any of the buildings. Table 2 shows the number of buildings that can meet average electricity need of a residential building on the noted dates.

Table 2- The number of buildings that can meet average residential electricity need on the specific dates in the study area. Source: Author

Number of buildings can produce their daily electricity demand		
20 June	20 April	20 December
1213	1185	0

Many factors contribute to a roof's suitability for PV systems. While a factor such as orientation may qualify a roof as a good location for PV panel installation, other factors can decrease the efficiency of PV panels on that rooftop, such as shading effects. Thus, orientation cannot be the only decisive factor for qualifying a rooftop for installing PV panels. A set of other factors should be considered in estimating the efficiency of rooftop PV systems. As mentioned in the literature review, extraction of roof geometry based on Lidar data has been used in multiple other research studies. Similarly, in this study, the effect of orientation and tilt angle of roofs were considered in our methodology by using a DSM model. As shown in figure 7, the rooftop areas facing south receive more solar energy than the areas facing north. This indicates that the DSM model correctly extracted each part of the roof. After mapping solar energy based on the DSM model, areas that received solar radiation less than 200 W/m² were removed. By doing so, we indirectly considered the effect of the direction of roofs. Our strategy for finding the best placement of rooftop PV panels was

based on the shading effect, the amount of solar radiation, and roof direction. We did not remove areas only based on their direction. Our criterion for omitting some areas on rooftops was the amount of solar radiation received by those areas. If some areas received insufficient solar energy, it could be due to only one reason or a combination of multiple reasons. To prove the latter, figure 7 shows our methodology does not suggest some areas facing south as the best placement for PV systems installation due to the fact that they are covered by shadow.

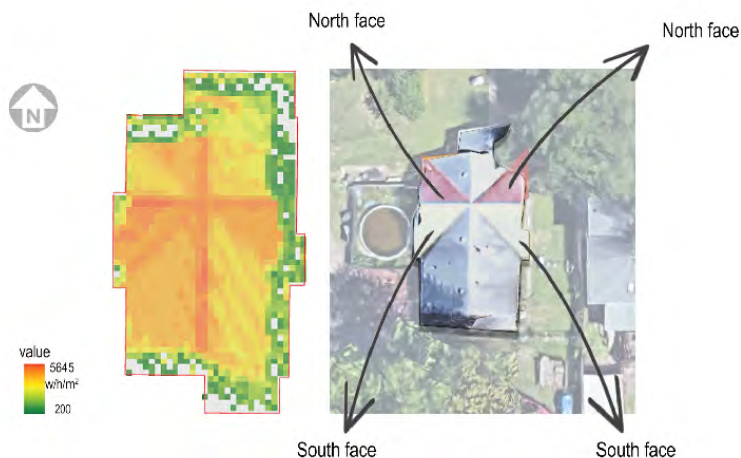

Figure 7- Modelling roofs based on DSM model, source: author

4. DISCUSSION

This study aims to develop a GIS-based methodology to determine the best placement of rooftop PV panels using Arc GIS Pro, hillshade tool, and Lidar data. Reproducibility is one of the other benefits of the presented methodology. The algorithm is developed in Python which allows the conversion to a reproducible model for other locations. Thus, developing similar research applications for another neighborhood would only need preparation of a 2D map in Arc GIS Pro as an input for the method presented herein. Different groups such as policymakers, and utility companies can benefit from the presented study. The interactive map can help policymakers to customize their policies based on the solar potential of each neighborhood. For example, breaking down the tax, giving away free parking pass in the public areas for homeowners are a few examples of policies that can encourage homeowners to think about the value of equipping their roof with PV systems. Utility companies are another group that can take advantage of this study by targeting high potential rooftops. For homeowners who cannot afford the initial costs of PV systems, leasing a rooftop to the utility companies would become an option. Both utility companies and homeowners can benefit from such strategy and decrease the carbon footprint of the neighborhood. By doing so, although homeowners are not paying for PV panels installation, they can have a role in shaping a sustainable neighborhood. Although this methodology is developed in a complex way to find the best placement of rooftops for each building, the final result is a user-friendly interactive map for non-expert users. The users can enter their home address in the link below and see the best location of PV panels on their rooftop. This link is available only for Arc GIS users. <https://arcg.is/XLjXH>

5. CONCLUSION

The primary motivation of this research was the need for a technology that can offer guidance to non-expert users to easily find the best placement of PV panels while considering shading effects. A secondary motivation was the desire of homeowners to have the ability to estimate energy saving due to the installation of PV panels on their own. The methodology presented in this study was able to accurately calculate shading effect of trees. Although trees shades decrease the efficiency of PV systems, they have many other benefits for thermal comfort on both the building and urban level. Different scenarios can help to find a trade-off between trees and PV systems. The strategy presented in this study allows homeowners to keep the trees and calculate solar radiation received by the rooftop while considering the shadow effect. The current research assumes trees with leaves as a solid shadow object, while leaves density varies based on the season and geographical location. Future work will need to consider an impact factor for tree leaves density.

6. ACKNOWLEDGMENT

This work was partially supported by the National Science Foundation, Award # 1855902. Any opinions, findings, and conclusions or recommendations expressed in this material are those of the author(s) and do not necessarily reflect the views of the National Science Foundation.

REFERENCES

- Alcivar, Johnny, Jane Rongerude, Anna Blumstein, Katherine Dostart, Joseph Drahos, Lydia Levinson, Julia Whitson, and Xianli Zeng. 2014. "Capitol East Neighborhood Charter Plan Update." Iowa State University, Digital Repository. January 1, 2014. <https://dr.lib.iastate.edu/handle/20.500.12876/63027>.
- "Area Solar Radiation (Spatial Analyst)—ArcGIS pro | Documentation." n.d. Pro.arcgis.com. Accessed January 17, 2022. <https://pro.arcgis.com/en/pro-app/latest/tool-reference/spatial-analyst/area-solar-radiation.htm>.
- "Average Monthly Hours of Sunshine in West Des Moines (Iowa), United States of America." n.d. Accessed September 7, 2021. <https://weather-and-climate.com/average-monthly-hours-sunshine,west-des-moines-iowa-us,United-States-of-America>.
- Bergamasco, Luca, and Pietro Asinari. 2011. "Scalable Methodology for the Photovoltaic Solar Energy Potential Assessment Based on Available Roof Surface Area: Application to Piedmont Region (Italy)." *Solar Energy* 85 (5): 1041–55. <https://doi.org/10.1016/j.solener.2011.02.022>.
- Boamah, Festus. "Desirable or debatable? Putting Africa's decentralised solar energy futures in context." *Energy Research & Social Science* 62 (2020): 101390.
- Brandt, David. "Rooftop solar capacity modeling using GIS within the city of Stillwater, MN." PhD diss., 2014.
- Bunne, Pawita, Shuhei Yamamoto, Atsushi Shiota, and Yasunori Mitani. "GIS-Based Distribution System Planning for New PV Installations." *Energies* 14, no. 13 (2021): 3790.
- "City of Des Moines GIS Data City of Des Moines GIS Data." n.d. Accessed July 19, 2021. https://www.dsm.city/city_of_des_moines_gis_data/index.php.
- "Climate Zone 5A | Open Energy Information." n.d. Accessed August 25, 2021. https://openei.org/wiki/Climate_Zone_5A.
- "Des Moines, IA Electricity Rates | Electricity Local." n.d. Accessed January 13, 2022. <https://www.electricitylocal.com/states/iowa/des-moines/>.
- "Estimate Solar Power Potential | Learn ArcGIS." n.d. Accessed August 6, 2021. <https://learn.arcgis.com/en/projects/estimate-solar-power-potential/>.
- Gagnon, Pieter, Robert Margolis, Jennifer Melius, Caleb Phillips, and Ryan Elmore. "Estimating rooftop solar technical potential across the US using a combination of GIS-based methods, lidar data, and statistical modeling." *Environmental Research Letters* 13, no. 2 (2018): 024027.
- Garrett, Vicki, and Tomas M. Koontz. "Breaking the cycle: Producer and consumer perspectives on the non-adoption of passive solar housing in the US." *Energy Policy* 36, no. 4 (2008): 1551-1566.
- "GIS Mapping Software, Location Intelligence & Spatial Analytics | Esri." n.d. Accessed November 15, 2021. <https://www.esri.com/en-us/home>.
- Hong, Taehoon, Choongwan Koo, Joonho Park, and Hyo Seon Park. "A GIS (geographic information system)-based optimization model for estimating the electricity generation of the rooftop PV (photovoltaic) system." *Energy* 65 (2014): 190-199.
- Hong, Taehoon, Minhyun Lee, Choongwan Koo, Kwangbok Jeong, and Jimin Kim. "Development of a method for estimating the rooftop solar photovoltaic (PV) potential by analyzing the available rooftop area using Hillshade analysis." *Applied Energy* 194 (2017): 320-332.
- Hong, Taehoon, Minhyun Lee, Choongwan Koo, Jimin Kim, and Kwangbok Jeong. "Estimation of the available rooftop area for installing the rooftop solar photovoltaic (PV) system by analyzing the building shadow using Hillshade analysis." *Energy Procedia* 88 (2016): 408-413.
- "How HillShade Works—ArcGIS Pro | Documentation." n.d. Accessed July 20, 2021. <https://pro.arcgis.com/en/pro-app/latest/tool-reference/3d-analyst/how-hillshade-works.htm>.
- Jung, Seunghoon, Jaewon Jeoung, Hyuna Kang, and Taehoon Hong. "Optimal planning of a rooftop PV system using GIS-based reinforcement learning." *Applied Energy* 298 (2021): 117239.
- Ko, Li, Jen-Chun Wang, Chia-Yon Chen, and Hsing-Yeh Tsai. "Evaluation of the development potential of rooftop solar photovoltaic in Taiwan." *Renewable Energy* 76 (2015): 582-595.
- "Polk County Assessor Des Moines Residence Inventory Query." n.d. Accessed December 6, 2021. <http://web.assess.co.polk.ia.us/cgi-bin/web/tt/form.cgi?tt=rinvenformDM>.
- "Renewable Power – Analysis - IEA." n.d. Accessed November 29, 2021. <https://www.iea.org/reports/renewable-power>.
- "Shading Losses in PV Systems, and Techniques to Mitigate Them - Aurora Solar." n.d. Accessed December 6, 2021. <https://www.aurorasolar.com/blog/shading-losses-for-pv-systems-and-techniques-to-mitigate-them/>.
- "Solar Decathlon." n.d. Accessed January 15, 2022. <https://www.solardecathlon.gov/>.
- "Solar Energy - Iowa Environmental Council." n.d. Accessed September 29, 2021. <https://www.iaenvironment.org/our-work/clean-energy/solar-energy-work>.
- "Solar Energy Technologies Office Updated 2030 Goals for Utility-Scale Photovoltaics | Department of Energy." n.d. Accessed December 6, 2021. <https://www.energy.gov/eere/solar/solar-energy-technologies-office-updated-2030-goals-utility-scale-photovoltaics>.
- "Solar Power in Iowa: All You Need to Know." n.d. Accessed November 11, 2021. <https://www.solar-nation.org/iowa>.
- "Sunrise and Sunset Times in Des Moines, December 2021." n.d. Accessed September 7, 2021. <https://www.timeanddate.com/sun/usa/des-moines?month=12>.
- "Sunrise and Sunset Times in Des Moines, June 2021." n.d. Accessed July 20, 2021. <https://www.timeanddate.com/sun/usa/des-moines?month=6>.
- "The Dark Side of Solar Power." n.d. Accessed December 6, 2021. <https://hbr.org/2021/06/the-dark-side-of-solar-power>.
- "U.S. Environmental Protection Agency | US EPA." n.d. Accessed January 15, 2022. <https://www.epa.gov/>.
- Yu, Qiuyan, Wenjie Ji, Ruiliang Pu, Shawn Landry, Michael Acheampong, Jarlath O'Neil-Dunne, Zhibin Ren, and Shakhawat Hosen Tanim. "A preliminary exploration of the cooling effect of tree shade in urban landscapes." *International Journal of Applied Earth Observation and Geoinformation* 92 (2020): 102161.

Rooftop Additions: An Alternative Model of Urban Growth

Olivier Chamel¹, Bernd Dalhgruen², Laurent Lescop³

¹Florida A&M University, Tallahassee, FL

²Hafen City University, Hamburg, GERMANY

³Ecole National Supérieure d'Architecture, Nantes, FRANCE

ABSTRACT: Cities have been the physical manifestation of human progress and a place of unique opportunities in terms of welfare, social mobility and economic prosperity. As outlined in the United Nations Sustainable Development Goals and under the pressure of continued global growth, cities have become complex organisms and are facing increasing challenges. Environmental quality, transportation systems, social balance and access to affordable housing continue to be issues of great concern as they need to be balanced against economic and demographic pressure. The question of urban growth is a key issue as cities can only grow so much in a sustainable and resilient manner. In that context this paper will address a strategy of urban development based on increasing the density of existing urban centers by means of rooftop additions. In essence this concept is in keeping with the notion of urban growth as an incremental process where new building units and infrastructures are added and intertwined with existing ones. It also recognizes the value of existing urban profiles. This urban design process has been successfully implemented in Europe for a number of years in cities such as Hamburg, Germany and presents significant potential in term of urban growth. As a sign of its relevance, MVRDV just published "Rooftop Catalogue", a study about the potential of rooftop additions in the city of Rotterdam. We propose to present existing case studies of built rooftop projects as well as a collaborative design exercise undertaken by 3 schools of architecture located on 3 different continents. The students' projects investigated rooftop additions in 3 different cultural and urban contexts in Europe, the US and Africa. Overall, this innovative urban design approach is aimed at minimizing gentrification, urban sprawl and creating affordable housing in neighborhoods that are economically dynamic, socially diverse and remain attractive places to live.

KEYWORDS: Urban Densification, Affordable Housing, Rooftop Additions

INTRODUCTION

Today, half of the world's population already live in cities, with 5 billion expected by 2030. (United Nations Sustainable Development Report 2020). The many benefits of cities, especially prospects for upward social and economic mobility, are obviously driving this trend of prolonged urban growth. According to the UN Sustainable Development Goals, metropolitan areas currently account for 70% of global GDP. Cities are increasingly confronted with significant challenges as they grow into extremely large urban hubs. In fact, the larger the city, the more difficult it is to control the flow of people, vehicles, water, waste, and other resources in a long-term manner. While urban centers are unquestionably locations of great opportunity, they are also known to cause stress due to longer commute times, poor air quality, and a lack of affordable healthcare and housing. Access to affordable housing in urban areas is a particularly difficult problem to solve and residents of large cities typically live in suburbs because the cost of housing in the city is disproportionately high in comparison to their income. As a result, they spend a significant amount of time commuting to work, causing stress and a loss of productivity. In addition to financial and practical considerations, affordable housing in metropolitan areas is also important in terms of access to services, culture, and social interactions. The idea of cities as socially and economically diverse hubs is a noble objective that is not easily achieved. Rent regulation and subsidized housing are examples of mechanisms allowing low and middle-income residents to live in urban areas close to their jobs. Unfortunately, these prospects are limited due to a lack of housing supply, as the majority of new housing units are built on the outskirts of existing cities or in far-flung suburbs.

Globally, cities continue to expand as rural areas continue to lose population to urban areas. In countries with abundant and accessible land resources, such as the US, this type of growth leads to unmanageable sprawl. In countries with limited land resources and restrictive laws, such as Europe, urban growth has historically led to a strong urban densification, which culminated in the 19th century in a high-density urban form, which we call today the European city. This paper proposes to discuss an urban development strategy that continues the European tradition of densification but with new methods, namely by adding additional floors to existing buildings. This approach is grounded in the notion of urban growth as an additive process where new buildings and infrastructures are intertwined with existing ones. It recognizes the value of historical urban structures and seeks to preserve them. This urban design process has been developed and tested in Hamburg for several years and represents an original and promising approach to urban growth.

It relies on the use of lightweight construction systems, such as wooden prefab, due to their lightweight, ease of assembly and insulating value, among other reasons. This approach is complex and involves spatial planning laws, building codes, structures, building systems, social identity and architectural expression. Its overarching goal seeks to counteract the effects of gentrification and urban sprawl and provide quality affordable housing at attractive prices in desirable neighborhoods.

1. ROOFTOP ADDITIONS IN DIFFERENT CONTEXTS: HAMBURG, MAURITIUS AND THE U.S.

Today Hamburg is a city of 2 million people, which was founded in the year 800 on the banks of the Elbe, a river which flows into the North Sea. In the 19th century, Hamburg, like almost all Western European cities, experienced an explosive population growth, which was followed by an unprecedented building boom. The urban structures built during that period were similar throughout Europe and based on the use of masonry.

It is interesting that these buildings were constructed using the same technology over several centuries. Until 2015, buildings in Hamburg were only allowed to be built using masonry or concrete. In fact, until the early 1970s, all residential buildings were constructed exclusively as masonry structures for a period of more than 100 years. These structures were not structurally calculated until the end of the 1960s but followed clear rules. These specific conditions enabled us to represent the Hamburg building fabric in models and to evaluate it structurally with regards to additional loading potential for building additions. We were able to determine that the masonry wall structures of most models were statically over dimensioned, though their foundations were not. Therefore, the latter would have to be strengthened by means of injection procedures.

Hamburg has been a growing city for centuries, but it has few additional land resources and thus potential for expansion is limited. This is reflected in Hamburg's building laws. The city was allowed to incrementally increase the maximum height of its building stock. Today, the height of buildings is legally limited by the length of fire ladders and the distance between adjacent buildings. Over the years, the maximum distance to neighboring buildings has been reduced in the building codes, and today it is possible to build higher and add stories to almost any building whose levels can be reached by a fire department ladder. Today, most historical buildings within the city are eligible to receive additions. In terms of construction, the addition of rooftop units is contingent on lightweight structures using either wood or steel. These building systems along with the associated site management are significantly more expensive (approx. +50%) when compared to conventional construction. Thus, when comparing construction costs, building rooftop additions initially appears economically unrealistic. However, this approach does not take into account the cost of land, as this strategy does not require the purchase of a lot. As it is the case in almost all German cities, real estate prices have risen explosively in the last 15 years and have doubled in the last 9 years alone. Today in Hamburg, the cost of purchasing land to the square meter of apartment built is as high as the construction cost. For this reason, building rooftop additions can lead to extremely economical projects, especially in metropolitan areas.

But one can wonder about the large-scale feasibility of such projects. Can rooftop additions have the potential of creating a significant impact in terms of housing units? For example, how many apartments could be created in Hamburg with this system? Based on the research conducted in Hamburg using a GIS analysis of a 3D city model it was estimated that rooftop units would bring a building potential of 70,000 additional apartments. In the past 5 years, this form of urban development has become a focus for politicians and developers. Consequently, the Hanseatic City of Hamburg has revised obstructive urban laws and construction codes in order to facilitate the development of rooftop additions.



Figure 1: Hamburg rooftop addition. (Dalhgruen 2012)



Figure 2: Crane set-up. (Dalhgruen 2012)

The perception of rooftop additions in Mauritius is completely different. Houses are traditionally extended upwards as the family grows and floors are added to house successive generations. This creates an environment where houses possess a great formal variety and stairs, located on the perimeter of buildings become unique architectural features. It should be noted that cranes are rarely used for private residences, as houses are erected floor by floor. Cast in place concrete structures are poured on site one floor at a time. Height restrictions are driven by the maximum height to pump concrete. The roof slab is often left rough and is not insulated as the building may be extended in the future. As a result, roof slabs often leak and offer poor protection against heat gain therefore increasing cooling loads and the need to rely on air conditioning.

In Mauritius the concept of rooftop additions to either extend an existing residence or create a rental unit is accepted as part of the local culture. Even though building typologies are diverse in Mauritius and generally associated with specific social groups, the damages inflicted by past cyclones have cemented the use of concrete as a safe and reliable material of construction. Rooftop additions can be applied to a number of different building typologies. In many cases one or two-story existing residences with a flat concrete roof can extend upward. But it is not uncommon for buildings with gable roofs or light weight shed roofs to receive rooftop additions. In such cases many structural improvements are needed. Overall, additions can take many different forms and reflect an approach where buildings are never considered finished but rather in a constant state of evolution. Rooftop additions are evolving and are starting to embrace more sustainable strategies. The use of locally sourced bamboo as a lightweight building material and wrap-around porches are among some of the solutions considered to reduce heat gain, energy consumption and stimulate the local economy.



Figure 3: Rooftop study, Mauritius. (Chamel 2019)



Figure 4: Original residence. (Lescop 2019)

The overall issue of urban growth and density in the US is very different than that of European countries. As we all know. The American city has been shaped by a virtually unlimited access to land supply and the widespread development of the automobile. In that context urban centers have grown very large in size but have remained low in terms of density, which eventually lead to serious challenges. In that context and for the past 20 years, architects and urban planners I've started to explore different models of urban development where density, use, pedestrian access and public transportation play a more prominent role. The US has developed a variety of strategies to increase urban density such as revising zoning laws and codes or encouraging the construction of accessory dwelling units in suburban residential areas. The economical and practical feasibility of rooftop additions remain questionable in many cities due to the relatively low cost of land and the lightweight construction systems used in many parts of the country. Nonetheless, the increase in the cost of land and the continued desire for people to live near dynamic urban centers may contribute to increasing this type of project. For example, even certain residential neighborhoods are seeing the development of rooftop additions as they are starting to make economic sense. Of course, rooftop projects are not new for large and dense cities such as New York or Chicago but they are usually limited to high end single-family dwelling. Considering the continuing pressure to build more affordable housing in or near vibrant urban centers this type of project may become increasingly appealing in the US as a part of a broader effort of subsidized affordable housing.

2. ROOFTOP ADDITIONS AS PROJECT PEDAGOGY

The student rooftop project presented in this paper took place over a one-month period in the summer of 2021. It brought together students from schools of architecture located on three continents, America, Africa and Europe. In the context of the pandemic confinement and its constraint, we imagined a project occurring entirely online and using the latest virtual reality technologies. German students designed their project on a site in Mauritius, Mauritians in the US and American students in Germany. German students had to design a light, dismountable rooftop structure that could be used for tourist rentals while the Mauritian group focused on the transformation of an existing building in XXXX into

a visible landmark and a convivial space. The concept consisted in creating a new focal point within an existing and somewhat homogenous urban fabric. In a different urban context, American students envisioned rooftop additions in the city of Hamburg, where the question of density is critical due to the lack of options for the city to expand.

	Engage	Hub Mozilla	Spatial
Cost	free/pay	free	free/pay
Multiple Visitors	3 free / 70 pay	25	50
3D upload	library	custom	custom
Custom Environment	no	yes	yes
Graphic upload	yes	yes	yes
Avatars	toon	toon	real
Interactions	yes	yes	yes

Figure 4: Comparative platform evaluation. (Lescop 2021)

This project was structured based on an original set of communication tools and platforms. Most online platforms typically offer limited interactivity and their pedagogical efficiency can vary broadly based on the format of the courses. Platforms such as ConceptBoard, Miro or Zoom allow participants to share graphics and annotate but means of communication are still restricted when compared the traditional studio. Therefore, the idea was to find a freely accessible platform with as few restrictions as possible as to how it could be used. After evaluating various options, we identified the social platforms whose development accelerated during the pandemic. Originally conceived as meeting places, social platforms have evolved as additional learning vehicles for offices and educational institutions. They have moved away from serving a purely social purpose and include features such as presentation, drawing, animation and, of course, conversation. We considered three platforms: Engage (engagementvr.io), Mozilla Hub (hubs.mozilla.com) and Spatial (Spatial.io). A thematic search found Engage and Spatial on Oculus Store and Mozilla Hub. Engage and Spatial have a free and a paid version, and Mozilla Hub is completely free. The Spatial application was chosen as it offers the most flexibility for users and facilitates the customisation of its environment, allowing full scale virtual tours. Spatial also enables multiple visitors along with realistic avatars, which adds to the quality of the overall experience.

The context of the pandemic was originally the driving force to make us rethink our pedagogical strategy and adapt to new limitations. At the same time, these new constraints have revealed new possibilities that seem to open the way to new configurations and practices in the fields of pedagogy, mediation and museography. The cross-platform experience allowed a wide audience to benefit from an experience adapted to their hardware and timing. It also brought virtual reality experiences and contributed to social interactions that had been sorely lacking. Spatial can be used with a computer, a virtual and augmented reality phone, and especially with an immersive headset such as Quest. In this way, we have attempted to reconcile an individual experience with a collective one and to capture some of the spirit of the traditional architecture studio.

Students recreated virtual studios and gave real substance to their projects by designing sophisticated display areas, presenting models at different scales and creating a spatial environment for their project in which guests could walk and discover at full scale. In the early stages, the project was hampered by the quality of the equipment, the quality of the internet connection and the clarity of the audio. We gradually learned to calibrate the projects to resolve these issues. In the end the headset experience is the one that brought an interactive, immersive and innovative dimension to the project.

As mentioned above and after we went through a period of trial and error, students were able to bring and display a variety of media and model types within the Spatial platform. The artifacts uploaded in the immersive virtual space included slideshow type presentations with 2D and 3D drawings, small scale site models, virtual large-scale structural models and full-scale building models. Depending on their preference, students relied on a variety of formats to present their projects though everyone used a slideshow as a thread for the actual presentation. Most students complemented their slideshow with small site and 3D building models while others opted for interactive spatial structures and a few created custom virtual environments inspired by their design concepts and project themes.

Among the positive outcomes of the project, the variety of scales displayed in the 3D models created by the students should be mentioned. In fact, projects were presented at full scale, allowing for an immersive experience but also at smaller scales to provide context. The broad range of formats, including slideshows and 2D drawings, allowed participants to benefit from an audio-visual presentation while walking through a space or looking at model details. Another interesting aspect of the immersive virtual environment is the fact that participants were involved in a collective experience. The presence of the participants' avatars created a sense of community, though virtual but nonetheless important for presentations and feedback as students could relate to human bodies engaged in space. The most significant outcome of using a VR format came as a surprise and consisted in the fact that some students customized

the virtual environment where their project was displayed. They created original spatial features either derived from the physical structure of their building or inspired by their architectural concepts. The results were as effective as they were unexpected and these constructs created a unique experience, which contributed to communicate specific project narratives. These creations were rich and unique and were only made possible by a virtual environment. These unusual designs along with all the project artifacts can then remain on this virtual platform without being disturbed allowing recurring visits in the future. It seems a contradiction to think of a virtual environment as a place of permanence and repository but it is actually in line with the current use of all cloud-based storage database.

Overall, this project was mostly positive though we can point to some of the difficulties experienced along the way. The quality of the 3D models was crucial to their deployment in a virtual environment and the conversion from a 3D software to the Spatial platform required a mastery of polygons, textures and baking. These aspects are important both for the model definition and proper lighting. Exporting formats was also key to the overall process being successful. Based on the 30 MB upload limit in Spatial, models remain low in details but strategies were developed to fragment their geometry and reassemble them at a later time. Another important take away from this exercise is that the use of VR headsets provided an enhanced experience and a truly immersive one.

In the end, the multi-user virtual environment was found helpful by students in order to express their design ideas. In contrast, the virtual platform format seemed less conducive to the design development process. Nevertheless, the virtual spaces allowed students to create project related artefacts, which helped them develop a sense of ownership with their project and presentation. This type of new environment seems to increase student engagement during presentations and through exploring peer projects. It also appears to help students grasp project elements of different scales and develop more sophisticated presentation formats. This initial experiment points to the fact that virtual environments can expand the realm of the traditional studio beyond its physical boundaries and allow promising new modes of expression and engagement between peers and instructors and help connect different universities.

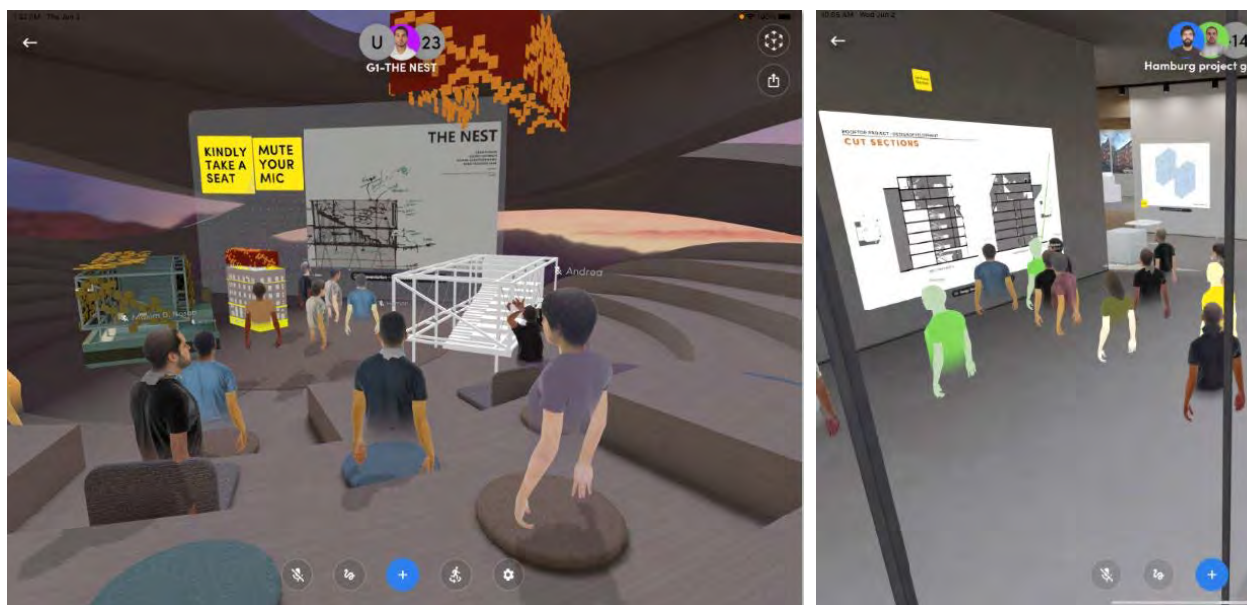

Figure 5: Immersive student project presentation using the Spatial platform. (Chamel 2021)

3. CONCLUDING THOUGHTS

The various examples of rooftop additions presented in this paper, whether in Hamburg, Mauritius, France or the US are all representative of very specific contexts with different needs and challenges. The European case studies respond to the physical limits of existing land and a commitment to more sustainable urban design practices. But rooftop additions are not only a sustainable strategy of urban growth, they are also a means to create more inclusive urban landscapes by providing more affordable housing in dynamic cities. Large scale and publicly funded rooftop projects developed in Germany are the result of very specific demographic pressures and physical constraints. Nevertheless, they are of value for other urban centers dealing with similar issues but defined by different cultural approaches. American cities for instance, cannot continue to expand indefinitely even though land is available. It is clear that this type of physical growth is no longer sustainable with regards to infrastructures, commute time, pollution and a whole array of related issues. Rooftop additions can offer solutions to different problems in a variety of urban contexts. They may be multi-family units, rentals, offices or commercial developments depending on local needs.

They also take advantage of technological improvements in prefab construction and offer less wasteful, better-quality energy-efficient structures. It is not too far-fetched to imagine 3D printed rooftop additions using lightweight composite materials.

Rooftop additions also present an opportunity to develop an architectural language and forms that take into account existing buildings. This is interesting pedagogically because it challenges students to understand and engage with history, urban patterns, building typologies and structural requirements in different cultural contexts. It is especially important in this era where globalization is heralded as a way for people to engage and exchange but not necessarily understand one another's culture. Rooftop projects can present opportunities for students and architects around the world to develop meaningful architecture, which engages and responds to peoples' culture and the unique challenges they face.

REFERENCES

- BBSR. „Wo die Bevölkerung in Europa wächst und wo sie schrumpft“, 14. Juni 2015.
https://www.bbsr.bund.de/BBSR/DE/themen/_alt/Raumentwicklung/RaumentwicklungEuropa/Projekte/Bevoelkerungsentwicklung/Bevoelkerungsentwicklung.html.
- Behörde für Stadtentwicklung und Umwelt. „Gutachten zu Potentialen von Dachgeschossaufstockung und -ausbau in Hamburg“, 30. Mai 2018. <http://preview.poc.hamburg.de/hhcae-cm7/servlet/segment/transparenz>.
- Beinhauer, Peter. 2009. Standard-Detail-Sammlung Bauen im Bestand : mit 199 Detailkonstruktionen. Köln: Müller.
- Dahlgrün, Bernd. 2016. „Innerstädtische Gebäudeaufstockungen in Hamburg : konstruktive, rechtliche und gestalterische Rahmenbedingungen“. HafenCity Universität. http://edoc.sub.uni-hamburg.de/hcu/frontdoor.php?source_opus=317.
- Dalladas, Oliver. 2017. „GIS-gestützte Abschätzung des Gebäudeaufstockungspotentials in Hamburg“. Master-Thesis, HafenCity Universität Hamburg.
http://www.geomatik-hamburg.de/g2lab/hcu_geb-aufstockung.html.
- Dederich, Ludger. 2014. „Dachaufstockungen zur städtischen Nachverdichtung mit resilientem Innenraumklima, Lübeck“,. In Klimawandel auf norddeutschen Dächern, herausgegeben von G. Conradi, KLIMZUG-NORD Dokumentation zum Teilvorhaben 5:27–55. Lübeck,.
<http://klimzug-nord.de/index.php/page/2009-05-25-Publikationen>.
- „Deutschland-Studie 2015: Wohnraumpotentiale durch Aufstockungen“. Studie. Darmstadt/Hannover: Technische Universität Darmstadt, ISP Eduard Pestel Institut für Systemforschung e. V., 29. Februar 2016.
- Dorner, Georg. „Tragwerksanalyse von Aufstockungen in Holzbauweise“. Masterarbeit, Kunstuniversität, 2010.
http://search.obvsg.at/primolibweb/action/dlDisplay.do?vid=ACC&docId=ACC_aleph008291955&afterPDS=true.
- Glaeser, Edward L. 2012. Triumph of the City: How Our Greatest Invention Makes Us Richer, Smarter, Greener, Healthier, and Happier. New York, NY: Penguin Books.
- Eimsbütteler Nachrichten. November 2016. „Hamburg ist Deutschlands Stauhauptstadt“, 30.
- Wietzorrek, Ulrike, und Thomas Jocher. 2018. Dachräume: Entwerfen, Konstruieren, Bewohnen. Erste Auflage. DETAIL Special. München: Edition DETAIL.

Metropolitan Cartography: An Inventive Practice Tool for Caring Metropolitan Landscapes

Antonella Contin¹, Valentina Galiulo^{1,2}, Domingo Sánchez Fuentes²

¹Politecnico di Milano, Milano, ITALY

²Escuela Técnica Superior de Arquitectura de Sevilla, Sevilla, SPAIN

ABSTRACT: To focus on issues of the resilient city on the metropolitan scale, it is important to understand the metropolitan city as a system that uses complementary actions to work with local projects for maintenance to preserve, improvement to increase, and transformation to grow, increasing the scale of local projects. Metropolitan City is a system that allows places to relate to each other in order to implement and care for metropolitan landscapes and their resources. To outline and give a spatial image to these relationships, the maps of Metropolitan Cartography are projects that identify the spatial components that make the landscapes dynamic, order spatial categories according to a new taxonomy for mapping the urban-rural interdependence of spaces, and structure gradients of tonal rhythms of landscapes that can be reprogrammed for new inventive patterns of land-use. Metropolitan Cartography (MC) is therefore a methodology capable of interpolating spatial data in a new synthetic map for digital design practices. With MC maps, it is possible to spatialize new land-use patterns from the global to local scales by mapping open-source data obtained through data mining, data setting, and data graphic semiology following the metropolitan architecture design process. In particular, the Metropolitan Cartography experiment allows us to contextualize qualitative and quantitative open-source data, finding and highlighting implicit relationships between heterogeneous informative layers which help to characterize the state of care and neglect of metropolitan landscapes at 'southern latitudes'. Thus, the operational findings of Metropolitan Cartography maps for caring Metropolitan Landscapes are outlined as methodological steps that make visible spatial relationships not yet detectable on the ground, which can be shaped by interpolating geographical, social, and economic factors. The maps allow for stages of project design and practices through repeatable and scalable open-data processing, which grants and supports sequences of logical choices for metropolitan architecture projects.

KEYWORDS: Metropolitan Cartography, Caring Metropolitan Landscapes, Digital Design, Inventive Practice, Open-data Processing

INTRODUCTION

Uncoupling the word 'resilience' from the metropolitan project

To focus on issues of the resilient city on the metropolitan scale, is important to start by analysing the concept of the metropolis. A metropolis is a system that uses complementary actions to work with local projects for maintenance to preserve, improvement to increase, and transformation to grow, boosting the scale of local projects. It is a system that allows places to relate to each other in order to implement and protect the territory and its resources. This is why we have introduced the 'metropolitan discipline'.

The metropolitan discipline addresses the complexity of the metropolis according to its physical, social, economic, and governance dimensions, understood and described in a theoretical framework called Metropolitan General Principles and Issues (MGIP). We define the conditions for dialogue and mutual understanding between different disciplines with the MGIP (common premises) and Glossary (common language). Using these, TELLme (an educational proposal under an Erasmus EU co-financed project) frames methodological steps, from Metro-dology to Metropolitan Cartography (Contin, Galiulo, 2020), for applying the MGIP to concrete metropolitan contexts. Metropolitan Cartography is used to establish relationships among selected elements and to refer simple data to the concepts of the discipline and digital tools such as TELLme Hub, where the maps are visualized (Contin et al, 2021).

Metro-dology is also at the core of the TELLme project. It is the base used to build the pilot training experiences and training programme guidelines within the framework of the transverse competencies and management skills it aims to develop. Since the discipline is conceived as a theory built on practice, the influence of the tools predominates. The most relevant for training and cartography is the MGIP/Glossary, a software prototype deeply tied to project outputs.

In order to define a metropolitan architecture project, we argue that the interaction between the morphological, material, and discursive dimensions shapes the sense of corpo-reality as a structure of the habitat. In the context of bigness (Koolhaas, 1995), the imagined and desired sensory dimension produced from the spatial practice and experience of a society composed of bodies consubstantiates the act of inhabitation.

Beyond constituting the hinge of the metropolitan structure between green and grey infrastructure, the task of the metropolitan architecture project is to construct the affective scene, the new form of metropolitan urbanism, and strengthen a feeling of adequacy between the places and inhabitants. This achievement will increasingly consider the metropolitan landscape as a value, and economically important, understood as cultural built heritage and natural capital, one of the most critical elements for understanding the profound meaning of metropolitan public goods.

This question relates to the possibility of resilience for cities in 'southern latitude' countries, which are growing by 5% or more every year (Un-Habitat,2020). Obviously, the future tense posed by the radical problem of the cities' rate of growth indicates that the metropolitan architecture project cannot be reduced to the past, except as the past of the future. Resilience is not an antidote to the fear of climate change; the fear of loss remains as it is. Instead, we need to understand its reality (herein lies the meaning of our risk maps), which also includes transforming the city into a metropolis through predictive technologies and the algorithms of metropolitan managers and climate experts. However, the metropolis will not be realized as anticipated in the algorithm.

This is the problem of the future. What does the algorithm that plans and manages our future and that of cities look like, so that we can fix the certainty of today? Fixing the proper terms of the algorithm today provides certainty about the future. This is the value of the tool that we have called Metropolitan Cartography. Before executing the works of what has been managed through an algorithm, we create a deep understanding of 'where' to recognize what cannot be erased (also using the Glossary software with keywords and related concepts).

1.1 What is the value we want to preserve for the near future?

For people emerging from a tribal phase, the practices of their remote past are the 'values'. The problem lies in the gap between values that are 'inadmissible' due to modernity, yet are present in the practices and 'values' now shared on a global level, which are the opposites of these practices. This problem is expressed in the question: How can endemic populations tune the 'other' values brought by globalization? This is the problem behind resilience.

In these contexts, the world's large banks finance infrastructure projects that will shortly be promoted and preserved as a memory of today because such projects, as new epicentres of the metropolitan city, are necessary for the metropolis to exist. The problem, then, is that in cities with this annual growth rate, we can go from no city to metropolis, and this will happen tomorrow.

However, the word 'metropolis' does not precisely fit today's cities, which are instead explosions towards the metropolis. The study of the metropolitan architecture project must therefore be left to scientists questioning what this very rapid transition from zero city to metropolis should be like today. This corresponds to an equally radical shift from tribal populations to somewhat technically equipped populations. Who will be the new citizens and how will revised tribal practices and state-of-the-art techniques fit together? That is the question lying at the heart of research concerning Metropolitan Cartography.

Our goal is to recode the model of city and territory on the metropolitan scale, which constitutes the pertinent horizon of the system of discourse and signification between all phases to construct the metropolis. Methodologically speaking, however, it will be challenging to find intellectual coherence between the different cultural perspectives, even if only through assonance. The city that serves as a model for everyone today is the smart city. Therefore, the initial question is why this model is not admissible in the 'southern latitudes' of metropolitan landscapes? To argue this, we would have to show that it is not permissible due to their cultural basis, territorial exposure, and sensitivity.

It may happen that a tribal country finds itself at a global conjuncture so powerful that it creates a metropolis even if the context lacks such preconditions, which now belong to the sphere of new techniques and technologies. A city can therefore remain tribal but know how to use the necessary techniques to make the metropolis function well or poorly. The city's functioning through techniques affects the behaviour of inhabitants and is therefore a powerful vehicle in the path towards assimilating non-sustainable behaviours.

1.2 Metropolitan expansion. Other cities and their knowledge

The cultural framework must be clarified if we consider today's 'non-plan' city as a different city from the mainstream metropolitan idea, indeed, if we consider true 'southern latitude' cities where norms and practices coexist. Is this difference related to use? Ownership? Access? Is it historical? In short, we need to understand the matrix that holds different cities together today. What directs us in the search for a code of mediation between the cities (Fig.3,4) are today's construction and planning practices, which are scaled in time between practices that date back to the pre-colonial, colonial, and post-colonial phases.

We also need to include an analysis of areas of the city called 'urban extension' (Simone et al, 2017). These places evidence a sense of the multiplicity of logic, agreements, and constellations of power and the possibilities that have made and could make/form the processes of urbanization of metropolitan landscapes in the 'southern latitudes'.

According to A. Simone, the majority of these 'cities within the city' live and operate in spaces beyond the traditional settlements of what is conventionally understood as an urban core. These extensions say something uncertain and different about urbanization and living itself, its sensibilities, and its politics. They are places where thinking about the urban area and urbanity (Choay, 1965) is used to consider how practices and spaces can continuously prefigure the variable mathematics of evaluation and emancipation from the dominant culture of globalization. Here, liminal spaces open in the absence of a consensual development plan, and incompleteness allows various projects to emerge from the 'bottom' as changing times and speeds amid which it is difficult for anything to take hold. The extensions now pose critical questions about relationships, scales, temporality, the incipience of differences without the need for physical separation. How will new metropolitan epicentres that will act as nodes be structured with these extensions?

This will only be possible if they are multipolar and situated in a variety of flows. It is a process that reaffirms the fundamental instability of the inter-connectivity of these metropolitan territories and a potential space from which the resistance of tradition and illicit or 'informal' uses might emerge. It therefore requires the ability to anticipate instability and prevent disruptions by studying past data.

However, these places of possibility expand into the metropolitan issue of places where different instances meet; this possibility of different people meeting is a behavioural problem. We must also encounter in these places the project of metropolitan centralities negotiated by global multilateral agreements.

2.1 Methodological context: Heterotopia as a different metropolitan rhythm

Our research concerns the great metropolises in explosively developing countries of the 'southern latitudes', where we study the influence of the surrounding context on metropolitan governance. Here, the relationships between times and values are never linear or mechanical but change with shape. There are no absolute scenarios but proportions to be taken care. Different relationships among the elements of Metropolitan Cartography section strategies across the pre-colonial, colonial, and post-colonial city thresholds establishing:

- 1) resonance [1]
- 2) plot
- 3) growth

There is a functional integration of the past and vibration, a feeling of common belonging. The map projects in Metropolitan Cartography, which are used to support design choices in metropolitan architecture projects, must trigger relevant relationships (even fragile ones) moving through a shared value and vision to be realized. The visions must be projected to manage metropolitan complexity.

Through Metropolitan Cartography, our interpretation of the concept of heterotopia (Shane, 2005) is related to mapping different metropolitan rhythms, or gradients of formality, within different attributes that can be identified along a section of virtual landscape running through the historical nucleus, colonial city, and city expansion.

In particular, from the metropolitan city centre to middle-sized municipalities in the metropolitan region, the design strategies of Metropolitan Cartography aim to discern collective values, recognizable planning, and construction practices. With a view to a diachronic reading of inheritance, we identify the cultural transformation of change.

We consider two approaches to metropolitan urban design. The first is the 'deep structure' type, which consists of principles referring to basic structural features such as the appearance of streets and other transport systems, the way buildings relate to them, pedestrian access, and the ability of the built form to adapt over time. These shape the collective memory of a place. The second is the 'superstructure' type, in which each new era — each urban generation — brings new values to the visual character and new demands for the functions of the built environment.

This is why it is crucial to work with a vertical narrative, or rather, a process of inclusion and deconstruction to read multiple identities, their meaning, and their representation, avoiding the cognitive redundancy of traditional governance. Narrative infrastructure therefore forms a bridge between the physical and virtual heritage of places, which Metropolitan Cartography aims to communicate by means of synthetic and scalable cartographic models relying on an experimental method for caring Metropolitan Landscapes.

2.2 Metropolitan Cartography: Data for transformation, data for Innovation

We are now in a transitional phase between the IoT (Internet of Things) and IoE (Internet of Everything), in which knowledge and awareness of the relationships between places and objects is conveyed by the Internet and computer mediators that facilitate connection to hyper-planetary connectivity. This is understood as necessary for the construction of new connections, not only between devices, but also between users and people through increasingly intelligent

networks capable of learning and returning information with greater security (Cisco, 2014). We are in the deep dimension of the meta-city (Shane, 2014).

In the scientific debate between technical and humanistic disciplines, however, there is a clear need to transfer and inform the narrative infrastructure of city places through inventive pedagogical approaches supported by technology. With Metropolitan Cartography (MC), a methodological and technological tool, it is possible to construct an image of the narrative architecture of the metropolitan territory by manipulating and spatially representing open-source data, from global data to the modelling and verification of local data.

However, Metropolitan Cartography is also a tool for modelling and designing the backbone of cartographic information packages (through the relationship Glossary and Metropolitan Data Set for Geographic Information Systems). The MC is a tool that uses maps to recount the affective image of a ground project (Secchi, 1986) and the long-lasting evolution of the complex metropolitan territorial and urban system, as well as the involvement of metropolitan citizens in map-making practices. The experimental application of the MC methodology in heterogeneous metropolitan contexts has therefore not only enabled the construction of cartographic products, but has also allowed us to consolidate systemic, multidisciplinary knowledge aimed at ensuring the spatialization of new relationships between metropolitan lines/life stratigraphy (Boano, 2021) and modelling times. For our research, the term 'inventive' (Naveh, 1994) emphasizes a research approach committed to analysing, interpreting, and reacting to critical environmental and social problems in order to achieve a research path for the transformation and innovation of metropolitan planning on the urban scale through metropolitan architecture projects (Contin, Galiulo, 2020).

Thus, the Metropolitan Cartography maps define the characteristics of the 'deep structure' of metropolitan landscapes through the relationship Glossary and Map (Contin, Galiulo, 2020), since they must not only be recognized, protected, and governed, but also redesigned for the near future. A new approach to the design of metropolitan places must not only go beyond a merely adaptive approach; it must also be able to move towards a projective design proposal through cartographic maps. Moreover, through the methodological experimentation of Metropolitan Cartography and the construction of cartographic projects in GIS systems, the research includes the possibility of detecting, imagining, and modelling new spatial relationships between landscape spaces (Galiulo, 2021) through data mining, data setting, and data semiotics in open-access map-making.

2.3 Methodology: Data mining, data setting, and data graphic semiology following the metropolitan Architecture design process

Metropolitan Cartography maps also allow us to assess and interpret the limits beyond which the vulnerability of the metropolitan territory reaches an unsustainable threshold, enabling planners to develop a prevention and transformation project compatible with these limits. Each Metropolitan Cartography map is created using a semantic package containing keywords and related concepts (Fig.2) that articulate the territorial components related to a spatial condition inherent in the physical dimension of the territory. The relationship between the parts (keywords, related concepts, informative levels, metadata) in the Metropolitan Cartography methodological system follows a simple cause/effect principle that represents the current complexity because it crosses the four dimensions of the metropolitan city addressed by Metropolitan Cartography and TELLme. This cognitive process produces a second set of maps which is called a set of dynamic maps in Metropolitan Cartography because it is capable of presenting the dynamics of metropolitan processes occurring in the territory, implicitly conveying a strategic project forecast (Fig.3).

It is here that the three methodological phases of MC — *data mining, data setting, and data graphic semiology* — come into play to construct cartographic projects for the knowledge of 'southern latitude' Metropolitan Landscapes. Data mining finds and unearths the primary associations, the recurring information patterns (geographical information patterns), and also anomalies in the information that might be received in open-source data from international, national, regional, and even local geoportals of the metropolitan city under study. Although manual, this preliminary phase of data selection and critical analysis allows information essential for configuring the invariant and tectonic structure of the territory to be discerned in the network system of open-access information. According to the design principles of the metropolitan architecture project supported by Metropolitan Cartography, the dissemination of inventive and strategic knowledge occurs by planning a metropolitan database that makes multidisciplinary information explicit according to a dimensional, textual, multimedia association of 'hybrid' data, which obtain an ordered, clustered, shareable, and reliable configuration and collocation in the data setting phase. It is therefore an initial phase of Knowledge Discovery in Databases (KDD) (Fayyad et al, 1996) (Fig.1), which does not end with the choice of data, but continues with their spatialization and verification in the 'map space' of the data design considering categories of data validity and reliability.

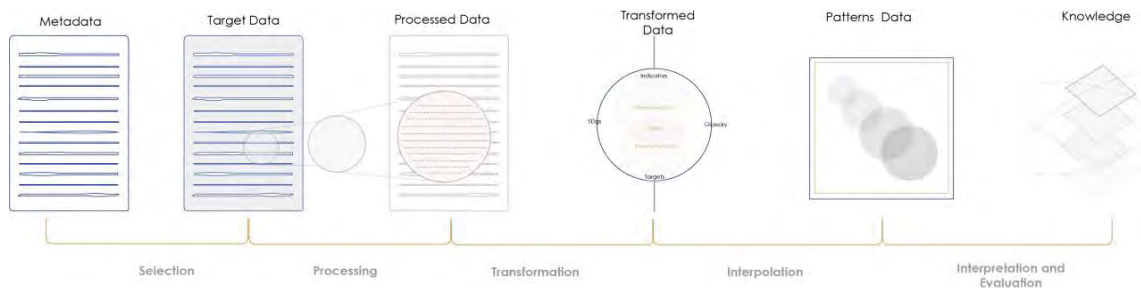

Figure 1: Data mining process in Metropolitan Cartography for KDD. Source: Galiulo, 2021

To support the data search phase, Metropolitan Cartography allows for the selection of connectivity relationships necessary for representing a specific ground phenomenon through multi-scale maps. Metropolitan Cartography guides the planner through the phases to acquire and filter data to facilitate the construction of a replicable, comparable, and scalable model in heterogeneous metropolitan contexts. The digital design processes of MC advise the planner in modelling the data following an initial analysis and interpretation of the information layers with respect to scalar relationships and the programmatic purpose of the map. Thus, to support the design choices of metropolitan architecture projects, the criteria guiding the process of selection, critical analysis, and spatialization of the data (data mining), cataloguing, cleaning, pre-processing, and connection of the data with the Glossary (data setting), and modelling and dressing of the data (data graphic semiology) are:

- identification of the purpose of the research in relation to the project map, which is independent of the design objective;
- pre-selection of the data to achieve it according to an initial classification based on the geographic dimension of the application (XXL; XL; L; M; S) and scale of representation (1:500000; 1:250000, 1: 100000, 1:50000, 1:25000);
- identification of a sequence of historical data (time series) that enables a series of interrelationships between evolving physical variables to be identified, ordering them with respect to the dynamics expressed in a given phenomenon;
- categorization of the concept and data, from the semantic package to the map, through the use of ISO 37120: 2014 standards, indicators for urban services and quality of life for sustainable development defined by the United Nations Member States (Sustainable Development Goals), as set out in the 2030 Agenda for Sustainable Development;
- data cleaning and pre-processing: further classification of attributes in the data necessary to represent the phenomenon spatially, choice of how to deal with incomplete or empty fields, final selection of key information for the ideal reference model;
- data dressing and modelling: transformation of the original data format and modelling of the data by means of data cleaning, filtering of GIS geoprocessing and sémiologie graphique rules (Bertin, 1967) for Metropolitan Cartography (Galiulo, 2021);
- interpretation of the preliminary results, categorized and ordered according to a new explanatory taxonomy of the metropolitan phenomenon under study, and their visualization according to a scalar and dimensional relationship consistent with the purpose of the project.

It follows that in spatial data mining, the criteria capable of extracting implicit knowledge from data and information patterns are determined by the need for research and knowledge of the territory. Therefore, it is necessary to define spatial rules through which the usefulness of global or local data for cartographic representation can be compared and understood according to a trans-scalar proposal of metropolitan dimensions: the physical, social, economic, and governance of the metropolitan territory. The spatial data analysis is crucial for investigating the properties of the selected information, so spatial analysis always requires mapping the spatial attributes of the information levels and also the quantitative levels related to the economy, in order to guarantee their communicative efficiency in the decision-making process through scale-data relationships (XL-L-M). From this research, it can be deduced that drafting a Metropolitan Cartography project allows experts to become familiar with the territory by understanding its structure, identifying events and causes, whether in progress or evolving, that trigger factors of development and critical regression of the metropolitan context according to a resilient, inventive, and therefore transformative approach.

3.1 Findings: Metropolitan Cartography as design strategy tools for technological implementation

The preliminary research findings, which were tested in European and 'southern latitude' metropolitan cities, allowed us to highlight the potential of Metropolitan Cartography as a design strategy tool for technological implementation across the metropolitan and urban-rural scales.

First, Green-Grey infrastructure Protocol Maps from the XXL, XL, L to the M, S, XS scales of the metropolitan region provide spatial information according to a large- and small-scale design purposes: an integrated green infrastructure system through the spatial continuity principle. Nevertheless, the intention of the design strategy is to highlight the infrastructural discontinuity between the metropolitan centrality and medium and small cities in the metropolitan network system. Starting with the structure of the semantic package taxonomy, the open-source maps represent:

- The relationship between the spatial components of Green infrastructure as a descriptive network system in the existing ecological framework of the territory;
- Grey infrastructure to depict anthropogeographic (Gregotti, 1967) spatial components that constitute the structural link between the metropolitan city and possible new small and medium-sized centralities in the network of metropolitan landscapes;
- Blue infrastructure exemplifying the water systems and apparatus in the metropolitan region according to its definition on a hyperlocal scale;
- Physiography representing the lithological and topographical components of the soil on which the metropolitan infrastructure is built;
- Cultural heritage, which describes the pre-existence and socio-environmental permanence of the metropolitan landscapes in transformation and innovation.

Protocol: Green-Grey {XL}

BLUE INFRASTRUCTURE	GREEN INFRASTRUCTURE	PHYSIOGRAPHY
Body of water_lakes	Protected areas	Lithology_Soil composition
Body of water_rivers	Vegetation coverage	Morphology_Elevation
Body of water_wetlands		
Flood areas	GREY INFRASTRUCTURE	
Groundwater	Airports	
	Built up area	
BORDERS_CATEGORISATION	Pipeline_energy	
Administrative Boundaries_Region	Pipeline_water	
Transitions Zone	Port	
Water Authority_primary	Railway	
	Road network	
	Telecommunication tower	

Figure 2: Green-Grey Protocol maps XL Semantic Package. Source: Galiulo,Contin, Sánchez Fuentes 2020

The Green-Grey infrastructure Protocol XL map makes it possible to observe the territory through the representation of green, grey, and blue infrastructure, which constitutes the main structural layer for the formation of the ecological armatures of the Net City (Shane, 2005). Therefore, to understand the importance of the metropolitan revolution on local territories, it is necessary to analyse the impact that the network of intermediate cities must bear due to changes that have occurred at the heart of national economic structures and the changes in morphological and geological adaptation. The main operation when managing explosive growth consists of territorial reinforcements or linear systems that ensure the continuity of the infrastructure network and landscape units. The aim of Green-Grey infrastructure is to develop an image of spatial growth, allowing for accessibility and regulating growth in areas with strong natural risks and a loss of environmental resources. To achieve these objectives, ecological reinforcements must lead to a system of predominantly open spaces to be protected through specific uses, strengthening environmental regeneration and ensuring the robustness of the system to allow the structure to transform under conditions of green-grey infrastructure continuity. The entire system operates as a landscape hub that interacts in different ways, such as through protection,

renaturalization, and reconnection. This creates a possible ecosystem infrastructure, which provides ecological services, i.e. benefits provided by the goods and services in an ecosystem. These are considered inalienable common goods for the metropolitan dimension of the city and the ecosystem approach should form the basis of a metropolitan strategy that integrates the management of land, water, and living resources and promotes conservation and sustainable use more fairly through metropolitan architecture projects (Fig.4).

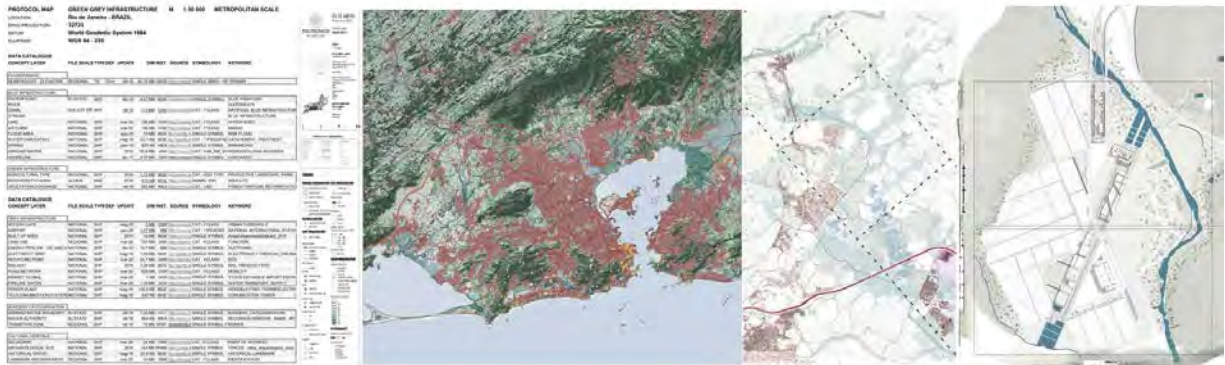

Figure 3: Rio de Janeiro – Southern latitude metropolis. From data mining and setting, Green-Grey Protocol Map L, Green-Grey Protocol Map M, towards a metropolitan architecture project. Demonstrating how data research and the composition of the Metropolitan Cartography map project must follow the objective of the project on an architectural scale. Source: Contin,Galiulo, 2021



Figure 4: Guadalajara – 'Southern latitude' metropolis. From data mining and setting, Green-Grey Protocol Map L, Green-Grey Protocol Map M, towards a metropolitan architecture Project. Demonstrating how data research and the composition of the Metropolitan Cartography map project must follow the objective of the project on an architectural scale. Source: Contin,Galiulo, 2021

CONCLUSION

The disciplinary issue related to metropolitan 'nature'. Caring metropolitan cities through maps

In the context of these new metropolitan epicentres, is there a real space that cares for territorial elements? What of the past must be made to resist? These questions present a new phase of the city that must be managed with new tools towards a new vision of sustainability.

Care for our territories is therefore not only the result of social and economic evolutionary processes, but can be understood as the active reaction to a system of physical and environmental gradient inequalities in the urban-rural context. If society in the cities of the future were to organize itself according to a new awareness of caring for the anthropic and non-anthropic components of the city, it would be possible to operationally redefine the concepts of sustainability and resilience, which would no longer be tied only to resistance to the metabolic evolution of the city, but above all to inventive knowledge about the environment in which it is rooted. Therefore, the research of Metropolitan Cartography for caring Metropolitan Landscapes, explained through map projects on different scales, could be supported and implemented through new connections among spatial information that can activate design predictions related to the future habitability of hybrid spaces in extremely vulnerable metropolitan territories.

Metropolitan Cartography maps therefore contribute to communicating the need for a new metropolitan vision with a multidisciplinary perspective that moves away from the traditional objective of functional efficiency and the economic prosperity of the city. Metropolitan Cartography maps also support the evolution of the spatio-temporal image of fragile

territories so that they can be understood as new possible spaces to achieve the equitable well-being of inhabitants living in the metropolitan area. The maps support a qualitative assessment that is not limited to the construction of functional efficiency parameters in the urban-rural structure. Our perspective is based on the interpolation of different levels of information discretized according to the relationships between physical, social, economic, and health dimensions in the contemporary metropolis. Metropolitan Cartography for caring metropolitan landscapes then becomes a practice of territorial knowledge, collective urban and architectural knowledge for a new operational perspective. MC maps are qualitative tools to visualize spatial relationships that are not yet detectable on the ground but can be shaped by interpolating geographical, social, and economic factors and also through open-source mapping, which sustains and supports logical project choices, from the preliminary urban design phase to the architectural design, through metropolitan architecture projects.

REFERENCES

- Bertin J. 1967. *Semiologie Graphique*. Paris: EHEES
- Boano, C. 2021. Contested Heritage Lecture. Politecnico di Milano_Polo Territoriale Piacenza, October, 26, 2021.
- Choay, F. 1965. *La Città. Utopie e Realtà*. Piccola Biblioteca Einaudi (2000): Segrate
- Cisco. 2014. Cisco Consulting Services, *The Internet of Everything: A \$19 Trillion Opportunity*, gennaio 2014, <http://www.cisco.com/web/services/portfolio/consulting-services/documents/consulting-services-capturing-ioe-value-aag.pdf>
- Contin, A., Giordano, P. and Nacke, M. (eds.). 2021. *Training for education, learning and leadership towards a new metropolitan discipline*. Inaugural book. Buenos Aires: CIPPEC. ISBN: 978-987-1479-50-4
- Contin, A. Galiulo, V. 2020. TELLme METROPOLITAN CARTOGRAPHY: Methodological device to choose quality space for new metropolitan morphotypes. In *Proceedings ISUF-H 20 Forma Urbis y Territorios Metropolitanos*, 28-29-30th of September. Barcellona: Universitat Politècnica de Catalunya ISBN: 978-84-9880-841-4
- Fayyad, U., Piatetsky-Shapiro, G., Smyth, P. 1996. *From Data Mining to Knowledge Discovery in Databases*. Retrieved from : <https://www.kdnuggets.com/gpspubs/aimag-kdd-overview-1996-Fayyad.pdf>
- Galiulo, V. 2021. *Envisioning Metropolitan Landscape through Metropolitan Cartography: Metropolitan Landscape dynamic interactions in the Milan case study*. In *Metropolitan Landscapes. Towards a Shared Construction of the Resilient City of the Future*, Springer: Berlin
- Gregotti, V. 1967. *Il territorio dell'Architettura*. Feltrinelli: Segrate
- Koolhaas, R. Mau, B. 1995. *S, M, L, XL: Small, Medium, Large, Extra-Large*. Sigler: Rotterdam
- Naveh, Z., Lieberman A.S., 1990. *Landscape Ecology. Theory and Application*, Student Editing. Springer-Verlag, New York
- Palanza, S. IAI. 2016. *Internet of things, big data e privacy: la triade del future*. Retrieved from: <https://www.iai.it/sites/default/files/iai1612.pdf>
- Shane, D.G. 2014. *Metacity: origins and implications*. In *Innovative Technologies in Urban Mapping*. Contin, A. Salerno, R., Paolini, P. (eds). Berlin: Springer
- Shane, D.G 2005. *Recombinant Urbanism. Conceptual Modeling in Architecture, Urban Design, and City Theory*. Chichester, UK: Wiley. ISBN: 978-0-470-09331-3
- Simone, A., Pieterse, E. 2017. *New Urban Worlds: Inhabiting Dissonant Times*. Cambridge UK: Polity Press. ISBN: 978-0-745-69156-5
- Un-Habitat, MetroHub. 2020. *METODOLOGÍAS Gestión y planificación metropolitana*. Nairobi: Programa de las Naciones Unidas para los Asentamientos Humanos. Retrieved from : https://unhabitat.org/sites/default/files/2020/08/metodologias_metrohub-07082020.pdf

ENDNOTES

¹ Resonance: In chemistry, the concept of resonance expresses the fact that a molecule always simultaneously presents the properties of various structures, due to which it can be considered a hybrid.

Nature-Based Solutions and Circular Economy: Structuring a Long-Term Project for a Climate Resilient Design

Kevin Santus¹

¹Politecnico di Milano, Milan, ITALY

ABSTRACT: The growing systemic fragility outlines the necessity to rethink the design action for a renewed relationship within societies and the environment. Climate change is shaping a new paradigm that urges human action to reduce the carbon footprint. At the same time, urban areas are showing an increasing need to gain more resistance to disruptive climate events. Thus, the research aims to present Nature-Based Solutions and Circular Economy as a unitary resilient design approach, displaying adaptation and mitigation actions to adapt our cities and mitigate further climate alterations. The contribution portrays the necessity of implementing the two approaches to structure a long-term project, going through the current scientific debate and displays some regeneration design projects. These are selected based on: regeneration projects at the neighborhood scale; the Circular Economy is applied to the material flows of built environment regeneration, reducing the CO₂ building impacts; Nature-Based Design addresses the reclamation of polluted lands and re-naturalizes the common ground to prevent climate risks. The configured design method opens to new practices that could foster the preparedness for climate change events and design a more resilient built environment. Consequentially, resilience is defined by applying adaptation and mitigation action to prevent climate risks, adapt the urban space, and improve the usage of resources. Finally, the research will question the morpho-typological modification that resilience can bring to the contemporary design panorama, claiming further research on the relationship between climate change and architecture.

KEYWORDS: Climate Change, Nature-based solution, Circular economy, Urban regeneration, Resilience

INTRODUCTION - A GLOBAL FRAMEWORK: CLIMATE CHANGE AND DESIGN

The theme of environmental risk and spatial responsiveness has been widely present within the design culture since the previous century. We could even argue that some of the contemporary practices that we spot as new design strategies are millenary operations that, with various names, have characterized the project's history. For example, experience such as the circular economy, looking at it as a design strategy, directly recalls the buildings reuse practice during the Roman/medieval periods, in which components of ruins or other constructions were removed and integrated into new artefacts. In addition, different themes, such as the one relating to nature and urban life, have repeatedly risen to the forefront of design ideas only to drop in developmental pressures, economic constraints and shifts in stylistic taste (Vidler 2010).

Nevertheless, the 20th century was central in structuring the basis for a growing sensibility toward the issue of sustainability and ecological responsibility (*Brundtland Report, Limits to Growth, Silent Spring* etc.). Indeed, these two themes have defined a structured path strengthened not only by the threats to environmental conservation but also by the evidence that risks such as climate change bring to the space we inhabit and live in every day. Thus, concerns about the planet's survival have acquired importance, and the climate emergency has undoubtedly emerged as a crucial issue since the beginning of the 21st century. Moreover, according to the International Panel for Climate Change (IPCC 2021) forecasts, the phenomena linked to climate variability will intensify in the coming decades, and extreme events related to the climate will increasingly constitute a social and ecological risk.

It is already clear how climate change cannot be considered an occurrence of the modern world or a temporary emergency; instead, it is a proper discontinuity of the previous global climate system. Because of this reason, we could argue that climate change is a *macro-catastrophe* (Bertin Maragno & Musco 2019) that is affecting the whole world, and it is amplified by human action (IPCC 2021). Furthermore, the consequences deriving from this environmental and climatic crisis are changing the balance of life on the planet (Crutzen 2000), producing a growing onset of risks, and accentuating pre-existing fragility and dangerous conditions.

This perspective clarifies how climate change is an unstoppable event and that it should also influence the design practice in defining the perspective in which we will structure the space within this different system.

Indeed, climate relapses are affecting the built environment and the space among buildings, producing an increasing onset of hazards: heat island effect, floods, hurricanes, and droughts, together with social injustices, economic crisis, and pandemics are shaping the current era, affecting people and spaces, defining an unbalanced framework.

This change seems to worsen within urban areas (Kabisch et al. 2017), where it is possible to find a stratification of complications due to climate fragilities, generally overlapped on previously unstable socio-spatial contexts such as peripheral or abandoned areas. Indeed, the climate risk could be considered as an

Anthropocentric concept, as it addresses damage to people and to assets that are at the same time located in a dangerous area, exposed to a given natural or man-made threat and vulnerable to the latter. (Menoni 2020, 27)

Therefore, it is urgent to study methods to face and counteract the effect of the changes, and urban areas can play a crucial role in this rethinking. Indeed, these are the primary place of CO₂ emissions, of which 36% are attributable to the construction sector, as well as the most densely populated contexts: in Europe, urban areas host about 72% of the population (United Nations, Department of Economic and Social Affairs 2014), with estimates potentially in growth. A critical path to tackle the issue of climate change is to increase the resilience of our urban systems, decreasing the carbon footprint of buildings and, on a broader level, rethinking the design action to adapt our city, increasing the natural carbon sequestration and reducing the threats derived from climate hazards. From these statements, in 2015, the Paris Agreement set three objectives:

- Limit the global temperature to increase more than 1.5 °C.
- Promote climate resilience and low carbon development by adapting to the various climate fragilities.
- Invest in resilient and low carbon development

Moreover, the United Nations, with the 17 sustainable Developments Goals (2015), defined a series of challenges to restructure our society and symbolize an urgent call to action to improve a transversal development, which one of the goals (the 13th) addresses explicitly the urgent action to combat the climate emergency, as an act of preservation of planet's and human's future.

This framework heavily impacts the construction of the city of the future, implying a rethinking of the design activities for the new areas of urban expansion and regeneration actions. During the last decades, various solutions have begun to spread in this direction, interacting with different types of fragility, deepening the consciousness of the relationship between ecology and design, and trying to interact with the issue of climate resilience from a different perspective.

Specifically, two main strategies have acquired centrality in recent years: the so-called nature-based solutions and the circular economy. Therefore, it is relevant to understand how these two tools can be framed as instruments to face a broad set of fragility, climatic at first. As a result, nature-based solutions and circular economy are not presented as punctual technical solutions but are considered in their ability to produce ecosystemic effects. Because of this reason, the contribution aims to show the possibility generated by the complementarity of nature-based solutions and circular economy. This complex condition defines the research framework, which considers the neglected urban areas that are facing or have concluded regeneration processes. Specifically, the contribution will highlight how the complementarity of nature-based solutions and circular economy can increase a site's resilience, affecting the reduction of carbon emissions and raising the capacity of the project to adapt to the urban environment.

1.0 METHOD

Starting with the threats of climate change, the necessity to increase the resiliency of the urban system is a direct consequence. The present research starts from this to state the different scope that nature-based solutions and circular economy can play across the design process and the main effects on the urban environment. Thanks to a broad literature review and supported by a series of case studies, this analysis has been conducted to emphasize the design practice relapses that long-term resilience and specific design strategies could have. The article will display three of these case studies, highlighting the complementarity of the two approaches. Specifically, to present the design perspective, the contribution considers regeneration projects settled in European urban neglected areas that addressed regeneration by applying jointly nature-based solutions and circular economy. These two strategies are recognized as emblematic not only for their increasing presence among several projects but also for considering the centrality they have in the European Agenda¹, thus modelling the financial and spatial future of Europe.

The case studies are analyzed highlighting their design procedure, in which is visible the use of nature-based solutions to restore grounds and the circularity as a renewed design mindset to approach the contemporary project, where also the regeneration of polluted soils and neglected areas can configure an action of urban reuse toward a circular city perspective. In detail, the projects reflect on the role of nature within the urban project, whether it is applied to the soil reclamation (De Ceuvel) or as a punctual solution as a green roof (Luchtpark Hofbogen). Circularity, instead, is studied in his conception of rethinking the material flows (Ilot de l'Arc de Triomphe), whether the study is applied to the singular constructing element or to the whole architecture as a reuse action.

The main scope of this contribution is to highlight design processes where adaptation and mitigation are conceived as complementary results to achieve long-term resilience to cope with climate change hazards. The two design tools are analyzed through a case studies analysis and then synthesized in a conceptual scheme that reflects the general strategies that we can find at the urban and architectural scale. The description of the projects is not aimed at deeply surveying their feature; instead, it shows some practices of regeneration in which the tool of nature-based solution and circularity are implemented not only as a technical solution but considering their impact in defining the spatial features of architecture in perspective able to increase the resilience of the urban space.

Finally, an open question will be raised regarding the morpho-typological issue when nature-based solutions and circular economy are displayed in a project, opening with some theoretical issues highlighted through the case studies presented. Indeed, the transition of the project, reflecting the necessity of increased urban resilience, is still lacking a reflection upon the construction of the architectural form.

2.0 PRACTICES OF REGENERATION

As already stated, concepts like resilience, mitigation, and adaptation, have gained a central role in the architectural debate, encouraging the construction of renewed narratives and practices, making interacting an ecological attitude with architecture and urban design (Bulkeley 2013). Indeed, many sustainable projects are rising, trying to cope with climate change threats (Hawken 2017). In this framework, nature-based solutions and circular economy can be studied as the main climate strategies affecting the design practice.

At first, it is crucial to understand how these two strategies can make projects more resilient to the climate emergency. These strategies, indeed, are based on the concept of making urban systems more resilient through adaptation and mitigation, so defining space as adaptable to future known and unknown shocks.

Although the application of circular logic can increase the adaptive capacity of communities (Amenta & Qu 2020) by acting on the local metabolism and establishing best practices with socio-economic implications, nature-based solutions show a high predisposition to structure spaces with high resilient capacity, in a perspective of urban adaptation of grounds. Mainly when applied to open space, they show positive effects in reducing the impacts such as the heat island, improving the urban microclimate (Musco & Fregolent 2014), and increasing urban biodiversity (Kabisch 2017), contributing to expanding the draining soils. Furthermore, these solutions play a significant role in constructing spaces that resist risks such as floods or rainstorms, which increasingly affect urbanized areas due to climate change. Concerning this theme, it is possible to find numerous projects that have introduced nature-based solutions as tools of urban resilience in a preventive or subsequent manner to a cataclysmic event. However, the role of nature within the contemporary project that aims to reclaim the urban grounds is not – or at least not only – related to the issue of nature in the city that shows a simplification of the theme, rather a proper adaptive process, where nature is an instrument of “adaptation rather than domination, ‘living with’ rather than ‘living over’.” (Hagan 2015).

Next to the adaptation, we can frame the second typology of the output of these resilient tools: mitigation. This is mainly focused on reducing greenhouse gas emissions to reduce the pressure of climate change. As the counterpart of adaptation, nature-based solutions play a minor role. In fact, despite acting in the subtraction of CO₂ from the air, it would seem that the main contribution to the reduction of climate-altering gases is found in the application of circular logic within the building processes. Considering the urban and architectural scale, the application of circular processes allows a reduction in CO₂ emissions (Cheshire 2016), acting through specific design solutions such as the maximization of dry construction (that allows future reuse of the building components), the reuse and recycling of materials, as well as greater control of flows of resources (energy and materials).

Talking about architecture, reuse, also in the direction of retrofitting abandoned built assets, is central in dealing with circularity; indeed, reducing carbon emission is also connected with better use of what is already built in our cities and in the ability to give to new projects the capability of being reused in future. Only in Europe:

The construction and operation of buildings occupy almost 40% of the depletion of natural resources and 25% of global waste. Construction and demolition waste has become a major source of urban waste and usually accounts for 10–30% of the total waste landfilled. In the European Union (EU), construction waste occupies more than 30% of the total solid waste. (Guo & Huag 2019, 1)

If we consider what is stated, regeneration processes of the built environment could have a central role in shaping the design transition and making more resilient our cities.

An example could be seen in De Ceuvel by Space&Matter. This low-density project, settled on a polluted dock of the former harbour of Amsterdam, restores the abandoned area through a long-term reclamation of the land (Figure 1), designing new public spaces from the reuse of retrofitted houseboats. Here, the studio Space&Matter and the landscape architect firm DELVA applied a long-term reclamation process started in 2014, using nature as a regeneration tool of the ground, specifically through the phytoremediation. This operation tries to regenerate and

restore the natural capital of the neighbourhood, acting on the removal of pollutants from the dock's ground to make it a renewed common space for the city. Ground reclamation was the starting action to enable the activities to come back to place. With the soil reclamation, Space&Matter decided to apply circular logics by sharing and reusing the city's physical assets. Indeed, the masterplan presets retrofitted houseboats connected through a raised element that configures a promenade that interacts with the neighbourhood scale, producing new public spaces. The integration of circular logics aimed at using the local materials, consuming fewer resources and reducing the carbon footprint of the whole regeneration process.

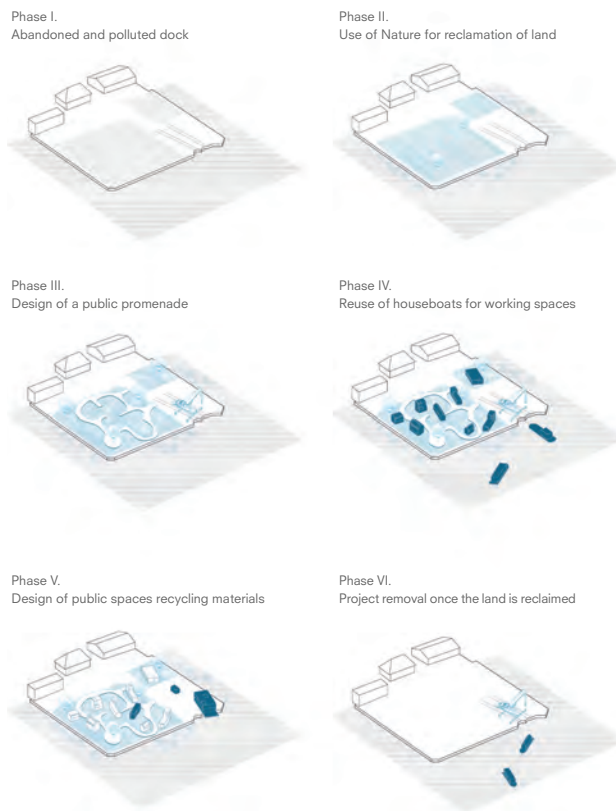

Figure 1: Schematic reinterpretation of various phases of the project, aimed to reclaim the land and reuse the physical asset of the city. Source: (Kevin Santus 2021)

On a similar logic, but at the urban level, works the project designed by ZUS, the Luchtsingel. In this intervention, the reuse of building rooftops and the re-naturalization of some parts of the city soils generated a new urban ecosystem connected by an urban, dry constructed wooden bridge. The project is settled in Rotterdam and aims to reconnect three city districts, implement green public areas, and restore the neglected landscape close to the railway. Highly important in this urban regeneration process is the Luchtpark Hofbogen (Figure 2).



Figure 2: The rooftop of the former Hofplein Station is transformed in a urban field, where the urban and natural experience touches. Source: (Kevin Santus 2021)

This green area regenerated the rooftop of the former Hofplein Station. Greenery and events revitalized the local community and gave a new ecological value to the site, implementing the city's green spaces. The project shows how the re-connection of public spaces, also reusing rooftops as artificial grounds for urban gardens, reactivates a neglected area and displays a complementary use of circularity embedded in the reuse of the building assets and through the application of nature-based solutions.

A third project, Ilot de l'Arc de Triomphe, settled in the French city of Saintes, displayed the regeneration of a neglected fabric, which was subject to frequent flood events due to the morphology of the territory and the absence of drainage soils. The regeneration operated a series of demolitions in the internal part of the neighbourhood to give a new configuration of the urban fabric and define a new ground permeability, increasing the green areas within the neighbourhood. Moreover, demolition debris management became an opportunity to reuse stone materials, setting up a circular, technical, and economical approach. The reuse of the debris becomes an integral part of the regeneration process, giving the material for constructing new buildings and for the paths within the neighbourhood. (Figure 3)



Figure 3: Ilot de l'Arc de Triomphe in Saintes: view from above of the general intervention (Source: BNR studio, 2021)

2.1. The complementarity as long-term project

Through these case studies, we could synthesize different approaches and scales. Nevertheless, what is presented is an evident complementarity of nature-based solutions and circular economy, able to blend adaptation and mitigation. These two tools are used in various ways but can represent a straightforward synthesis of the broader application of the two strategies that we could see on a more comprehensive design panorama and that can be synthesized as an operational set at the urban and architectural scale (Figure 4).

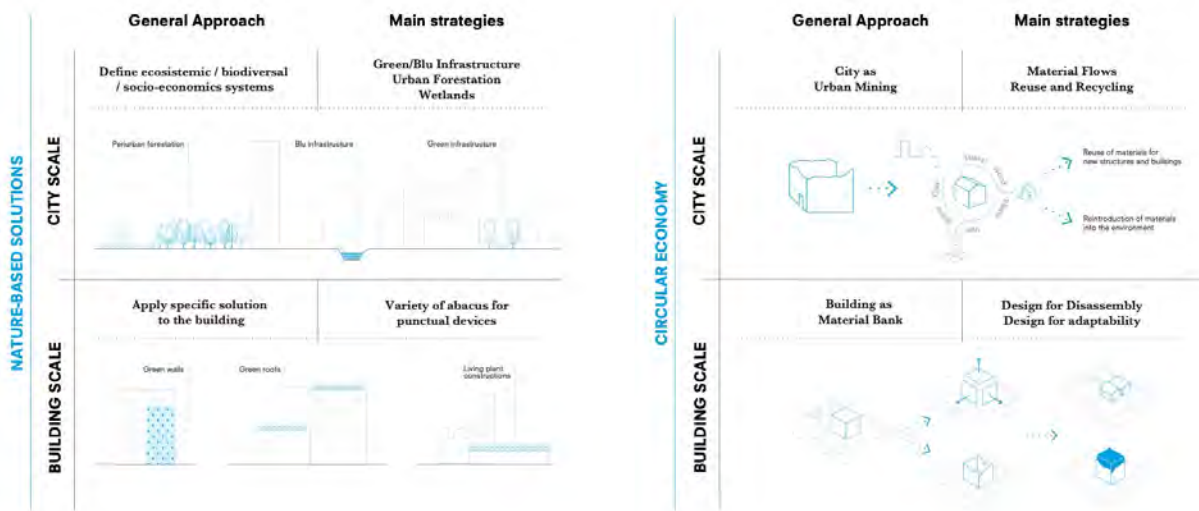

Figure 4: Schematic representation of the different approaches regarding the two design strategies. Source: (Kevin Santus 2021)

The transversal core of these regeneration projects is the idea of double action to deal with the climate emergency. Indeed, an interconnection between adaptation and mitigation is required to design urban spaces adapted to the new climate condition and, at the same time, contrast the increasing climate change acceleration (Steffen et al. 2015). In this context, the result that could be foreseen is fostering long-term resilience. Therefore, the design action to decarbonize and adapt the urban environment configures an interscalar perspective that requires a complementarity of tools to structure an effective, resilient environment. Hence to curb the carbon emission and adapt the space, making it able to counteract climate hazards.

Nadja Kabish in her book *Nature-Based Solutions to Climate Change Adaptation in Urban Areas: Linkages between Science, Policy and Practice* (2017) reflected upon the essential concept of long-term resilience that:

should not only be considered to be beneficial for current and immediate pressures from climate change but also be able to withstand potential future changes [...], both environmental and socio-political changes. Long-term resilience thinking [...] is of particular importance because challenges from climate change will further impact on urban society during the upcoming decades and require long-term adaptation thinking. p. 325.

Creating long-term resilience can produce renewed stability capable of socio-economic repercussions, producing a sustainable transition within the new system we live in.

In this perspective, it is, therefore, necessary to think of strategies capable of working on a transversal level, in which a complementarity of tools is crucial to involve ecosystemic repercussions (Dawson 2019). The concept of resilience itself can then be achieved only through an action that implements mitigation processes to climate change, so related to the decarbonization of the built environment, and at the same time act to adapt our cities and territories, making them able to cope with climate hazards.

A concrete path toward decarbonization of the built environment and a more resilient design approach should be addressed and verified both quantitatively and qualitatively. Nevertheless, if on the one hand we already have technical instruments for testing the quantitative impacts of projects (e.g. LCA to assess the environmental effects of all the stages of the life cycle), it is still to be investigated which could be a qualitative impact of a resilient attitude of the project, in which nature-based solution and circular economy are not framed just as a technical solution rather as potential tools to renovate the architectural language and environment.

3.0 A MORPHO-TYOLOGICAL INQUIRY: AN OPEN QUESTION

Already in 2008, Dean Hawkes highlighted in his introduction to *The Environmental Imagination* how the quantitative and measurable impacts of climate strategies should not avoid “the poetic interpretation of the nature of the architectural environment”, in which the technical issue of climate can be part of the aesthetic of the design form and experience.

However, looking at projects that applied nature-based solutions and/or circular economy, makes clear a lack in the design, where nature-based solutions and circular economy are interpreted more as technical solution rather than an integral part of the project. Nevertheless, as stated by Kenneth Frampton in his text *Urbanization and Its Discontents: Megaform and Sustainability* (2011):

There is no manifest reason why environmentally responsive and sustainable design should not be culturally stimulating and aesthetically expressive. Sustainability and its implicit aesthetics ought to be rightly regarded as a prime inspiration to enrich and deepen our emergent culture of architecture, rather than as some kind of restriction upon, or as something separate from, the fullness of its aesthetic and poetic potential. p. 108

Indeed, considering climate change as an issue that defines the new normality of contemporaneity, we could frame adaptation and mitigation as the core of this transition. Nevertheless, it is still vague which could be the morpho-typological effects of this transition. This urging question is strictly related to the role of architects when dealing with nature-based solution and circular economy. Indeed, in this changing design panorama, architects have to cope with adaptation and mitigation and, at the same time, acquire new expertise and know-how to manage them.

Sang Lee, in his book *Aesthetics of Sustainable Architecture* points out that:

In recent years, the so-called greening of architecture has produced a new class of experts and professionals. Sometimes they work in parallel with architects, while other times they perform in the background the work of effectively making a building design green after the architect's work is done. Given these trends, it is important to ask whether sustainability is indeed an area that is best left to this new class of experts and professionals or if every architect should engage it as an integral part of the design process.

Define long-term resilience, dealing with the complementarity of tools means to cope with the form of resilience, stating how to design new buildings and activate regeneration processes not as a technical solution but as a design action. Indeed, architects are the figures that give form to space, and as designers, we should investigate how the changing condition of our practice has relapses on the architectural form.

Starting with an analysis of the presented projects, we could argue that circularity and nature-based solutions could imply a primary reconsideration of the ground's conception and the possible implication that reused materials could produce upon the spatial form. The ground, especially in urban areas, represents a crucial issue. Often depleted and polluted, it is an essential resource for a safe urban environment, hosts human activities, and counteracts climate hazards. Because of these reasons, regeneration projects usually act on it, applying nature-based as technical tools to restore the soils. Nevertheless, the modification project is not related to the number of plants we cultivate but implies a design reflection. Indeed, operating with the ground means establishing the relationship between humans, building and open space. Thus, acting in a resilient perspective also means shaping our cities' renewed urban landscape, working with the ground as a new typological element, and connecting a single building with the city.

The material implications, derived from a circular use of the resources, are open to a broad discussion. Indeed, examples such as De Ceuvél show how the reuse of the entire houseboat highly impacts the design form of the project. Starting from this specific case study, we could frame a more generic perspective, thinking of extending the concept to reuse entire buildings or fabrics. This new possibility for the project directly implies a typological permanence of the form, in which the regeneration processes must work upon a given shape/structure. At the same time, the reuse of materials, as shown in Ilot de l'Arc de Triomphe, means rethinking the design process, which has to develop the project accurately relating materials and possible forms. In this sense, it is evident how reusing the building resources needed to re-establish a strong relationship between material and form representing a viable future for the practice that has always been present in the design culture, but nowadays is more than needed.

4.0 CONCLUSION

Given the above, one of the main contributions of this work is to open the discussion upon design strategies that could be used together to design and regenerate the urban built environment and increase the resilience of metropolitan systems. Specifically, the usage of nature-based solutions envisions the possibility of reclaiming polluted soils to settle a renewed dialectic between the urban minerality and nature, tackling the adaptation of the urban space. At the same time, applying a circular perspective to the project focuses the discussion on the project's resources, stressing the necessity to deal with what has been built in the previous decades and imposing new reflections regarding what we can do with what we already have. Together, these two strategies could establish a

long-term project where the design action plays a clear role in the definition of resilience. Considering the unbalanced framework stated at the beginning of the article, it is crucial to rethink the design practice, implement themes such as adaptation of the urban space, and mitigate the climate effects in a contextual path toward the decarbonization of cities. Specifically, the projects shown in the article displayed how regeneration could embody new ecological values, where the complementarity of nature and circularity exemplify the possibility for a spatial regeneration toward a new paradigm of urban ecology.

Rethinking the design action from a perspective of long-term resilience must be at the centre of the architectural debate; nevertheless, it is still unclear how the presented strategies could impact the form of the project, generating a proper transition of the design practice.

ACKNOWLEDGEMENTS

The present article is part of an ongoing doctoral research by Kevin Santus, mentored by Supervisors: Professor Ilaria Valente (Department of Architecture and Urban Studies) and Monica Lavagna (Department of Architecture, Built environment and Construction engineering), in Politecnico di Milano, AUID PhD course. The author thanks Agence d'architecture Thibaud Babled Architectes Urbanistes for the image of the project Ilot de l'Arc de Triomphe, which remain their property.

REFERENCES

- Amenta L., Qu L. 2020. "Experimenting with Circularity When Designing Contemporary Regions: Adaptation Strategies for more Resilient and Regenerative Metropolitan Areas of Amsterdam and Naples Developed" *University Studio Settings Sustainability*, 12, 4549; doi:10.3390/su12114549.
- Bertin, M., Maragno, D., and Musco, F. 2019. "Pianificare l'adattamento al cambiamento climatico come gestione di una macro-emergenza locale". *TERRITORIO* 89: 138-144.
- Brundtland, G. 1987. *Report of the World Commission on Environment and Development: Our Common Future*. United Nations General Assembly document A/42/427.
- Bulkeley, H. 2013. *Cities and climate change*. London: Routledge.
- Cheshire, D. 2016. *Building revolutions. Applying the circular economy to the built environment*. Newcastle upon Tyne: RIBA.
- Carson, R. 1962. *Silent spring*. Boston: Houghton Mifflin.
- Crutzen, P. 2000. Benvenuti nell'Antropocene. L'uomo ha cambiato il clima, la Terra entra in una nuova era. Milano: Mondadori.
- Dawson, A. 2019. *Extreme cities: the peril and promise of urban life in the age of climate change*. London ; New York: Verso.
- Frempton, K. 2011. "Urbanization and Its Discontents: Megaform and Sustainability". In Lee, S. (Eds.). *Aesthetics of Sustainable Architecture*. Rotterdam: 010 Publisher.
- Guo, D., and Huang, L., 2019. "The State of the Art of Material Flow Analysis Research Based on Construction and Demolition Waste Recycling and Disposal". *Buildings*, 9(10): 207. <https://doi.org/10.3390/buildings9100207>.
- Hagan, S. 2015. *Ecological Urbanism: The Nature of the City*. New York: Routledge.
- Hawken, P. 2017. *DRAWDOWN. The Most Comprehensive Plan Ever Proposed to Reverse Global Warming*. NY: Penguin Books.
- Hawkes, D., 2008. *The Environmental Imagination*. London: Spon Press.
- IPCC [Masson-Delmotte, V., P. Zhai, A. Pirani, S. L. Connors, C. Péan, S. Berger, N. Caud, Y. Chen, L. Goldfarb, M. I. Gomis, M. Huang, K. Leitzell, E. Lonnoy, J.B.R. Matthews, T. K. Maycock, T. Waterfield, O. Yelekçi, R. Yu and B. Zhou (eds.)]. 2021. *Climate Change 2021: The Physical Science Basis. Contribution of Working Group I to the Sixth Assessment Report of the Intergovernmental Panel on Climate Change*. Cambridge University Press.
- Kabisch, N., Korn, H., Stadler, J., Bonn, A. (eds). 2017. *Nature-Based Solutions to Climate Change Adaptation in Urban Areas: Linkages between Science, Policy and Practice*. London: Routledge.
- Lee, S. (Eds.). 2011. *Aesthetics of Sustainable Architecture*. Rotterdam: 010 Publisher.
- Meadows, Donella H. 1982. *The Limits to growth: a report for the Club of Rome's project on the predicament of mankind*. New York: Universe Books.
- Menonni, S. 2020. "Risk Mitigation and Resilience of Human settlement", in Balducci, A., Chiffi, D., Curci, F. (Eds.). *Risk and Resilience, Socio-Spatial and Environmental Challenges*. Milan: Polimi Springer Briefs.
- Musco, F., Fregolent, L. (Eds.). 2014. *Pianificazione urbanistica e clima urbano manuale per la riduzione dei fenomeni di isola di calore urbano*. Padova: Il poligrafo.
- Steffen, W., Broadgate, w., Deutsch, L., Gaffney, O. and Ludwig, C. 2015. "The trajectory of the Anthropocene: The Great Acceleration". *Anthropocene Review*, Vol. II: 1: 81-98.
- UNFCCC. 2015. *Paris Agreement Parties to the Paris Agreement*. United Nations Framework Convention on Climate Change. Bonn.
- United Nations. 2015. *Transforming our World: The 2030 Agenda for Sustainable Development*. United Nations.
- United Nations, Department of Economic and Social Affairs PD. 2014. *World urbanization prospects: the 2014 revision, Highlights*. (ST/ESA/SER.A/352).
- Vidler, A. 2010. "Whatever Happened to Ecology? John McHale and the Bucky Fuller Revival". *Architectural Design*, 208: 24-33

ENDNOTES

¹ More specifically, some notable documents to reference to are: the Strategic Research and Innovation Agenda (SRIA); The European Green Deal (European Commission 2019); COM 662, 2020 - A Renovation Wave for Europe - greening our buildings, creating jobs, improving lives (European Commission 2020); COM 98, 2020 - A new Circular Economy Action Plan. For a cleaner and more competitive Europe (European Commission 2020); COM 562, Stepping up Europe's 2030 climate ambition. Investing in a climate-neutral future for the benefit of our people (European Commission 2020); the international guidelines "Roadmap to 2050 A Manual for Nations to Decarbonize by Mid-Century".

Critical Explorations of Architecture Education in a Rapidly Changing World: Cross-Cultural Considerations of the Double-Edged Sword of Professional Competency and Global Citizenship

Brian R. Sinclair¹, Raffaello Furlan²

¹University of Calgary + sinclairstudio inc., Calgary, CANADA

²Qatar University, Doha, QATAR

ABSTRACT: Our world is in dynamic upheaval, in part reaction to interconnectedness and virtuality and in part response to escalating crises, including a global pandemic, climate change, unbridled politics, regional conflicts and seemingly broken moral compasses. Within this cyclone of change, architectural education struggles to equip students to cope with uncertainty and compete internationally. While in many ways, across countless jurisdictions, architectural education continues building upon conservative Ecole des Beaux Arts foundations, the authors suggest new modes of operation are crucial. The study, initially informed by authors' experiences in administration, leadership, teaching and research, critically examines Pedagogy, Process, and Product, in accredited architecture education, in Canada and Qatar. Understanding the status quo proves insufficient and inadequate, the research deploys methods to build understanding and shape redesign of curricula: critical examination of literature, comparative curricular analysis in two cases (Canadian + Qatar programs), and cross-cultural assessment of context, conditions, regulations, and aspirations. Research then builds upon analysis, guiding formulation of a new model for design education tackling dual-pronged goals of instilling professional awareness, skills and knowledge while shaping global citizens who understand complexity, are versed in cultural difference, and equipped with ethical knowhow. Daunting challenges of preparing capable professionals while shaping informed citizens prove urgent, timely and consequential. The research considers accreditation, relevant in North America and the Middle East, with such objectives in mind, questioning key curricular content including liberal arts, international affairs, emerging technologies, digital making, cultural qualities, and development of student world and self-views. The paper presents a series of views, speculations and provocations that serve as a springboard for a broader research agenda. The authors, drawing on their extensive administrative experience and research interpretations, propose a conceptual framework uniting disparate subjects and considering ethos of intense uncertainty, while transcending local focus. While local knowledge remains vital to equations of design, increasingly architects regardless of location must deploy evidence-based design, understand the ways of others, accommodate change, and be willing to assume, articulate, exercise, and defend their *modus operandi*.

KEYWORDS: Architecture, Education, Pedagogy, Ethics, Systems, Innovation, Holism

INTRODUCTION

"In the beginning, new ground must be carefully prepared; the old growth and underbrush removed; the soil tilled and raked; seeds planted; fertilizer spread; water provided in adequate amounts; while the sun provides ultraviolet and infrared rays creating a warm environment. When all this has been done through long hours of labor and required intervals of germination, a new young tree emerges. Eventually this young tree will bear fruit to reward those who have labored in the vineyard. It would be foolish to chide those who are preparing the soil and planting the seed because there is yet no fruit. It would be unwise to water too much or allow the sun to parch the land. When the time has come, the fruit will be ripe and its substance will sustain those who harvest it. So it is with knowledge."
Eberhard, 2007ⁱ

Our modern ethos, both locally and globally, encounters rapid change, mounting pressures, and growing uncertainty and unpredictability. While in past eras there was a sense of certainty and stability, in part due to comprehensible levels of progress, today the realities are far different: flux is turbulent, growth is dramatic, and assaults are incessant. Of course, avoiding nostalgic posturing, not all these shifts have been negative or limiting. In fact, many of the societal shifts have been encouraging and inspiring, including heightened awareness around social + spatial justice, design equity, demographic diversity, tolerance, and inclusion. That said, there are of course many troubling trends that give us pause to consider our trajectories and the implications of our actions in both the short and longer terms. While on one hand global civilization leaps forward in realms such as technological inventions and medical advancements, on the other hand many regressive moves and disturbing directions seem apparent. Complexity is overwhelming and the scale of crises (often catastrophes) proves incomprehensible. Rising seas of data and tsunamis of information do not automatically equate to growing knowledge and greater wisdom.

In fact, the erosion of common sense and the degradation of understanding frequently seems real, dispiriting and disconcerting.

Into this rich *mélange* falls higher education, charged with the nurturing of future generations, the inculcation of expertise, the building of skills, the production of knowledge, the development of leadership and, hopefully, the cultivation of civil behavior. In a world where right and wrong become increasingly nebulous terms, higher education needs to provide guidance to future citizens who stand to inherit a profound, difficult, and threatening mess. While we commonly focus on skills before knowledge, and knowledge before wisdom, the tide must turn. The authors define wisdom as the coupling of head and heart. Universities, and their constituent programs, too commonly preference the head over the heart -- finding comfort and safety in the readily quantifiable, the quickly countable, and the overtly rational. However, the real leaps concerning our contemporary conditions, and advancement on our human journey, will come more readily and with greater impact only if we can bridge to the other side -- namely, a conscious embrace of the more qualitative, the less calculated, the more emotional, the more intuitive and the more subjective. Clearly the formula we espouse is not an either/or proposition but rather a both/and necessity. The modern mantra states, "If you can't count it, it doesn't count." Such a narrow perspective has, in many ways, ushered in our present era of dilemma and disaster. Endemic fragmentation and heightened specialization have, undeniably and paradoxically, contributed to our inability to address modern problems easily and effectively. For example, while computational technologies have brought us great powers and introduced unimaginable capabilities, they have also contributed to an exponential burgeoning of often unmanageable problems (e.g., disinformation, predatory action, conspiracy theories, etc.). Considering this quagmire, it is vital to interrogate the mandates and methods of higher education, and to critically question the potential of the academy to right the ship. Universities hold positions of extraordinary privilege in societies around the globe -- with power and privilege comes responsibilities and accountabilities. When one wields exceptional force, as individuals and as institutions, the hope is that such might is used to realize progress, success, betterment, justice, enlightenment, and the like.

Embedded within higher education, and the central focus of the present paper, is architectural education. While humankind has in perpetuity sought shelter, only in recent centuries has the knowledge of design and construction migrated to institutions of higher learning. Shifting from the sanctum of the guilds to the classrooms of universities, architectural education has evolved to address and manage the growing technical demands of building. This path of formalizing education has been rich and productive. Enshrining professional competency in statutes and legislation has afforded society protections needed for user health, safety, and welfare. Education, in response, has increasingly responded to demands and expectation inherent to self-governing professions, including architecture. In many ways the means to reconcile education and practice was through standardization and accreditation. Across the planet schools of architecture have sought, and subscribed to, rigorous ways of fostering quality, consistency, and efficacy in their curriculum. Debates have raged around the levels of standardization that are appropriate, reasonable, and effective. Over time the pendulum has swung back & forth from more liberal education to more technical training, and from more interdisciplinary posturing to more discipline-specific emphasis. The world, especially since the millennium, has transformed in dramatic ways and to unforeseen degrees. The present paper critically considers the state of affairs in architectural education, viewed through two distinct lenses based on culture, context, geography, and philosophy. It presents a series of positions developed by the authors and informed by research, experience, and argumentation.

2.0 DELIMITING THE APPROACH

Architectural education is very complex, bringing together an array of learning objectives while ultimately endeavouring to prepare graduates to enter the marketplace to pursue careers in the design professions, the construction industry, and associated fields. The present paper provides an account of the opening phase of a longer term, multi-faceted study of education in light of prevailing pressures and emergent forces. As such it is preliminary in scope and only moderate in depth, relying on available information. Future phases will include surveys, interviews, focus groups and more detailed analyses of policies, procedures, and principles across multiple global regions. For the purposes of this initial exploration the focus was placed on two regions and countries therein -- namely, North America with the case of Canada, and the Middle East with the case of Qatar.

2.1. Goals

As an exploratory project, the research was concerned most fundamentally with scanning the landscape of architectural education in two particular cases, with interpretation informed by an understanding of the parameters and forces in society that influence and shape behavior (e.g., individual, collective, political, legal, etc.). The goals for the present study were:

- Build awareness of societal forces to which architectural education should be reacting and responding;
- Critically consider the strengths and weaknesses of architectural education in light of such awareness;
- Develop a model (i.e., roadmap to competency) for guiding architectural education in a manner which synergizes with societal needs + expectations.

2.2. Research Methods

The current project comprises a pilot exploration deploying qualitative measures to illuminate dimensions and characteristics of a changing society, and of architectural education in arguable need of change, to better guide and structure future study in this area. It is an initial series of probes, scans, and speculations intent on shaping a larger and longer cross-cultural study of architectural education. While the authors come from very different countries, contexts, and circumstances, they share common experiences, pedagogical posturing, and administrative acumen. The methods utilized in the present study were:

- Critical examination of literature pertaining to the big issues facing modern society (e.g., keywords such as climate change, social upheaval, public health, economic recession, social inequity, etc.);
- Comparative analysis of architectural curricula at selected schools in Canada and Qatar;
- Case studies of context, culture, regulations, and conditions prevailing in Canada and Qatar;
- Logical argumentation in the interpretation of the relevance of big societal issues to current architectural curricula;
- Synthesis, Inductive Thinking and Design of a Conceptual Framework for advancing architectural education.

2.3. Structure and Anticipated Outcomes

The present paper includes a summary of research into societal issues, followed by brief considerations of the cases of Canada and Qatar, and then culminates in the authors' Conceptual Framework. While the initial deliverables arising from the paper comprise a base understanding of society, curriculum, and a frame to bridge the two, the longer term impacts include the reform of architectural education (addressing robust and resilient pedagogy, reform of accreditation regimes, and the more potent preparation of graduates for practice and leadership in a changing profession, a transforming market, and a very different world).

3.0 DELINEATING THE CHALLENGES

“We perceive atmosphere through our emotional sensibility - a form of perception that works incredibly quickly, and which we humans evidently need to survive. Not every situation grants us time to make up our minds on whether or not we like something or whether we might be better heading off in the opposite direction. Something inside us tells us an enormous amount straight away.”

Zumthor, 2010 ⁱⁱ

A high-level scan of the literature around key issues revealed a rapidly escalating milieu of change -- one that is turbulent, unpredictable and, in many ways, disconcerting and often frightening. In this section of the paper some of the more pressing and critical issues are presented.

3.1 Society

Over past decades societies around the globe have been rapidly transforming, in many ways in worrisome directions. The implications of escalating greenhouse gas emissions are well known, including of course global warming and climate change. Architects, and the associated building sector, have been major players in this environmental deterioration. Without question, architects must now play a key role in righting the wrongs and in moving from destruction to regeneration. Social unrest is another vital issue with many connections to architecture, planning and the phenomena of cities. In many countries the gaps between rich and poor are widening, with more people sliding into poverty and despair. Over much of the past century architects had limited impact on the lower ends of the income spectrum, with much of professional pursuits aimed at those with power and resources. In other words, the architectural profession was deemed to be providing luxury services, as opposed to the essential services rendered by other professions such as medicine and law. Given the gravity of environmental decline and the escalation of social inequity, architects moving forward need to nudge the needle from luxury towards essential services. Also of great significance is public and population health. Connections between the environment and health was thrown into the spotlight through the arrival of the global pandemic. It is no longer tenable for the architecture profession to turn a blind eye to the physical determinants of health. In fact, the pandemic has served to underscore the tremendous potential of design to foster wellness (physiological, mental, sociological, spiritual, and so forth) and to combat infectious disease (including water and airborne agents). The authors have written on the need for, and value in, comprehensive greenspaces & landscapes in cities as compelling catalysts for health and wellness gains. Without question modern society is in turmoil, with few moments of brightness on the horizon. That said, higher education presents a remarkable opportunity to face incomprehensible problems head on, and the prepare and equip next generations of leaders who can survive and thrive despite the bleak outlook.

3.2. Context, Culture, Hegemony and Place

While the literature review illuminated many large-scale and overwhelming challenges facing the planet, it also revealed many moments of hope, beauty, and brightness at local levels. However, in many ways even local ways are under threat, with pressures to standardize, generalize and work to lowest common denominators. In this regard, architects have key roles to play in reinforcing the uniqueness of place. The onslaught of hegemony is tough to tackle, and hard to counter. Products are pervasive, consumerism is rampant, greed is widespread, and the extraordinary is giving way to the commonplace. At the local level there remains cultural nuance that is essential to harness, preserve and promote.

It is not, however, always clear who are the shepherds of such cultural richness and guardians of local personality. In some ways, due to the presence and potency of the built environment, architects are positioned to advance the cause and keep the character. Psychologists refer to the phenomena of place-attachment and place-identity. We shape the environment and it in turn shapes us. The places where we live matter intensely with respect to who we are, what we believe and how we feel. Place is space imbued with meaning. Meaning and memories, in many cases, make city dwelling magical. Even in areas fraught with conflict, or faced with devastation, place matters. Informal settlements, for example, despite their dire physical circumstances often have strong community bonds and networks of support that are remarkable. The human spirit is resilient. As architects it is crucial to understand such dimensions of living and dwelling, including how design efforts can reinforce health, happiness, hope and promise.

3.3. Complexity + Systems

A part of the path to our contemporary quagmire was realized through intense fragmentation, endemic separation, and the erosion of holism. In earlier times problems were far more localized, far more comprehensible, and, in many respects, far more manageable. For many reasons, including most notably advances in technology, our world has been rendered smaller while our troubles have been made larger. Communication is faster. Loneliness is heightened. Mobility is greater. Stability is weakened. Sharing is easier. Misinformation is pervasive. Due to the compartmentalization of knowledge, people, disciplines, and so forth, problems grow in complexity and difficulties build in consequence. Our scan of the literature highlights problems with jargon, accountability, civility, legibility and even right versus wrong. Our world is overflowing with data and information yet faltering with knowledge and diminishing in wisdom. For sure the situation is daunting and perplexing. One remedy that is commonly noted is to pivot from fragmentation to integration. By this we mean a shift to systems thinking in an effort to both problem seek and problem solve. Many recent human-made disasters have come at the hands of highly competent professionals deploying state of the art technologies. That said, in an ethos of fragmentation the left hand fails to grasp what the right hand is doing. Modern problems are unfathomably complex, and as such warrant unreserved and intense efforts to connect the dots and piece together the puzzle. Most certainly this charge is not to a given profession, but rather necessitates a rich interdisciplinary approach to realize progress and success. It is interesting to note that many institutions in the western world, including universities, are parsed into discrete disciplines and bounded fields. However, to solve many contemporary crises such walls must drop -- permitting a creative collision of ways of seeing, thinking, and acting.

3.4. Values and Trajectory

In times of confusion, and a lack of moral clarity, there are compelling reasons to critically examine how society, and individuals therein, navigate waters of change. Recent disruptions to governance structures, and unrest within civil society, across the globe call into question the roles of higher education as commentator, as researcher, as teacher, as leader, and as reagent for constructive reform and positive change. The authors contend that such roles prove imperative at the present juncture -- the ways we educate students, and our efficacy in instilling values, developing skills, and inculcating wisdom now will determine our situations downstream. The present research aims to take a first step at understanding the conditions in place, good and bad, and to chart a path forward that better prepares architecture graduates to take the reins, welcome risk and assertively pursue better buildings, healthier spaces, nurturing communities, and higher quality of life (QoL).

4.0 EXPLORING THE CASES

In this opening stage of the research two regions were considered from a cross-cultural viewpoint -- North America and the Middle East. Within these areas Canada and Qatar were studied, with an objective to gain insights into the character of the countries and the nature of architectural education. It was accepted that these two cases differed in many ways, and in some instances to significant degrees. That said, there was also an understanding that examining distinct cases could shed light into facets that are shared and facets that vary. It was also deemed valuable to seek common ground, as pertains the need for reform in curricular and other academic spheres, that arguably transcend culture, context, geography, and philosophy. The following narratives describe some basic features of architectural education for the investigated two cases.

4.1. Canada

Architectural education in Canada, for all 14 accredited schools in the nation, is offered only at the graduate level -- there is a single accepted degree nomenclature of 'Master of Architecture' (M.Arch.). While there is a range of approaches to the delivery of the degree, all schools subscribe to a single accreditation regime administered by the Canadian Architectural Certification Board (CACB). The criteria for accreditation are stringent and the assessment of compliance is rigorous. Across the range of schools there are many shared qualities due to the imposition of accreditation, and an overall high level of curricular development and delivery. Arguably there is sufficient latitude within the accreditation system, such as liberal arts content provisions, to ensure each school can develop its own personality and areas of specialization or concentration.

4.2. Qatar

Architectural education in Qatar is offered via the undergraduate degree, with the degree nomenclature ‘Bachelor of Architecture’ (B.Arch). The arrival of architectural education to the country is relatively new, with curricular development following American models, and with a modified accreditation regime (International Certification) based on the National Architectural Accreditation Board (NAAB) model. It is noted that in the USA, a range of degree nomenclatures fall under the NAAB purview -- for example, B.Arch., M.Arch. and D.Arch. In Qatar the B.Arch. accreditation process, while novel, guides curricular develop and delivery, with formal adjudication based on procedures following in the accreditation of American programs.

5.0 CONCEIVING THE FRAMEWORK

“We must take on the work of facing our fears, opening to intimacy and vulnerability, and opening to the unknown, to surprise. We can learn to open to situations simply, without aggression or defensiveness, and open to the inside as well; the depths beyond the surfaces of all life.”
Glazer, 1999 ⁱⁱⁱ

It is apparent that architectural education is, in many ways and across jurisdictions, unique, innovative, and effective. The studio, in particular, proves a potent pedagogical vehicle that equips students with the means to tackle very complex ‘wicked’ problems. In both the Canadian and Qatar cases, studio resides at the heart of the pedagogy and serves, quite effectively as the nexus for knowledge assimilation and application. In this way architectural education is an exemplar within the landscape of higher education. That said, changes in society, at all levels, are proving overwhelming, difficult and at times intensely troubling. Climate change, social inequality, and public health all stand as exceptional examples of emergencies in need of great ingenuity, understanding and resolve. While it can be argued that architectural education, and architectural practice beyond, has limited capacity to change the world -- approaching existential problems in a defeatist manner seems weak, worn, and waylaid. Instead, in the eyes of the researchers, architectural education must be reconsidered, reset, and redesigned considering shifting situations. Building from the literature reviews, considerations of global cases (North America | Canada + Middle East | Qatar), comparison of curricula + accreditation regimes, and deploying logical argumentation, the researchers proffer a conceptual framework to shape pedagogical reform.

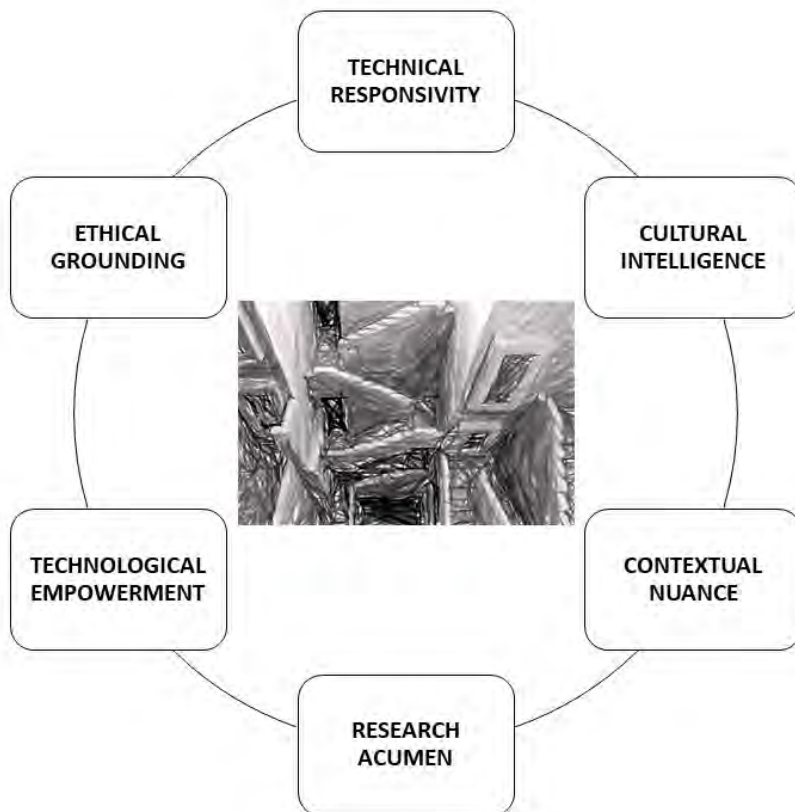

Figure 1. Conceptual Framework for Architectural Education Reset and Reform (Sinclair + Furlan 2022)

5.1 Technical Responsivity

While there have been great strides realized concerning international standards in construction (e.g., International Building Code), there remains a great need for situational responses based on climate, infrastructure, materials, oversight, etc. For example, Canada encounters intensely cold winter temperatures - which can be prolonged, damaging, and dangerous. The need for building design to respond to, and protect against, such extreme weather is profound. Conversely, Qatar sees intensely hot summer temperatures, which can prove as prolonged, damaging, and dangerous as the aforesaid Canadian winter scenario. It is important to underscore that students need training in international standards and practices in addition to being versed on local approaches and responses. Students with increasing frequency study abroad and then work abroad after graduation. Gone are the days when students work only in their home city, country, or region. Another good example of vital technological knowledge pertains to seismic design -- regardless of geological stability at home, it is critical for students to understand that some regions demand greater attention to seismic activity and deeper understanding of implications to building design. Also vital to address moving forward, in the realm of the technical, are emergent capacities around modularity, pre-fabrication, in-situ assembly/disassembly, flexibility and agility. The need for architecture to be mutable and responsive is no longer a point of debate -- sustainability concerns dictate a shift away from the static and fixed.

5.2 Cultural Intelligence

In earlier eras, when mobility was more restricted and communication more limited, nations were far more isolated and monolithic. Demographics were commonly homogenous and diversity, seen from multiple lenses, was constrained. Today, in contrast, the world is transforming in outstanding ways, with all countries encountering dramatic shifts in composition and character, in part through migration and in part through the fluidity of global commerce, trade and exchange. Seen through architectural education and its curricula, students need far more awareness of and facility with cultural richness, cultural difference, and culturally sensitive design. Canada, for example, is notable for its tapestry of backgrounds, its plurality of people, and its posture as a nation of immigrants. Regardless of location within Canada, architecture students must be able to design for diversity. Qatar, within its citizenry, is far narrower than many nations. That said, the country has a large and diverse expatriate population, drawing a workforce from around the globe. Students of architecture in this Gulf Region nation must be aware of the need to design to meaningfully accommodate people with different values, traditions, lifestyles and needs. The authors argue that regardless of location, whether Canada, Qatar or elsewhere, architectural education must introduce, cultivate and construct 'cultural intelligence' in students.

5.3 Contextual Nuance

A key dimension to design and planning of/in the built environment is context -- the situations and circumstances in which architecture is considered, conceived then constructed. While all schools incorporate courses that address site analysis, many schools arguably fall short in meaningfully considering the melange of forces and factors that define place. For example, human behaviour, environmental psychology, and cultural anthropology are often limited as knowledge areas within the curriculum. That said, and in the minds of the authors, our grasp of context must embrace far more than physical dimensions of the places in which we design. From a systems perspective the variables in place and at play are breathtakingly many and complex. Students need to consider not only the tangible or hard features that influence design, but critically the more intangible and soft qualities that shape who we are, how we interact, what we feel, etc. From a learning perspective this includes, of course, architectural programming. However, in today's demanding and moving milieu the knowledge imparted to architecture students must transcend site analysis and the program to also potently consider psychological, sociological, spiritual, legal, political, financial, and other dimensions that affect society and nuance situations. One of the key learning objectives in our schools, regardless of country, should be the education, development, and graduation of effective system thinkers.

5.4 Research Acumen

Societies around the globe are facing common pressures and shared expectations, propelled to act based on dwindling resources, the need for greater versatility, the demands for higher accountability, the urgency to reverse global warming, and so forth. As we are well aware, due to the gravity of global crises, there is no option for inaction. To this end, the production of architecture is increasingly under severe scrutiny with regard to such aspects as energy use, health impacts, financial viability, environmental effects, ability to be functionally modified, user accessibility (mobility, universal design, neurodiversity), etc. To meet such demands for responsibility and accountability, architects must operate on sound facts, robust knowledge, and indisputable evidence. Not only must students be educated in how to access and use the 'right' information, but they must also be trained in how to generate knowledge. In many schools there is limited curricular space afforded to research, including design, methods, development, and deployment. Architecture, as a discipline and profession, has an arguably shallow history of reliance on research, and especially when compared to other fields such as medicine, engineering, or law. For many students, and indeed for practitioners operating beyond the sphere of the university, there are limited contributions to and shallow reliance on peer-reviewed journals and other knowledge repositories. Students, in the authors' view, should be well-versed around research -- the generation of knowledge, the understanding of questions, the harnessing of findings, and the reliance on evidence

as fundamental to 'good' design. As we already witness, when the profession does not demand research acumen of its own accord, then clients, authorities with jurisdiction, the legal system, and others in positions of power and influence, will call for and demand accountability.

5.5 Technological Empowerment

Digital technology has had, and continues to have, profound impacts on higher learning, architectural education, the design & building sectors, and our world writ large. While the welcoming and embrace of computers and computation in the architecture business has been remarkable, less commendable has been our unwillingness, and perhaps inability, to critically interrogate impacts and implications of high technology on design outcomes. Plato explored the notion of the pharmakon, whereby a medicine is rendered as remedy or poison depending on application, politicization, etc. Digital technology is, of course, a pharmakon -- while it is undeniably capable of realizing positive change and improvements to our quality of life, it is also able to destabilize, prove destructive, and wreak havoc. In the view of the authors, the incorporation of digital tools and technologies within architectural curricula warrants a far more serious and consequential examination, especially in light of growing misinformation, weaponizing of knowledge, and unbridled reliance on computation as 'pervasive, infallible and all-knowing'. Without question advanced and emerging technologies hold remarkable promise to positively influence architecture and city building. That said, these same tools run the risk of negatively impacting our lives, and often in ways that are exceedingly difficult to quantify, characterize and contain. Consideration of the precautionary principle seems apropos.

5.6 Ethical Grounding

Overarching all components of our framework is the need to address ethics. Societies around the world are struggling to cope with shifting sands. While in earlier times there may have been more clarity, or at least greater shared understanding, around societal expectations, norms, and values, today there is a blurring of boundaries and growing uncertainties. While some indeterminacy, unpredictability, and uncertainty can be expected in eras and ethos of social upheaval, this lack of clarity raises the need for architectural education to wade more assertively into the debate. In previous times, where problems were arguably more bounded, society was less litigious, and cause + effect proved more legible, perhaps the education of architects could focus more on technical competency and less on philosophical, sociological, and ethical parameters of the profession, the industry, the environment, and civilization. However, it is now abundantly clear that ignoring such understanding is detrimental, unreasonable, and irresponsible. The authors contend that ethics, and the development of ethical ways of understanding and acting (the moral compass) is fundamental to architectural education in our contemporary times.

6.0 ANTICIPATING THE IMPACTS

Higher education is remarkable and commendable in many ways, not the least of which pertains to the ability of design to impact our world, including improving the built fabric, healing our natural environment, and raising quality of life positively and demonstrably. While many aspects of our education systems, and associated curricula (and notably accredited programs in architecture), have functioned well and have proven efficacious, the authors contend that structural and philosophical changes are urgently needed to better prepare students for a drastically shifting milieu and intensely uncertain future. Without question the profession of architecture is under pressure to respond to new conditions and react to unprecedented challenges. As is the case with many complex systems, professions can be slow to shift. We need to ensure we understand the changes underway, their root causes, and our options to act. Education of architects of course precedes professional practice, and as such has an overwhelming responsibility to anticipate change, grasp trends, and reform curricula to best equip students with the skills, knowledge, and values to succeed. And success, in today's turbulent and troubling times, cannot be measured merely on an individual basis but rather must aim for dramatic improvement system and society wide. While the present research is in its early phases, the aspirations of the authors is to build from the preliminary findings and understanding in an effort to influence and inspire educational reform. The issues delineated in the present paper are many, complex and intensely consequential. They will need meaningful discussion, exploration, and debate within both the academy and the profession. The conceptual framework developed through the current study is seen as a provocative starting point, and focus for, said conversations.

CONCLUSION + NEXT STEPS

"Equipped with the concept of heuristics and heuristic reasoning, we now can take up the task of identifying and attempting to elucidate the characteristic features of the problem-solving behavior of designers in action. Although a more phenomenological account may at times seem more appropriate to the spirit of design activity, a general adherence to the information processing paradigm of problem-solving theory will be maintained because of its breadth and precision."

Rowe, 1992 ^{iv}

Operating within an increasingly uncertain and unclear milieu is difficult. In nations around the planet, we see

destabilization, tensions, conflicts, and challenges at levels unanticipated and generally unwelcomed. It is difficult for us, at both individual and societal levels to understand how to react. Psychologists refer to the phenomena of 'learned helplessness', whereby being confronted with problems that seem unsolvable, or unchangeable, results in the giving up of hope. When people feel that they cannot influence a situation they will abandon efforts and direct energies + resources elsewhere. Architecture has been an undeniable player in several our planet's current crises. That said, design has unparalleled potential to act to good ends. Now is not the time for feeling helpless, disenfranchised, or disempowered. To the contrary, architectural education needs to seize the reins, develop relevant knowledge, instill leadership, and empower students to act. The present paper presented a series of pictures, preliminary in extent and speculative in direction, intent on characterizing global challenges, illuminating opportunities to problem solve, and conceptualizing an education ethos that could make a greater difference. The current research aimed to develop a frame and associated understanding that could inform and influence a broader and deeper cross-cultural study of architectural education, especially considering our perplexing and demanding times. The research engaged in a scan of the landscapes of design education with an eye to culling out key areas of impact and value, which should be addressed as reset and reforms are contemplated. It intentionally aimed to raise more questions that it answered and seeks to construct a base for future work that aspires to improve the ways we teach and learn about design. The goal for today was to grasp the gravity of our challenges and better understand possible next steps. The aspiration for tomorrow is to enact modifications to curricula, adjust program structures, and transform education in ways that more fully accommodate and more effectively address a rapidly changing globe.

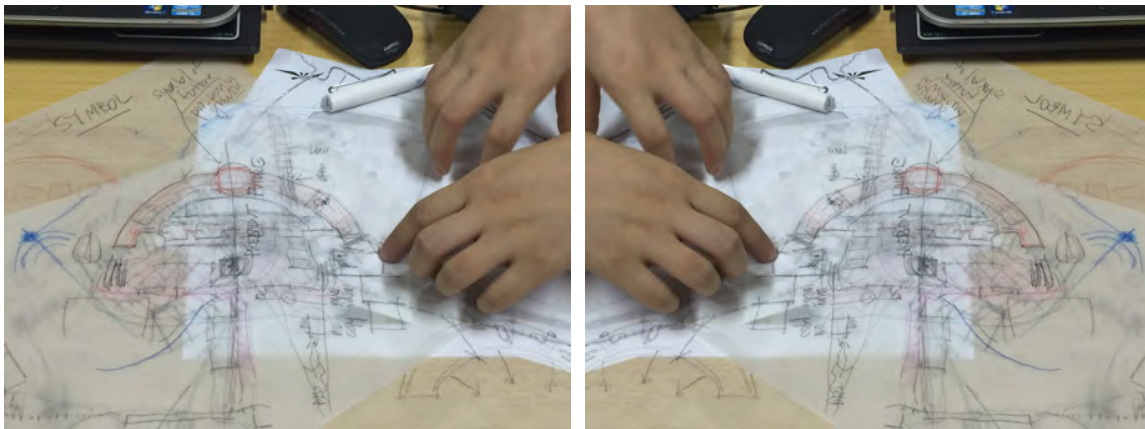

Figure 2. The Potency of Design and the Power of the Studio (Sinclair, 2022).

ⁱ Eberhard, John P. *Architecture and the Brain: A New Knowledge Base From Neuroscience*. Ostberg | Greenway Communications: Atlanta, GA. 2007. Page 19.

ⁱⁱ Zumthor, Peter. *Atmospheres*. Birkhauser: Basel, Switzerland. 2010. Page 13.

ⁱⁱⁱ Glazer, Steven (Editor). *The Heart of Learning: Spirituality in Education*. Penguin Putnam Inc.: New York, 1999. Page 247

^{iv} Rowe, Peter G. *Design Thinking*. MIT Press: Cambridge, MA. 1992. Page 91.

Water Resilience: Mapping and Active Borders as Instruments for Climate-Resilient Waterfront Design Strategies

Elena Verzella¹

¹University of Ferrara, Ferrara, ITALY

ABSTRACT: The recognized inefficiency of traditional defences against the water-related disasters foreseen by the scientific community on climate change (IPCC 2014) has led to the necessity of exploring innovative design approaches in coastal cities, accepting “some degree of flooding” and considering water not just as an external threat, but as a fundamental component of the design process. From this perspective, through a review of international case studies, the paper aims at defining an alternative design methodology, capable of developing possible urban and architectural strategies for climate-resilient waterfronts where the conflicting condition between flood protection and urban quality can finally be solved. The proposed methodology is based on three operative assumptions. The first one moves from the reinterpretation of the concept of “waterfront” as an “active border”. Indeed, waterfront areas cannot be anymore considered as a “boundary” (Sennet 2006), a hard separation between natural and built-up, neither can they become the space of irrational or uncontrolled urbanization. On the contrary, they need to be read as a “thick” edge that can operate both as a responsive and dynamic interface between land, built-up and water and as a hybrid infrastructure connecting different scales and uses into a synergistic system. Secondly, the “temporal component” is also integrated as an essential part of the design research. As waterfront areas are intrinsically evolving contexts, the research focuses on architectural and urban expressions which can accommodate different temporal phases and be consistent with additive, adaptive, and transformative logics as a response to external perturbations. Lastly, a different interpretation of the “mapping” activity is explored, intended not just as a “tracing” operation but as an active design process (Corner 1999), capable of bringing to light the inner relations among the components acting within the waterfront system and to translate them into innovative design opportunities.

KEYWORDS: Urban waterfronts, Operative key-concepts, Active border, Mapping, Temporal component

INTRODUCTION

Scientific reports have been repeatedly demonstrating the severe impacts that climate change will have upon urban settlements in the coming decades (Aerts & Botzen 2011; IPCC 2014; UNISDR 2015). In particular, urban waterfronts appear to be extremely affected by the effects of this phenomenon, being, on one side, physically the most exposed areas to short- and long-term water-related events such as sea-level rise, extreme rainfalls, storm surges, hurricanes, etc., and, on the other one, constantly under the pressure of further and more intense processes of economic and urban exploitation (Neumann et al. 2015; Nicholls & Cazenave 2010; Hallegatte, et al. 2013).

However, despite this intrinsic vulnerability, the analysis of the main morphological as well as economic, social and cultural transformations involving waterfront areas in the past decades have proved a high latent ability to adapt their built and spatial categories in tune with the always changing needs/ambitions of the related cities, becoming, on several occasions, even the trigger of city-scale regeneration processes (Marshall 2001; Hill 2007). Hence, a question arises: given the new challenges posed by the combination of climate change and socio-economic changes, how can we promote design pathways that can enhance this intrinsic transformability of urban waterfronts rather than hindering it? And, above all, how can we use this potential to make urban waterfront interventions an instrument to cope with upcoming climate threats and, at the same time, to make them still an opportunity to create an urban environment that reflects the contemporary ideas of society, culture and future development of a city?

1.0 “WATER RESILIENCE”: a necessary state for a future waterfront design paradigm

To answer the previous questions, it is necessary to reformulate the main waterfront design paradigms, rooting them into a conceptual ground where the apparently irreducible realms of flood risk protection and urban planning ambitions can coexist, but also enhance each other. This conceptual ground was therefore identified in the concept of “resilience”. According to the ecologist Crawford Stanley Holling, there exist two possible properties of a system during a stress event: “stability” and “resilience” (Holling 1973). “Stability” is defined as “the ability of a system to return to an equilibrium state after a temporary disturbance” (Holling 1973, 17); on the other hand, “resilience” is described as “the measure of the ability of these systems to absorb changes of state variables, driving variables, and parameters, and still persist”

(Holling 1973, 17). Bringing these properties into a more “urban” framework, it could be argued that the main measures currently applied to face natural disasters in waterfront areas (dikes, floodwalls, dams, ...) are conceived in order to guarantee the “stability” condition, where water is prevented, with all possible means, from coming in contact with the built and human environment. However, the increase of magnitude and frequency of water-related hazards has revealed the current (economic, urban and environmental) un-sustainability of these models and all their intrinsic limits. For this reason, it seems to be necessary to elaborate alternative design pathways, which are established on the more complex concept of “resilience”. However, how could this concept be actualized in the urban waterfront realm?

The first action is to reconceptualize the traditional idea of waterfront, starting exactly from the origins of this concept. A secular tradition of cartographers, hydrologists, engineers, and even urban planners has been representing water bodies as a continuous “line”, establishing, once and for all, what is supposed to be permanently “dry” and what permanently “wet” (da Cunha 2019). From this moment, two extremely different (and sometimes deeply disconnected) realms have been developing on the two sides of this line: the urban system on one hand, totally absorbed by the city’s expansion logics and safely protected by levees, dikes, and seawalls; and the water systems on the other, continuously channelled, dredged and reshaped to facilitate navigation and other water activities. However, it is from this same act of abstraction that suddenly also the idea of “flood” has originated, conceived as a deviation from this established and unanimously accepted artificial action. And, over time, the stronger the flood risk, the harder this separation line has become, with always higher and reinforced barriers (Mathur & da Cunha 2014).

Therefore, given the definition of resilience mentioned above, a possible pathway to create a resilient condition in urban waterfronts would be to “dissolve” this line into a more engaging transition between water and land. The traditional attitude of living *separated* from water needs, indeed, to be replaced with the idea of living and working *with* water, whereby urban dynamics and human activities are not imposed over but modulated on the water and its natural cycle. From this viewpoint, natural water level fluctuations as well as even more rare events such as storm surges or extreme river discharges would not be just exceptional situations against which only protection is required but become different equilibrium states of the same waterfront ecosystem: «The question is whether we should build faster and harder to keep it out, or find a way to gently merge ourselves with the water once again, transforming the hard boundary into a continuum, a smooth transition, a commingling rather than a battle zone» (Nordenson et al. 2010, p.13).

From a design perspective, this means that the design needs to involve water and the possibility of water not only as a context feature or a risk factor, but as an active and fundamental design component which informs, shapes, and steers the design choices, in a joint effort between different disciplines (architecture, urban planning and landscape) and scales. In other words, the design of the urban waterfront needs to be conceived as a combination of natural and artificial structures which can withstand but also tolerate or accommodate water in an always varying degree of approximation to it. The underlying design challenge is, therefore, to explore the different possibilities entailed by the “living with water” paradigm (such as living *near* the water, *in* the water or *on* the water) and ultimately to originate a system where a certain degree of “flooding” is not only accepted, but actually turns out to be a peculiar feature characterizing the identity of the waterfront space. In this way, the property of “absorbing disturbances and still persisting” required by the resilient system definition is not only satisfied, but potentially becomes a trigger to a wider process of urban regeneration and improvement of both public and private space.

2.0 ACTIVE BORDER, TEMPORAL COMPONENT AND MAPPING AS OPERATIVE KEY CONCEPTS FOR RESILIENT WATERFRONTS

The aforementioned necessity of incorporating the property of “resilience” into the traditional urban waterfronts raises the need of an alternative design methodology which can help to include these assumptions into a single and consistent design process. Therefore, the paper has identified three “operative key-concepts”: *active border*, *temporal component* and *mapping*. The importance of the latter lies in the fact that on one side they represent the *conceptual* framework through which to read and understand the waterfront system from a resilient perspective, while, on the other one, they are also conceived to be translated into operative design tools, becoming instruments to explore design propositions and enable the definition, application and combination of possible resilient strategies in more specific contexts.

2.1. Active border

The first operative key concept concerns the idea of urban waterfront as an “active border”. The starting point for the understanding and utilization of this key-concept is to retrieve the theoretical duality between “boundary/border” and reconceptualize the conventional urban waterfront interpretation from a “boundary”, a hard separation «where things end», to a “border”, a territory «where different actors interact» (Sennet 2006). If the boundaries are typically mono-dimensional entities, reading urban waterfronts as “boundaries” will lead to the same “lines-based” interpretation mentioned in the previous paragraph; on the contrary, assuming urban waterfronts as a “border” enables to exponentially expand this dimension into a “thick edge” and create that liminal space that is not a barrier between antagonist characters, but rather a threshold between two components that are actually part of the same organism (Bergdoll 2011). In this way, not only does the urban waterfront become the terrain of coexistence of (traditionally) opposite realms, but even the place to promote the *interaction* between water/land, build/unbuilt, natural/artificial. In this sense, the “border” becomes “active”, since it does not give protection by passively preventing from any type of

contact between water and urban settlements in case of a climate event (such as several conventional defences), but, on the contrary, it is capable of both absorbing or mitigating through its (natural, urban or architectural) structures the magnitude of extreme climate events and adapting its components and their uses according to the different external conditions. As a result, from this design perspective flood protection in urban environments is not addressed anymore by a single “wall” (such as in several highly dense urban contexts, which dramatically hinders the traditional link between waterfronts and water) nor by cities’ environmental “free zones” which, despite being designed to accommodate natural and temporary expansions of water bodies, are still regulated to prevent from any type of urbanization or utilization, representing, at the end, another barrier (even if natural) between water and urban realms. On the contrary, through the “active border” paradigm flood protection is extended to the whole space of the waterfront, in an urban system that combines rather than impedes the development of new activities which can positively engage with the presence of water and, consequently, enhance the attractiveness and value of the area.

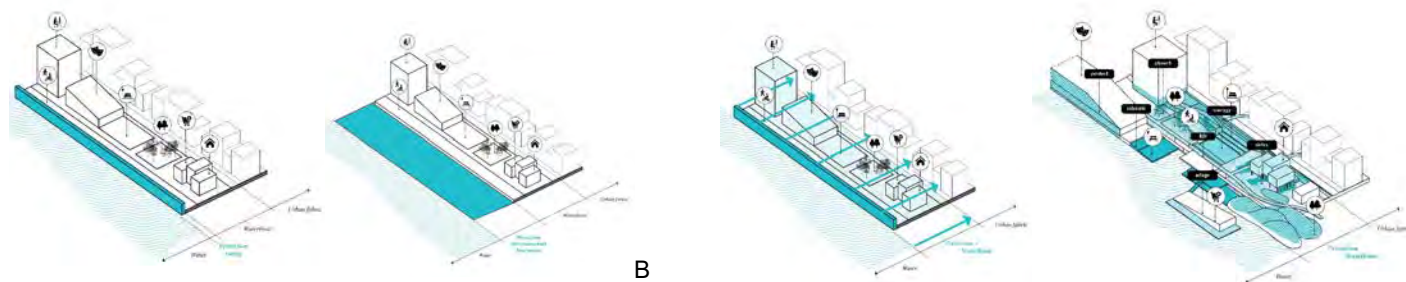

Figure 1: Comparison between traditional flood protection systems (A) e new design paradigms (B). Source: Author 2021.

From this primary assumption, the following implications of the “active border” can be deduced:

- the “active border” has an *undefined character* (Clémant 2004). As mentioned before, the notion of “active border” conceptually allows the possibility of different states (wet and dry) within the same system, determining a transitional landscape where it is not possible any more to precisely identify the traditional definitions of the urban and the water paradigms. On the contrary, a progressive “blurring” of any notion of edge is generated: water enters in what is conventionally deemed the “urban realm” as well as urban structures expand towards water. This originates an “aqueous” urban landscape which, despite this intrinsic undefined character, can generate a very strong identity, allowing to read the waterfront as a specific, new, urban category.
- the “active border” is based on *diversity*. The waterfront as an active border is *physically* diverse since it can be articulated in different forms such as natural systems (like absorptive wetlands, tidal parks, berms, artificial islands, ...) and built ones (buildings, landform buildings, piers, quays, floating platforms, ...). This diversity not only improves the urban quality and attractiveness of the space, but it can actually enhance the adaptive behaviour of the urban waterfront in case of a climate event. The combination of different structures, indeed, enables to achieve some fundamental properties of a resilient system such as “redundancy” and “resourcefulness”(Nazif, Mohammadpour & Eslamian 2021): instead of relying on a singular type of protection response in case of a climate event (as in many types of traditional flood protection systems), the diversity of the components of the “active border” can deploy a wider range of counteraction typologies (essential if we consider the uncertainty of future consequences of climate change) as well as guarantee protection even if one actor/element of the system temporary fails. Additionally, the diversity of the “active border” is also represented by a strong *programme diversity*. The necessity of a multifunctional character especially in waterfront redevelopments has been analysed several times and recognized as a way to foster connections, aggregation, leisure, nature and culture as well as to guarantee a profitable cooperation between public and private (Bruttomesso 2001). However, this diversity in functions can also become an opportunity in terms of resilience against flood threats since it in turn increases the possibility of exploration of innovative flood protection measures that can be combined with the development of new activities related to the water (such as recreational and cultural spaces, natural areas, research activities, food production, energy production, ...) which, ultimately, also exponentially enhance the urban value of the area instead of undermining it.
- the “active border” can work as *hybrid infrastructure*. The benefits that a transitional environment might entail also concern the development of the natural ecosystem of the urban waterfront. The positive contribution of organisms such as mangroves, algae, molluscs, etc. in the reduction of effects of water-related threats (absorption of water, coastal erosion, reduction of waves energy, ...) can foster processes of restoration/implementation of natural systems such as wetlands, natural reefs, mudflats, and marshes. This can lead to the creation of an ecological infrastructure, which will work both as a biodiversity refuge, recreation facility, protection buffer against climate change and, ultimately, also as a trigger for the implementation of alternative slow mobility networks (such as cyclo-pedestrian paths). In particular, innovative water-based transportation systems can be developed, with ferries and boats and intermodal hubs. This aspect not only improves the connection between the different components along the waterfronts (Nordenson 2009), but also (and more importantly) strengthens the perception of water not as a limit of the urban space, but just as a different “shape” of it (Shannon & Smets 2010).

From the operational perspective, the notion of “active border” is translated into the design of a sequence of architectural, urban and landscape episodes that incorporate the qualities described above and develop a different degree of interaction with water. An overview of the possible interpretations of this concept could be provided by the analysis of some of the design proposals presented at the exhibition *Rising Currents: Projects for New York’s Waterfront*, an initiative organized by the Museum of Modern Art and P.S.1 Contemporary Art Centre in New York and curated by Barry Bergdoll (24th March – 11th October 2010). The purpose of the exposition was to analyse the effects of climate change on the New York and New Jersey’s Upper Bay waterfronts and develop solutions able to transform phenomena like sea level rise and storm surges from threats to opportunities for reorienting the perception and the experience of the city around water. In almost all the proposals, the notion of the “active border” plays a fundamental role. In *New Aqueous City*, the proposal elaborated by nARCHITECTS for the south part of the bay, the traditional division between land and sea is almost totally denied in favour of a smoother and gradual transition between these two realms: the urban grid is indeed extended towards the water through wave-attenuating piers, which not only constitute a memory of the past harbour character, but also represent a support structure for ferry stations, public leisure areas, protected wetlands and even innovative residential building settlements hung from shared bridge structures; finally, land is stretched till open water through an archipelago of man-made island connected by inflatable storm barrier which will ensure protection in the event of a storm surge but will also provide space for the development of new natural (or even human) habitats. On the other side, water is brought inside the urban fabric, through infiltration basins, bioswales and culverts which usually work as green-blue public spaces, improving the quality of the area, but can absorb and store water runoff during storm events.

The same approach but in a more ecological perspective is adopted in the proposal *New Urban Ground* by ARO for the Lower Manhattan site. Here, the waterfront is designed as a continuous green infrastructure made of saltwater and freshwater wetlands that actively and dynamically interact with daily water level variations as well as during high water occasional extreme weather situations. This infrastructure relates to the existing urban edge in different ways, both accreting it (through land reclamation, creating natural protection ridges parallel to the shore) or carving it (obtaining shallow waters and transition areas), until it lastly dissolves into a more scattered system of sediment-filled constructed islands which act as natural breakwaters against waves in the highly exposed Lower Manhattan area.

Lastly, the complexity of the “active border” can also be found in the proposal *Water Proving Ground* made by LTL Architects for Liberty State Park and Ellis Island. In this project, the waterfront does not exist anymore as a solid entity, but it frays into a completely different landscape of hard and soft edges, higher grounds, gradual slopes, and water channels which actively embrace tidal fluctuation as a main identity feature. Moreover, the design investigates urban and architectural expressions that are not only prepared to bear variable water levels (waterproof buildings, suspended paths, tidal parks, “water amphitheatre” with floating stage, ...) but also promote the flourishing of a wide range of new urban activities deeply connected with the cyclical presence/absence of water (agriculture, water recreation, culture, protected natural areas, aquaculture research centre, hydrological testing facilities, ...) exponentially expanding the economic, social and cultural opportunities related to the waterfront environment.

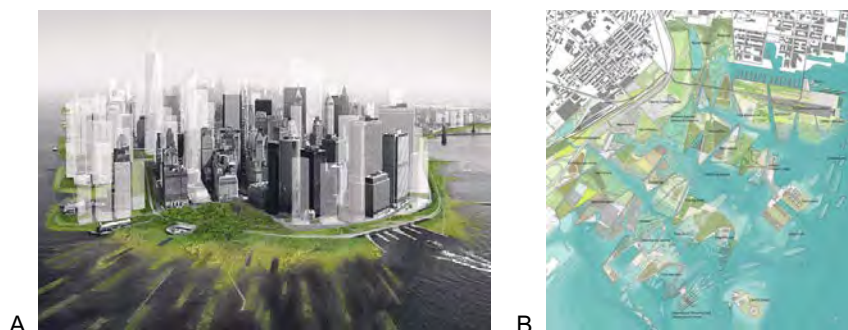

Figure 2: *New Urban Ground* (A) and *Water Proving Ground* (B) proposals. Source: Bergdoll, 2011.

2.2. Temporal component

As previously described, one of the main features of the “active border” concept is its “undefined” nature. However, this “undefinition” does not exhaust only in a vagueness of spatial structures or blurred boundaries between the water and urban spaces but multiplies its potential if conceived also in a temporal perspective. Additionally, the “active border” had been defined as fertile terrain for the dynamic interactions between these two realms; still, the idea of “interaction” intrinsically assumes the existence of a temporal dimension that determines the modalities, the actors and the duration through which this exchange act between different realities unfolds.

Therefore, the second operative key concept is focused on exploring the “temporal” extension of the waterfront design process both as a prerogative and instrument to create resilience. One of the main objectives of traditional design processes is the immutable persistence (both in terms of morphologies and functionalities) of the design products over time, almost as if the quality of the latter was assessed according to their capability of preserving their propositions

regardless of the external influences. However, in the framework of urban waterfronts, an approach of this sort may result in an over-constraining of the potential adaptive character of these areas. Especially when considering urban waterfronts as ecosystems (Corner 2006), the traditional anthropocentric attitude which tries to restrict an evolving reality into a pre-ordinated fixed scheme appears more and more inapplicable. On the contrary, the idea is to read (and live) the urban waterfront space through the lens of time, as a living environment that assumes different shapes and opens to multiple scenarios following the inputs of the external world. For this reason, the design should actually promote the characteristic temporal dynamicity of the components of waterfront areas and their interactions, including temporality already into the design process. This means that the output of the design should not be a particular urban or architectural form but rather a more complex set of possible states which can temporally evolve one into the other. In this sense, the idea of time assumes a twofold extension, both intended as physical transformation of the waterfront structures over time and as a variation of their perception by people who happen to enter in contact with them: the alternance between absence/presence of water or the continuous variation of water levels, indeed, can become a tool to dynamically shape the space in an always changing urban landscape, which can resiliently respond to climate stresses as well as actively involve people to harmoniously experience the dynamics of the water environment.

In order to incorporate “time” into the design process of urban waterfronts, the following pathways have been identified: 1) *the acceptance (and design) of different appearances and uses of urban and architectural structures over the time*. In this sense, “time” is intended not in its linear interpretation, but rather as a summary of different “moments of water”, which include daily or seasonal water fluctuations as well as high levels during “punctual” extreme weather events or long-term permanent transformations due to the climate change impacts. As mentioned in the previous paragraphs, a possible way to achieve resilience within the waterfront system is to allow a certain degree of water. This approach implies the distinction of spaces that need to stay dry (primary infrastructures, health facilities, power utilities, etc.) and spaces that, on the contrary, will be let partially flooded under specific conditions. The latter, therefore, need to be designed from a very broad spectrum of different degrees of interaction with water. From this perspective, public spaces offer great opportunities to be developed according to a temporal dimension (Matos Silva & Costa 2017). Through stepped squares, labyrinthic playgrounds, undulated profiles, they are shaped to accommodate water in order to “shape” water afterwards as an opportunity before than a threat. In this way, not only will these spaces be able to tolerate and accommodate excessive water, but also contribute to the flourishing of new activities connected to the (temporary) presence of water and, ultimately, increase the quality and the identity of the urban environment.

An interesting example of this logic can be represented by the study carried out by the Dutch firm De Urbanisten on the concept of the “water squares” (Boer, Jorritsma, van Peijpe 2010). Despite not being directly addressed to the waterfront context, this research highlights an extremely insightful vision of possible relationships between urban space, time and water. Developed during the IABR exhibition *The Flood* (2005) as a part of a wider climate adaptation vision for the city of Rotterdam (NL), the target of this concept was to address the issue of water storage in highly dense urban contexts as a response to extreme weather events driven by climate change. As the name may suggest, they try to envision design solutions, mainly belonging to the public space realm, able not only to collect, but also to change according to the external stresses. Through the manipulation and reinterpretation of the traditional public space components (street furniture and pavements, squares, playgrounds, gardens etc...), the idea is the creation of a space which is dry for most of the year, allowing the carrying out of recreational and collective activities, but, in case of heavy rainfalls, it could be easily turned into a water storage facility, temporarily reducing the water pressure of the city’s drainage system. Following this logic, several urban expressions were then developed: sloped or stepped squares that can be used as a tribune for events or performances or sports arenas in dry days and catchment facility during wet ones; street furniture that works as a temporary dam or corrugated street pavement to slow down the runoff of rainwater; floating square floors or grassy fields, which move up and down according to the amount of water stored underneath; sponge or inflatable furniture, which grows and shrink based on how much water it contains during a specific moment of the day. The special character of these urban and architectural solutions lies exactly in the fact that each of them is already conceived and shaped from different time perspectives during the design phase, resulting in a temporally dynamic urban landscape that changes according to the presence (or absence) of water, and, above all, that embrace water as a tool to develop new and further uses and perceptions of the public spaces in relation to the different weather conditions. As many realised examples demonstrate (such as Bentemplein 2011-2013, Bellamyplein, 2012), this concept has strongly succeeded in integrating water management in the case of extreme climate events with the improvement of the quality of the urban public space and the identity of local neighbourhoods.

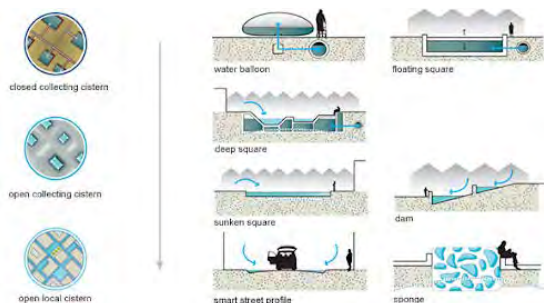

Figure 3: Different examples of “water squares”. Source: Boer & at. 2010.

2) *the exploration of architectural and urban expressions compatible with additive and incremental logics.* Besides the idea of temporarily allowing water in the “urban realm” as a result of both natural processes or extreme climate events, recognizing the “temporal dimension” of the waterfront design means to prepare urban and architectural manifestations to “flow” along with the flow of time also in a long-term perspective. As already mentioned, the effects of climate change in the coming decades are still uncertain. For this reason, it is necessary to conceive the urban waterfront as a system that can be upgraded and developed in different phases over time, to respond to the always changing safety and urban demands. From this perspective, the elements of the waterfront are designed to be consistent with transformative and incremental patterns of long-term development which, far from converting the waterfront into the terrain of further and indiscriminate urbanization, will align the upcoming flood protection needs with the future urban ambitions, in order to achieve safe spaces without compromising neither the intrinsic multifunctionality and (physical, visual and social) accessibility of the waterfront nor its urban quality: in the long run, parks and green areas are designed in a way that they might be either reshaped as protective berms or further carved to allocate more water; public space can expand and develop into protective pavilions or community buildings; as well as more traditional defence infrastructures (such as traditional dikes), which are enlarged and become the space for extra residential, recreational or retail activities.

2.3. Mapping

As presented in the previous points, the “active border” and the temporal component become essential aspects to achieve a resilient behaviour in urban waterfronts. These assumptions, however, pose serious issues within the design process. How is it possible to picture in one single, traditional frame all the variables affecting the urban waterfront environment as well as the huge uncertainty produced by climate change? How is it possible to design or even simply represent the temporality intrinsically embedded in the urban waterfront system without falling into the constriction of predetermined categories? How is it possible to “grasp” and translate into the design language the dynamicity of concepts such as transformability and adaptability that a resilient urban waterfront must embed? Mapping, and specifically “operative mapping” (Paez 2019), becomes the framework to answer these questions.

The notion of “map” and the related act of “mapping” have assumed different interpretations over time. Nevertheless, the main reasons behind the latter have rarely referred to just a neutral reproduction of reality, but they have been rather (consciously or unconsciously) connected to deeper aims, such as political aspirations, power creation or consolidation, social claims and recognition, or even cultural expressions. Especially from the second half of the past century, the operation of mapping started to move from a strongly descriptive and objective character (heritage of a long positivist tradition), to a more critical one (Harley & Paul 2001; Wood 2010) and, consequently, revealing soon its potentials also in fields different from traditional cartography. In particular, a strong relationship could be established between mapping and the design environment, where mapping is not a representation of the state of art *before* and *after* the deployment of a design act, but itself is intended as a design process (Corner, 1999). In these terms, in the context of this paper, three aspects of the “operative” character of mapping appear to be extremely resourceful:

1) *Mapping can become a mechanism for revealing and visualising hidden relations between the different components acting in urban waterfronts.* Unlike tracing products, which tend to reproduce a particular aspect of the reality and from a specific perspective, maps usually present several interpretation layers and, consequently, different interpretation “entryways”, which allow to establish connections among different agents of the same field or even different fields. In this way, mapping unfolds its inestimable potential of “uncovering realities previously unseen or unimagined, even across seemingly exhausted grounds” (Corner 1999, 213). In the context of the urban waterfront redevelopment, this potential of mapping plays a central role, since it represents the necessary operative framework that can help to bring together all the “hidden forces” influencing the development of waterfront areas, such as scientific and technical data (extreme weather and sea level rise predictions, flood risk areas, natural tidal fluctuations and water altimetry variation, ...), morphological characteristics (waterfront typology, geological conditions, bathymetry, ...), economic and social aspects (asset values and distribution, population growth and distribution, average income, ...), natural and cultural factors (traditional local activities, existing monumental artifacts, preserved natural ecosystems, ...) and urban features (urban fabric density and porosity, land use and urban development patterns, infrastructural systems, abandoned or poor quality areas, public spaces and green systems, ...) . Far from being just an analytical exercise, this moment already represents a first step of the design process, since it is exactly from a particular (subjective) combination and overlapping of certain indicators rather than others that possible design pathways unfold, leading to alternative and site-specific strategies of interventions able to explore spaces resilient against the unpredictability of climate change as well as to promote urban regeneration processes.

2) *Mapping is a tool for addressing dynamism and time.* The description of the previous key operative concepts has proved how the potential dynamism (both in its physical and temporal extensions) through which the urban waterfront system moves between the water and urban realms constitutes an essential requirement of a resilient behaviour. For this reason, it becomes fundamental to adopt tools that can visualize design possibilities rather than final statements, capturing the intrinsically changing nature of the waterfront system. From this perspective, mapping offers a possible answer to this necessity: despite the conventional two-dimensional and static format of the map, the already mentioned possibility to overlap different interpretation layers (describing, each of them, a particular feature or, in this case, “moment” of the system) in a single document enables the incorporation of wide variety of time-related information with great richness and precision as well as their understanding into a synthetic vision. In the context of urban waterfronts

redevelopment, this characteristic has a twofold implication: on the one hand, it allows to critically *understand* of the (physically and functionally) evolving character of a context (the urban waterfront) which is in constant flux and to question the traditional vision of a static territory; on the other hand, it enables to *design* transformation and adaptation to climate change events, becoming the instrument to conceive, represent and then consequently produce different states of the water-urban transition within the same design process.

3) *Mapping allows to manipulate and, ultimately, generate new realities.* A fundamental assumption of mapping, intended in its operative character, is to ultimately broaden our concept of reality and promote its transformation. Hence, rather than merely representative supports, maps can be interpreted as highly performative operations. Indeed, the potential of maps of creating links among different fields, besides the already mentioned capability to highlight the latent relational structures inside a system, can also turn the map itself into a working and experimentation space where to manipulate, distort or transpose reality according to the established design assumptions and, eventually, originate further unexpected connections. From this perspective, mapping becomes a tool to question conventional paradigms in favour of an active design exploration of different horizons, which, ultimately, has the potential to foster the sprout of new realities. In the context of urban waterfront, the extension of expression of “new realities” lies in the production of alternative realities that involve an innovative and more engaging interaction between water and urban settlements. Through the mapping platform, flood protection systems and urban and architectural structures can be combined in a potentially infinite sequence of explorative propositions, releasing the friction between the two fields but at the same time unfolding innovative scenarios and promoting the design creation.

An example of how mapping can be used in urban waterfronts to deal with both climate change consequences and urban planning aspirations can be found in the research *On the Water | Palisade Bay* (2007-2009). The two-year investigation, carried out by a multidisciplinary team led by the engineer Guy Nordenson and funded by the AIA’s 2007 Latrobe Prize, focuses on the redesign of the upper harbour of New York and New Jersey in response to the rise of sea levels and storm surges. The fundamental assumption of the research is to replace traditional “hard” engineering defence systems with “soft” strategies (such as wetlands and artificial islands), aiming at a more resilient relationship between land and water capable of becoming an enrichment for both people and natural habitats of the area. To achieve this purpose, mapping was assumed as both analytical and design instrument. Indeed, several indicators were identified in order to reveal information such as flood hazard characteristics (water depth, return periods, ...), elevation data (both above and under the water level), land cover (from “high intensity” development areas to more natural ones), buildings and infrastructures inventories (about building typologies and values, asset distribution, existing transportation pathways, primary facilities locations) and demographic data (population distribution, income, growth projections, ...); through the mapping act, these parameters were then combined to reveal how their interaction would affect the vulnerability of the research area to climate events in terms of inundation areas, direct and indirect economic impact and casualties. Furthermore, mapping played a fundamental role in the design development of the research proposal. The investigation of the historical profiles of the harbour, the current edge condition (paved, seawall, pier, building, revetment mud, natural, park, wetlands) and the predicted inundation areas (100 and 500-years floods) were combined in a series of maps (the “Edge Atlas”) which opened up the way for the definition of the site-specific strategies based on the idea of the waterfront as broad, porous, “fingered” resilient threshold between water, land and the city.

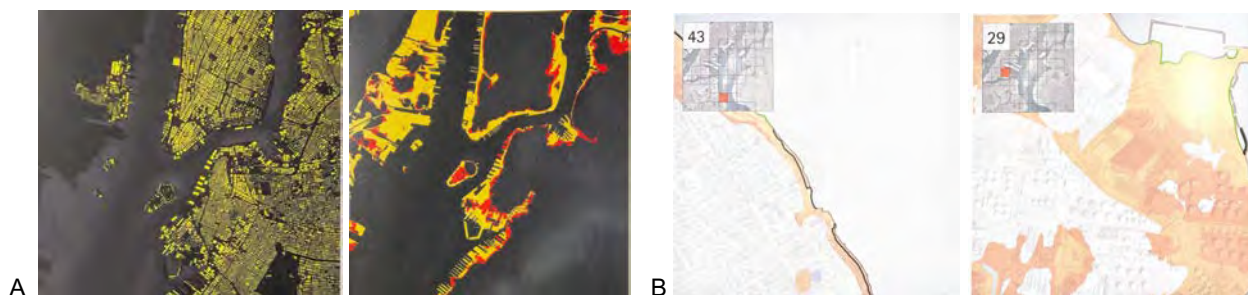

Figure 4: Mapping as an analytical tool (A) and a design tool (B) in the research *On the Water | Palisade Bay*. Source: Nordenson & al. 2010.

Another and maybe more extreme interpretation of mapping as an operative tool can be represented in the study the *Biesbosch Stad* presented by the landscape architect Michel Desvigne for the Architecture Biennale Rotterdam *The Flood* in 2005. The proposal tries to solve the challenge of reducing the flood exposure in the low-lying Dutch delta territory of the Biesbosch area, at the confluence of the Rhine and the Meuse rivers, by making room for water and, at the same time, creating scenarios for the massive construction of residential neighbourhoods (Tiberghien, Corner 2009). The solution to this apparently irreconcilable dichotomy is found exactly through the use of mapping as a design tool. This operation is seen as an opportunity to reveal time-based processes in the historical exploration of the existing landscape and, at the same time, to incorporate them as a main component of the design development. The map, indeed, is used not only to investigate the mechanisms which generated the current form of the polder landscape, but it becomes the operative field where to perform design actions to exasperate these processes, till the creation of an

almost paradoxically “inverted landscape”: at the moment the peat-rich area has gradually sunk due to the extensive drainage for agricultural activities perpetuated over the past decades, while the incompressible sandy riverbeds of the former streams (now dried out) have remained at the same level, creating a sort of pattern of “higher ridges” over the flat farmland; through his proposal, not only does Desvigne accept this phenomenon, but he exacerbates it, breaking the dikes to allow the water to flow unconstrained in case of flooding and, at the same time, rising the sandy beds and creating a safe space where to build on new dense neighbourhoods, circulation paths and parks.

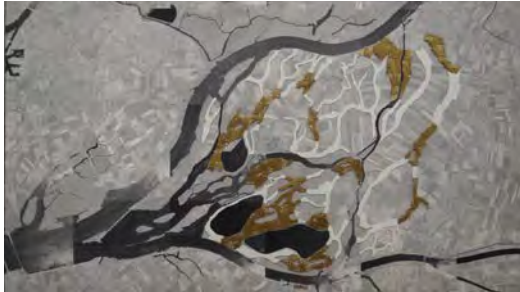

Figure 5: The *Biesbosch Stad* study. Source: Tiberghien & Corner, 2009.

CONCLUSION

As discussed at the beginning of this paper, the consequences of climate change will deeply affect the future developments of urban settlements and especially urban waterfronts, where the combination of this phenomenon with the recent socio-economic transformations has exacerbated the vulnerabilities of these areas, arising new challenges that traditional measures seem to be unable to effectively address. In particular, what seems to be missing in the development of urban waterfronts is a systemic approach which combines flood protection necessities with urban planning ambitions. As demonstrated in this paper, a possible starting point to solve this opposition is to reformulate the idea of urban “waterfront” through the concept of “resilience” and, in particular, to rethink the traditional relationship between built up and water, developing a design approach which involves water already in the early design stages as a main component of the space rather than background feature or a potential threat. However, rather than offering a *ready-to-use toolbox* of possible design solutions that might be used regardless of the peculiar characteristics of a particular context, this paper aimed at defining a *design methodology* for the development of urban waterfronts, conceived as a conceptual and operative ground to develop a systemic design paradigm capable of interpreting the specificities of different environments and then responding to future challenges according to these characteristics.

For this purpose, three operative key concepts were established, namely “*active border*”, *time component* and *mapping*. As demonstrated, these concepts are conceived as instruments to read an urban waterfront in its specific features, either existing or, as seen in some of the case studies, belonging to past development stages (*mapping*); to understand and reconceptualize it according to unconventional and innovative design perspectives which question the traditional temporal and physical design constraints (“*active border*”+ *temporal component*); and, finally, to select, combine or generate design actions that can actually shape the space and make it able to react in different ways according to the always changing external influences (“*active border*”+ *temporal component* + *mapping*). In other words, as highlighted by analysis of the selected case studies, through these operative key concepts it is possible to incorporate into the design that degree of adaptability and dynamicity that will make urban waterfront capable of withstanding the always higher unpredictability coming both from climate uncertainties and urban future development patterns and, at the same time, to be still deeply rooted in their peculiar context. Only in this way, the design process will be able to overpass the traditional dichotomy between safety necessities and urban ambitions and, at the same time, will not generate a general and abstract “urban quality”, but will effectively help to promote the enhancement of social, cultural and urban values peculiar of a specific context.

REFERENCES

- Aerts, J. and Botzen, W. 2011. *Climate adaptation and flood risk in coastal cities*. London: Earthscan.
- Bergdoll, B., & Museum of Modern Art (New York, N.Y.). 2011. *Rising currents: Projects for New York's waterfront*. New York: Museum of Modern Art.
- Boer F., Jorritsma J., van Peijpe D. 2010. *De Urbanisten and the Wondrous Water Square*. Rotterdam: NAI publishers.
- Bruttomesso, R. (2001). “Complexity on the urban waterfront”. In *Waterfronts in post industrial cities*, edited by R. Marshall, 39-49. London: Spon Press.
- Clément, G. 2004. *Manifesto del Terzo paesaggio*. Macerata: Quodlibet.
- Corner, J. 1999. “The Agency of Mapping: Speculation, Critique and Invention”. In *Mappings*, edited by D. Cosgrove, 213–252. London: Reaktion Books,
- Corner, J. 2006: “Terra fluxus”. In *The landscape reader*, edited by C. Waldheim, 21-33. New York: Princeton Architectural Press.

- da Cunha, D. 2019. *The invention of Rivers: Alexander's Eye and Ganga's Descent*. University of Pennsylvania Press.
- IPCC 2014. *Climate Change 2014: Synthesis Report. Contribution of Working Groups I, II and III to the Fifth Assessment Report of the Intergovernmental Panel on Climate Change* [Core Writing Team, R.K. Pachauri and L.A.
- Hallegatte, S., Green, C., Nicholls, R. et al. 2013. "Future flood losses in major coastal cities". *Nature Clim Change* 3.
- Hill, K. 2011. "Climate-Resilient Urban Waterfronts". In *Climate adaptation and flood risk in coastal cities*, edited by J. Aerts and W. Botzen, 123-143. London, UK: Earthscan.
- Holling, C. S. 1973. "Resilience and Stability of Ecological Systems", in *Annual Review of Ecology and Systematics* Vol.4 pp.1-23.
- Marshall, R. 2001. *Waterfronts in post industrial cities*. London: Spon Press.
- Mathur, A., and da Cunha, D. 2014. *Design in the terrain of water*, Print.
- Matos Silva, M. and Costa, J.P. 2017. "Flood adaptation measures applicable in the design of urban public spaces: Proposal for a conceptual framework". *Water*, 9, 243.
- Nazif S., Mohammadpour Khoie M.M., and Eslamian S. 2021. "Urban Disaster Management and Resilience". In *Handbook of Disaster Risk Reduction for Resilience*, edited by Eslamian S., Eslamian F. Springer, Cham.
- Neumann B., Vafeidis A.T., Zimmermann J., and Nicholls R.J. 2015. "Future Coastal Population Growth and Exposure to Sea-Level Rise and Coastal Flooding - A Global Assessment". *PLoS ONE* 10(3): e0118571.
- Nicholls, R. and Cazenave, A. 2010. "Sea-Level Rise and Its Impact on Coastal Zones". *Science* (New York). 328.
- Nordenson, G., Seavitt, C., Yarinsky, A., Veit, R., The Museum of Modern Art, & Exhibition Rising Currents: Projects for New York's Waterfront. 2010. *On the water: Palisade Bay*.
- Paez, R. 2019. *Operative Mapping: Maps as Design Tools*. Barcelona: Actar Publishers, Elisava.
- Sennet, R. (2006). "The Open City". In *Urban Age. Towards an Urban Edge*. Available at: <https://urbanage.lsecities.net/essays/the-open-city> (accessed October 2021).
- Shannon, K., and Smets, M. 2016. *The landscape of contemporary infrastructure*. Rotterdam: Nai Publisher.
- Tiberghien, G. A., Corner, J. 2009. *Michel Desvigne - Intermediate Nature*. Birkhäuser: Basel.
- UNISDR 2015. *Sendai framework for disaster risk reduction 2015 to 2030*. <https://www.undrr.org/publication/sendai-framework-disaster-risk-reduction-2015-2030>, (accessed August 15, 2021).
- Wood, Denis, John Fels, and John Krygier. 2010. *Rethinking the power of maps*. New York: Guilford Press.

Understanding Efficient Mitigation Strategies for Los Angeles' Heat Islands Using OLS Regression Analysis

Olivia V. Lewis¹, Pablo LaRoche¹, Joey-Michelle Hutchison¹, Arianne Ponce¹

¹CallisonRTKL, Los Angeles, CA

ABSTRACT: As architects design the cities of the future, the climatological impact of the built environment must be considered. Previous research has shown that the Urban Heat Island (UHI) effect is exacerbated by the presence of impervious surfaces and mitigated by cooling features such as urban forestry, water features, and vegetation (Ruiz-Aviles, 2020), (Hoffman, 2020). Through the analysis of satellite imagery of Los Angeles County, this study expands the scope of UHI research by creating regression models to explain the relative impact of multiple variables on land surface temperature. These variables include impervious surface, water, forestry, vegetation, and surface reflectance among others in Part I. Preliminary results indicate that increasing the density of impervious surface development is associated with higher temperatures while the presence of vegetation, tree canopy, and water reduces temperature significantly. In Part II, the researchers calculate the economic cost of poor UHI mitigation by estimating the cost of mechanical cooling to achieve occupant comfort. The purpose of this estimation is to quantify the financial benefit associated with implementing naturally cooling designs in new and existing buildings. Part II also includes suggestions for design strategies intended to optimize heat mitigation based on our findings.

KEYWORDS: regression analysis, Urban Heat Islands, land surface temperature, cooling design, cost analysis

INTRODUCTION

Continued expansion and development of urban spaces is inevitable with a growing global population. Research also shows that the intensity, duration, and frequency of heat waves in Los Angeles are increasing as the effects of global climate change continue (Perkins-Kirkpatrick, 2020). Taking these two unavoidable truths into consideration, architects have a responsibility to design their projects with a substantial focus on limiting the Urban Heat Island (UHI) effect around their designs. The UHI effect describes the phenomenon of urban areas having significantly higher temperatures than surrounding rural areas. This is caused by a variety of factors including a lack of vegetation and shade from tree canopy, incidence of impervious surfaces such as asphalt and concrete that increase surface and ambient temperature, and many others (Abbas, 2017). Extreme heat can have devastating effects on many facets of life, from increases in heat related deaths to wildfires to overwhelming power grid demand (Burillo, 2019) (Bartos, 2014). Extreme heat is uncomfortable for Los Angeles residents and disproportionately impacts lower income communities (Bartos, 2014). If architects are able to effectively design buildings to control the surrounding and internal temperature, the results of this study demonstrate that this could have a legitimate impact on mitigating the UHI effect. The heat map used to build the regression models and inform the conclusions of this project is shown in Figure 1. The entire study area was subsequently partitioned into smaller sample areas which are also shown in Figure 1. The high desert area of Los Angeles County was not sampled because the area is not as densely developed as the central, southern, and western parts of the county and therefore is not as strong of a candidate for urban infrastructure intervention to mitigate heat.

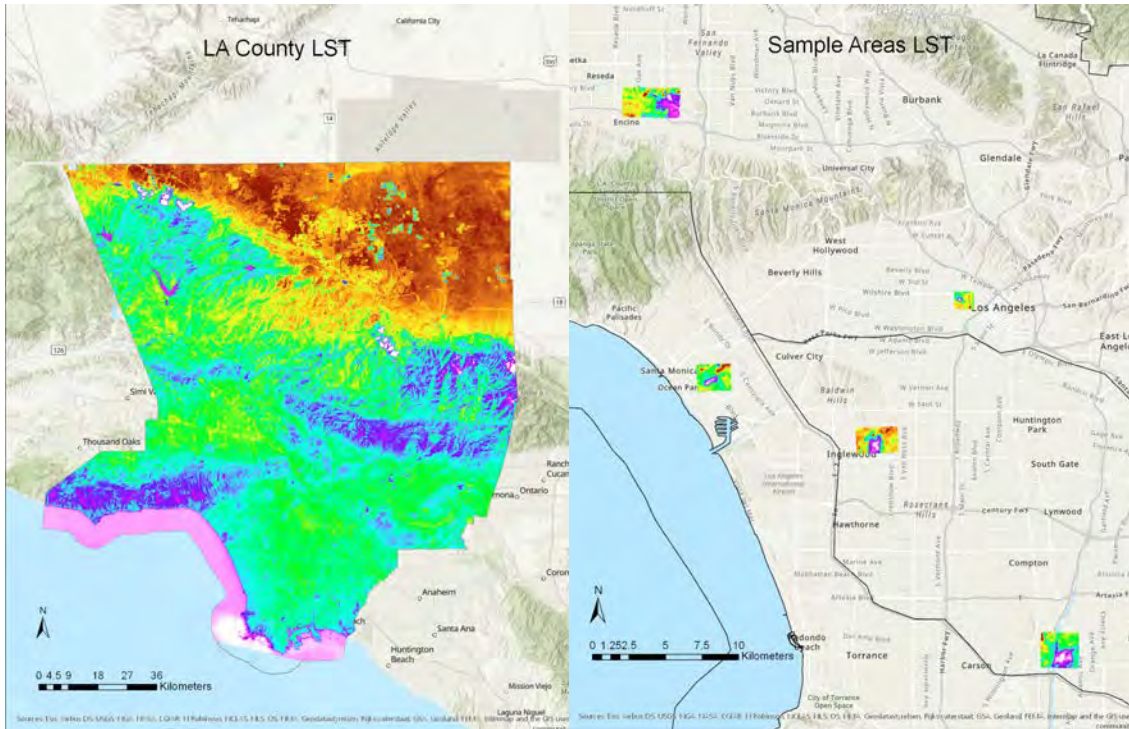

Figure 1: Land surface heat map of the entire study area from which the samples are drawn and used to create representative regression models (L). Heat maps of the sampled areas, also showing Climate Zone boundaries (R).

1.0 LITERATURE REVIEW AND DATA PREVIEW

1.1 Existing Research

The goal of this study is to assess the Urban Heat Island effect through a multidisciplinary approach providing specific recommendations at the urban and architectural scale. Most of the existing literature looks at a single factor influencing the distribution of land surface temperature. Many studies specifically examine the relationship between historical divestment in low-income, minority communities and higher temperatures (Hoffman, 2020). In “The Effects of Historical Housing Policies on Resident Exposure to Intra-Urban Heat: A Study of 108 U.S. Urban Areas”, the authors show that historically redlined neighborhoods are more likely to experience hotter temperatures due to a lack of green spaces and mature tree canopy to provide shade (Hoffman, 2020). However, green space and tree canopy are not the only factors involved in cooling an area. As seen in “Mitigation of Urban Heat Island Effects through ‘Green Infrastructure’: Integrated Design of Constructed Wetlands and Neighborhood Development”, constructed wetlands and water features in traditionally dry climates that do not naturally support forestry can also lead to a cooling effect and reduction of urban heat islands (Ruiz-Aviles, 2020). Multiple other studies such as “Low carbon districts: Mitigating the urban heat island with green roof infrastructure” support the hypothesis that adding green infrastructure or green space to existing urban areas can mitigate the urban heat island effect (Lehmann, 2014). There is an established, statistically significant relationship between increased Normalized Difference Vegetation Index (NDVI) caused by live vegetation and lower summer surface temperatures (Kaufmann, 2003). The authors of “Low carbon districts” specifically state that although green roofs are a potential solution to the urban heat island effect due to their established temperature controlling properties, they do not always contribute to native biodiversity (Lehmann, 2014). This issue is addressed by this study’s unique micro-sampling approach to determine the specific needs of various climates within Los Angeles. Notably lacking from the existing lexicon of research on this topic is a methodology that seeks to understand the combined effect of these known warming and cooling factors. As a result, studies without a diverse set of variables can contribute to a biased result. Omitted variable bias leads to either over or understating the impact of a variable of interest on the dependent variable (Omitted Variable Bias: Wald Test, 2021). This study also seeks to account for the many climates included within Los Angeles County, which differs from the methodologies of existing, similar studies that tend to assess an entire city through an internally comparative lens.

1.2. Data

Existing scientific literature informs this study’s choices of explanatory variables, as well as the data sources used. Based on a thorough literature review process, the researchers decided to include land cover type, infrared reflectance, near infrared reflectance, short wave infrared reflectance, and distance to roads as explanatory criteria for the dependent variable land surface temperature. The three reflectance types reflect the albedo effect and account for the

presence of vegetation, which can be left out of the land cover type dataset due to the nature of the source. To calculate Land Surface Temperature and Reflectance, the researchers used Landsat8 imagery sourced from the United States Geological Survey (USGS). Landsat8 images were only considered if they included cloud cover of less than 10% and if they were recorded during the daylight hours of the summer months. Using a 10% threshold for cloud cover is consistent with the study design in existing literature (Dialesandro, 2021), (Hoffman, 2020). The presence of clouds has a cooling effect on temperature during the day, and a warming effect at night which can result in inaccurate land surface temperature calculations as well as a complete inability to calculate the land surface temperature or surface reflectance for areas that are obscured partially or completely (Jeppesen, 2019). Vegetation has a cooling effect on summer temperatures and a warming effect on winter temperatures (Bumseok, 2018). This study focuses on determining the most efficient heat mitigation strategies, so it makes sense to assess only summer months. The extreme temperatures associated with the summer months provide more relevant information with regards to the economic cost of extreme heat events when mitigation tactics are not employed. Land cover type data was sourced from the National Land Cover Database, while data showing all roads was sourced from Los Angeles' geodatabase portal LA Geohub. Climate Zone and LA County boundaries were also sourced from LA Geohub. The data used to calculate the economic cost of running low efficiency air conditioning units is based on the methodology in "Efficiency, economics, and the urban heat island" (Miner, 2017). This study quantified the costs of running low efficiency window AC units for Phoenix, AZ as well as other cities with a documented heat island effect. The authors used cooling degree days as estimated by the online tool Bizee Degree Days (Miner, 2017). Since the target estimation is similar, the methodology of this paper closely followed that of "Efficiency, economics, and the urban heat island". Estimations for the daily cost of running these low efficiency air conditioners as well as the proportion of households using window units instead of central air conditioning, which is more cost effective, comes from the Residential Energy Consumption Survey completed by the U.S. Energy Information Administration (RECS, 2015). Results are illustrative of potential impact and could be larger or smaller depending on the difference between estimated number and type of air conditioning units and actual numbers.

2.0 METHODS AND RESULTS

2.1. Methods

This study was completed in two parts, each with a distinct workflow and methodology. Part I was completed using ArcGIS Pro and R statistical software. Figure 2 shows the methodology workflow of Part I which begins with loading all the relevant data sets into ArcGIS Pro using a 30x30m pixel size. The study uses the Projected Coordinate System NAD 1983 UTM Zone 11N. California is designated into 16 Climate Zones, each representing a different microclimate. LA County includes five of these climate zones, and this study samples the three prominent ones. Climate Zone 6 includes the milder coastal region, while Zones 8 and 9 include warmer inland areas. These sample areas were chosen where the researchers observed a diverse selection of roads, urban infrastructure, and vegetation. Small-scale samples allow the regression to be performed at the pixel level (30x30m). Samples were only considered if the observed elevation is roughly homogenous, as large changes in elevation over a short physical distance can impact surface reflectance. Equations (1)-(7) specify the functions used to calculate Land Surface Temperature (LST) and surface reflectance. Top of Atmosphere spectral reflectance (L) is found using equation (1).

$$(1) L = M_L * Q_{cal} + A_L$$

Where M_L is the band specific multiplicative rescaling factor as written in the metadata documentation, Q_{cal} is the Thermal Band (Band 10), and A_L is the Band specific additive rescaling factor as written in the metadata. The results from this calculation are then used to calculate the Brightness Temperature adjusted from Kelvin to Celsius. This is found with equation (2).

$$(2) BT = (K_2 / (\ln (K_1 / L) + 1)) - 273.15$$

Where K_1 and K_2 are both band specific thermal conversion constants stated in the metadata, and L is the TOA Spectral Reflectance previously calculated. Then, we calculated the Normalized Difference Vegetation Index (NDVI) using Band 4 (Infrared) and Band 5 (Near Infrared) in equation (3).

$$(3) NDVI = (Band\ 5 - Band\ 4) / (Band\ 5 + Band\ 4)$$

The NDVI is closely related to the Percent Vegetation (P_v), which we calculate using equation (4).

$$(4) P_v = [(NDVI - NDVI_{min}) / (NDVI_{max} - NDVI_{min})]^2$$

P_v is used to calculate emissivity (ϵ), which is the final step needed before calculating LST. ϵ is found using equation (5).

$$(5) \epsilon = 0.004 * P_v + 0.986$$

The value of 0.986 is a correction value for the equation. Finally, LST is calculated using equation (6).

$$(6) LST = (BT / (1 + (0.00115 * BT / 1.4388) * \ln(\epsilon)))$$

To calculate Infrared Reflectance, Near Infrared Reflectance, and Short-Wave Infrared Reflectance, this study uses the same Landsat8 imagery using the Infrared, Near Infrared, and Multispectral bands and equation (7).

$$(7) [(DN * 0.00002) - 0.1] / \cos(S_z)$$

Where DN indicates the band specific digital number, 0.00002 is the band specific multiplicative reflectance rescaling factor, -0.1 is the band specific additive reflectance rescaling factor, and S_z is the solar zenith angle as written in the metadata.

To prepare the raster data for regression, the land cover type codes from the NLCD were converted into indicator variables. The base case indicator variable is impervious surface with an impervious surface/vegetation split of less than 20% impervious surface, greater than or equal to 80% vegetation or undeveloped open space. The models were estimated using Ordinary Least Squares regression and then select variables were standardized using a standardized beta coefficient for interpretation. Table 3 shows the standardized beta coefficients for the surface reflectance explanatory variables within each sample.

Table 1: Description of the explanatory variables used in the regression models

Variable	Description	Example	Source
Land Cover Type Indicators (specified below)	For each land cover type present in the sample area, the land cover indicators take on a value of either 0 or 1 if the 30x30m unit of analysis is classified as the respective land cover type	Water, Herbaceous Wetland, Shrub/Scrubs, Mixed Forest, Impervious Surface	National Land Cover Database (NLCD)
Near Infrared Reflectance (NR)	Near Infrared Reflectance is a measure of surface reflectance and increases with the presence of vegetation.	Golf courses, urban forestry, parks, living roofs, tree lined streets, landscaped medians, living walls	Landsat8 imagery
Shortwave Infrared Reflectance (SR)	Shortwave Infrared Reflectance is a measure of surface reflectance that is commonly used to assess mineral content, as well as soil moisture.	Minerals in rocks or other reflective surfaces	Landsat8 imagery
Infrared Reflectance (RR)	Infrared Reflectance is a measure of surface reflectance and increases with the presence of impervious surface and other man-made materials	Asphalt, cement, metal, large buildings	Landsat8 imagery
Distance to Nearest Road (D)	The Euclidean distance in meters from the nearest road to a 30x30m unit of analysis		Los Angeles County Geohub Database

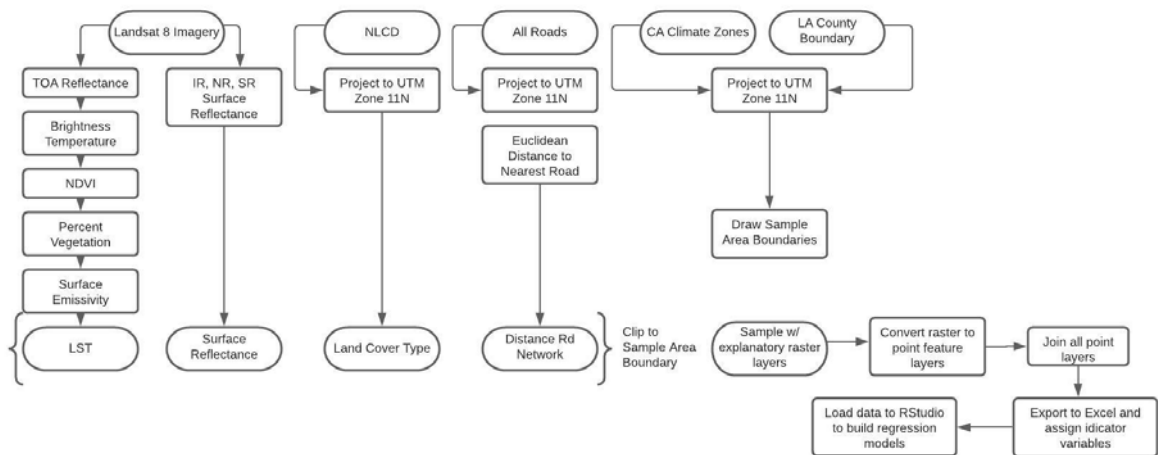

Figure 2: Part I Workflow Diagram showing the logical progression of determining the relative effect of existing elements on Land Surface Temperature.

In Part II, the workflow diagram specifies a simple arithmetic approach to estimate the costs of running low-efficiency air conditioners annually in the three climate zones of Los Angeles that were incorporated in the regression. This was the focus of the cost analysis because reducing the incidence of these low efficiency AC units is a feasible goal that would require investment in small scale design choices like living roofs to passively cool a residential or commercial space through indirect and direct impacts. To estimate the cost of this usage, the researchers calculated the number of households within each climate zone that are currently using window AC units using demographic data from the U.S. Census, Climate Zone boundaries, and AC data from the 2015 Residential Energy Consumption Survey (Residential Energy Consumption Survey, 2015). Figure 3 shows the workflow for Part II.

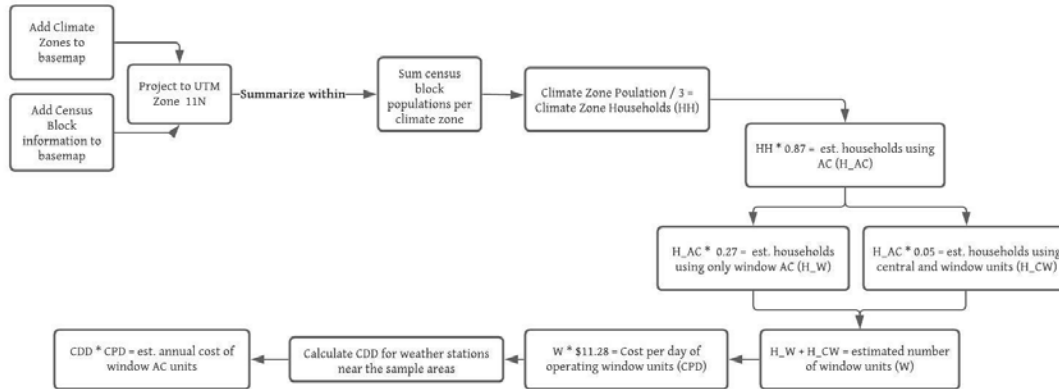

Figure 3: Workflow diagram for Part II methodology: Approximate the cost of AC usage for each Climate Zone to estimate consumer savings potential with widespread implementation of living roofs.

2.2. Results

In ArcGIS, the raster layers representing each of the explanatory variables clearly indicate patterns in LST. Figure 4 shows the explanatory layers juxtaposed next to LST for the San Fernando Valley (SFV) sample as an example of the ArcGIS results seen in all five samples. Assessing the heat map image relative to the explanatory factors in the following layers, there is a clear halo effect of cooling surrounding particularly effective features such as the golf course, lake, and naturally banked LA river. The relatively cool spots generated by the cooling features extends beyond their physical boundaries, resulting in a cooler land surface temperature for the immediately surrounding area regardless of the factors present there. This observation indicates that the benefits of designing living infrastructure extend beyond the physical extent of the design itself and can be strategically placed to optimize the general cooling impact. The opposite effect is true for warming features such as dense impervious surface development as seen following the 101-freeway running from the top to the middle right side of the sample and within the residential neighborhood without significant green space in the bottom left corner of the sample.

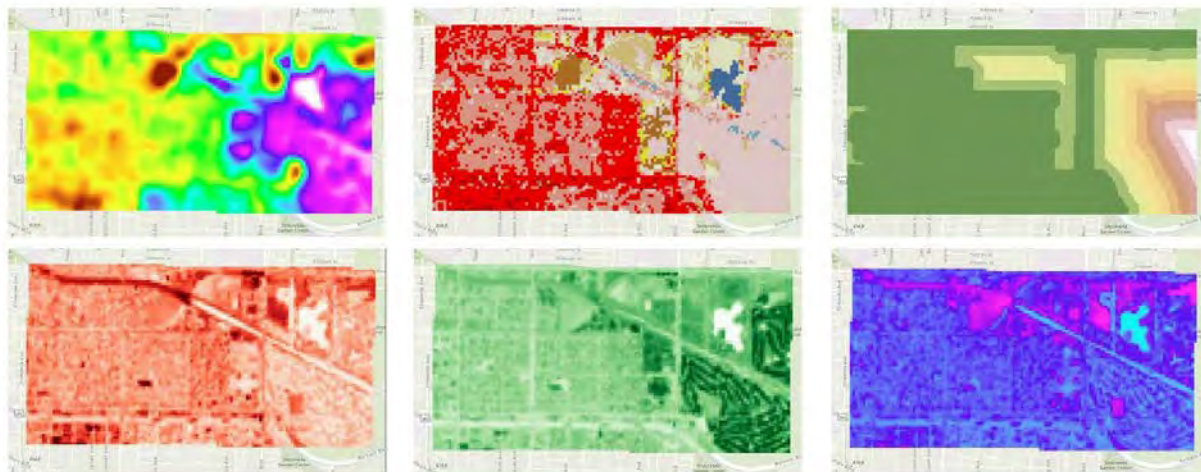

Figure 4: ArcGIS raster layers example clockwise from left: Land Surface Temperature; Land Cover Type; Distance to Nearest Road; Shortwave Infrared Reflectance; Near Infrared Reflectance; Infrared Reflectance

For each of the five samples, the resulting regression model quantifies the relationship between the existing urban design elements and land surface temperature as it varies across the surface area of each sample. Since there are both continuous and binary explanatory variables included the model, the models are interpreted first using the traditional coefficient estimates and then they are standardized to interpret the continuous variables specifically. Table 2 describes the samples for which there are two regression models.

Table 2: Sample Areas, their abbreviation, and Climate Zone represented

Sample Name	Abbreviation	Climate Zone
Santa Monica	SM	6
North Long Beach	NLB	8
Inglewood	ING	8
Downtown LA	DTLA	9
San Fernando Valley	SFV	9

The regression models are shown in equations (8) through (12):

$$(8) T_{SM} = 31.49 + .008D + 5.895RR - 10.667NR + 8.978SR + 0.91IS_{50} + 1.129IS_{80} + 1.519IS_{100} + 1.462S + 0.241P + \epsilon$$

$$(9) T_{NLB} = 32.297 - 0.006D + 8.274RR - 10.606NR + 6.617SR + 0.347IS_{50} + 1.448IS_{80} + 2.327IS_{100} - 0.455S + 1.638P + 0.8H - 2.534E - 0.143W + \epsilon$$

$$(10) T_{ING} = 33.283 + 0.005D + 10.075RR - 12.830NR + 3.734SR + 0.848IS_{50} + 1.44IS_{100} + 1.479IS_{81} + 0.947S + 0.876P + 0.571H + \epsilon$$

$$(11) T_{DTLA} = 33.102 + 0.002D + 4.846RR - 8.746NR + 6.801SR + 1.712IS_{50} + 2.341IS_{80} + 2.613IS_{100} - 3.288W + \epsilon$$

$$(12) T_{SFV} = 34.065 - 0.003D + 4.955RR - 9.304NR + 14.099SR + 0.822IS_{50} + 0.995IS_{80} + 1.531IS_{100} + 0.526S - 0.437P + 0.387H - 3.113W - 0.571HW + \epsilon$$

Where:

T_{xxx} = Sample Land Surface Temperature

D = Euclidean Distance to nearest road

RR = Infrared Reflectance

NR = Near Infrared Reflectance

SW = Shortwave Infrared Reflectance

IS_x = Impervious Surface / Vegetation mix \leq x%

S = Shrub / Scrub Land Cover

P = Pasture Land Cover

H = Herbaceous Land Cover

E = Evergreen Forest Land Cover

W = Open Water Land Cover

HW = Herbaceous Wetland Land Cover

These regression models fit the data well, with adjusted R-squared values ranging from 0.500 to 0.778. In the case of the San Fernando Valley sample (Figure 4), increasing the mix of impervious surface and open space to be between 21 and 50% (IS_{50}) is associated with an increase of 0.822 degrees Celsius on average compared to areas with less than 20% impervious surface. Further increasing the percent of impervious surface within the 30x30m area to between 51 and 80% (IS_{80}) is associated with an increase of 0.995 degrees Celsius on average compared to again to the omitted indicator case. Areas with between 81 and 100% impervious surface are associated with an average increase of 1.531 degrees Celsius as compared to the base case indicator. This pattern is consistent throughout the other sample areas as well. The average temperature increases relative to the base case as the amount of impervious surface increases. This consistency across the samples is what indicates that the percent area covered by impervious surfaces is a critical variable to consider when planning and designing new urban infrastructure. The base case indicator allows for some necessary development while prioritizing the open space, vegetation component.

Table 3: Standardized Beta Coefficients of the models

Sample	RR	NR	SW
SM	0.1521	-0.4668	0.1903
NLB	0.2267	-0.3874	0.1523
ING	0.2032	-0.4684	0.0805
SFV	0.0781	-0.3451	0.2944
DTLA	0.1219	-0.2702	0.1481

The standardized Beta coefficients not only simplify the interpretation process, but also indicate the relative impact of each of the explanatory variables on land surface temperature as compared to each other. A variable with a larger standardized beta coefficient in absolute value has a larger impact on LST than other variables. Consistently, Near Infrared Reflectance has a cooling effect on temperature as seen in Table 4. Increasing the Near Infrared Reflectance of a 30x30 meter by one standard deviation decreases land surface temperature by 0.4668 standard deviations in Santa Monica, 0.3874 standard deviations in North Long Beach, 0.4684 standard deviations in Inglewood, 0.3451 degrees in the San Fernando Valley, and 0.2702 standard deviations in Downtown LA on average. Increasing Near Infrared Reflectance by one standard deviation also has a relatively stronger impact on land surface temperature than Infrared Reflectance or Shortwave Infrared Reflectance also as noted in Table 4. Infrared Reflectance is associated with larger amounts impervious surfaces and other man-made development while Near Infrared Reflectance is increased by adding vegetation to the area.

Both the traditional linear model and the standardized beta coefficients show a few variables with consistent impact on land surface temperature across the samples and regardless of the surrounding environment. These are referred to in this study as strong indicators of heating and cooling effects and are summarized in Table 4. Negative values indicate features with a cooling impact on LST, while positive values indicate a feature with warming properties. Therefore, more negative values are preferable, while positive values should be reduced by employing heat conscious design strategies.

Table 4: Strong indicators of cooling or warming. Variables marked with * are standardized beta coefficients.

Variable	SM	NLB	ING	SFV	DTLA
RR*	0.1521	0.2267	0.2032	0.0781	0.1219
NR*	-0.4668	-0.3874	-0.4684	-0.3451	-0.2702
SW*	0.1903	0.1523	0.0805	0.2944	0.1481
IS ₅₀	0.91	0.347	0.848	0.822	1.712
IS ₈₀	1.129	1.448	1.44	0.995	2.341
IS ₁₀₀	1.519	2.327	1.479	1.531	2.613
W	--	-0.143	--	-3.113	-3.288

Strong indicators of LST include Infrared, Near Infrared, and Shortwave Infrared Reflectance, all three designations of impervious surfaces, and water. According to the coefficient value for water shown in Equation 9 as well as in Table 4, areas in that sample (NLB) were only 0.143 degrees cooler on average than the base case. This is in stark contrast to the impact of water in the San Fernando Valley sample, where areas of water were on average 3.113 degrees cooler than the base case indicator. Similarly, in the Downtown LA sample, areas of water were on average 3.288 degrees cooler than the base case. The discrepancy between the cooling effect of water in North Long Beach and the other samples points out the importance of surrounding development in creating effective temperature control. In North Long Beach, the banks of the LA River are replaced by a cement canal. The surface reflectance and heat generated by this high concentration of impervious surface counteracts the cooling effect of water in the area. This indicates that simply developing water features without a commitment to also restoring natural herbaceous wetland, wetland, or other vegetation is an inefficient cooling strategy. Water is much more effective at cooling the local area when paired with natural elements such as herbaceous wetland natural banking.

The estimated cost of the air conditioning usage reflects consumer spending on climate control. The lowest customer expenditure is in the coastal climate zone (Zone 6), while the two inland zones have higher estimated levels of spending. AC usage also impacts public spending as power grid demand increases on days of extreme heat if buildings are not designed in a way to effectively control the climate without the use of air conditioning. Empirically proven, quantitative data with a direct link to potential cost savings has the potential to be very convincing in the planning stages of a project. Increasing the specific cooling features in an area by designing living roofs, walls, and naturally banked water features is linked to cooler temperatures, which reduce the number of cooling degree days where AC units must be used.

3.0 CONCLUSION

Based on these results, the most efficient cooling design strategies in all LA Climate Zones are those that increase Near Infrared Reflectance through vegetation. In special cases, water features can also be a major cooling factor. This can be incorporated into building designs by adding a living roof, living wall, or other urban forestry such as courtyards and tree lined streets and walkways. Unlike vegetation, which has a universally efficient cooling impact, the cooling efficiency of water is conditional upon the surrounding infrastructure. In less densely populated regions of LA County, focusing on restoration efforts of wetland areas will increase existing water features' cooling impact, and will also increase the amount of Near Infrared Reflectance by introducing vegetation. Wetland rehabilitation and designs that seek to preserve native wetland or coastal vegetation should be of particular focus in Climate Zone 6, which benefits from a less dense urban sprawl and is directly adjacent to the Pacific Ocean. For all climate zones, the preferred cooling

roofs has been done. His designs focus on the direct cooling impact of a green roof with respect to thermal comfort and a reduced need for air conditioning (LaRoche, Yeom, 2019). The results of this study show that green roofs also have an indirect cooling impact by increasing the amount of Near Infrared Reflectance and therefore providing an efficient means of general temperature control to the area. When the use of impervious surfaces is necessary, designs should prioritize at least a less than 50% split between impervious surface and open space (ideally filled with native species of vegetation). Designs that keep the impervious surface/ open space split less than 20% are ideal when possible. This can be achieved through the integration of vegetation into the architecture of the building. Again, this is best achieved using biodiverse living roofs, especially in areas that are already developed (La Roche, Yeom, 2019).

The results of this study demonstrate that increasing vegetation in an area has a relatively stronger impact on land surface temperature than increasing impervious surfaces. This is a positive indicator in the pursuit of true mitigation of the urban heat island effect. With a universal commitment to incorporating living designs into the architecture of new and existing buildings, efficient urban cooling is possible at a micro and macro level.

REFERENCES

- Bartos, Matthew and Mikhail V. Chester. 2014. "Assessing Future Extreme Heat Events at Intra-urban Scales: A Comparative Study of Phoenix and Los Angeles."
- Bumseok Chun, Guldmann, Jean-Michel. 2018. "Impact of greening on the urban heat island: Seasonal variations and mitigation strategies" *Computers, Environment and Urban Systems* 71: 165-176. <https://doi.org/10.1016/j.compenvurbysys.2018.05.006>
- Burillo, Daniel, Mikhail V. Chester, Stephanie Pincetl, and Eric Fournier. 2019. "Electricity infrastructure vulnerabilities due to long-term growth and extreme heat from climate change in Los Angeles County" *Energy Policy* 128: 943-953. <https://doi.org/10.1016/j.enpol.2018.12.053>
- Dialesandro, J., Brazil, N., Wheeler, S., and Abunnasr, Y. 2021. "Dimensions of Thermal Inequity: Neighborhood Social Demographics and Urban Heat in the Southwestern U.S." *International journal of environmental research and public health* 18 no. 3: 941. <https://doi.org/10.3390/ijerph18030941>
- Hoffman, Jeremy S., Vivek Shandas, and Nicholas Pendleton. 2020. "The Effects of Historical Housing Policies on Resident Exposure to Intra-Urban Heat: A Study of 108 US Urban Areas" *Climate* 8, no. 1: 12. <https://doi.org/10.3390/cli8010012>
- Jeppesen, Jacob Høxbroe, Rune Hylsberg Jacobsen, Fadil Inceoglu, and Thomas Skjødeberg Toftegaard. 2019. "A cloud detection algorithm for satellite imagery based on deep learning" *Remote Sensing of Environment* 229: 247-259. <https://doi.org/10.1016/j.rse.2019.03.039>
- Kaufmann, R. K., Zhou, L., Myneni, R. B., Tucker, C. J., Slayback, D., Shabanov, N. V., and Pinzon, J. 2003. "The effect of vegetation on surface temperature: A statistical analysis of NDVI and climate data" *Geophysical Research Letters* 30, no. 2147: 22. doi:10.1029/2003GL018251
- La Roche, Pablo, Dongwoo Jason Yeom, and Arianne Ponce. 2020 "Passive Cooling with a Hybrid Green Roof for Extreme Climates" *Buildings & Energy* 224: 1-12. <https://doi.org/10.1016/j.enbuild.2020.110243>
- Lehmann, Steffen. 2014. "Low Carbon Districts: Mitigating the Urban Heat Island with Green Roof Infrastructure" *City, Culture, and Society* 5, no. 1: 1-8. <https://doi.org/10.1016/j.ccs.2014.02.002>
- Miner, Mark J., Robert A. Taylor, Cassandra Jones, and Patrick E. Phelan. 2017. "Efficiency, Economics, and the Urban Heat Island" *Environment & Urbanization* 29 no. 1: 183-194. doi:10.1177/0956247816655676
- Mohajerani, Abbas, Jason Bakaric, and Tristan Jeffrey-Bailey. 2017. "The urban heat island effect, its causes, and mitigation, with reference to the thermal properties of asphalt concrete" *Journal of Environmental Management* 197: 522-538. <https://doi.org/10.1016/j.jenvman.2017.03.095>
- "Omitted Variable Bias: Wald Test," Data Science Concepts, September 29, 2021, [Omitted Variable Bias: Wald Test – Data Science Concepts](https://www.data-science-connections.com/omitted-variable-bias-wald-test/).
- Perkins-Kirkpatrick, S.E., S.C. Lewis. 2020. "Increasing trends in regional heatwaves" *Nature Communications* 11, no. 3357. <https://doi.org/10.1038/s41467-020-16970->
- "Residential Energy Consumption Survey," U.S. Energy Information Administration, 2015, [Residential Energy Consumption Survey \(RECS\) - Data - U.S. Energy Information Administration \(EIA\)](https://www.eia.gov/energyconsumption/)
- Ruiz-Aviles, Victor, Anthony Brazel, Jonathan M. Davis, and David Pijawka. 2020. "Mitigation of Urban Heat Island Effects through "Green Infrastructure": Integrated Design of Constructed Wetlands and Neighborhood Development" *Urban Science* 4, no. 4: 78. <https://doi.org/10.3390/urbansci4040078>

Evaluating the Circadian-Effectiveness of Light through Personal Light Exposure Measurement: An Initial Test Using a Low-Cost and Wearable Spectrometer in Home-Office

Armin Amirazar¹, Mona Azarbayjani¹, Maziyar Molavi²

¹University of North Carolina at Charlotte, Charlotte, NC

²Raja University, Qazvin, IRAN

ABSTRACT: Lack of affordable and reliable wearable spectrometers to record the characteristics of light exposure as a stimulus that affects the human circadian system is evident. This study aimed to measure and evaluate the circadian effectiveness of personal lighting conditions of two office workers using a low-cost and wearable spectrometer. We continuously measured personal lighting conditions of two office workers over the course of eight days. They also were asked to self-report their daily schedules and locations during the measurements. Comparison between two office workers across the study period revealed significant benefits of utilizing dynamic electric lighting in combination with daylight regarding circadian-effective light level that they were exposed to. However, outcomes were dependent on inter-individual differences such as different wake/sleep patterns, and workspace characteristics such as distance to window. The present study is the first to employ a low-cost and wearable spectrometer that allows to measure light source's SPDs in real-time and store personal light exposure data on Firebase cloud database using wireless communication. The spectrometer prototype developed in this study has potential to be integrated into an IoT-based smart lighting system for continuous monitoring of personal lighting conditions.

KEYWORDS: Circadian-effectiveness of light; Non-visual effects of light; Circadian Stimulus; Low-cost spectrometer; Personal lighting condition

INTRODUCTION

Natural light is an important element of building design that influences human health, comfort, performance, and well-being. Natural light provides a combination of the right types of light with the right spectral content at the right times. Humans' daily rhythms in behavior and physiology such as wake/sleep patterns have evolved under natural light-dark cycles over millions of years. However, the invention of electric lighting has dramatically changed human home, social and work environments by shifting the light exposure pattern from natural light to electric light over the past decades. Currently, in the US, exposure to natural light is significantly reduced as people spend more than 87% of their working hours indoors in comparison to the 1800s where they spent about 90% of their time working outside (Klepeis et al. 2001). Despite the advantages of this invention for humankind, lack of natural light exposure during the day and increased exposure to electric light during the night is associated with psychological, physical, and mental health issues that can disrupt circadian rhythms and sleep. Circadian rhythm is a natural process that regulates sleep-wake cycle by synchronizing the internal clock to roughly a 24-hours diurnal cycle in an outdoor environment. Disruption of circadian rhythm may result in mood disorders, displacement of wake/sleep cycle, melatonin suppression, and phase-shifting of the circadian system. Ocular light exposure provides measurable benefits for both visual and non-visual systems. Even though we interact with our environment through a visual system, the discovery of the third class of photoreceptor within the eye (Berson, Dunn, and Takao 2002), named Intrinsically Photoreceptive Retinal Ganglion Cells (ipRGCs), placed increased attention on unseen effects of light that influence our mood, alertness, emotion, health and sense of well-being. Deviation from regular light-dark exposure patterns negatively affects sleep (M. G. Figueiro and Rea 2010), mood (M. G. Figueiro et al. 2017), performance (Mallis and DeRoshia 2005), and is associated with a range of health issues such as seasonal affective disorder (Thorne et al. 2009), and even cancer (Cordina-Duverger et al. 2018). Nowadays, as we spend a large proportion of our time in the built environment, we are exposed to less light during daytime hours and more light during nighttime hours than what we would have naturally received across day and night (Knoop et al. 2019). For the past seven decades, the exposure to electric light has increased between 3% and 6% annually as people are mostly indoors that consequently may increase the likelihood of disrupting the circadian rhythms (Kyba et al. 2017). In recent years, the work landscape has changed dramatically, as companies have started to cut costs by downsizing their office spaces and allowing their employees to work-from-home (WFH). The number of people remotely WFH surged by 173% from 2005 to 2018 (Messenger 2019). The pace of this change is increasing as a direct result of the COVID-19 pandemic, as currently, an ever-increasing number of people are WFH. Studies show strong

links between an irregular natural day-night cycle and disruption of circadian rhythms, poorer sleep quality, impairment of cognitive function, and the onset of depression in office workers without or with less access to natural light (Mariana G Figueiro 2017). Therefore, it has never been more important to capture evidence from human interactions within existing buildings and investigate the impacts of indoor lighting conditions on human health, comfort, and wellbeing. Currently, there is a lack of consensus on circadian lighting metrics and/or the exact threshold to support circadian-effectiveness of lighting in working environments. Some standards in the field of light and lighting such as, WELL Building Standard v2 (SEMINAR 2020), have recently begun to include metrics that address the proper light exposure for supporting biological health and adjusting the circadian rhythm with a natural day-night cycle. The WELL standard recommends using the two most popular circadian lighting metrics for measuring light exposure: Equivalent Melanopic Lux (EML) and Circadian Stimulus (CS). The effect of light exposure on the circadian system should be calculated by taking into account the output of all three types of retinal photoreceptors, rods, cones, and ipRGCs, in the human eye (Hattar et al. 2003). CS not only considers both spectrum and intensity of light source, but also it ties to all three types of retinal photoreceptors which is necessary for assessing circadian lighting (M. Rea and Figueiro 2018). However, EML ties to a single photoreceptor and ignores any impacts of the rods and cones. In this study, we used CS to measure the circadian-effectiveness of light using the collected data from the wearable spectrometer. Tailoring indoor lighting conditions in accordance with individuals' specific needs and desires can promote health and wellbeing in the built environments. Previous studies suggested we consider at least six factors (timing, duration, history, intensity, spectrum, and directionality of light exposure) when assessing the effects of light beyond vision (Juliëtte van Duijnhoven, Aarts, and Kort 2020). The spectrum and intensity of the light exposure need to be aligned with the human circadian system throughout the day to avoid circadian disruption and enhance human health and productivity. For example, exposure to light in the early morning advances the timing of the circadian clock; however, receiving bright light during the evening delays the timing of the biological clock and may cause circadian disruption which consequently reduce sleepiness (Ruger et al. 2006). Thus, people who spend a large proportion of the day under electric light, expose themselves to steady light intensities and spectrum, specifically during the evening/night hours, which may shift the human biological clock (Münch and Bromundt 2012). In the field of architecture and lighting design, different metrics, techniques, and devices need to be utilized other than what traditionally have been used by lighting designers to address human's biological needs for light. In this way, wearable technologies can be used to measure personal light conditions continuously in its most comprehensive forms (Spectral Power Distribution of light), which is essential for the lighting community. Recently, the term "personal lighting conditions" was commonly used when measuring lighting conditions continuously at the individual level (Juliëtte van Duijnhoven, Aarts, and Kort 2020). The inclusion of this term is recommended, particularly in studies that investigate the non-visual effects of light on humans (J van Duijnhoven et al. 2018). The objective of the present study was to measure personal lighting conditions of two-office workers continuously over the course of eight days in a home-office using a recently developed wearable spectrometer. We used CS to evaluate the circadian effectiveness of various lighting conditions during the study period. We further explore the effect of work schedules in response to light exposure between two office workers.

1.0 METHOD

We conducted a field study using a novel wearable spectrometer to measure participants' light exposures continuously in a home-office over a period of eight days in Seattle, WA. In the following sections, the process of collecting and analyzing the data, and the instrument used for the purpose of data collection are described in detail.

1.1. Test space selection criteria and participants

Data collection was performed at a home-office, which is on the third floor of a residential building located at Seattle, WA. Fig 1 shows the schematic plan of the home-office and its surrounding urban context. The home-office has five separate spaces including a working space, a kitchen, a bathroom, a living room furnished with a TV for resting time, and a bedroom for sleep at night. The working space had one West-side window that was covered with a venetian blind. Except for the distance to the window, we attempted to minimize the variation between the features in participants' working spaces. Features are similar for both participants included: room size; wall and furnishing color; siting orientation; amount and placement of furniture and luminaire; size, building orientation, and blind condition of the window (as well as size, number, and the height of the monitors). The living room had a west-facing window with a fully closed blind during the period of this study and there was a small source of lighting coming from a TV that can be ignored. The bedroom had an east-facing window that was covered during the nighttime by a fully closed blind, because this space was only used for sleep. We chose Seattle as it is the cloudiest major US city in the lower 48 states (Walker 2010). On average, Seattle has 226 days (62% of days) with clouds covering more than three-quarter of the sky and 308 days (84% of days) with clouds covering over one-quarter of the sky in a year. Thus, with less sunny days, there is limited access to daylight as an ideal source of light for the human circadian system. The length of the day varied significantly in Seattle over the course of the year. The present study was conducted between September 27 and August 4 when sunrise was at about 07:00 and sunset was at around 19:00 with a total daylight of less than 12 hours. Two office workers (one male: age 36 years and one female: age 36 years) volunteered for the study.

1.2. Lighting Interventions

We built a custom luminaire for the study using one ilumi BR30 Bluetooth LED Smart bulb ("Ilumi" Retrieved February 20, 2021) that was inserted into a luminaire head on the ceiling of the working space to be only used during Day 7 and

Day 8 of the study. A warm LED (2700 K) was used between Day 1 and Day 6 that was replaced with a new ilumi BR30 Bluetooth LED Smart bulb. The color temperature of this multicolor light source is adjustable from 2700 K to 6500 K, at nearly any brightness level. The ilumi app was used to automatically turn the light source on at 7 AM and turn it off at 11 PM between Day 7 and Day 8. To improve the daily routine, an additional layer of control, which is called “Circadian Experience” was used to schedule lighting brightness and color setting depending on the time of day in accordance with human circadian rhythm. The lighting automatically transitioned gradually from cool energetic white (6500 K) in the morning to a relaxing warm (2700 K) in the evening. The Circadian Experience was utilized to replicate the natural light cycle. The luminaire was placed in the middle of the working space to have the equal effect on both participants.

1.3. Data Collection and Protocol

A wearable spectrometer was used to collect Spectral Power Distributions (SPD) every 30 seconds from the participants. The process of calibration and the accuracy of the device can be found in a prior publication (Amirazar et al. 2021). We provided the required materials and instructions to participants prior to commencement of the study. We asked participants to wear the wearable spectrometer as a pendant (at chest height) for eight consecutive days during data collection periods. The device attached to the participants’ clothes at the left-hand side of the chest and measured light exposure at the similar view direction of the eye in the vertical plane. We asked participants to keep the wearable spectrometer always uncovered. Each participant wore a device during waking hours and placed the device next to their bed at the charging station during sleep. Participants had different working schedules as one started working at 7 AM (± 30 minutes) and the other one from 11 AM (± 30 minutes), but they went to bed at the same time (11 pm).

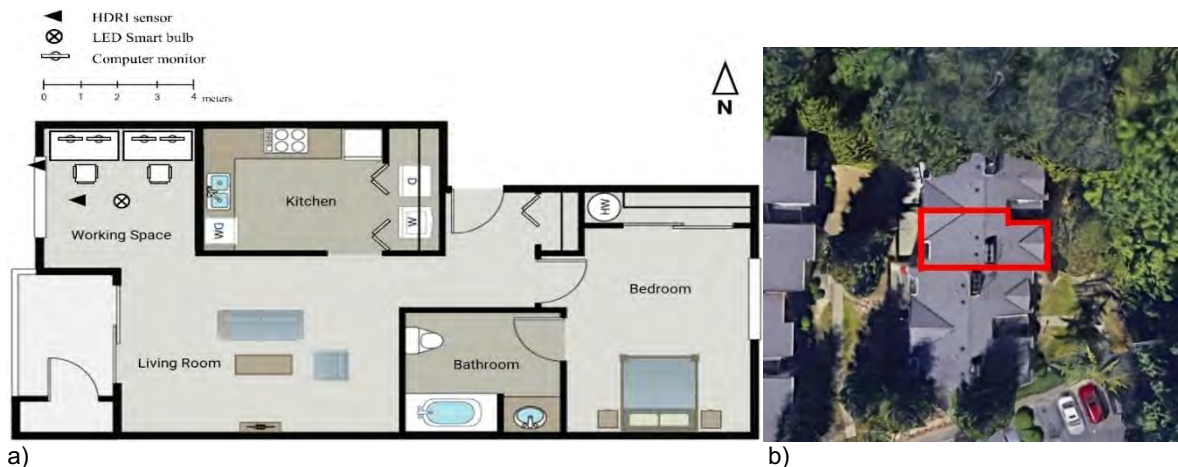

Figure 1: Example of home-office layout. a) plan shows where the subjects were seated, positions of computer monitors, LED smart bulb, and locations and view orientations of HDRI sensors, b) surrounding urban context.

To compare light-dark patterns between the two participants, we asked participants to keep a log of their bedtimes, waketimes (waking hours), and working times (when they are behind the desk) during the data collection period. To evaluate the circadian efficacy of different indoor lighting conditions, we designed different lighting conditions for each day of the data collection period (see Fig. 2). Fig 2 shows the protocol designed for the present study. The study was performed over eight days. From Day 1 to Day 5, the participants had freedom to close the blind if they experience excessive direct sunlight entering from the window or open it if they need more daylight in the working area. Additionally, the participants had freedom to turn on/off a warm LED (2700 K) placed in the middle of room. During day 6, the blind was fully retracted, and electric light was kept off to record the lighting conditions in the working space entering from the West-facing window. During day 7, we turned on the ilumi BR30 Bluetooth LED Smart bulb in the working space and closed the blind to investigate the effects of lighting intervention. Finally, during day 8, the blind was fully retracted, and ilumi BR30 Bluetooth LED Smart bulb was turned on to allow for both natural light and electric light in the working space.

	Day 1	Day 2	Day 3	Day 4	Day 5	Day 6	Day 7	Day 8
Wearable device	Wear	Wear	Wear	Wear	Wear	Wear	Wear	Wear
Lighting Intervention	Off	Off	Off	Off	Off	Off	On	On
Blind	Adoptable	Adoptable	Adoptable	Adoptable	Adoptable	Fully retracted	Fully closed	Fully retracted

Figure 2: The eight-day protocol for the study.

1.4. Analysis of measured SPD data

We employed a mathematical model of human circadian phototransduction proposed by Rea et al. to calculate Circadian Light (CL_A) and Circadian Stimulus (CS) for any spectral irradiance distribution (M.S. Rea et al. 2005; M.S. Rea et al. 2012). The CL_A metric is weighted irradiance of light incident at the cornea to reflect the spectral sensitivity

of the human circadian system. Additionally, the CS metric is determined by how much melatonin is suppressed by nocturnal lighting after one-hour light exposure from threshold (CS = 0.1) to saturation (CS = 0.7) to reflect the absolute sensitivity of the circadian system (M.S. Rea et al. 2010). We used MATLAB to analyze each SPD collected from the wearable spectrometer to calculate circadian light (CL) and circadian stimulus (CS). First, we converted the corneal SPD into CL_A , and then, second, CL_A is transformed into CS. CS metric was employed to quantify the effectiveness of corneal spectral power distribution in order to stimulate the human circadian system. It should be noted that a new light measurement strategy is currently recommended to report corneal spectral irradiance in five illuminance quantities by calculating the effective irradiance for rhodopic, melanopic, cyanopic, chloropic and erythroic independently (CIE 2018). However, currently, there is a lack of biological lighting metrics that utilize these five illuminance quantities for the purpose of assessing the lighting conditions in indoor environments. Therefore, we reported the results in units of CS, as the WELL Building Standard recently recommended this unit of analysis (SEMINAR 2020). We analyzed the data collected from the wearable spectrometer to compare the total light exposure among all eight days for both participants. As we only altered the lighting conditions in the working space, we analyzed the collected data based on the time participants spent in this space (working hours) to better understand the circadian effectiveness of different lighting conditions. Moreover, we analyzed the data from the wearable spectrometer to assess the total light exposure during both working hours and the total light exposure during waking hours for each participant. We calculated the total light exposure during both working hours and waking hours based on the times participants reported being at the working space and being awake, respectively. Additionally, we went one step further to analyze the light exposure on hourly basis during both working hours and waking hours and for different parts of a day, which included Morning (0600-1200), Afternoon (1200 - 1700), Evening (1700 - 2000), and Night (2000 - 0600). This helped us to better understand the circadian stimulus potential of light for each participant during his/her waking and working hours within different hours and different parts of the day. It is important to note that each participant has a different schedule, so the working hours and waking hours of each participant differ from that of the other.

1.5. Statistical Analysis

Statistical analysis was performed with SPSS Version 27. statistical software package (IBM, Armonk, NY, USA). A one-way ANOVA was conducted on light exposure data with the factors 'days' (eight days: day 1, day 2, day 3, day 4, day 5, day 6, day 7, and day 8) to determine effects of the light intervention across the eight-days study period. Tukey's post hoc analysis was further applied to compare the significant main effects and interactions of attributes where significant differences were found in ANOVA. A two-way ANOVA was conducted to explore how the participant's schedule (3 states: sleep, waking, and working) and daytime periods (4 parts: 6 a.m-12 p.m. = morning, 12 p.m-5 p.m. = afternoon, 5 p.m-8 p.m. = evening, and 8 p.m-6 a.m. = night) affect light exposure (CS) over the period of the study. Results were considered to be statistically significant when $p < 0.05$.

2.0 RESULTS

2.1. Monitoring the variations of outdoor lighting conditions

As shown in Fig 3, we monitored the outdoor lighting conditions by utilizing two low-cost and programmable High Dynamic Range Image (HDRI) sensors consisting of Raspberry Pi microcomputers with a 5-megapixel fisheye lens with a 180-degree field of view (FOV) to provide the visual record of interior and exterior scenes at the working space. We applied a false color luminance mapping on each HDR to visualize the luminance distribution of the window-facing view and exterior scene and to monitor any variations of outdoor lighting conditions during the study period from 08:00 to 19:00 between September 27 and August 4. Comparison between Day 1 and Day 8 of exterior scenes (Fig 3b) shows outdoor lighting conditions were almost the same among all eight days with a clear sky with no cloud cover. For the window-facing view of the interior scenes, Fig. 3a shows a significant decrease in window light exposures during Day 7 compared to Days 7 and 8, as the blind was fully closed for the entire day. Closer inspection of Fig. 3a shows that the participants closed the blind mostly during afternoon between Day 1 and Day 5 to reduce the excessive sunlight entering from the window. During Day 6 and Day 8, the blind was fully retracted for the entire day.

2.2. Exploring the circadian effectiveness of various lighting conditions

Circadian stimulus (CS) was estimated by analyzing SPD collected from the wearable spectrometer worn by the participants. Figs. 4-6 summarize the outcomes in terms of the mean CS level over the eight-days study period grouped into the entire day, working and waking hours, and daytime periods. As expected, the one-way ANOVA revealed significant differences in CS values for the study days, $F(7, 43261)=163.665$, $p<0.001$. *Post-hoc* analysis using the Tukey HSD model show significant ($p<0.001$) difference in mean CS levels between two intervention days (Day 7 (M = 0.12, SD = 0.19), and Day 8 (M = 0.14, SD = 0.21)) and the first six days. Fig. 4 shows two intervention days (Day 7 and Day 8) had the highest CS value compared with other study days. As shown in Fig. 5 the mean CS level dramatically increased from Day 6 to Day 8 during both waking hours and working hours. For different daytime periods, there is a surge in mean CS level from Day 6 to Day 8 during morning and evening, except for afternoon as there was a slight decrease from CS = 0.31 to CS = 0.3 between Day 7 and Day 8, respectively (Fig. 6).

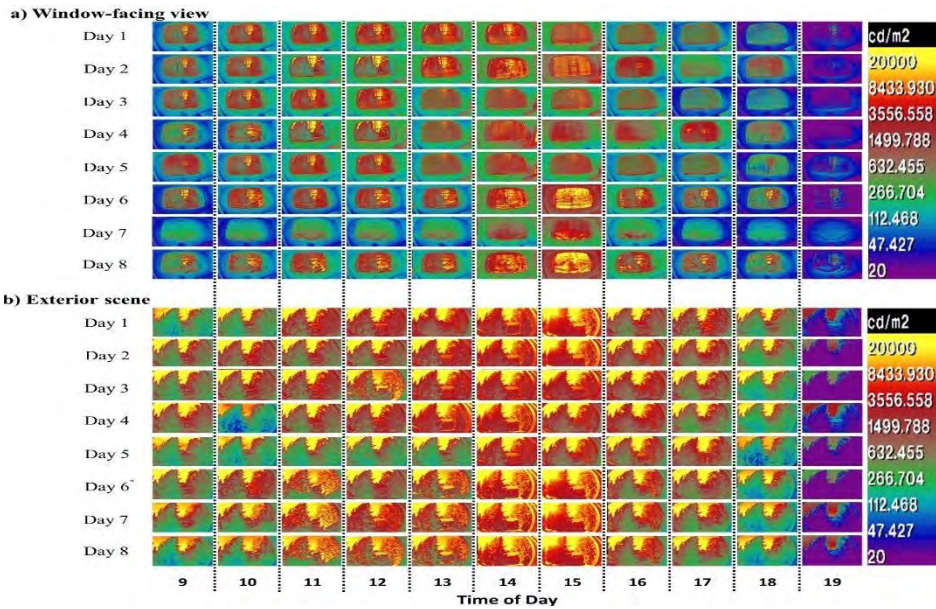

Figure 3: False Color luminance mapping of a) window-facing views and b) exterior scenes from 09:00 to 19:00 between Day 1 and Day 8.

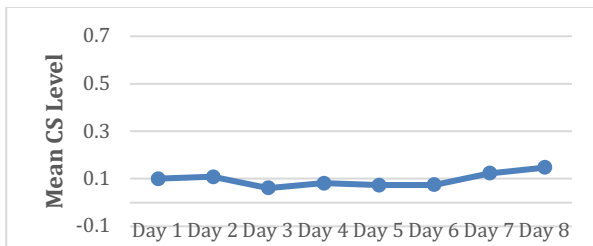

Figure 4: Mean CS values measured for an *entire day* for each study day. The error bars represent the standard error of the mean

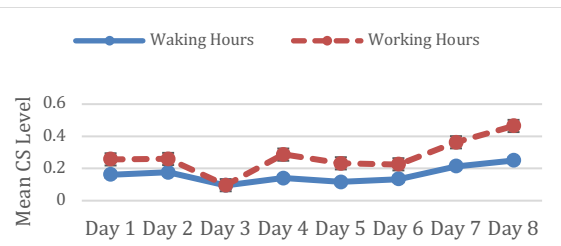

Figure 5: Mean CS values measured during *working hours and waking hours* for each study day. The error bars represent the standard error of the mean

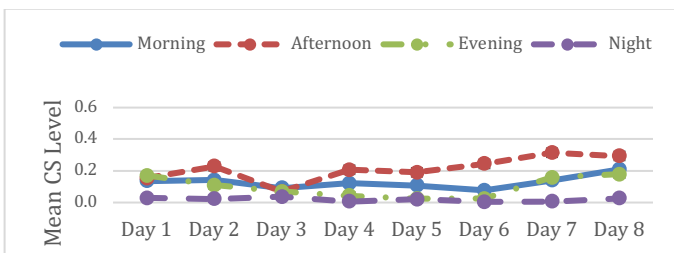

Figure 6: Mean CS values measured during *different daytime periods* for each study day. The error bars represent the standard error of the mean

2.3. Exploring personal lighting conditions per individual

Fig. 7 presents daily schedule of both office workers for all eight-day study period. Each participant self-reported his/her daily schedules and locations during the entire study period. Participants had different sleep-wake schedules (blue and grey cubes) and working schedules (orange cubes) during the study. As shown in Fig. 8, the average reported duration of working hours were 345 minutes (SD = 140) and 315 minutes (SD = 138) for participant 1 and participant 2, respectively. The sleep-wake schedule of each participant was different from one another. The average reported duration of waking hours were 960 minutes (SD = 30) and 720 minutes (SD = 50) for participant 1 and participant 2, respectively. In general, participant 2 had longer sleep duration by approximately 12 hours compared with 8 hours for participant 1. It should be noted that participant 2 was not presented in the working area during Day 3. Figs. 8-11 can be used to understand the significant impact of individual differences between participants on measured light exposure data reported in units of CS. Figs. 8-10 compared the measured levels of CS between two participants during each study day, waking hours, and only working hours over the duration of the study. The two-way ANOVA revealed significant main effects of the participant's schedule, $F(2, 43130)=4697.851, p<0.001$. The mean CS level increased from Day 6 to Day 8 for both participants. Fig. 10 shows mean CS values was significantly higher for participant 2 during all study period (CS > 0.3), except Day 3, compared with participant 1. Fig. 11 presents the mean CS level for

four different daytime periods acquired by taking light exposure data of each participant over the duration of the study. There was a significant main effect of daytime periods, $F(3, 43130)=203.431, p<0.001$. For participant 2, mean CS level increased between morning and afternoon, followed by a decrease towards the night during all eight-study days, except an unexpected surge on mean CS level during evening on Day 7. For participant 1, mean CS level decreased from morning to night during all three-study days, expect a slight increase between afternoon and evening on Day 1 and Day 8 and an unexpected increase from morning to afternoon on Day 5.

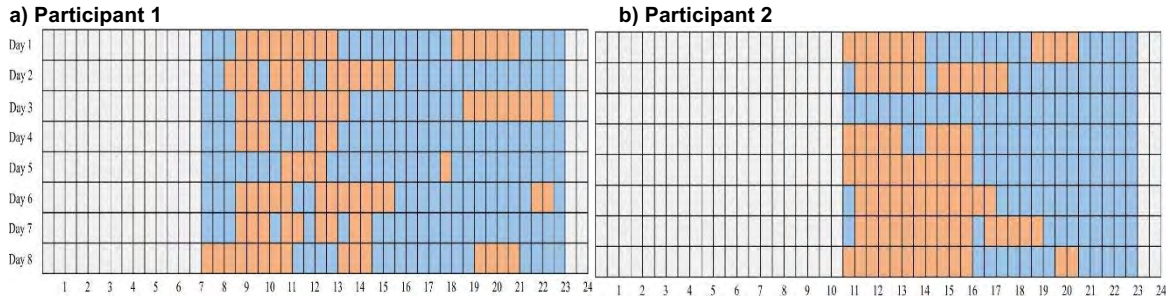

Figure 7: Participant profiles and their daily schedule and locations for all eight-day study period. Orange, blue, and grey cubes indicate the hours when each participant was working, waking, and sleeping, respectively.

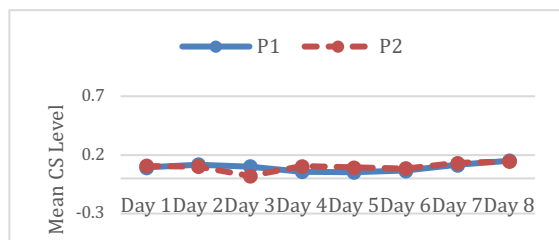

Figure 8: Mean CS values measured at the chest of each participant for an entire day. The error bars represent the standard error of the mean.

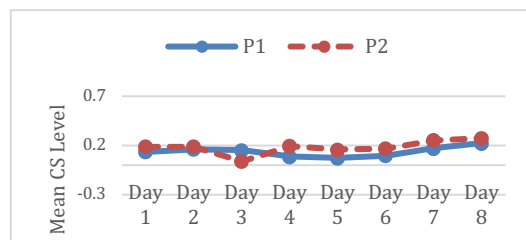

Figure 9: Mean CS values measured at the chest of each participant during waking hours. The error bars represent the standard error of the mean.

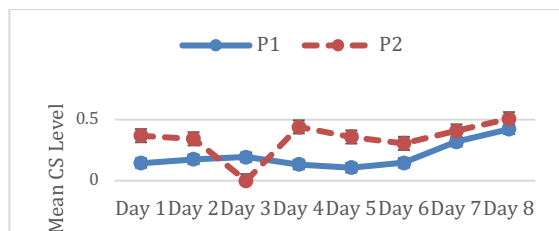

Figure 10: Mean CS values measured at the chest of each participant during only working hours. The error bars represent the standard error of the mean.

DISCUSSION AND CONCLUSIONS

This research assessed the practical applicability of an affordable and wearable spectrometer in the context of aiding individuals to have healthier living with relation to light. In this study, the circadian-effectiveness of light was measured in terms of CS across the eight-day study period. Previous studies showed that the office workers who received $CS \leq 0.15$ in the morning had difficulty sleeping at night with higher levels of depression compared to those who received $CS \geq 0.3$ in the morning (M. G. Figueiro et al. 2019; M. G. Figueiro et al. 2017). Hence, in the present study, $CS \geq 0.3$ is considered as a high circadian-effective light level that reduces sleepiness and improves energy and alertness in office workers. It should be noted that on each day of the study, the same wearable spectrometer was used by each participant. We evaluated the circadian effectiveness of lighting during a two-day intervention (Day 7 and Day 8) following the baseline between Day 1 and Day 6 for two office workers. The findings show a significant difference between the first six days and, Days 7 and 8 in terms of CS value that indicated the potential of utilizing dynamic electric lighting in combination with daylight to have a significant impact on circadian stimulus potential of indoor lighting. As expected, participants were exposed to higher amounts of circadian-effective light during working hours compared to waking hours (Fig. 5). CS values during waking hours for the two intervention days were above 0.2 (see Fig. 5). We found that the two office workers received high circadian-effective light level ($CS \geq 0.3$) while at work (during working hours) on intervention Day 7 and Day 8 compared to baseline days (Fig. 5). The average CS value for both participants was 0.37 on Day 7, followed by a considerable increase to 0.45 on Day 8. Increasing circadian stimulation during Day 8 was because of access to a mixture of daylight and electric light compared to Day 7 where electric light was the only source of lighting.

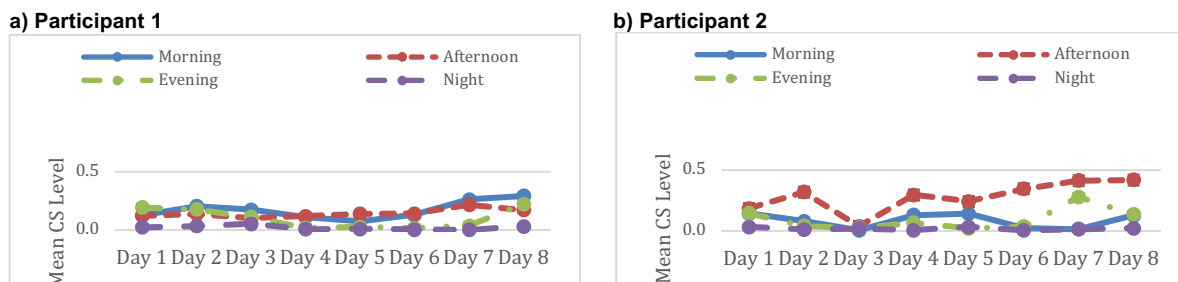

Figure 11: Mean CS values measured at the chest during different daytime periods for a) participant 1, and b) participant 2. The error bars represent the standard error of the mean

The importance of daylight and its impact on improving the level of circadian-effective light in indoor spaces is comparable to the studies presented by (Konis 2018) and (Boubekri et al. 2014) who showed the benefits of daylight spaces in comparison with windowless environments in regard to increasing circadian stimulation. Participants were exposed to a significantly higher amount of circadian-effective light in the afternoon for most of study days compared to other daytime periods (Fig. 6). The fact that the mean CS value increases during the afternoon can be explained by the larger proportion of time that both participants spent at their working space with higher circadian-effective light levels compared to other spaces such as the living room and bedroom (see Fig. 7). Even though we performed this study in summer 2020 and we only have two participants doing the same job tasks in the same location, we still found large individual differences between two participants in their personal lighting conditions. These differences between the personal lighting conditions of two participants may be explained by mixed physiological/behavioral differences and workspace characteristics such as different wake/sleep patterns, work schedules and distance to window. As mentioned in section 2.1, the variation between workspace characteristics were minimized for both participants. Variations as siting orientation, amount and placement of furniture and luminaire, size of the building, building orientation, blinds and condition of window coverings, as well as the size, number, and the height of the monitors were similar for both participants. Despite the fact that the study was performed on sunny days during the summer season, both office workers were generally being exposed to low circadian-effective light level ($CS \leq 0.3$) during waking hours (Fig. 9). We can speculate on a few reasons why the measured amount of circadian light for both participants for the entire day (Fig. 4) and during waking hours (Fig. 5) on all eight study days was low. One is due to the building design, a narrow facade and a small window-to-wall ratio that had been poorly designed to provide enough daylight availability in the space (Fig. 1). Another is due to the building orientation, as the West-facing window had only about two hours of direct sunlight (Fig. 3), while the East-facing window did not provide enough daylight availability for even the bedroom during the daytime period. The third reason would be due to the lack of enough number, placement, intensity, and spectrum of electric lighting that were installed in the building where less daylight is available. As expected, distance from the West-side window at the working space was found to be associated with a difference in participants' lighting conditions. Except for Day 3, the average CS values during working hours for participant 2 was above 0.3 (Fig. 10). In contrast, for participant 1, the average CS values during working hours was above 0.3 only on two intervention days (Day 7 and Day 8). As shown in Fig. 10, a 2-meter increasing distance to the West-facing window resulted in a significant increase in the mean CS level between Day 6 and Day 8 when daylight was the source of light for the working space. The fact that the CS level reduces for an increasing distance can be explained by the limited penetration depths of daylight in a room (Iversen et al. 2013). These results are consistent with previous studies showing distance-to-window has a significant impact on the personal lighting conditions (Juliëtte van Duijnhoven et al. 2020), particularly the amount of circadian-effective light that participants were exposed to during daytime (M. G. Figueiro and Rea 2016). These findings highlight the importance of considering the impact of distance to window when measuring the personal lighting conditions within daylit spaces. The difference in personal lighting conditions between two participants was also found and can be impacted by changing the sleep-wake schedule and working schedule of the office workers. As already mentioned in section 2.6, the working hours and waking hours were calculated in terms of the amount of time each participant spent at the working space and being awake, respectively. Although participant 2 woke up about 4 hours later than participant 1, the percentage of time spent at the working space was much higher compared to participant 1 (Fig. 7). Participant 2 received a higher amount of circadian-effective light in the afternoon compared to other daytime periods during all eight-day study periods, except Day 3 when participant 2 was not presented in working area for entire day (Fig. 11). However, participant 1 was exposed to the highest level of circadian-effective light in the morning for intervention Day 7, and Day 8. Additionally, a low CS level on Day 4 and Day 5 compared with other study days for participant 1 can be explained by the lower number of working hours during these days (see Fig. 7). Similarly, for participant 2, a considerable decrease in CS level on Day 3 was the results of significant decrease in the number of working. Future research is recommended to include the larger number of participants with different age groups, different jobs, different culture, and different genders to explore a more complete set of factors to better understand the actual lighting conditions at the individual level. The present study is the first to employ a low-cost and wearable spectrometer that allows us to measure light source's SPDs and store the collected data on the Firebase cloud database using wireless communication. The concept of a 'personalized smart lighting system' can be deployed by continuously monitoring personal lighting conditions in real-time using the developed spectrometer and controlling these lighting conditions by utilizing an IoT-based smart lighting system.

3.1. Limitations of the study and

First, due to the impact of COVID pandemic, we had a limited number of participants in this study. The small sample size does not allow us to investigate the inter-individual differences in response to light exposure between larger populations with different ages, genders, and jobs. Physiological, genetic, behavioral, and cultural differences between individuals may cause different biological responses even under the same lighting conditions.

REFERENCES

- Amirazar, Armin, Mona Azarbayjani, Maziyar Molavi, and Morteza Karami. 2021. "A Low-Cost and Portable Device for Measuring Spectrum of Light Source as a Stimulus for the Human's Circadian System." *Energy and Buildings*: 111386.
- Berson, David M, Felice A Dunn, and Motoharu Takao. 2002. "Phototransduction by retinal ganglion cells that set the circadian clock." *Science* 295 (5557): 1070-1073.
- Boubekri, M., I. N. Cheung, K. J. Reid, C. H. Wang, and P. C. Zee. 2014. "Impact of windows and daylight exposure on overall health and sleep quality of office workers: a case-control pilot study." *J Clin Sleep Med* 10 (6): 603-11.
- CIE, S. 2018. "026/E: 2018 CIE System for Metrology of Optical Radiation for ipRGC-Influenced Responses to Light." *CIE, Vienna*.
- Cordina-Duverger, Emilie, Florence Menegaux, Alexandru Popa, Sylvia Rabstein, Volker Harth, Beate Pesch, Thomas Brüning, Lin Fritschi, Deborah C Glass, and Jane S Heyworth. 2018. *Night shift work and breast cancer: a pooled analysis of population-based case-control studies with complete work history*. Springer.
- Figueiro, M. G., M. Kalsher, B. C. Steverson, J. Heerwagen, K. Kampschroer, and M. S. Rea. 2019. "Circadian-effective light and its impact on alertness in office workers." *Lighting Research and Technology* 51 (2): 171-183.
- Figueiro, M. G., and M. S. Rea. 2010. "Evening daylight may cause adolescents to sleep less in spring than in winter." *Chronobiology International* 27 (6): 1242-1258.
- Figueiro, M.G. and M.S. Rea 2016. "Office lighting and personal light exposures in two seasons: Impact on sleep and mood." *Lighting Research and Technology* 48 (3): 352-364.
- Figueiro, M. G., B. Steverson, J. Heerwagen, K. Kampschroer, C. M. Hunter, K. Gonzales, B. Plitnick, and M. S. Rea. 2017. "The impact of daytime light exposures on sleep and mood in office workers." *Sleep Health* 3 (3): 204-215.
- Figueiro, Mariana G. 2017. "Disruption of circadian rhythms by light during day and night." *Current sleep medicine reports* 3 (2): 76-84.
- Hattar, Samer, Robert J Lucas, N Mrosovsky, S Thompson, RH Douglas, Mark W Hankins, J Lem, M Biel, F Hofmann, and Russell G Foster. 2003. "Melanopsin and rod-cone photoreceptive systems account for all major accessory visual functions in mice." *Nature* 424 (6944): 75-81.
- "ilumi." Retrieved February 20, 2021. <https://ilumi.co/>.
- Iversen, Anne, Nicolas Roy, Mette Hvass, Michael Jørgensen, Jens Christoffersen, Werner Osterhaus, and Kjeld Johnsen. 2013. "Daylight calculations in practice: An investigation of the ability of nine daylight simulation programs to calculate the daylight factor in five typical rooms."
- Klepeis, Neil E, William C Nelson, Wayne R Ott, John P Robinson, Andy M Tsang, Paul Switzer, Joseph V Behar, Stephen C Hern, and William H Engelmann. 2001. "The National Human Activity Pattern Survey (NHAPS): a resource for assessing exposure to environmental pollutants." *Journal of Exposure Science and Environmental Epidemiology* 11 (3): 231.
- Knoop, Martine, Oliver Stefani, Bruno Bueno, Barbara Matusiak, Richard Hobday, Anna Wirz-Justice, Klaus Martiny, Thomas Kantermann, MPJ Aarts, and Nouredine Zemouri. 2019. "Daylight: What makes the difference?" *Lighting Research & Technology*: 1477153519869758.
- Konis, K. 2018. "Field evaluation of the circadian stimulus potential of daylight and non-daylight spaces in dementia care facilities." *Building and Environment* 135: 112-123.
- Kyba, Christopher CM, Theres Kuester, Alejandro Sánchez De Miguel, Kimberly Baugh, Andreas Jechow, Franz Hölker, Jonathan Bennie, Christopher D Elvidge, Kevin J Gaston, and Luis Guanter. 2017. "Artificially lit surface of Earth at night increasing in radiance and extent." *Science advances* 3 (11): e1701528.
- Mallis, Melissa M, and CW DeRoshia. 2005. "Circadian rhythms, sleep, and performance in space." *Aviation, space, and environmental medicine* 76 (6): B94-B107.
- Messenger, Jon C. 2019. *Telework in the 21st century: An evolutionary perspective*. Edward Elgar Publishing.
- Münch, Mirjam, and Vivien Bromundt. 2012. "Light and chronobiology: implications for health and disease." *Dialogues in clinical neuroscience* 14 (4): 448.
- Rea, Mark S, Mariana G Figueiro, Andrew Bierman, and John D Bullough. 2010. "Circadian light." *Journal of circadian rhythms* 8 (1): 2.
- Rea, Mark S, Mariana G Figueiro, Andrew Bierman, and R Hamner. 2012. "Modelling the spectral sensitivity of the human circadian system." *Lighting Research & Technology* 44 (4): 386-396.
- Rea, Mark S, Mariana G Figueiro, John D Bullough, and Andrew Bierman. 2005. "A model of phototransduction by the human circadian system." *Brain Research Reviews* 50 (2): 213-228.
- Rea, MS, and MG Figueiro. 2018. "Light as a circadian stimulus for architectural lighting." *Lighting Research & Technology* 50 (4): 497-510.
- Ruger, Melanie, Marijke CM Gordijn, Domien GM Beersma, Bonnie de Vries, and Serge Daan. 2006. "Time-of-day-dependent effects of bright light exposure on human psychophysiology: comparison of daytime and nighttime exposure." *American Journal of Physiology-regulatory, integrative and comparative physiology* 290 (5): R1413-R1420.
- SEMINAR, CPD. 2020. "The WELL v2 Building Standard and how floor covering impacts health and well-being."
- Thorne, Helen C, Kay H Jones, Stuart P Peters, Simon N Archer, and Derk-Jan Dijk. 2009. "Daily and seasonal variation in the spectral composition of light exposure in humans." *Chronobiology International* 26 (5): 854-866.
- van Duijnhoven, J, MJH Burgmans, MPJ Aarts, ALP Rosemann, and HSM Kort. 2018. "Personal lighting conditions to obtain more evidence in light effect studies." Congress of the International Ergonomics Association.
- van Duijnhoven, Juliette, Mariëlle PJ Aarts, and HSM Kort. 2020. "Personal lighting conditions of office workers: An exploratory field study." *Lighting Research & Technology*: 1477153520976940.
- van Duijnhoven, Juliette, Mariëlle PJ Aarts, Edwin R van den Heuvel, and Helianthe SM Kort. 2020. "The identification of variables influencing personal lighting conditions of office workers." *Lighting Research & Technology*: 1477153520976950.
- Walker, Liz. 2010. *Choosing a sustainable future: Ideas and inspiration from Ithaca, NY*. New Society Publishers.

Mapping Blindspots in Urban Atmospheric Pollution Assessment in the U.S.–Mexico Borderland

Stephen Mueller¹

¹Texas Tech University, El Paso, TX

ABSTRACT: Populations living in urban environments along the US-Mexico international border face significant environmental health challenges from atmospheric pollution in the next two decades due to the combined and disproportionate impacts of climate change, population growth, and urbanization in the borderland. Yet the region is underserved by atmospheric sensing and environmental regulatory frameworks that could identify emerging threats to urban populations. The investigative research seeks to identify urban neighborhoods in the borderland that are particularly under-represented by current environmental sensing networks, where large populations will face elevated levels of atmospheric pollution by 2050. Locations and common morphological features of these built environments are analyzed in order to suggest more equitable alternatives to the current spatial distribution of environmental sensors. Using Geographic Information Systems (GIS) software to visualize open-source datasets from regulatory agencies, researchers analyzed hundreds of borderland environmental sensor locations. By categorizing and symbolizing the range of atmospheric scales each sensor is designed to address (from smallest to largest: *microscale*; *middle scale*; *neighborhood scale*; *urban scale*; and *regional scale*), the research reveals the varying levels of resolution afforded to different urban populations in the US, and an asymmetric distribution of fine-scale assessment for large population centers in the borderland. Original “heatmaps” illustrate areas and degrees of investment for environmental sensing, providing evidence of low investment in microscale sensors in high-population border cities and relatively high levels of investment border-wide in regional scale sensors, with particular focus on federal land outside of urban areas. The border is thus relatively “dark” to fine-scale and “population oriented” sensors at the micro-, middle-, neighborhood, and urban scales. These unique transnational airsheds—and the populations living within them—will be better served with more equitable spatial distributions of atmospheric sensors.

KEYWORDS: urban geography, transboundary geography, mapping, computation, environmental justice

1.0 INTRODUCTION

1.1 Urban Environmental Health Challenges in the U.S.–Mexico Border Region

Significant environmental, climatic, and demographic shifts in the United States over the last several decades have produced new stressors on urbanized environments and urban populations nationwide. The southern border region is particularly challenged by significant rates of climate change, population growth, and urbanization, as well as their combined impacts. Climate change continues to reshape the border landscape and atmosphere, as desertification expands areas of arid soil and exacerbates seasonal dust storms in the region. With an increase in domestic migration to southwestern states, the population of the borderland has grown faster than the U.S. average over the last decade (SBCC, 2021). Steady population growth at the border over the past 80 years, accelerated by industrialization and bilateral trade agreements, has consistently outpaced national averages in both the U.S. and Mexico (PAHO, 2012). While the population living within 100 kilometers of the international boundary was estimated at 15 million people in 2017, that number is expected to double by the year 2025 (DHHS, 2017). The growing population is significantly altering land use and urban development, making the region one of the most rapidly urbanizing regions in the nation. While many cities throughout the region demonstrate evidence of these shifts, their impacts are concentrated in major and growing metropolitan areas. In 2012, around 84% of the border population was urban (PAHO, 2012). In recent years, the border has been home to two of the ten fastest growing metropolitan areas in the U.S.—Laredo and McAllen in South Texas (DHHS, 2017)—while existing border cities in the region—including the El Paso–Ciudad Juárez metroplex—continue to host large urban populations.

1.2 Unique Vulnerabilities of Urban Populations in the Borderland

While these stressors are particularly heightened in the borderland, their impacts on borderland populations will be further amplified due to existing vulnerabilities within the social and economic context, and the infrastructural capacities of the region. From an economic perspective, the rate of poverty in border communities on the whole is higher than national averages, with the disparity the greatest in Texas border communities (SBBC, 2021), including some of the major and quickly urbanizing areas noted above. Many border counties post unemployment figures significantly higher than national averages. Poor environmental health conditions are pervasive in the region. Border cities register levels of environmental air pollution higher than standard. Especially in self-settled areas lacking infrastructural investment in urban peripheries, residents have lower-than-average access to drinking water and sanitary sewers. These economic

and environmental conditions correlate with low levels of public health and health access. The population has evidenced lower life expectancy rates than national averages (PAHO, 2012). The percentage of the population without health insurance in U.S. border states has been lower than for the nation as a whole (PAHO, 2012). Over 70 percent of U.S. border counties are classified as medically underserved, while over 60 percent evidence a shortage of health professionals (Moya et. al., 2020). The borderline itself seems to exacerbate these issues. Populations living near U.S. ports of entry have been found to be exposed to greater environmental health hazards than those in other locations in the same city (Eades, 2018).

1.3 Assessing Environmental Injustice in Border Cities

From the issues described above, it is clear that, while the type of environmental health challenges facing cities near the U.S.–Mexico border might be shared with other cities in the U.S. or Mexico, the urgency of addressing these shared challenges is amplified within the border context. Despite this urgency, the border region continues to suffer from “environmental injustice,” or the “disproportionate negative impacts on socially marginalized people” (Grineski & Juárez-Carillo, 2012). There are many shared environmental injustices in the borderland. There are also threats unique to particular environments. The borderland, spanning the continent, is not a homogeneous entity—it is a vast region with a diverse population and varying social, economic, geographic, and environmental conditions. Assessment strategies must be developed conditional on each border city’s particular context.

Many regulatory frameworks exist to monitor and assess environmental conditions at the border, but changing federal, state, and local priorities can problematize consistent, accurate, and timely assessments (Coronado & Mumme, 2020). To alleviate the continued undue environmental and public health burdens on borderland populations, there is a need to investigate several pressing questions: whether adequate resources are dedicated to environmental assessment, whether these systems are capable of meeting the substantial and diverse needs of urban populations in the borderland, and whether the data and analysis provided is adequate in service of these populations.

2.0 BACKGROUND: ENVIRONMENTAL AIR QUALITY ASSESSMENT IN THE BORDERLAND

2.1 Factors Contributing to Poor Environmental Air Quality in the Borderland

One of the most significant and pervasive environmental health issues in the borderland is poor environmental air quality. Arid terrain throughout the borderland, coupled with mountainous geography and the dynamics of airflow conspire to produce atmospheric “inversions,” trapping smog and dust and fostering pervasive atmospheric pollution conditions in many border cities. Some of the largest border metroplexes, including El Paso–Ciudad Juárez, are thus described as “air pollution catchment areas” (Heyman, 2017). With continued pollution generated by industrial processes, idling cross-border traffic, dust transfer from nearby desert landscapes, and other anthropogenic impacts, large populations in this and other border city regions will face elevated levels of atmospheric pollution by 2050.

2.2 Geographic Considerations for Locating Atmospheric Sensors

U.S. federal regulations dictate protocols for the selection of sites to deploy ambient air quality sensors for the national air monitoring network (EPA, 2020), noting a need to balance available resources with a desire for appropriate resolution, or *scale of representativeness* obtained from the sensor. Within a given country, the scales of representativeness are, from smallest to largest: *microscale* (with resolution from a few meters up to 100m), *middle scale* (from 100m to 0.5km resolution), *neighborhood scale* (from 0.5km to 4.0km resolution), *urban scale* (from 4.0 to 50km resolution), and *regional scale* (up to hundreds of km resolution) (CFR, 2021).

Environmental agencies will deploy a given scale of sensor on a given site, depending on many interrelated factors, including: which pollutants they intend to monitor; what scale of transport they are studying; whether they believe the site to be a source of the contaminant; as well as the location upwind, downwind, or on-site of human populations likely to be affected by aerial contaminants. The selection of a sensor at a given scale assumes that the level of a given airborne pollutant within an “air parcel” at that scale is “reasonably homogeneous” (CFR, 2021). Each sensor network tasked to monitor a given phenomenon can thus be evaluated periodically. Anomalous readings within the network are meant to signal a need for additional sensors or increased resolution to locate particular threats, while consistent readings over large areas might signal a redundancy of sensors amidst relatively stable situations, resulting in shuttered stations and lower-resolution output.

2.3 Shortfalls of Atmospheric Monitoring in Vulnerable Urban Neighborhoods

Many urban neighborhoods within the borderland are underserved by existing sensor networks. The limited number of high-quality and high-cost sensors deployed in a metropolitan region, and the limited tasking of national sensors for regional-scale readings often results in the sensors placed far from vulnerable neighborhoods, which may be seen as outliers for statistical averages (Kripa & Mueller, in-press). Sensors that are part of regulatory assessments in general have suffered from *inconsistent maintenance*, thereby negatively impacting the continuity of operations and reliability of steady streams of sensor data. The relatively large *spatial resolution* of most existing sensors may elide distinctions between neighboring urban environments, flattening out the differences in air quality that are otherwise perceptible street by street, or block by block. The *temporal resolution* of available sensor data, often collected and reported every hour or half-hour, may not be capable of detecting and recording significant pollution events or dust events that can

enter and leave an airshed more quickly. Lower-cost devices that are affordable for smaller spatial and temporal scales are often of lower quality and may not provide verifiable results vulnerable communities would need to advocate for improved conditions. While these sensors may help a growing number of communities to detect conditions that significantly endanger the health of their residents, data from these low-cost sensors are not accepted as adequate evidence by regulatory agencies empowered to mandate improvements to environmental health (Mueller & Kripa, in press). Verifiable data produced by existing sensor networks is not always readily available or easily accessible except to experts or owners of proprietary systems.

2.4 Common Morphological Features of Urban Neighborhoods with Poor Atmospheric Air Quality

While border cities are themselves more susceptible to deleterious effects of poor environmental air quality based on their geographic conditions, certain neighborhoods within those cities are even more at risk. Nuances in the local geography, the physical characteristics of the built environment, and microclimatological effects can impact the amount of airborne pollution suspended within the neighborhood, and increase the length of time the population may be exposed. Features influencing the amount of suspended particulate include the condition of buildings and roads. Unpaved roads, for instance, are a large contributor to suspended fine particles, while congested roads contribute to truck exhaust and brake dust. Features impacting exposure time include the position of the neighborhood relative to geographic features like mountains and valleys that may create static airflow conditions, and the density and orientation of the buildings relative to prevailing winds.

3.0 OBJECTIVES

3.1 Identify blindspots in existing atmospheric sensor networks

To begin, the research set out to identify “blindspots” within the current atmospheric sensor network—areas including city regions and metropolitan areas that are under-represented by the current sensor deployment. From this assessment the research seeks to gauge whether individual border cities are adequately served, whether the territory of the borderland is adequately served, and if there are any assessment disparities amongst border cities, or between border cities and other cities outside the borderland. This article will focus mostly on this stage of the research.

3.1 Identify urban neighborhoods in borderland under-represented by atmospheric sensors

The research suggests, as a long-term goal, mapping methods to identify urban neighborhoods in the borderland that are particularly vulnerable to persistent poor environmental air quality yet under-represented by the current deployment of atmospheric sensors.

3.2 Suggest criteria that would support more equitable distribution of sensors

The research suggests, as a second long-term goal, to establish criteria to support the more equitable distribution of sensors, thereby reducing or eliminating the disparities in the amount, quality, and access to data available to previously underserved urban neighborhoods.

4.0 4.0 METHODS

4.1 Geographic Information Systems (GIS)

The author(s) began by compiling locational data and associated data for currently-fielded air quality monitoring stations nationwide. The data was downloaded from publicly available GIS service layers published by the Environmental Protection Agency (EPA, 2020).

4.2 Representing Scale of Sensing

The author(s) then set out to develop mapping techniques to translate the locational data and the range each sensor was capable of sensing. A series of iterative maps was developed as test cases to highlight and document the multiple scales of environmental air quality assessment, developing representational techniques to translate the numeric information (including range and density of sensors) with geographic and jurisdictional features (Figure 1). Using the border sister cities of San Diego–Tijuana as a graphic reference, a series of visualizations were made at increasingly finer scale. Each visualization shows the location of sensors operating at a given scale within the given range. The maximum range of each sensor type is captured in the scale and centering of each of the maps, with the circular extent of the map corresponding to the maximum range. The maps then use the point features of each sensor location to extrapolate the coverage of each station. Using the standard range for the sensor type as an input, a “heat map” layer is added to each collection of sensor points, indicating the anticipated, combined coverage of the collection of sensors.

4.3 Active Sensor Location Mapping

Expanding these strategies to maps at the national scale, a series of nationwide heatmaps of active sensor locations as produced (Figure 2) showing concentrations of different sensor types including: a) regional, b.) urban, c.) neighborhood, d.) middle and e.) micro scale. Dark areas in these maps indicate blindspots in environmental monitoring at each scale.

4.4 Composite Sensor Location Mapping

The individual maps were then composited by weighting the value of individual layer proportionally to the scale of sensing, and superimposing the multiple layers in a single map. Dark areas in this composite map indicate blindspots in overall environmental monitoring nationwide.

5.0 RESULTS

5.1 Visualizing Uneven Investment

From the individual maps of active sensor locations at each scale, we note a relatively low level of investment in microscale sensors nationwide, and a relatively high level of investment in regional scale sensors. With the large investment in sensors that cover a larger area, and the range of the sensors, nationwide coverage at the regional scale is more even than nationwide coverage of other scales, which are more unequally distributed and centered mainly around large metropolitan areas. Outside of urban areas, coverage is apparently most intense on or near federal lands.

5.2 Significant Monitoring Deficits for Populated Areas Along the US–Mexico Border

While sensor distribution is most dense in the urbanized areas of the borderland, the borderland is relatively underserved at most scales of sensing and overall. The land border between the U.S. and Mexico stands in stark contrast to other national borders in the map. There are more deployments of regional scale sensors in coastal areas, especially in large U.S. cities and city regions near large Canadian cities, suggesting investment priorities are focused on assessing and managing transborder flows in those regions more so than their U.S.-Mexico counterparts. The southern border does appear to be additionally served by regional sensors protecting national parks.

But borderland populations are not as well-served. Border cities are host to fewer sensors than other metropolitan areas in the nation. The border is relatively "dark" to fine-scale and "population oriented" sensors at the micro-, middle-, neighborhood, and urban scales, leaving significant borderland cities and their populations underserved. Even at the higher resolution of state-managed and regionally-managed sensing networks, the U.S.–Mexico border, and the El Paso–Ciudad Juárez border region in particular, is subject to several blindspots.

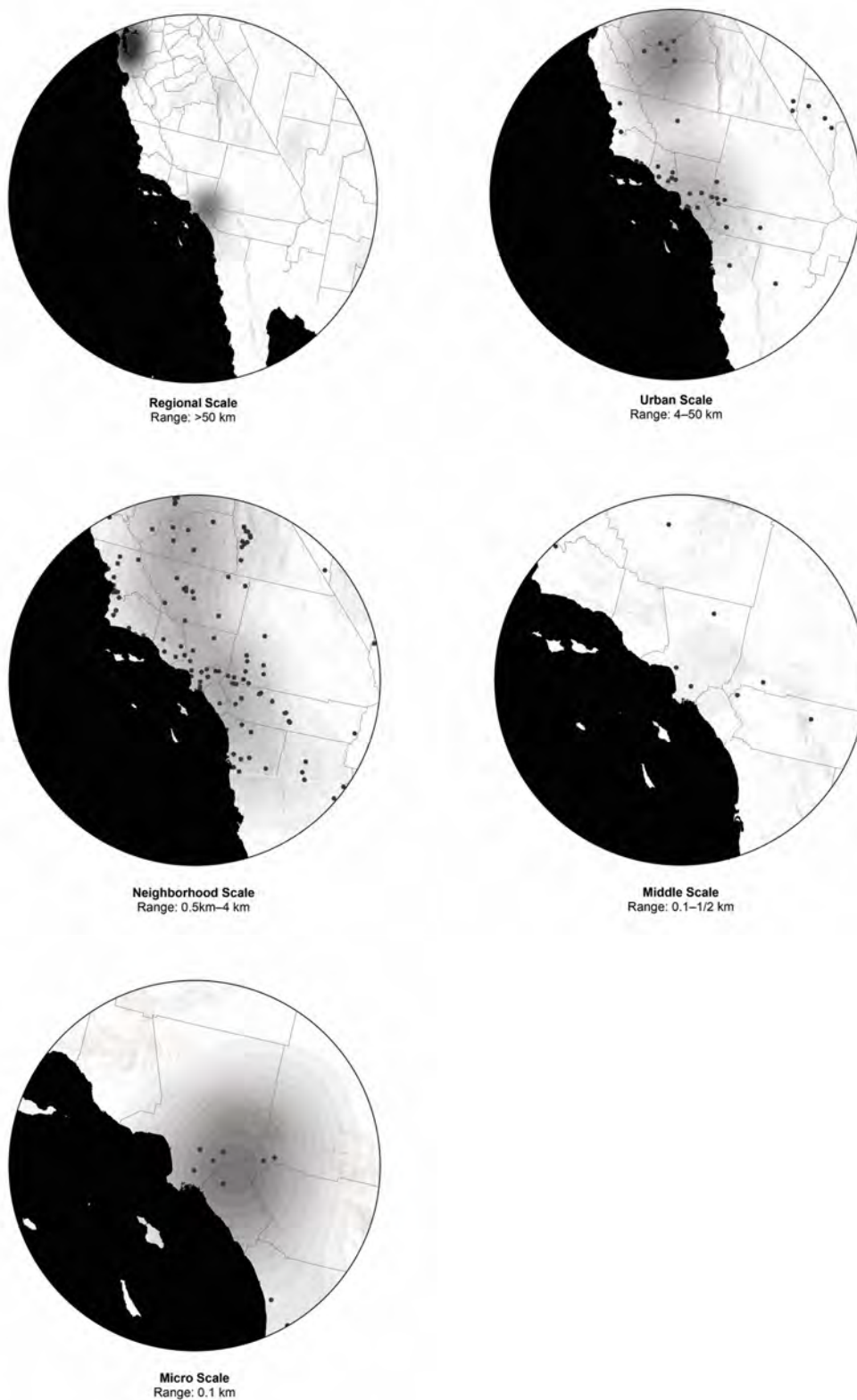

Figure 1: Atmospheric Sensing: Scales and Subjects. Federal protocols correlate the sensor type with the people and places it is meant to cover. Population-oriented studies produce large urban- or regional-scale assessments, while source impact and concentration studies produce finer-grain sensor networks.
Data Source: https://gispub.epa.gov/arcgis/rest/services/OAR_OAQPS/AQSmonitor_sites/MapServer
(Map by POST–Project for Operative Spatial Technologies, 2021)

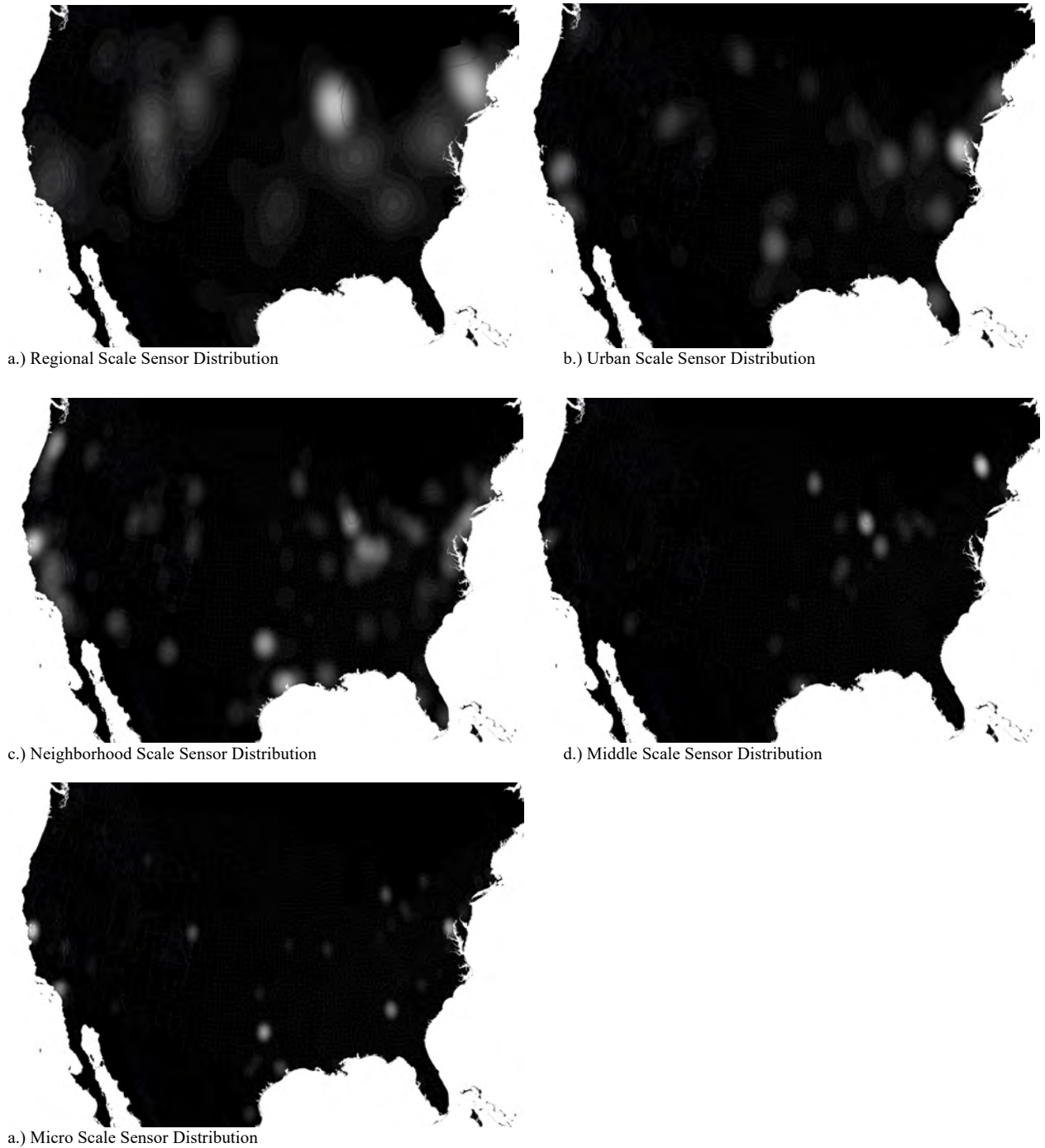

Figure 2: Atmospheric Sensing Heatmaps by Sensor Type. Heatmaps showing concentrations of different sensor types including active sensor locations including: a) regional, b.) urban, c.) neighborhood, d.) middle and e.) micro scale. Dark areas indicate blindspots in environmental monitoring at each scale. Data Source: https://gispub.epa.gov/arcgis/rest/services/OAR_OAQPS/AQSmonitor_sites/MapServer (Map by POST–Project for Operative Spatial Technologies, 2021)



Figure 3: Atmospheric Sensing Heatmap Composite. Composite heatmap showing concentrations of active sensor locations including sensors of all five types. Dark areas suggest blindspots in environmental monitoring.
Data Source: https://gispub.epa.gov/arcgis/rest/services/OAR_OAQPS/AQSmonitor_sites/MapServer
(Map by POST–Project for Operative Spatial Technologies, 2021)

6.0 DISCUSSION

6.1 Indexing Population

Further study correlating the sensor types and locations with the locations and populations of cities in general, and border cities in particular, would prove useful. An index of “sensors per capita” in areas falling under the coverage map of each sensor type would provide insight into the level of assessment each urban area receives.

6.2 Indexing Investment

Further study investigating the investment in new sensors, and disinvestment evidenced by the consolidation or the disactivation of existing sensors would provide insight into the shifting priorities and trends in the provision of environmental air quality monitoring. Additional research in the funding streams and appropriations at federal, state, and local level would also prove instructive in identifying areas that continue to be risk.

6.3 Neighborhood Investigations

While the completed mapping provides an overall assessment and characterization of sensor coverage in the borderland, its quantitative methods can be further refined and its study area narrowed for applications at a smaller scale in the border cities and neighborhoods themselves. Continued investigation will further develop and refine the tools, visualizations, and methods, to identify underserved neighborhoods and communities with urgent needs for improved sensing.

6.4 Binational Collaboration

Currently there are few sensing networks collaborating across the international divide. Collaborative border regions are few and far between, with only five transborder air quality monitoring areas border-wide established in the past decade (see Eades, 2018). Instead, border air quality monitoring is enacted through a collection of state agencies operating mostly independently within their respective boundaries.¹ The most recent binational initiatives include the maintenance of “air-monitoring networks with real-time access to air quality data in all binational airsheds” as a top priority (Eades, 2018), but sustained binational efforts thus far have been few, and binational participation is low.² Previous work by the author(s) has resulted in the installation of temporary low-cost monitoring across the international divide, and more work can be done to make this or similar initiatives more permanent.

CONCLUSION

Need for Improved Representation

In light of the current deficiencies in air quality monitoring evidenced by the maps, the demand for an extensive, actionable accounting of air quality in border regions is greater than ever. As some of the most highly polluted environments overlooked by environmental air quality sensors, transnational airsheds—and populations affected by them—demand new forms of representation.

ACKNOWLEDGEMENTS

Mapping and analysis by POST—Project for Operative Spatial Technologies, a Texas Tech College of Architecture research center. Stephen Mueller, Director of Research; Ersela Kripa, Director of Projects; Karla Padilla and Sofia Dominguez Rojo, Research Assistants.

REFERENCES

- “Ambient Air Quality Surveillance.” *Code of Federal Regulations (CFR)*, title 40. 2021.
- Coronado, Irasema and Stephen Mumme. “Environmental Governance at the U.S.–Mexico Border: Institutions at Risk.” *Binational Commons: Institutional Development and Governance on the U.S.–Mexico Border*. 2020.
- Eades, Lauren. “Air Pollution at the U.S.–Mexico Border: Strengthening the Framework for Bilateral Cooperation.” *Journal of Public and International Affairs*. 2018.
- Environmental Protection Agency (EPA). Air Quality System (AQS) Monitoring Network Resource Server. 2020. https://gispub.epa.gov/arcgis/rest/services/OAR_OAQPS/AQSmonitor_sites/MapServer
- U.S. Environmental Protection Agency. *Border 2012: U.S.–Mexico Environmental Program: State of the Border Regions Indicators Report, 2010*. Border 2012 Indicators. 2011.
- Grineski, Sara E. and Patricia M. Juárez-Carrillo. “Environmental Injustice in the U.S.–Mexico Border Region.” In *Social Justice in the U.S.–Mexico Border Region*. Springer, Dordrecht. 2012.
- Heyman, Josiah. “Environmental Issues at the U.S.–Mexico Border and the Unequal Territorialization of Value. In A. Hornberg, J. McNeill, and J. Martinez-Alier (eds.), *Rethinking Environmental History: World-Systems History and Global Environmental Change*. New York: Altamira Press. 2007.
- Kripa, Ersela and Stephen Mueller. (in-press). “Atmospheric Jurisdictions.” *Airscapes*, Rafael Beneytez-Duran and Javier Garcia-German, eds. Actar.
- Moya, Eva M., Silvia M. Chavez-Baray, and Miriam S. Monroy. “Health Institutions at the U.S.–Mexico Border.” *Binational Commons: Institutional Development and Governance on the U.S.–Mexico Border*. 2020
- Mueller, Stephen and Ersela Kripa. (in-press). “Drawn Across Borders.” *Design for Vulnerable Communities*. Emanuele Giorgi, Tiziano Cattaneo, Alfredo Mauricio Flores Herrera, Virginia del Socorro Aceves Tarango, eds. Springer Nature.
- Pan American Health Organization (PAHO). 2012. *Health in the Americas*. Washington, D.C.
- Southern Border Communities Coalition (SBCC). 2021. *U.S. Border Demographics: Vibrant, Diverse, and Binational*. 2021. Accessed 11 Nov 2021. https://www.southernborder.org/border_lens_southern_border_region_at_a_glance
- U.S. Department of Health and Human Services (DHHS). 2017. *The U.S.–Mexico Border Region*. Accessed 11 Nov 2021. <https://www.hhs.gov/about/agencies/oga/about-oga/what-we-do/international-relations-division/americas/border-health-commission/us-mexico-border-region/index.html>

ENDNOTES

¹ Combination of TCEQ, NM Environment Department, Arizona Department of Environmental Quality, The California Air Resources Board, the Imperial County Air Pollution Control District, and the San Diego County Air Pollution Control District. (see Eades, 2018)

² In a comprehensive EPA report on binational air quality, only five stations (San Diego, Imperial Valley, Nogales, Ciudad Juarez/EI Paso, Lower Rio Grande Valley) contributed data. Only the Ciudad Juarez/EI Paso system included sensors on the MX side, due to “quality assurance issues” with Mexican monitoring systems and the “complexity of maintaining a binational network.” (See EPA, 2011)

Connect or Adapt: Analytic Framework for the Planning and Design of Resilient Spatial Networks

Daniel Kin Heng Wong¹, Wei Chien Benny Chin¹, Roland Bouffanais², Thomas Schroeffer¹

¹Singapore University of Technology and Design, Singapore

²University of Ottawa, Ontario, Canada

ABSTRACT: A high level of connectivity is one of the key objectives in the planning and design of many urban developments. However, during an epidemic event, a frequent practice to control the spread of the disease is to control the access, e.g., through measures of safe distancing (social distancing) or zone isolation (lockdown). These measures conflict with the objective to increase the connectivity of spaces, i.e., the increment of connectivity would also increase the possible movement of people between places and thus increase the risk of disease spreading. Therefore, the evaluation of the development layout and the resilience of its spatial network with the consideration of both connectivity and separation becomes an important task. To understand how the connectivity of spaces affects the spread of a disease, this paper proposes an analytic framework based on the spatial mapping of human movement at the urban and architectural scale. This approach allows for the evaluation of the effects of isolating spatial nodes on the disease spreading process in a spatial network. Our paper explores how the connectivity of nodes affects people flow and identifies the morphological and typological features of a spatial layout that relates to that connectivity. Next, it evaluates the dynamic effects of altering the network structure on movement and clustering of people through a series of link removal analyses. Our findings suggest that for the scale of our case study, a compact university campus in Singapore, complete zone-separation or isolation measures may not be necessary. Instead, breaking the high edge-betweenness links can increase the spatial separation while reduce physical interactions and close contacts by forcing people to take less frequented route detours. By framing the spaces of such a built environment as a complex adaptive system, the results provide important insights into human-centered design and interventions for public health at the building and urban scale.

KEYWORDS: Spatial connectivity, lockdown, disease control, post-pandemic, COVID-19

1 INTRODUCTION

1.1 Background

Increasing connectivity is one of the key objectives of many urban developments, because the accessibility and efficiency of space use improves as the connectivity between spaces increases (Cervero 2004; Gopalakrishnan et al. 2021). Previous studies indicated that strong spatial connectivity could attract higher traffic and more visits of people (Jiang 2009; Chin and Wen 2015). Increasing connectivity does not only improve the accessibility between spaces but also has significant effects on fostering social integration, which can contribute to more cohesive communities (Eom and Cho 2015). Previous studies suggested that a connected space can increase walkability and thus have a positive effect on health (Eom and Cho 2015). Vibrant and accessible urban form was also found to generate a better community in terms of social cohesion (Mouratidis and Poortinga 2020).

However, during an epidemic event, a common and effective practice to control the disease is social distancing. This is because the spread of a person-to-person infectious disease happens when two persons interact physically in a space. In the case of COVID-19, the virus is transmitted through droplets (Wu et al. 2020) and spread through the air or aerosols (Galbadage et al. 2020), meaning that a sufficient physical distance between people can protect the susceptible person. Therefore, various levels of distancing measures—from the collective to the individual level—have been implemented widely during the COVID-19 epidemic. At the large scale, borders were closed to reduce the interactions between countries, states and cities (Dickens et al. 2020; Koh 2020). At the individual scale, people have been working from home whenever possible. They also have been distancing themselves from each other while leaving their home for essential activities, including shopping, and traveling on public transportation (Williams 2020). In other words, the concept behind these zone isolation and social distancing measures has been to reduce the connection between spaces and people.

These disease control measures counter the objective to increase the connectivity of spaces, i.e., the increment of connectivity also increases the possible movement of people between places and thus increase the risk of disease

spreading. As such, the evaluation of the architectural layout and the resilience of a spatial network with the consideration of both connectivity and separation becomes a critical issue. To understand how the connectivity of spaces affects the spread of disease, this paper proposes a framework to analyze the human movement process in the architectural-urban scale against the features of its spatial design, and to evaluate the possible effects of space isolation to the spreading process in a spatial network. This study combines structural analysis, which focuses on network and spatial configurations, with circulation analysis which analyzes the movement of people through the network (Boeing et al. 2021). Network vulnerability is a commonly discussed issue in complex network analysis on connectivity, e.g., power grid networks (Bompard et al. 2010; Wang et al. 2011), cargo shipping networks (Ducruet et al. 2010; Viljoen and Jourbert 2016), and human movement networks (Wen and Chin 2015; Morelli and Cunha 2021). Based on a network vulnerability measurement, Wen and Chin (2015) developed a framework to analyze a building-to-building network within a campus to identify the vulnerable links, i.e., the links that if removed, would increase the separation within the network, and propose a way to generate the isolation zones by removing those links during a disease outbreak.

1.2 Research design

Using the Singapore University of Technology and Design (SUTD) Campus as a case study, our paper explores how the connectivity of nodes affects people flow and identifies the morphological and typological features of a spatial design that relate to that connectivity. Our study evaluates the dynamic effects of altering the network structure on movement and clustering of people through a series of scenario analyses. From the point of view of complex network studies, we can assume that people tend to take the shortest path to move from one node to another, and this shortest path could shape the spatial distribution of the intensity of human movement to a significant level, through the emerging pattern in the spatial network (Jiang 2009; Chin and Wen 2015). Adding barriers to block the connections---spatial zoning---is a strategy to generate and increase the separation of places. In other words, adding barriers forces people to take an alternative path and thus increases the separation of people. In our study, we intended to test how the zoning of places could improve the separation of spaces and to what degree the accompanying effects in terms of spatial distancing could be maximized. By framing the spaces of a built environment as a complex adaptive system, the results provide important insights into human-centered design and interventions for public health at the urban and building scale. Especially in the event of a pandemic like COVID-19, it is salient for planners and designers to consider an evidence-based public health process as routinely as that of sustainability, with planning principles and design elements at varying scales guided by empirical data (Azzopardi-Muscat et al., 2020).

2 MATERIALS AND METHODS

2.1 SUTD Campus and network dataset

SUTD is one of six autonomous universities in Singapore. Its permanent campus opened in 2015. The academic buildings of the campus cover an area of approximately 83,000 m² and are currently composed of four interconnected buildings --- 1, 2, 3, and 5, with 4 slated for future development (see Figure 1). The spatial organization of the campus adopted two main concepts, 'Circulation' and 'Interaction' (Schroepfer 2017) --- with horizontal, vertical, and diagonal flows connecting the spaces of the four buildings. UNStudio --- the architectural firm behind the SUTD project --- conceptually designated two main axes of circulation, the 'Learning Spine' and the 'Living Spine' which intersect at a central interaction zone --- the Campus Centre. Several interaction zones also serve as connective point, i.e., skybridge connections between Buildings 1 and 2 and 5, vertical staircases at the corners of buildings, circular staircases at the Campus Centre and a garden leading up to the Level 3 Sky Garden. An efficiency of circulation and multiple zones of interaction define the user experience on the campus.

In our study, we extracted node points from the main program areas and defined edges by connecting each node point to other program areas which are spatially accessible via doorways and corridors. We assigned the Euclidean distance between the nodes to their corresponding edges as is the case for spatial networks. We also consolidated adjacent elevator cores and stair lobbies as a single node and connected them directly and to all other vertically adjacent lobby nodes, considering elevator and stair cores as 'vertical streets' with lobbies on each floor as node points.

2.2 Analysis framework

Our study of SUTD was organized in three major steps: (1) a set of visualization of the network centrality measures in 3-dimensional physical space, for an overview understanding on the connectivity of spaces using quantification metrics from complex networks; (2) an experiment of continuously removing high betweenness edges to increase separation of nodes were performed and the corresponding outcomes of the edge removals were also presented; (3) the current intensity of activity in the main connection nodes of the campus was recorded, presented and discussed.

In the first step, we used the following three centralities (degree, closeness, and betweenness centrality) for measuring the connectivity of nodes (Freeman 1978; Barrat et al. 2004). Degree centrality shows the number of connected links for each node. Closeness centrality measures the distance (in steps) from a node to the rest of the network. Betweenness centrality captures the critical level of a node in terms of being the connection between communities. The three centralities are the simplest yet useful measurements in complex network analysis for the measurement of important levels of nodes within the network.

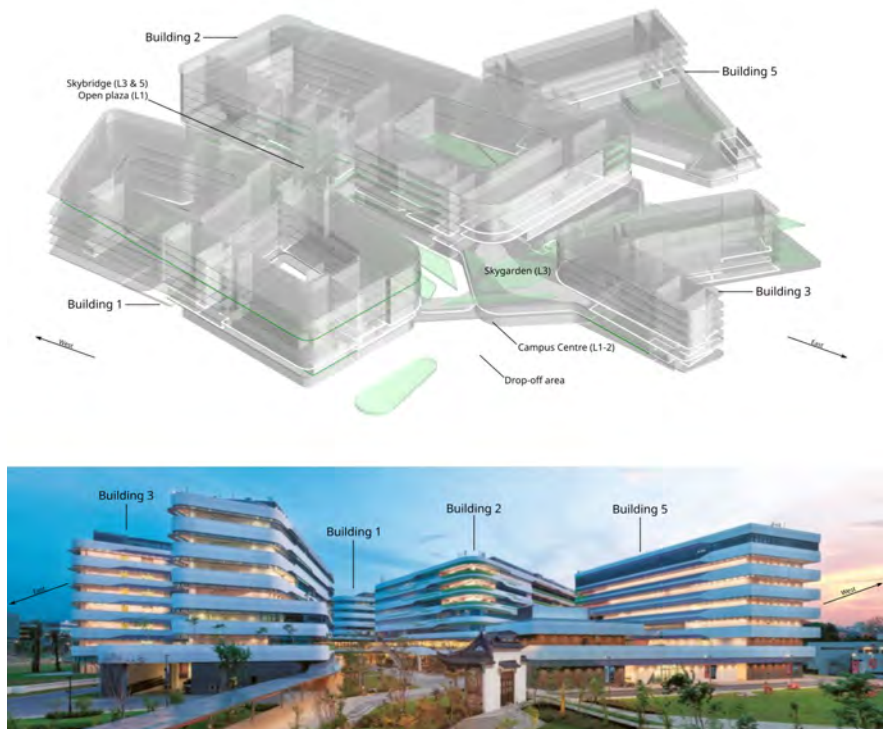

Figure 1: SUTD Campus buildings: (top) 3D model of the four buildings and connections between buildings and (bottom) the photo of the case study buildings from the northeast exterior. Source: (Photograph by Daniel Swee)

The second step in our study was an experiment to assess the effect of edge removal to the separation degree of the spaces. The procedures include three phases: (1) identify of high betweenness edges, (2) remove the top ranked edges iteratively, and (3) calculate the effects of the removal. For the first step, edge-betweenness index --- a variant of betweenness centrality for edges (Girvan and Newman 2002) --- was used because the removal of edges with high values of this index would have strong impact on separating the network structure into zones (Wen and Chin 2015). In the second phase, the edges were ranked in descending order and the edges with the top 50 edge-betweenness indexes were removed iteratively. During each removal, two node-level indexes were calculated for the evaluation of the effects: closeness centrality and PageRank.

Closeness centrality measures the 'closeness' of a node to the rest of the network---i.e., the reciprocal of the average shortest path lengths from one node to all other nodes. This means that closeness centrality can capture the opposite of the 'separation' level (Freeman 1978; Wen and Chin 2015). By removing the links, the intention is to increase the separation of nodes and to create the zoning effects within the network. Therefore, the removal of links increases the separation level and decreases the closeness. In other words, by monitoring the reducing trend of closeness, the effectiveness of the links removal can be evaluated. Since the removal of links potentially splits the network into disconnected components, we used the Wasserman and Faust improved version of closeness (Wasserman and Faust 1994) through the Python NetworkX package, which takes the multiple components of a network structure into account. The average closeness centrality was used to evaluate the overall separation level of the network in each of the iterations.

PageRank is a metric for measuring the proportion of people (originally simulating random internet surfers) visiting each node after entering an equilibrium state (Brin and Page 1998). In our study, we intended to understand how people move when the network structure changed---some links were removed. To this end, PageRank is a suitable measurement for capturing the proportion of people who would visit each node. We calculated the Shannon Evenness Index based on the PageRank scores to evaluate the level of evenness of the distribution of nodes' proportion of people. The measurement of evenness is to evaluate how people would move and be spatially distributed with some spatial links removed. In theory, when critical paths (typically the most connected and convenient paths) are blocked, people use alternative paths and thus the proportion of people is divided and split into different nodes. Hence, the increment of evenness of the system. Here, we intended to explore how that evenness would change and to what level the removal of links could increase the evenness of the distribution of people.

In the third step, we collected the movement data via people counters to explore empirically the human movement patterns within the campus (Wong et al. 2021). We installed several SensMax Outdoor People Counters at the entrance/exit points of five nodes: (1) the Level 1 Campus Centre, (2) Level 3 Sky Garden, (3) Level 1 Open Plaza, (4)

Level 3 Skybridge and (5) the Level 5 Skybridge (see Figure 1 for locations). Buildings 2 and 3 are connected at Level 1 and 3 through the first two nodes (Campus Centre and Sky Garden). The Level 3 Sky Garden node is also linked to Building 1 through a skybridge. Buildings 1 and 2 are connected at the middle part of both buildings through the next three nodes (Open Plaza and two skybridges) at Levels 1, 3, and 5. The data were recorded over seven weeks and aggregated by hours for analysis. The variations in space use volume over various times of the day and different days of the week were analyzed for potential patterns in space use. The data collected was completely anonymous, thus respecting the privacy of the user.

3 RESULTS

3.1 Spatial network connectivity

Figure 2 shows the spatial distribution of the three node centralities measurements. The high degree centrality nodes are located at the lift lobbies, i.e., the vertical circulation nodes (Figure 2(a)). The major lift lobbies showed the highest values, whereas the peripheral corner of each floor showed lower degree values. This indicates that the lifts have more connections than the other types of places. For closeness centrality (Figure 2(b)), the middle part of Building 2 becomes the core region with the lift lobbies being the centre of this core. The lift lobbies of Building 2 located in the Campus Centre and the lift lobbies in the central part of Building 1 are the secondary core area of closeness centrality. This indicated that these spaces can easily connect to the rest of the campus. The spatial distribution of both degree and closeness centralities were similar between floors, i.e., similar horizontal pattern was found on all the floors. However, the betweenness centrality measures showed a different pattern between floors. The high betweenness centrality nodes appeared only on certain floors, e.g., the Level 3 entrance from the sky garden to Building 2 and the two skybridges between Buildings 1 and 2. This indicated the places that were bridging distinct groups of spatial nodes in the campus. On the other hand, the peripheral corners showed the lowest betweenness centrality. To understand the strongly connected node community, a community detection algorithm (Louvain modularity algorithm) was run with the network data. In Figure 3, the nodes in the same colours indicated the community---strongly inter-connected nodes. Overall, these network metrics provided an understanding of the spatial connectivity structure of the SUTD Campus.

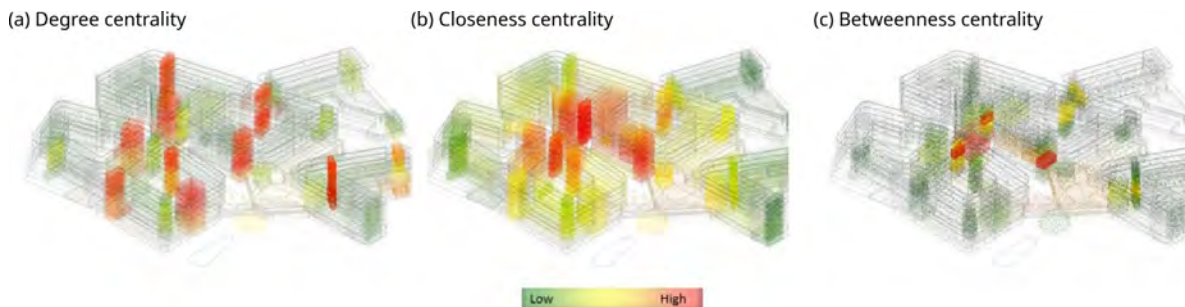

Figure 2: The three network centrality measures in 3D: (a) degree centrality, (b) closeness centrality, and (c) betweenness centrality.

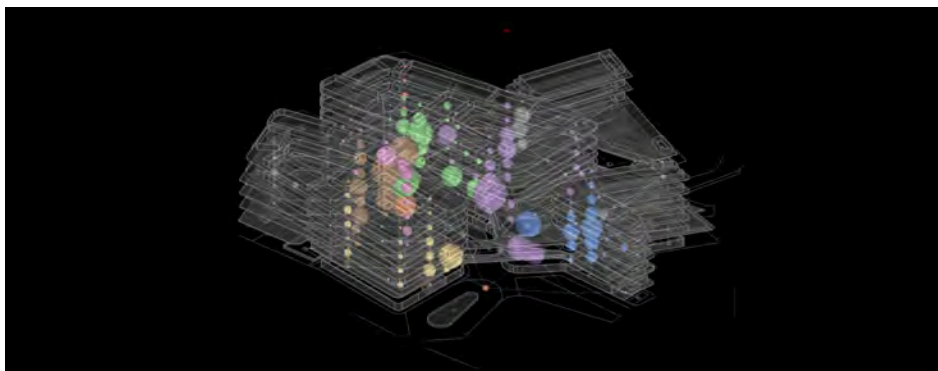

Figure 3: The node community results detected using Louvain modularity algorithm, presented in 3D building layout.

3.2 Zoning the campus by the removal of high edge-betweenness links

The following paragraphs discuss our experiment of links removal. We targeted the links with the highest edge-betweenness because these links were the most critical connections of the network in terms of connecting various parts of it, i.e., different communities. The high edge-betweenness links were also known as the 'bridges' or 'shortcuts' because these links were usually connecting the 'long-step-distance' nodes. Thus, these nodes usually suggest a larger traffic of human movements. Figure 4 visualizes the nodes grouped into different communities using the Louvain

modularity algorithm. The nodes are labelled with the building numbers (1, 2, 3, and 5). The node positions were calculated using the spring layout algorithm (an algorithm for assigning nodes and edges positions based on network structure). A total of nine communities were identified. It is interesting to show that the Buildings 1 and 2 were split into three communities each. In other words, the spatial connectivity network structure was more complex than the building space layout structure.

The top 50 edge-betweenness links were coloured and labelled in Figure 4. The top ten links (red) are the long 'bridges' that connect nodes located at various spatial locations and communities. Some nodes were linked with more of these bridges, e.g., the Campus Centre at both, Levels 1 and 2, and the drop-off area (Building 1, Level 1). Thus, the removal of the top 50 links would isolate these nodes. Two high edge-betweenness links were important: No. 5 - Level 2 skybridge and No. 6 - Level 1 open plaza. The Level 2 skybridge connects the Campus Centre (Building 2) with the library (Building 1) whereas the open plaza connects the study area at Level 1 for these two buildings. To disable these links, some form of spatial barrier would need to be put in place, or access to the spaces (e.g., corridors/rooms) would need to be limited.

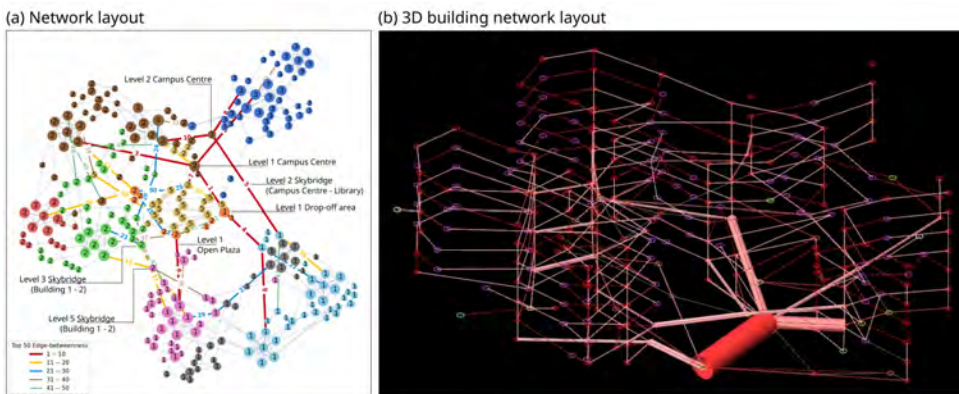

Figure 4: The campus network in (a) network layout and (b) 3D building model layout. In (a), the nodes were labeled by the building numbers, colored by a community detection method (Louvain modularity algorithm), and sized by the PageRank scores. The edges were ranked from 1st to 50th by edge-betweenness.

Figure 5 shows the changes of average closeness and the PageRank evenness in the process of iteratively removing the top 50 links. The trend of average closeness was a decreasing trend, which was expected and reasonable because the removal of links would increase the separation within the network---more steps were needed to reach the other nodes overall, hence the reciprocal of the average shortest path length would decrease. The blue dashed vertical line (removal of the top 6 links) indicated the first significant decrease---a drop from 0.16 to 0.14---and decrease less significantly afterward. This is because the removal of the top 6 links would split the Buildings 1 and 2 at the ground floor, leaving only the higher floors skybridges connected. Most of the spaces would then be separated and the people would need to take a longer detour to access the other building (if necessary). While most people work/study only at their offices or classes in one building, the interaction between buildings could then be reduced and controlled by only closing 6 of the links.

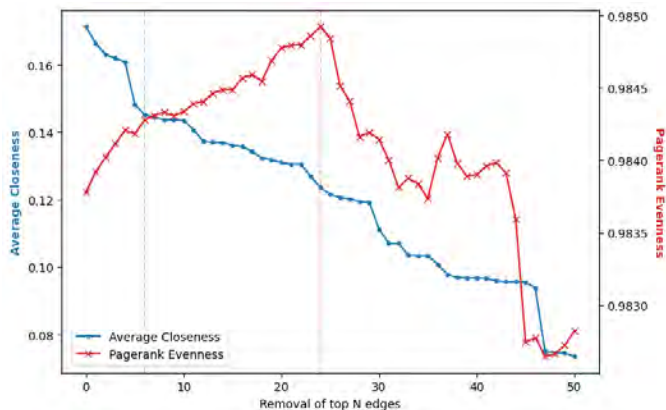

Figure 5: The changes of average closeness (in blue, left vertical axis) and PageRank evenness (in red, right vertical axis) by the removal of the links with the top 50 edge-betweenness. The first data points indicate the original campus network (no removal).

On the other hand, the evenness of PageRank increases from the initial of the removal process until the top 24 links were removed. The increment trend was expected and reasonable because when the top betweenness links were removed, the separation increased, and people would take detours---this forces the traffic flow of people towards other nodes. However, while a lot of links were removed, some links became more critical in terms of connecting spaces, i.e., the new bridges which absorb a large traffic in the movement process. In our case study, the evenness of PageRank reached a peak value at top 24 links (Figure 5, red dashed vertical line). This means that the removal of the 25th highest edge-betweenness link would start to generate the new 'bridges' that attract the flows. A significant decrease occurs from top 24 to top 32, where evenness values were similar to the initial evenness value.

3.3 Intensity of human activity in major connection nodes during the COVID-19 pandemic

Figure 6(a) shows the daily total number of people passing by five major connective nodes that were located at two central 'interaction' zones, on different floors: the Campus Centre at Level 1 and above it, the Sky Garden at Level 3; and the open plaza (Level 1) at the middle section between Buildings 1 and 2, with the 2 sky bridges above it at Level 3 and level 5. The traffic at the ground level (both Level 1 Campus Centre and open plaza) were significantly larger than the upper levels. The Level 3 Skybridge (connecting Buildings 1 and 2) had more flow than the Level 5 Skybridge. This means that during the data collection period, the spaces on the lower floors were more occupied than those on the higher floor. This is reasonable because users would not go to a higher floor if their offices/classrooms were located at lower floors. Our study also showed the differences of the magnitude of the differences of space use between lower and higher floors. Because the Level 3 Sky Garden is not sheltered, the usage of this node was a lot lower than that of the Ground Floor, which also serves as a connection from the dormitories/Building 5 to the front entrance (drop-off point) of the campus and Building 1. The open plaza between the study area of Buildings 1 and 2 is open to the public and building management control measures are not applied in this location. In contrast, the Levels 3 and 5 skybridges can only be accessed within the building---only students, staff or visitors who 'check in' the Campus can enter the building. This Level 1 plaza is also a major access point to the neighbouring Buildings 1 and 2 study areas. It is well-used by students both on weekdays and weekends. These are some of the reasons explain the higher space use in the Level 1 open plaza compared to the skybridges.

Figure 6(b) shows the location-based normalization of the flow of people---the proportion of counts by day at each location. Four lines (except that of the Level 1 open plaza) show similar patterns---a slight increase from Monday to Wednesday or Thursday, then a decrease on Friday and drop to a lower level on weekends. The space use of the open plaza was more stable than that of the other four locations---the proportion of use was similar from Monday to Saturday, with a slight decrease on Sunday. The reason for this may be that the node is public and not spatially constrained.

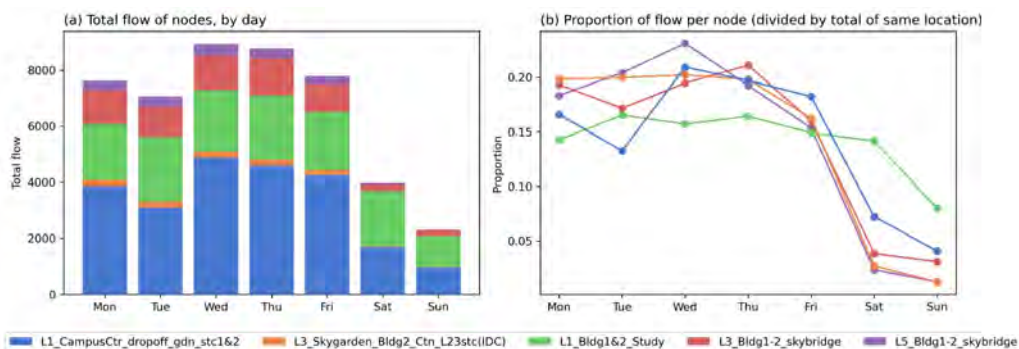

Figure 6: The number of people moving through the five nodes by day of the week: (a) The total flows by day, (b) the proportion of flow per node (divided by the total number of people at the same node).

Figure 6 shows the Level 1 Campus Centre node which had the highest level of human traffic. This finding, combined with those of the network analysis (Figure 4) demonstrates that this node has the top 3 linkages of highest edge betweenness. During the initial response to COVID-19, the SUTD building management access policy mandated compulsory registration for all persons entering the campus buildings at this single Campus Centre node. It was a practical solution for capturing access records of all visitors before they circulated to the higher levels and other spaces in buildings 1,2,3 and 5. However, the centralizing of all building access circulation to a single node rendered the Level 1 campus centre a highly vulnerable node in the entire network during that period. However, an additional registration and access point was subsequently implemented at Level 1 Building 2 study area lift lobby, providing an additional pathway in the network, reducing the human traffic loading on the Level 1 Campus Centre node, and thus reducing its potential as a point of spread and contagion. To this end, increasing the numbers of access pathways whilst assuming the practicality of building access management, is beneficial for the resilience of the circulation network as a whole.

4.0 DISCUSSION AND CONCLUSION

4.1 Spatial network analysis framework and planning and design for resilience

During a pandemic or epidemic situation like COVID-19, one key measure to control it is to split the crowd (e.g., social distancing or safe distancing, work-from-home and split teams for workplaces management measures, and cross-region or cross-border movement restriction) to reduce the chances of spreading the infectious disease. In our study that is based on the emergence of a complex network, we simulated spatial network modifications and analysed links removal in a small university campus. Our findings suggest that for the scale of such an environment, complete zone-separation or isolation measures may not be necessary. Instead, breaking the high edge-betweenness links could increase the spatial separation and reduce physical interactions or close contacts by forcing people to take less frequented detours. Limited entry points concentrate the flow of people in a few locations and therefore maximize exposure to potential virus-carriers. Multiple entry points even out circulation flow and reduce the risk of exposure. They provide alternative circulation routes for users to reach their destinations. From the spatial network point of view, resilience in the system is reinforced with multiple pathways as backup in the case of one pathway being closed.

In our study, the Campus Centre was connected to several high edge-betweenness links. From the view of complex network, to increase the separation between the campus buildings, this node should be closed or its access highly restricted. However, in our case, because of cost, manpower requirement and operational effectiveness, the Campus Centre was used as the main access point---a centralized control measure was set up for the whole university. This set-up forced all users to transit through the Campus Centre---and increased the probability of physical interaction (or close contact) and the traffic at the nearby lift lobbies. In other words, this is not a preferred situation from the view of complex network analysis.

The SUTD Campus was originally designed with multiple entrances, including staircases, escalators and lifts going up to each of its buildings. In addition to the large main Centre next to the drop-off area, the Campus has many other access points. This potentially allows for zone separation between the buildings and as such presents a good example of resilient spatial design. However, there are several weak points in the spatial layout of SUTD---e.g., the canteen is a central unavoidable point of interaction. Time-based shift policies between buildings may be a solution for this problem. Also, access to the higher levels in Building 3 is via a main elevator core and an open staircase. During the COVID-19 pandemic, all the vertical connections from the ground level to buildings other than through the Campus Centre were closed. Access was limited to one controlled location for all the buildings, with contact-tracing registration implemented (this was also the case in many public and restricted access buildings in Singapore, due to manpower and operational access control requirements).

In terms of scale, the SUTD Campus consists of four buildings, which is a common size for a cluster of public space. This urban morphology of several buildings that form a spatially connected environment for public activity is also seen in various public typologies in Singapore. For instance, public transport interchanges with shopping malls (e.g., Tampines Interchange and Jurong East Interchange) or community centres with integrated sport facilities, restaurants, or retail shops (e.g., Kampung Admiralty and Our Tampines Hub). Therefore, a similar analysis framework could be applied to these other types of public spaces at a similar scale for the identification of critical links that could be removed, and for the evaluation of their effectiveness in case of setting up disease control measures.

4.2 Strategies for urban and architectural creative design process

How do we align the spatial design strategy of a campus or urban-architectural space designed to maximize points of interactions in circulatory systems, yet with the goal of disease-control? This analysis has shown that for an adaptive resilient spatial system, it is important for the network analysis framework to take place at an early stage to identify network effects of circulation system, while designing connections between spaces.

Firstly, during the initial conceptual design brief stage, a hierarchy of programme spaces is made based on their size, number of levels, type of connections, ingress and egress points, etc, with their required relational proximities listed. Their relationship to each other is then linked in an initial conceptual spatial layout. This can be done concurrently or preceding the interfacing to existing site programmes, e.g., links such as walkways, bus stops, gardens, other buildings, natural landscape elements and geographical conditions. At this point, one can input these relationships and parameters into a spatial network and identify the links with highest network connectivity---which, when removed, can isolate zones while keeping the spatial network resilient. This means to intentionally plan and design for the flexibility of adapting spatial thresholds by closing off major singular connections between buildings or functional zones while maximizing and retaining multiple alternative linkways, resulting in an evenly distributed flow of people traffic. Thus, designing for continuity of the urban function and experience is facilitated. Additionally, the actual width of these alternate linkways and access points could also be sized by design to accommodate increased flows, and in the context

of COVID-19 pandemic, facilitate safe distancing. Next, the layout can be modified by adopting a polycentric or distributed approach to the layout of its spaces, connections, and access points. This further contributes to the resilience of the entire system. Major spatial links of the system can be reduced or separated, whilst multiple clusters that form a system of related functional spaces continue to be accessible, e.g., a cluster of classrooms, faculty offices, cafeteria, vertical access systems, multiple drop-offs, and entrances.

Iterations of multiple variations of this design layout can then be made and improved. One computational approach would be to employ an evolutionary design which scores the overall layout as well as its nodes and linkages by network measure parameters, e.g., network resilience to opening and closing of global and local network links, heterogeneity of connective locations, flexibility of programme repurposing, extent of programme space distribution and redundancies etc. Low scoring local and global nodes and linkages could be identified, adapted or replaced and the results iterated over many generations to evolve and optimize a variety of outcomes for further development and detailing. This design approach would be the subject of a future research paper.

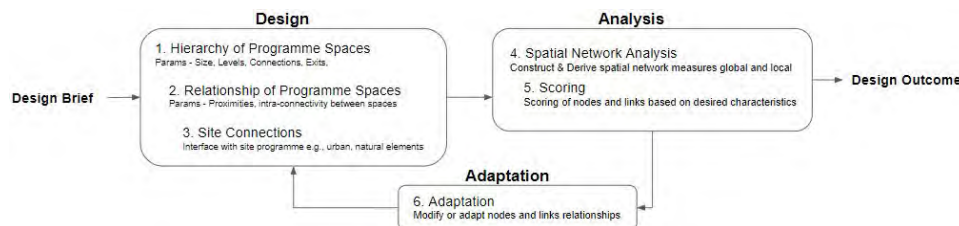

Figure 7: Flowchart of Iterative design process for resilient spatial network.

In existing buildings, time-based spatial zoning strategies can be used without extensive modifications to spatial conditions. When spatial flexibility is not a given, time shift-based policies which buffer and even out people traffic in specific spatial zones could be used. Alternate access control measures or technologies which do not depend on singular point of access could be explored. E.g., people counters or cameras with optical flow techniques can monitor the people traffic at each space; indoor localization (Bluetooth and Wi-Fi) can also help to identify and trace the proximity between groups of people.

4.3 Conclusion

In this paper, we proposed a framework for spatial design and analysis that adapts for resilience in disease control situations. The framework studies the built environment, its spatial network generated from spatial nodes and their links in the design of the urban-architectural environment and examines the layout for major linkages, spatial community clusters and the effect of the reduction of network percolation by link removal. By relating these findings back to the spatial design and building management zoning policies in the case of an existing campus, we discussed and examined its spatial design, access control, and the location and distribution of functional spaces. We looked at external to internal movement, internal circulation, and adequate spacing for multiple minor pathways within a development at the urban-architectural scale. We examined the actual spatial usage of a case study and its key node points. In short, the analytic framework proposed in this paper and the findings of our study suggest an adaptive approach to planning and design that would result in a more resilient built environment.

Analytics help to forecast and optimize urban infrastructural design development and decisions, but they are only as good as their input data and model specifications (Boeing et al. 2021). (1) Our network was generated based on the spatial organization of the SUTD Campus. Its connections to the urban context were not considered, e.g., the entrances from the adjacent public transportation stations, the pedestrian entrances, the vehicle entrance points, the campus parking lots, and the hostel entrance points. By excluding these, some of the nodes' importance levels could be underestimated, especially for those located at the ground floor, due to edge effects. (2) The architectural information of the nodes and links was simplified for the purpose of this study. The details including the areas of classrooms, offices, facilities, etc., and the lengths of the corridors, were not considered in the model calculation, and could be incorporated in future for further precision. (3) The data collection using the people counters was conducted in January 2021--- during the Phase-2 recovery period from the COVID-19 lockdown (the 'Circuit Breaker') in Singapore. Therefore, the overall movement traffic was lower than pre-COVID-19. We believe it would be interesting to continue monitoring the movement patterns during the current 'new normal' and the future 'post-COVID' periods to check if the pattern remains similar to our findings.

ACKNOWLEDGEMENTS

This research is supported by a SUTD grant (Cities: PIE-SGP-CTRS-1803).

REFERENCES

- Azzopardi-Muscat, N., Brambilla, A., Caracci, F. and Capolongo, S. 2020. "Synergies in Design and Health. The role of architects and urban health planners in tackling key contemporary public health challenges." *Acta biomedica*, 91(3-S): 9-20.
- Barrat, A., Barthelemy, M., Pastor-Satorras, R. and Vespignani, A. 2004. "The architecture of complex weighted networks." *Proceedings of the National Academy of Sciences*, 101(11): 3747-3752.
- Boeing, G., Batty, M., Jiang, S. and Schweitzer, L. 2021. "Urban Analytics: History, Trajectory, and Critique." SSRN, 3846508.
- Bompard, E., Wu, D. and Xue, F. 2010. "The concept of betweenness in the analysis of power grid vulnerability." *Complexity in Engineering*, February 22-24, 2010, Rome, Italy.
- Brin, S. and Page, L. 1998. "The anatomy of a large-scale hypertextual web search engine." *Computer Networks and ISDN Systems*, 30(1-7): 107-117.
- Cervero, R. 2004. "Transit-oriented development in the United States: Experiences, challenges, and prospects." *Transportation Research Board*, Report 102.
- Chin, W. C. B. and Wen, T. H. 2015. "Geographically modified PageRank algorithms: Identifying the spatial concentration of human movement in a geospatial network." *PLOS ONE*, 10(10): e0139509.
- Dickens, B. L., Koo, J. R., Lim, J. T., Park, M., Quayle, S., Sun, H., Sun, Y., Pung, R., Wilder-Smith, A., Chai, L. Y. A., Lee, V. J. and Cook, A. R. 2020. "Modelling lockdown and exit strategies for COVID-19 in Singapore." *The Lancet Regional Health-Western Pacific*, 1: 100004.
- Ducruet, C., Lee, S. W. and Ng, A. K. 2010. "Centrality and vulnerability in liner shipping networks: Revisiting the Northeast Asian port hierarchy." *Maritime Policy & Management*, 37(1): 17-36.
- Eom, H. J. and Cho, G. H. 2015. "Exploring thresholds of built environment characteristics for walkable communities: Empirical evidence from the Seoul Metropolitan area." *Transportation Research Part D: Transport and Environment*, 40: 76-86.
- Freeman, L. C. 1978. "Centrality in social networks conceptual clarification." *Social Networks*, 1(3): 215-239.
- Galbadage, T., Peterson, B. M. and Gunasekera, R. S. 2020. "Does COVID-19 spread through droplets alone?" *Frontiers in Public Health*, 8: 163.
- Girvan, M. and Newman, M. E. 2002. "Community structure in social and biological networks." *Proceedings of the National Academy of Sciences*, 99(12): 7821-7826.
- Gopalakrishnan S., Wong, D., Manivannan, A., Bouffanais, R. and Schroepfer, T. 2021. "User-driven evaluation of emergent patterns of space use in vertically integrated urban environments." *Architectural Research Centers Consortium 2021 International Conference*, April 7-10, 2021, Virtual/Tucson.
- Jiang, B. 2009. "Ranking spaces for predicting human movement in an urban environment." *International Journal of Geographical Information Science*, 23(7): 823-837.
- Koh, D. 2020. "COVID-19 lockdowns throughout the world." *Occupational Medicine*, 70(5): 322-322.
- Morelli, A. B. and Cunha, A. L. 2021. "Measuring urban road network vulnerability to extreme events: An application for urban floods." *Transportation Research Part D: Transport and Environment*, 93: 102770.
- Mouratidis, K. and Poortinga, W. 2020. "Built environment, urban vitality and social cohesion: Do vibrant neighborhoods foster strong communities?" *Landscape and Urban Planning*, 204: 103951.
- Schroepfer, T. 2017. "Singapore University of Technology and Design: Crossing Disciplines by Design." *Singapore Architect*, 287: 76-86
- Viljoen, N. M. and Joubert, J. W. 2016. "The vulnerability of the global container shipping network to targeted link disruption." *Physica A: Statistical Mechanics and its Applications*, 462: 396-409.
- Wang, K., Zhang, B. H., Zhang, Z., Yin, X. G. and Wang, B. 2011. "An electrical betweenness approach for vulnerability assessment of power grids considering the capacity of generators and load." *Physica A: Statistical Mechanics and its Applications*, 390(23-24): 4692-4701.
- Wasserman, S. and Faust, K. 1994. *Social network analysis: Methods and applications*. Cambridge: Cambridge University Press.
- Wen, T.-H. and Chin, W. C. B. 2015. "Incorporation of spatial interactions in location networks to identify critical geo-referenced routes for assessing disease control measures on a large-scale campus." *International Journal of Environmental Research and Public Health*, 12(4): 4170-4184.
- Williams, N. 2020. "Social distancing in the covid-19 pandemic." *Occupational Medicine*, 70(5): 305-305.
- Wong, D., Gopalakrishnan S., Manivannan, A., Chin, W. C. B., Srikanth A., Hablani C., Bouffanais R., Schroepfer, T. Unpublished manuscript, October 2021. "Complexity Science-Based and AI-Aided Analysis of High-Density Urban Built Environments."
- Wu, Y. C., Chen, C. S. and Chan, Y. J. 2020. "The outbreak of COVID-19: An overview." *Journal of the Chinese Medical Association*, 83(3): 217.

MODE_Bios: A Bioclimatic, Adaptive, Urban Design Tool

Polyxeni Mantzou¹, Anastasios Floros¹

¹Democritus University of Thrace, Xanthi, GREECE

ABSTRACT: Contemporary city planning and urban living policies reflect the urgency of coping with past practices and planning responsibly for the future. MODE_BIOS (MOdel for DEsign of Bloclimatic Open Spaces) proposes a tool for enhancing the sustainability and comfort levels of open public spaces through design operations, adaptive to the specific conditions. The tool will associate ecological guidelines and design practices with place-based inputs in order to generate cost-effective bioclimatic design guidelines for open urban public space. MODE_BIOS presents a hybrid methodological approach, taking into consideration functional, aesthetic, social, technological and political requisites, which are elaborated and prioritized in order to fulfil bioclimatic comfort and sustainability in urban living. The paper presents the stages of MODE_Bios: 1) a targeted Digital Database for urban bioclimatic design principles and case studies is created, based upon bibliographical research and analysis of bioclimatic requirements in urban environments; 2) a Mathematical Model that uses the bioclimatic requirements and the design operations so that through ordering it may suggest the best combination of elements; 3) a Digital Tool that generates guidelines to be used by planners and decision-makers for the improvement of the bioclimatic features of urban public spaces. The suggested operations because of their dynamic and adaptive character can provide a certain level of responsiveness at the integrated elements, depending on the climatic conditions, the crowd concentrations and other variable factors. A case study, for the city of Ioannina, in Greece, will be analysed and presented in the paper. From the case study, conclusions will lead to examine the transferability and scalability, in different contexts of design, of the hybrid methodologies of the MODE_BIOS and also evaluate its links, strengths and weaknesses to other research, tools, projects and policies that address the subject of sustainable urban planning.

KEYWORDS: bioclimatic, adaptive, urban, hybrid, design

INTRODUCTION

Contemporary city planning and urban living policies reflect the urgency of coping with past practices and planning responsibly for the future (Larco, 2015). City planning and urban living policies are difficult to redirect but their importance is crucial for the quality of life of their inhabitants as well as for the global footprint (Bibri, Krogstie, 2017, Gauzin-Müller, Favet, 2002).

Digital technologies have come to the service of the research, by providing sophisticated tools and models that are able to provide guidance, simulate actual physical conditions and predict the impact of interventions to the urban environment (Tsitoura, Michailidou, Tsoutsos, 2017, Angelidou, Psaltoglou, Komninos, Kakderi, Tsarchopoulos, Panori, 2018, Attia, Lacombe, Rakotondramiarana, Garde, Roshan, 2019). These tools, ranging from simple formats to complex models, have been dealing, separately or conjointly, with various aspects of bioclimatic design and comfort requirements, providing approaches that are centered in the quantifiable aspects. Planning is often seen as an additive process of discrete solutions to separate problems regarding thermal comfort, wind environment, radiation, energy efficiency etc., and not as a synthetic one (Katzshner, 2002, Chatzidimitriou, Yannas, 2016),

Additionally, the interventions proposed by many bioclimatic tools are inflexible and can be implemented only in the initial design phase of open public spaces as they do not allow corrective actions in current urban conditions (Allegrini, Orehoung, Mavromatidis, Ruesch, Dorer, Evins, 2015). This aspect constitutes a major drawback for decision-makers and authorities as the cost and/or the inconvenience generated from large-scale interventions is extremely high (Gaspari., Fabbri, Lucchi, 2018). Adaptability in sustainable planning offers resilience to the urban environment, and this is a field of study that needs to be further researched.

MODE_BIOS aims to create a tool for enhancing the sustainability and the comfort levels of open public spaces through design operations adaptive to the specific conditions. The tool will associate ecological guidelines and design practices with place-based inputs in order to generate cost-effective bioclimatic design guidelines for open urban public space. The project's goal is to create links with previous research, tools, projects and policies that address the subject of sustainable urban planning, exploiting previous knowledge and experience, and providing a novel holistic approach.

1.0 MODE_Bios

MODE_BIOS (MOdel for DEsign of Bioclimatic Open Spaces) proposes a tool for enhancing the sustainability and the comfort levels of open public spaces through design operations adaptive to the specific conditions. The tool will associate ecological guidelines and design practices with place-based inputs in order to generate cost-effective bioclimatic design guidelines for open urban public space. MODE_BIOS presents a hybrid methodological approach, taking into consideration functional, aesthetic, social, technological and political requisites, which are elaborated and prioritized in order to fulfil bioclimatic comfort and sustainability in urban living.

MODE_BIOS is based on a hybrid methodology that interconnects abstract and non-measurable qualitative design aspects and bioclimatic, measurable, quantifiable requirements. This enables complex, multifactorial, architectural aspects and their environmental impact to play a role in the prioritization of desired requirements and consequently to the configuration of the MODE_BIOS proposed guidelines.

Design from scratch is a utopian and almost impossible condition in the often-historical European cities. MODE_BIOS provides guidelines for enhancement of the environmental conditions in open urban spaces by suggesting easily implemented and lightweight interventions in pre-existing urban spaces. Adaptability and responsiveness are key elements of the MODE_BIOS, as it offers the possibility of design guidelines that are able to address the changing conditions of the urban environment and adjust correspondingly. MODE_BIOS long-term feasibility is guaranteed by its malleability and resilience and also by its scalable character. The produced tool of the project, related to the implementation of a responsive bioclimatic environment on a certain case study in the city of Ioannina, Greece, and specifically a public square, could be further developed for many urban environments and spatial contexts, after necessary adjustments. MODE_BIOS is both scalable and adaptable and therefore could be adjusted for different scales and typologies of open public space.

Furthermore, it uses dynamic elements of design, as opposed to conventional fixed design features, related to factors such as water, vapor, air, light, shadow, wind, temperature etc. in order to allow a capacity of wide range response to the variable urban conditions. Therefore, the guidelines provided by the MODE_BIOS have a dynamic and shifting adjustment to the changeable needs of the urban environment.

The project's aim is to utilize the shared knowledge on the subject of how design can enhance sustainable urban living in order to provide a decision-making tool for authorities and an operative set of site-specific guidelines for responsive and localized urban interventions.

MODE_BIOS suggests that rethinking our urban living doesn't imply redesigning and reconstructing urban public spaces from scratch, but rather, that it is possible to amend specific features and opt for localized, responsive and easily implemented interventions that can have an amplified repercussion. MODE_BIOS focuses on the creation of a tool capable of generating an operative set of site-specific, cost-effective, bioclimatic, design guidelines for sustainable urban planning and provides a decision-making module for policy-makers.

2.0 METHODOLOGY

MODE_BIOS presents a hybrid methodological approach, taking into consideration multiple factors such as social, economic, technological, political, as well as functional and aesthetic requisites, which are elaborated, classified and prioritized in order to fulfill bioclimatic comfort and sustainability in urban living. It is destined to architects and urban planners but also to authorities and policy-makers, and generally it can be a useful tool to all those involved in environmental design.

The MODE_BIOS methodology divides the actions that will take place and the work that is planned in distinct and discrete phases. Each of them separately reflects a clear-cut methodological approach but all of them together constitute a rather hybrid approach. The proposal's actions are divided in three discrete but interconnected phases, the Digital Database, the Mathematical Model and the MODE_BIOS Tool, which combine clear-cut methodological approaches through a holistic perspective. These three phases cover the requirements for research and theory construction, its shaping into an operative model and user-friendly digital application and finally its testing in a pilot implementation.

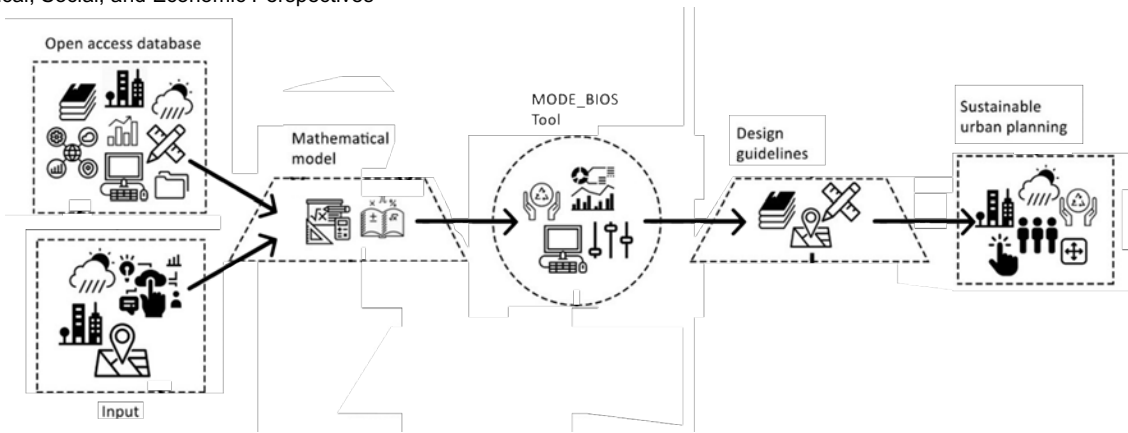

Figure 1: MODE_Bios Concept Diagram. Source: (Mantzou, Floros, 2021)

2.1. Phase 1

In the first phase a targeted Digital Database for urban bioclimatic design principles and case studies is created, based upon bibliographical research and analysis of bioclimatic requirements in urban environments. This initial review and analysis of requirements for environmental comfort in open urban spaces is connected to the research on design case studies creating the basis upon which the next phases will be supported. This analysis and evaluation are indispensable in order to configure the necessary data that will shape the prioritization and ordering of the involved parameters. The construction of a targeted database will associate bioclimatic requirements with design approaches and specific operations in urban spaces that will feed the process of ordering necessary for the mathematical model.

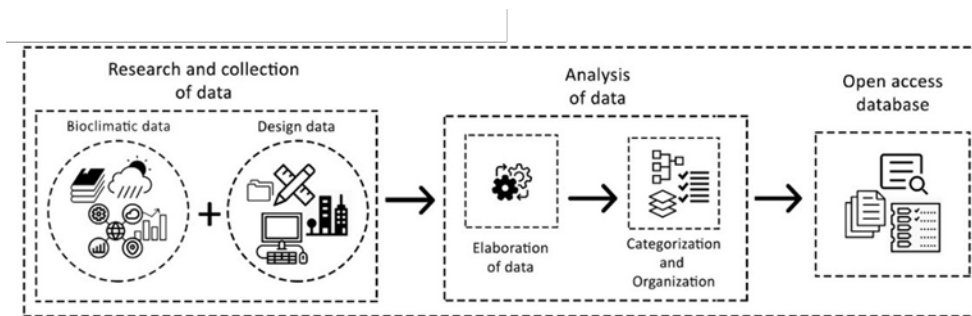

Figure 2: Phase 1: Research, Collection and Analysis of Data. Source: (Mantzou, Floros, 2021)

2.2. Phase 2

The next phase is the design of the Mathematical Model, which will use this prioritization in order to define the least distance from all desired requirements. This will provide guidelines for differential results in a variety of conditions which will take into consideration the site-specific design. The design operations are focused on lightweight interventions, with a dynamic character and a wide range of changing values, such as water, air, etc. The comfort requirements are described for specific urban spaces such as the pedestrian alleys and for the hottest months of the year. The variability factors depend on the site-specific parameters that the mathematical model takes into consideration, as well as the changing conditions referring to people concentrations and climatic data. Following the development of the mathematical model, a digital tool will visualize and make widely possible its use to architects and decision makers.

2.3. Phase 3

The last phase of MODE_BIOS is the creation of a user-friendly Digital Tool, destined to architects as well as decision makers. The tool will generate guidelines for planners and decision-makers to use for the improvement of the bioclimatic features of urban public spaces. The suggested operations will be dynamic and adaptive and therefore, will provide a certain level of responsiveness at the inserted elements depending on the climatic conditions, the crowd concentrations and other variable factors. The tool will put emphasis on visualization techniques in order to achieve a user-friendly interface. Furthermore, it will include a decision-make module that will facilitate stakeholders in strategic planning by taking political, financial, social, environmental and technological parameters into consideration. The design guidelines proposed by the tool will support the targets set by the European 2030 Climate and Energy framework.

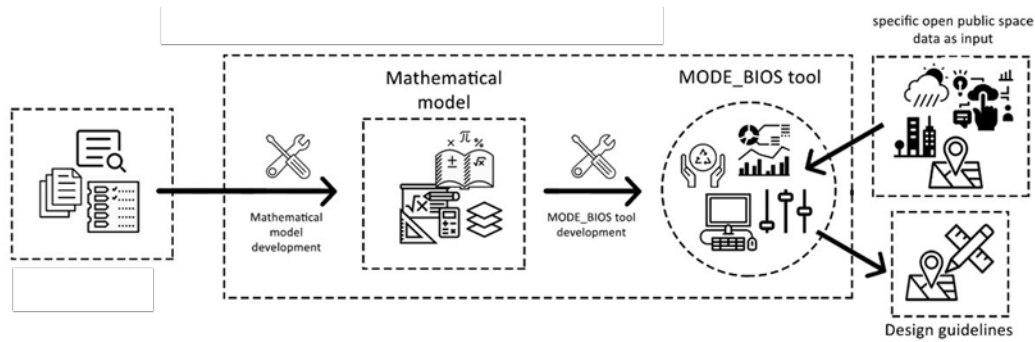

Figure 3: Phases 2 and 3: MODE_Bios Model and Tool development. Source: (Mantzou, Floros, 2021)

3.0 CASE STUDY

A pilot action in the city of Ioannina, Greece, which unfortunately has been delayed due to the pandemic, has been planned and will be used as case study in order to provide the necessary testing of the mathematical model and the digital tool and the required fixing and calibration. Deficiencies and failures of the guidelines provided by the digital tool will be assessed but more importantly the capacity of the lightweight elements to adapt to different requirements and respond adequately will demonstrate their operability and efficiency.

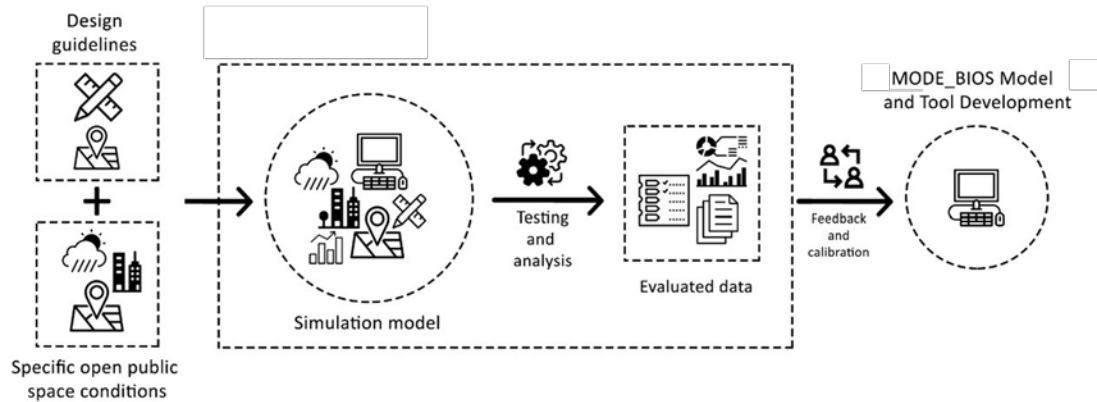

Figure 4: MODE_Bios pilot actions Methodology. Source: (Mantzou, Floros, 2021)

The case study will adopt specific guidelines provided by the mathematical model in real-life conditions and test them in the central square of Ioannina. For this, a set of different apparatuses will be used, in order to better accommodate guests and respond to external circumstances. Temperature, airstreams, humidity, sunlight are conditioned and, simultaneously, electric energy is produced, and Wi-Fi is offered. Integrated sensors will be used in order to dynamically evaluate and adapt the devices to the current environmental conditions.

Criteria applied will be based on the guidelines and adjusted to the variations of climatic occurrences. Users will be able to connect to an app and give feedback on the level of comfort that they feel in the specific environment and suggest personal preferences and possible improvements. Once this testing period is concluded and results are evaluated a second testing period will follow during which users will be able to control and regulate, through the app, the function of the devices and determine the resulting environmental conditions. The devices will perform the users' choices and a record of those preferences associated with the original exterior climatic measurements will be documented. A comparative analysis of the original guidelines, the users' feedback and later on the users' preferences will be executed.

The case study will provide a demonstration of the MODE_BIOS concept and test its application in the actual conditions for a selected time period and for the chosen place. The results of the testing and the subsequent comparative analysis will enhance the tool in terms of functionality through an interactive cyclic process (design-development-evaluation-design). The case study is expected to offer conclusions that will lead to examine the transferability and scalability, in different contexts of design, of the hybrid methodologies of the MODE_BIOS and also evaluate its strengths and weaknesses to other research, tools, projects and policies that address the subject of sustainable urban planning.

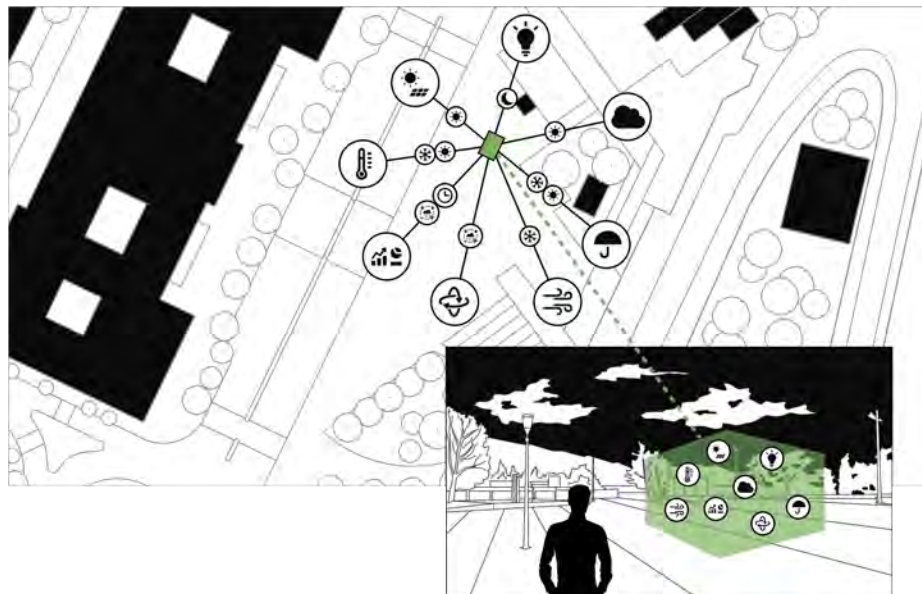

Figure 5: MODE_Bios planned pilot action in the city of Ioannina, Greece. Source: (Mantzou, Floros, 2021)

CONCLUSION

MODE_BIOS proposes a tool for enhancement of sustainable urban living with localized, lightweight and low-cost interventions. It addresses both the design from scratch and the design for particular, restricted interventions to already configured spaces, which are, in many cases, the sole option for improvement of the bioclimatic aspects of an urban space. It presents a primarily design-oriented scope in the fulfillment of environmental requirements for a sustainable urban living.

MODE_BIOS' short- and long-term impact is important on both scientific and social level. As MODE_BIOS brings an innovative methodology in designing sustainable urban places, it advances on current proposals and attempts a hybrid methodological approach that inserts qualitative parameters, such as optimized design practices in correlation to quantitative requirements such as the microclimate measurements. Its scientific impact is relevant for interconnecting specific architectural design practices and sustainability outcomes in open urban spaces. Researchers and scholars will benefit from the new possibilities that the MODE_BIOS opens to shape, access and study sustainable urban design in open public spaces. This can lead to a great impact on the architectural and urban creative processes as it standardizes and visualizes immaterial nuances of the design practice, into quantitative guidelines with measurable results. MODE_BIOS database and Tool demonstrate the multifactorial character of design and raises awareness in the importance of prioritizing quality design as a key to sustainable urban living.

The implementation of the design guidelines proposed by the MODE_BIOS tool in the open urban public space will lead to improved environmental performance and better quality of life for the city's inhabitants. It will also be a useful tool for authorities and decision-makers to upgrade less developed urban public spaces and raise employability for practitioners of sustainable design. The responsive and adaptable character of the MODE_BIOS interventions to the changing environmental and social conditions will lead to resilient, energy-efficient and cost-effective urban public spaces. These lightweight interventions will have a considerable impact upon areas dealing with low quality urban conditions and neglected public spaces. Their revitalization and the consequent enhancement of social interaction will raise awareness on the matter of sustainable urban living and amplify citizens' understanding of the importance of urban planning.

Furthermore, MODE_BIOS is a scalable proposal which can be further developed. Its scalability is both in relation to the type of spaces involved as to the requirements attended. Its impact span can be defined as long-term in regard to its temporal aspect and also easily amplified, in regard to its field of application as it can generate consecutive modules. The lightweight and cost-effective design interventions proposed by the MODE_BIOS are feasible and easily implemented in any open public space and therefore can provide a mitigation of economic and social class distinctions and guarantee social inclusion. This aspect will ameliorate the possibility of all citizens to enjoy high quality urban living without exclusions.

The important challenges that MODE BIOS addresses are i) the standardization of design practices that help fulfill bioclimatic requirements in open public spaces, ii) the construction of a model that associates design practices to amelioration of environmental conditions, iii) the identification of lightweight, easy to implement design operations that can impact the sustainability and comfort of open public spaces, iv) the creation of a user-friendly digital tool that allows decision making on moderate urban interventions with important environmental impact and v) the testing of the adaptability and the responsiveness of these interventions in the variation of values relative to climatic and social conditions.

REFERENCES

- Angelidou, M., Psaltoglou, A., Komninos, N., Kakderi, C., Tsarchopoulos, P. and Panori, A. 2018. *Enhancing sustainable urban development through smart city applications*. Journal of Science and Technology Policy Management, 9(2).
- Allegrini, J., Orehounig, K., Mavromatidis, G., Ruesch, F., Dorer, V. and Evins, R. 2015. *A review of modelling approaches and tools for the simulation of district-scale energy systems*. Renewable and Sustainable Energy Reviews, 52.
- Attia, S., Lacombe, T., Rakotondramiarana, H.T., Garde, F. and Roshan, G. 2019. *Analysis tool for bioclimatic design strategies in hot humid climates*. Sustainable Cities and Society.
- Bibri, S.E. and Krogstie, J. 2017. *Smart sustainable cities of the future: an extensive interdisciplinary literature review*, Sustainable Cities and Society, Vol. 31.
- Chatzidimitriou, A. and Yannas, S. 2016. *Microclimate design for open spaces: Ranking urban design effects on pedestrian thermal comfort in summer*. Sustainable Cities and Society, 26.
- Gaspari, J., Fabbri, K. and Lucchi, M. 2018. *The use of outdoor microclimate analysis to support decision making process: Case study of Bufalini square in Cesena*. Sustainable Cities and Society, 42.
- Gauzin-Müller, D. and Favet, N. 2002. *Sustainable architecture and urbanism: concepts, technologies, examples*. Basel; Boston: Birkhauser.
- Katzshner, L. 2002. *Bioclimatic characterization of urban microclimates for the usage of open spaces*, Proc.: Architectural and Urban Ambient Environment, Nantes.
- Larco, N. 2015. *Sustainable urban design – a (draft) framework*. Journal of Urban Design, 21(1).
- Tsitoura, M., Michailidou, M. and Tsoutsos, T. 2017. *A bioclimatic outdoor design tool in urban open space design*. Energy and Buildings, 153.

Rebellion, Robotics, and a Radical Reboot: Emergent Processes in Turbulent Times

Dustin Couzens¹, Brian R. Sinclair², Ben Klumper¹

¹Modern Office of Design + Architecture (MODA), Calgary, CANADA

²University of Calgary + sinclairstudio inc., Calgary, CANADA

ABSTRACT: Over past decades we've witnessed dramatic, often unsettling, upheaval within structures and systems that shape how we live, understand, discover, and design. Paramount in equations are catastrophic implications of global warming, whereby climate disasters increase, resources deplete, and quality of life is in jeopardy. Recent crises, including the global pandemic, widening economic gaps, shifting migration, and escalating political disarray, call for intense rethinking, and potential redesign, of modus operandi. Contained fundamentally in the calculations are architecture + building. The building industry is a major contributor to the predicament, including but not limited to heightened greenhouse gas emissions, burgeoning landfills, and escalating energy consumption. While historically architecture must assume liability, on a positive note design offers remarkable opportunities to right-the-ship and proffer hope. The present research acutely considers the potential of advanced technology to strengthen design, streamline production, foster wellness, and improve quality of life. Aiming centrally at novel yet ubiquitous technologies, including robotics, artificial intelligence, prefabrication and smart buildings, the research critically interrogates divides between ways we design + make and the manners in which we operate + occupy built environments. Methodologically the research comprises manifold strategies: interdisciplinary literature review, analysis of leading precedents, interviews with design + manufacturing experts, focus group sessions, and critical consideration of pioneering case studies (building industry plus technology, scientific, humanities, political sectors). It is a speculative, perhaps provocative, first step out on a broader & deeper research path, intended to raise issues, prompt questions, and set a trajectory. The internationally oriented research, creatively bridging academia & professional practice (researchers are embedded in both realms), presents a picture of a quickly moving field and argues for a radical reboot of ways we as architects and environmental designers see, think + act. The paper concludes with a conceptual framework illustrating how a reboot can be structured, promoting active uptake of evolving means to address climate change, heighten efficiency, assume accountability, promote health, and improve quality of life for consumers of architecture and the city.

KEYWORDS: architecture, catastrophe, systems, technology, quality-of-life (QoL)

1.0 INTRODUCTION

"Design is a multifaceted subject. It ranges from the smallest manufactured objects to the planning of cities, regions and entire countries. In today's world it is not only local but inevitably global." Cairns, 2014¹

Without question societies globally confront a changing milieu whereby the ways we conceive, construct, and occupy the built environment are in dramatic flux. Notions of solidity and stability are under question while certainties, expectations and impacts alter in unforeseen ways. From routine daily activities, such as driving, dining, or dwelling, to existential assaults on species and the planet, civilization is encountering unprecedented pressures. Growing awareness concerning the gravity of previous actions, such as resource depletion and greenhouse gas generation connected to advancing the industrial complex, now places many industries and professions in a position where 'business as usual' is untenable. The architectural profession, and the construction industry writ-large, cannot escape culpability in said scenarios. In fact, the construction and occupation of buildings and the built environment, from embodied energy to operational implications, proves a major player in such existential crises. However bleak the outcomes of previous actions may seem, the architectural enterprise, and design in a much broader way, hold critical keys to tackling many modern dilemmas and to charting paths forward that endeavor to right some wrongs and repair some damage. In many ways, at the present juncture, inaction is neither a viable nor responsible option.

When we begin to understand the nature of many contemporary problems it becomes clear that design, as a problem-solving vehicle, affords society many ways of seeing, thinking, and acting that could lessen or even reverse the implications of a difficult trajectory. When we consider the potency of design, and its ability to transcend conventional boundaries, it provides both cause to pause and encouragement that we do have real choices and grounds for optimism. Many problems over recent decades have been amplified through the arrival and deployment of advanced technologies -- from the pervasive deployment of the combustion engine to the omnipresent power of the silicon chip our lives have been changed in remarkable yet now, in hindsight, concerning ways. Without question the quality of life

in many parts of the world has been exceptionally elevated. Cities have developed as major cultural, social, and economic engines, with rich fabric and unparalleled amenity. Buildings have grown in sophistication, size, and service, whereby they often house comprehensive communities and serve as vertical cities. However, as has been made abundantly clear in recent times, this tsunami of progress and privilege has come with severe consequences.

The present research accepts this troubling environment as a starting point for a major examination of forces and factors at play, and a dramatic reset -- what we call a radical reboot -- of our *raison d'être* and our *modus operandi*. In other words, as architects we must crucially reconsider and redesign both our purpose and our means.

2.0 DELINEATING THE APPROACH

“Typically theory is understood as an overarching philosophy governing certain aspects of practice. The objective of theory is to establish something fundamental about how we act in the world, a result of considerable analysis and rationale.” Lucas, 2016ⁱⁱ

The present paper, as a window into a larger and longer-term research agenda, introduces the work of the team considering new ways of approaching, engaging and executing architecture. As such the content is on one hand descriptive and delimiting, while on the other hand speculative and provocative. Embedded within the broader agenda are discrete yet inter-related investigative steps, including a Prix de Rome program, a Venice Biennale installation, and ongoing local, regional, national, and international projects (e.g., scholarly, professional, public, private, etc.) aimed at design education and design practice. Taken together these studies and initiatives form a body of research that informs, inspires, and influences the ‘radical reboot’. This paper examines this range of engagement, delineates key aspirations, reveals preliminary findings, and synthesizes a new way of organizing ways of seeing problems and seeking solutions.

2.1. Goals

Given the dire consequences of inaction, the present research critically considers how our ways of educating and practicing can shift to better respond to mounting challenges within society. In particular, we are aiming to reimagine how our design and build processes can morph in ways that address concerns, harness technology, improve efficacy and, broadly, usher in higher-quality solutions. The ways in which quality is defined and delivered is, of course, at the heart of our studies, our aspirations, and our actions. Arguably there are many ways of viewing and assessing quality in buildings and of the built environment. There are significant cultural and contextual ways of understanding quality in design and the quality of life in built environments. The researchers accept that diversity is fundamental to the work at hand, and that definitions of quality will see regional nuance and contextual adaptations. That said, we believe there is common ground that architects, and agents of design, should operate within when chasing innovation and structural realignments.

The goals of the present research are:

- To conduct environmental scans (via literature reviews and system networking) to better understand the nature of contemporary architectural problems;
- To examine architectural education as a preparatory vehicle to better match professional competencies with desired outcomes;
- To investigate modes of architectural practice that realize better traction and more positive impacts in raising quality of buildings and the built environment;
- To consider the potential and power of emerging technologies, both computational and constructional, to render more impactful and positive changes in our communities and in our cities;
- To envision and craft a conceptual framework that can both advance and propel further research while concurrently offering some inspiration and guidance to educators, practitioners, clients, and authorities charged with creating and managing buildings and the built environment.

2.2. Research Methods

“It was incredibly important for us to induce a sense of freedom of movement, a milieu for strolling, a mood that has less to do with directing people than seducing them. Hospital corridors are all about directing people, for example, but there is also the gentler art of seduction, of getting people to let go, to saunter, and that lies within the powers of an architect.” Zumthor, 2010ⁱⁱⁱ

The present research deploys several tactics in addressing the larger aforesaid goals of the agenda, and most notably through intertwined interdisciplinary (mixed qualitative and quantitative) methods. Methodologically the research comprises manifold strategies: interdisciplinary literature review, analysis of historical and contemporary precedents, interviews with design + manufacturing experts, focus group sessions, and critical consideration of pioneering case studies (building industry plus technology, scientific, humanities, political sectors). It is important to underscore that the present paper outlines both the philosophic underpinning of the broader (albeit initial) investigatory agenda and the initial research steps conducted to date. In other words, the paper is concerned about delineating a longer-term roadmap that guides research thinking into reform of education and practice, while depicting a shorter-term series of

steps and projects that contribute to our (the research teams) understanding of the cultural, contextual, and circumstantial facets that shape buildings and the built environment. Such immediate efforts are illustrated through, most notably, the illumination of contemporary conditions of practice (e.g., shaped via emergent technologies) and the architectural projects included in the paper (e.g., shaped via shifting societal expectations). The present paper reveals several windows into this larger, longer-term, complex, comprehensive, and demanding research agenda.

Three dimensions of the research, both in the longer-term agenda and in the shorter-term activities, warrant further delineation. They are vital qualities of the investigatory approach and serve to shape thinking and sharpen lenses.

Design as Research: While many aspects of the research approach are arguably conventional (i.e., typically strategies deployed in major research institutions), one prong of the current research that is both robust and critical is 'design as research'. All members of the research team are immersed in both education and practice. On the practice side, projects are viewed as vital vehicles to explore innovation and to move theory into practice (i.e., the ethos of praxis). Included in the present paper are two actual design projects that serve to advance thinking and test theories, of note as pertains to the idea of a 'radical reboot'. Design, in this sense, is a living laboratory whereby concepts are examined for impact and efficacy, in particular as they address the many pressures on modern life and as they hold promise to lessen the impacts of looming crises.

Embedded Research/ers: A key feature of the present research, and longer-term agenda, is that all members of the research team are embedded agents in the ethos at question and are engaged players in the design pursuits underway. In this way the research benefits from on-the-ground testing and direct feedback. Advancing thinking in an academic setting, while important on many counts, is disadvantaged in terms of real-life applications. Practice, on the other hand, affords researchers a critical opportunity to test concepts, to gauge market acceptance, to construct architecture, and to solicit immediate and tangible feedback. Being embedded is, of course, a double-edged sword. To this end, the research team accepts some limitations around bias while also inviting the benefits that accrue when 'tires can be kicked' in-situ.

Systems Thinking: Moving ideas from a lab situation (in-vitro) into a field situation (in-situ) carries many implications. Without question the task of moving a building project from concept through construction comprises a messy, complex, and demanding journey. Design has often been cast as being capable of coping with 'wicked problems' and of managing wildly complicated processes of implementing ideas in environments characterized as 'messy vitality'. While a lab situation proffers capacity of variable control and management, things get less clear in the rough and tumble reality of 'real life'. The present research is clearly resident in the world of the everyday -- in the market where architectural services are procured and buildings are constructed. As such, the researchers are intensely committed to understanding the systems in effect and the interrelationships at play.

2.3. Structure and Anticipated Outcomes

The present paper, proffering several windows into the manifold research agenda underway, is structured to provide two key deliverables: namely, an understanding of major forces and factors at play and under consideration for a 'radical reboot' of the profession, and an exploration of significant architectural projects that provide inspiration and information to assist us in reshaping both the education of architects and the conduct of architectural practice. The anticipated outcomes at this, preliminary, phase of the greater research agenda include a delineation of parameters that will shape subsequent research as well as a conceptual framework that will guide seeing, thinking, and acting moving ahead.

3.0 DEPICTING THE PROBLEM

"There are no rules of architecture for a castle in the clouds."^{iv} Chesterton, 1925

Based on the literature review for the research agenda, focused on key subjects such as design, architecture, the built environment, quality of life and city building, the researchers gave shape to the landscapes where design transpires, and the 'radical reboot' will happen. The forces + factors at play are many and consequential -- in essence comprising the intense pressures for change that impinge on us locally, regionally, nationally, and internationally. The following sections of the paper endeavor to paint a picture of components of the milieu of practice that prove especially germane to a rethink of ways and means (to produce buildings, spaces, and places).

3.1 Society

Undeniably our modern world has transformed, and is transforming, in ways inconceivable even a few decades back. From economic upheaval and climate change to political instability and public health assaults, societies around the globe confront intense and unprecedented challenges to quality of life, and even to life itself. While some crises have been anticipated and managed to some degree, others have been unexpected and debilitating. In part a result of rapid population growth and increased global mobility, and in part a consequence of endemic fragmentation and an unbridled appetite for progress, today's world is replete with problems that seem to rise in numbers and increase in consequences. Architects, while historically cast as serving narrow markets and offering luxury services, can no longer reside on the

sidelines and shelter in the shadows. In fact, to the contrary, architects and design stand as remarkable agents for positive change. The present research, and researchers, accept that architects and a quest for buildings have been major contributors to current crises, and assume that architects and the provision of buildings, moving forward, can be major contributors to healing, restoration and regeneration.

3.2. Technology

At the core of many equations around crisis and opportunity, in our current times, is technology. Viewed by the researchers as both blessing and bane, technology (both computational and constructional) comes to us as a powerful tool and as an unmitigated risk. Plato referred to the Pharmakon -- that is, a medicine that can be rendered as poison or remedy contingent upon application, politicization and so forth. History provides us with countless examples of pharmakons that cut both ways -- for example, the combustion engine, nuclear technology, and the internet. In all three of these cases, we see both positive impacts and devastating consequences. The present research accepts that technology can get us into greater trouble or can lift us out of existing quagmires. In many ways the path chosen must be based on evidence in decision making and risk acceptance in pursuing innovation. In this paper, and in its associated research agenda, technology must be deployed with an open mind, a courageous outlook, and some solid grounding (based on facts, findings, clarity, and creativity).

3.3. Sustainability

Over recent decades, and certainly since the Brundtland Commission, the notion of a more sustainable world has stood large in our minds and weighed heavy on our souls. The pursuit of a more viable and responsible society, where future generations hold more sway than current consumers, is both noble and essential. In the realm of architecture and design, ideas around sustainability and environmentally conscious action have been in the foreground. Programs that assess and rate the 'greenness' of buildings, and of communities, have fortunately proliferated - with widescale subscription by clients and broad policy adoption by governments. The design professions have willingly embraced sustainability as key to a better future - both for the professions but more importantly for the users of buildings and the occupants of cities. Within the current research agenda, the gravity of sustainability is undeniable. That said, the researchers see sustainability in ways that differ from the status quo. The idea of Agile Architecture is paramount in this approach, whereby flexibility and mutability stand central in any definitions of sustainability. The days of static buildings and stoic construction need to be behind us, replaced with projects that respect circularity, buildings that are primed for disassembly, and facilities that can morph based on user needs (as opposed to users contorting into intractable spaces and places).

3.3. Trajectory

In considering research, practice, problems, and projects from the literature work of this study, it is clear that a new trajectory is essential. Many challenges facing our contemporary world are building in scale and escalating in impacts. It is no longer reasonable to wait for others to act. Architects need to understand the milieu, assess the options available, then take steps to reconsider and redesign the ways we see, think and act. The present research, developing a 'radical reboot', aims to alter our trajectory - both as design professions and as a larger construction industry. While such aspirations are grand, the research aims to manage the change beginning at the level of architectural education and practice, and most notably through an aggressive realignment of processes based on societal expectations, technological empowerment, and reconceived lenses on sustainability.

4.0 EXPLORING THE CASES

4.1. Precedents

To create tomorrow it is valuable to learn from yesterday. The research examined three historical projects that serve to influence and inform further study and consideration of a 'radical reboot' of design and practice. These three projects, the Nakagin Capsule Tower, New Babylon, and the Fun Palace, are located in different geographies and respond to diverse forces (societal, technological, cultural, social, economic, and so forth). Despite such difference, all projects were visionary, bold, and willing to challenge prevailing conventions of their time and place. The current research drew great inspiration from the architects and designers that pioneered these historical cases. The following are brief descriptions of the projects and, crucially, lessons learned as we advance the research agenda and associated design work.

4.1.1 Nakagin Capsule Tower: This project, by noted Japanese Metabolist Kisho Kurokawa, aimed to alter the ways we inhabit the city and the way occupation transpired. Onto several rigid service cores were affixed dwelling modules, or capsules, that efficiently and flexibly allowed residents to live, work and play. The concept for the tower, located in the Ginza district of Tokyo, was that highly rationalized and efficient residential pods would plug into the cores -- with an ability to swap out modules as needs shifted and circumstances warranted. Despite this brave model, since the project's opening in 1972 not a single module or capsule has moved. While the reality of agility did not materialize, the remarkably progressive design for this project provides great motivation for the present research. Kurokawa's vision for this ingenious project was far ahead of the prevailing technology's ability to keep pace. The lag in technology in no way diminished the power of the concept -- to have architecture shifting to meet changing needs versus forcing users to change to accommodate rigid buildings. Concept + Inspiration = Building Modularity

4.1.2 New Babylon: A brilliant and progressive urban proposition, conceived of by the forward-thinking visual artist Constant Nieuwenhays in the 1950s, New Babylon considered the ability of urban conurbations to accommodate diverse ‘situations’. With the provision of unimagined freedoms, in space, time, function and activity, dwellers had the ability to exercise desires in profound ways. The facilitation and satisfaction of wants and needs through the iterative and responsive nature of architecture and urban design was exceptionally advanced for its time. Concept + Inspiration = Urban Resiliency

4.1.3 Fun Palace: British Architect Cedric Price conceived of the Fun Palace as a realm of flexibility, where change of function and configuration was readily fostered by a kit-of-parts approach. Spaces could morph over the course of a day or through a week, with a neutral shell transformed readily to meet shifting requirements of a diverse user base. While unconstructed, Price’s vision for an architecture quickly disassembled then reassembled was far ahead of its time. Concept + Inspiration = Architectural Flexibility

4.2. Contemporary Design Cases

“The creation of place, buildings, cities and landscapes has traditionally been conceived as a monumental art, as the creation of lasting artifacts that embody the achievements and ideals of a civilization. However, despite the current volatility of economics, climate, war, politics, technology and culture, the places in which we live, work and recreate are becoming increasingly predisposed to obsolescence, impermanence and transience.” Yona Friedman

A vital component of the present research is the study and testing of ideas in practice – that is, moving from the realm of theory into action. The researchers have extensive experience, in academia and practice, operating across realms and between concepts and constructions. Drawing from the historical precedents, and gaining insights from the literature reviews, the present paper delineates three projects that each aim to showcase a different pursuit or ethos: Building Modularity, Urban Resilience, and Architectural Flexibility. As noted previously, the present paper is a window into several essential aspects of the broader and longer-term research agenda. The following projects are explored briefly to showcase approaches and build understanding. Future research is anticipated to heighten understanding of our (societal and professional) responses to intense forces, factors, problems, and crises at hand.

4.2.1 Winnipeg Warming Huts (2020) | Building Modularity: This project was the winning entry/project for the intriguing and high-profile Winnipeg Warming Hut Competition. Conceived as a small shelter or hovel, S(Hovel) reimagines an everyday, off-the-shelf article of winter – the snow shovel – into a swirling vortex of mystery and intrigue that only reveals its true identity upon closer inspection and inhabitation. Built from 214 aluminum shovels and conventional ring-lock scaffolding, we challenged ourselves to design a warming hut that could be built and subsequently disassembled using unspecialized labour furnished with only a hammer and a hand drill! Designed for disassembly, S(Hovel) is destined for a philanthropic afterlife in which, following its stint as a Warming Hut, the 214 shovels will be donated to Snow Angel Programs, non-profit charities that assist seniors and the infirm with snow removal each winter season. This circular life cycle enables S(Hovel) to infiltrate the larger community of Winnipeg, enticing the multiple narratives of winter’s spectacle to unfold.



Figure 1. Winnipeg Warming Huts Project (MODA, 2022)



Figure 2. Holistic Framework for Design + Planning (Sinclair, 2022)

4.2.2 Holistic Model for Design + Planning | Urban Resiliency: Traditionally design and planning function in quite fragmented and isolated ways, with narrow scope setting the direction for design, approvals, funding, development, implementation, and so forth. The Holistic Model for Design + Planning runs counter to this reality, embracing systems theory and systems thinking to bring ideas, player, politics, financing, and other parameters into the same sphere -- basically bringing other disparate actors and activities into a common and ethical space. The model calls for equitable attention afforded to multiple dimensions of a project -- bringing concepts, consultants, clients, government, users, and other stake + rightsholders into conversation. The notion is not to define quantitative and finite solutions to a design or planning challenge, but rather to cultivate discussion aimed at finding paths that are effective and appropriate. The model finds application and relevance across scales, from single building projects to large mixed-use developments.

4.2.3 FARM (2020) | Architectural Flexibility: This project, a World Architecture Finalist, explores the potential of architecture to accommodate growth and change in simple, clear and affordable ways. Here today, gone tomorrow... This sentiment resonated with the client – a developer in Edmonton, Alberta, Canada – who, in their brief for a new 1100 sm commercial project challenged the architects to conceive a building more as an event than object as a means of temporarily developing and occupying one of their inner-city sites. Even though privileging the temporary and the ephemeral provides a bridge to the immediate, this not only implicates long-standing traditions of the architectural profession, but also challenges sustainable rhetoric which cites new construction as contributing approximately 40% of the worlds carbon emissions. This line of thinking favours permanence over impermanence as the “more responsible” design approach. In response, design began by researching the principles of circular design, which advocate for a cradle-to-cradle ethos towards construction, engendering a novel life-cycle approach to design that is less preoccupied with permanence than it is with designing for circularity, disassembly, and impermanence. Circular design is ushering in newfound freedoms and sensibilities towards sustainability that are prompting architects to question the notions of monumentality, fixity and stasis within our physical environment. With FARM, design began by producing a taxonomy of agricultural vernacular typologies of the Canadian prairies. The architects became enamoured with the bucolic beauty of Quonset huts and their modular, prefabricated assembly logistics. Responding to our client’s desire for a project with a ‘shelf life’, we challenged ourselves to design a building in which all components could easily be disassembled. Every major component – from the screw-pile foundation system to the modular, structural steel rib envelope, to the insulative ‘pillows’ that are mechanically fastened back to the structure, to the panelized interior finishing, to the interior concrete block walls that are mortared together using dissolvable, cementitious grout, and to the modular glazing units – can be efficiently taken apart and up-cycled. Ninety percent of the components used in the building will be indexed using material passports that will produce a database kit of parts to aid in the future reuse or re-purposing of the building, either wholly or in part. The building is comprised of several Quonset huts ganged together, providing an inherent spatial flexibility whereby a tenant can occupy one, several or all the bays. The modular approach to construction enabled by Quonset hut technology allows each bay of the building to recede at points of public interface, and tear apart in unexpected instances, producing secret gardens and courtyards that not only provide spectacle but also allow daylight to penetrate the building’s interiors, providing an ethereal light that accentuates the building’s barrel-vaulted form from within.



Figure 3. FARM Project, Edmonton Canada (MODA, 2022)

5.0 CONCEIVING THE FRAMEWORK

“At some point architecture lost its mission to change society. It is largely because architecture has become a tool of capital. But I believe that, limited as it may be, architecture still has a power to propose something to society, or has some role to play in society.” Ito, 2012⁴

Complexity has always been inherent to the tasks of designing buildings and building cities. In the present research

there is an overarching concern to find better ways to tackle problem-solving in the built environment. To such ends, the researchers argue that traditional processes are dated and increasingly ineffective. As we have noted, societal problems are daunting in complexity and consequences. Technology is rapidly appearing and yet often reluctantly and conservatively deployed. Fragmentation of approaches to design and planning often proves limiting and impotent. All of this said, and considering the aforesaid literature work, precedent studies and contemporary projects, the researchers have shaped a framework that will guide future work (both research projects and key national and international initiatives such as the Prix de Rome and Venice Biennale). Our framework embraces five components that are both intertwined and symbiotic -- leveraging emerging technology and subscribing to systems theory, they intentionally relate to our previously underscored aspects of Building Modularity, Urban Resilience and Architectural Flexibility.

5.1. The Framework for a Radical Reboot of Architecture

“In all Open Building projects, design decisions are made on two levels: the lower level of interior fit-out is to accommodate the user, while the higher level contains all that the users have in common: the load bearing structure, the main utility systems, and the public spaces.”^{vi} Habraken, 2005

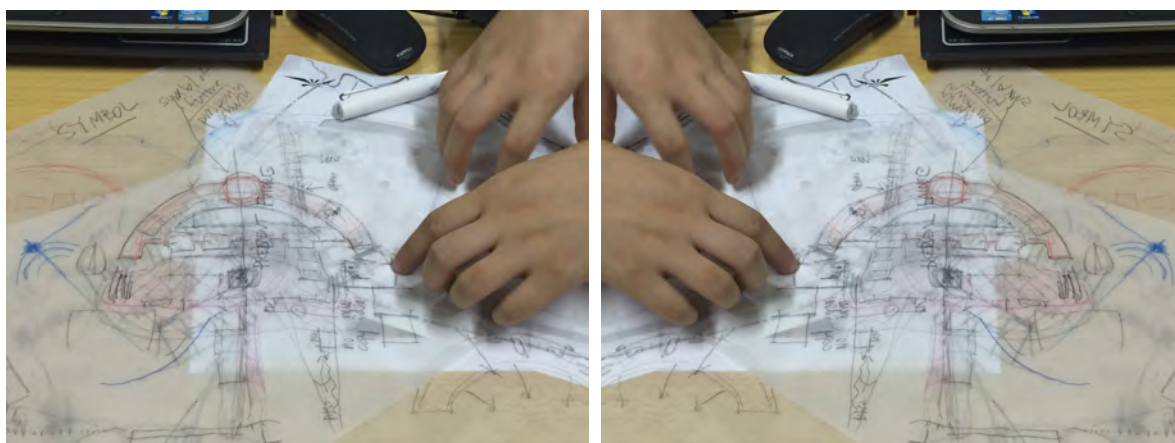

Figure 4. The Potency of Design and the Power of the Studio (Sinclair, 2022)

Our framework presents the following five aspects as key to innovatively deploying emerging technologies to the betterment of environments and their users. No one aspect is paramount -- rather all need to be addressed in concert as we seek to discover more powerful ways of realizing buildings and communities with humanity front of mind.

In-Situ Fabrication: If robots are to be employed in large-scale construction, logistics and ways of making need to be entirely rethought. In-situ fabrication allows for the continuous projection and erection of large format or even complex construction systems.

Digital Materiality: Digital Materiality suggests that instead of copying long-established construction methodologies, we should fundamentally re-think the very act of ‘making’ through inventing novel fabrication processes (e.g., Mesh Mold, Smart Slab, Spatial Timber Assemblies, etc.) derived directly from the logic of the given materials.

Mass Customization: Efficiencies in time, cost, speed, efficiency, quality, and environmental sustainability (as they pertain to robotic fabrication) are enabling mass customization at the scale of architecture. In addition, the ability to mass customize the ‘parts’ that comprise architecture is enabling a wide range of outdated architectural topics, such as ornamentation or detail, craft or craftsmanship, cultural vernacular, and architectural history, to re-enter current architectural debate.

Artificial Intelligence: Recent advancements being made in both A.I. and Machine Learning have paved the way for ‘sensing robots’ that are capable of troubleshooting, recalibrating, and responding in real time to the myriad of complexities that arise on a construction site, facilitating an open-ended feedback loop that is critical to constructing at full architectural scale.

Robotic Entrepreneurship: Lastly, an emerging trend towards ‘entrepreneurship’ in which architects are diversifying the services they provide through folding robotic fabrication technologies and architectural practice into a single milieu. Not only does this reinvest in our profession’s diminishing agency towards the making of our physical environment in a more socially, culturally, and environmentally sustainable way, it also opens the door with respect to operating in tangential industries.

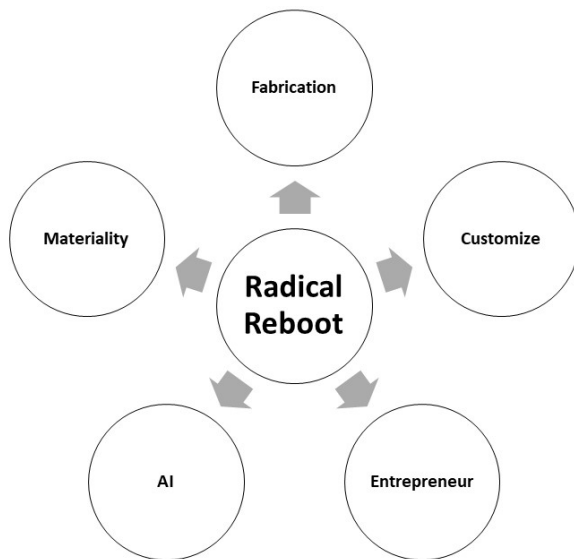

Figure 5. Conceptual Framework for Radical Reboot (Couzens, Sinclair + Klumper, 2022)

6.0 ANTICIPATING THE IMPACTS

It seems clear that architectural design -- including architectural education and practice -- need reconsideration, reform, and reboot. Societies around the planet are shifting in outstanding, if not worrying, ways. In order to positively impact the processes, policies, and principles of architectural creation, it is insufficient to tinker around the edges and tweak current approaches. As we have argued in the present paper, a dramatic turn in perspective and practice is urgently in order. While the research agenda is in its early stages, the anticipated impacts are manifold. As educators and practitioners, the research team stands intent on serious curricular revisions to education and bold tactical changes to practice. Of course, issues around policies and the viewpoints of authorities with jurisdiction loom large, and as such stand as objectives to address as the research advances.

7.0 CONCLUSION + NEXT STEPS

“Interweaving of humanist principles and architectural design appears to be a fruitful and optimistic path for designers.”^{vii}
Lyon (2017)

The present paper has aimed to describe the early stages, and foundational principles, shaping both near and far term goals for a broader research agenda targeting a radical reboot of architecture. Quality in the built environment, including building design, is an issue front and center in cities around the globe. As our planet sees growing urban settlement and increasing pressures on development, the need to get design ‘right’ increases exponentially. We know that the ways we design has implications on the ways we behave and feel (physically, socially, psychologically, etc.). The recent global pandemic has put a serious spotlight on architects and design, illuminating the implications of poor design while highlighting the benefits of good design. Of course, how we define good design, or quality in design, is core to any arguments for a radical reboot. The present research, incorporating literature reviews, examination of historical precedents, and consideration of current projects (from theory and practice), concluded with the development of a 5-part framework that seeks to harness technology, embrace humanity and, in the end, generate more appropriate, effective, and sustainable design. The ability of design to better respond to and accommodate user needs, and societal expectations, is fundamental. Following from this initial ‘step out’, or introduction of the research principles, the research team has a series of subsequent programs -- both academic explorations and design projects - geared to generate insights and evidence important to further shaping the conceptual framework and to advancing a radical reboot of architectural education and practice.

ⁱ Cairns, Graham (Editor). *Design for a Complex World: Challenges in Practice and Education*. Libri Publishing: Oxfordshire, UK. 2014. Page xiii.

ⁱⁱ Lucas, Ray. *Research Methods for Architecture*. Laurence King Publishers: London, UK. 2016. Page 9.

ⁱⁱⁱ Zumthor, Peter. *Atmospheres*. Birkhauser: Basel, Switzerland. 2010. Pages 41-41.

^{iv} Chesterton, G. K. (1925); *The Everlasting Man*; Hendrickson Publishers (Revised in 2007)

^v Ito, Toyo. *Forces of Nature*. Princeton Architectural Press: New York. 2012.

^{vi} Habraken, N. J. The Next 21 Project in the Open Building Context. In *Next 21: All About the Next 21 Project*. Editors: Next 21 Group. Osaka Gas Company: Osaka. 2005

^{vii} Lyon, Corbett. “Humanistic Principles, Sustainable Design and Salutogenics”. In *Design for Health: Sustainable Approaches to Therapeutic Architecture*. Editor: Terri Peters. *Architectural Design*. No 146, March/April 2017. Pp 56-65

Uncertainty, Complexity + Changing Conditions: A Cohesive Frame To Advance Agility In The Built Environment

Salah Imam¹, Brian R. Sinclair²

¹University of Calgary + Entuitive Consulting Engineers, CANADA

²University of Calgary + sinclairstudio inc., CANADA

ABSTRACT: Buildings are arguably more meaningfully approached as process versus product. A zero-carbon structure with no robust functional flexibility will become obsolete long before its physical life concludes. Robust sustainability, as viewed through the present research, resides at the nexus of durability, flexibility, and responsibility principles. The authors suggest such principles are not mutually exclusive nor incompatible with values of aesthetics and performance. Through the study of flexible architecture, particularly in residential projects, this paper establishes a novel multi-criteria decision-making framework for design projects. The theoretical framework, offering holistic and unified design criteria, corresponds to physical, functional, economic, technological, social, legal, and political facets that instigate and propel building. The methodological approach of the research follows three sequential stages: literature meta-analysis, survey of experts, and case studies. Theory is evoked, including recent considerations of open building, holistic design, and systems thinking (Langston 2014, Sinclair 2012, 2015; Imam and Sinclair, 2018, 2020, 2021). Industry perceptions regarding environmental, social, and economic tenets of sustainable development are identified via a purposive survey with 69 architects and researchers. Seminal cases of eight (8) award-winning projects are drawn from regions with the highest reported current and projected floor area, illustrating agility concepts in design, legislative, and/or financial ethos. Case study data, together with the strategic literature review and survey, highlights leading themes, suggesting agile systems that are composed of four key characteristics: 1) diverse approaches and strategies that can learn (design intelligence), 2) the relationship among systems and subsystems is nonlinear, 3) co-evolve with their environment, and 4) display emergent properties. The large-scale impact of climate change, now complicated by the pandemic, calls us to be resilient and more open-ended in designing our built environment. Agility proves a compelling means to proffer more inclusive distributed decision-making structures appropriate for daunting and rapidly evolving realities of contemporary life.

KEYWORDS: Agility, sustainability, flexibility, systems, holism, decision-making, design

INTRODUCTION

In a society plagued with seemingly more environmental and health problems, the notions of adaptation and responsiveness are all too prevalent. As human beings, we look in all places for holistic wellness and quality of life. Most building projects have a life expectancy, and for infrastructure projects, life can be very long. Nevertheless, we do not know what the world will be like in the future—*who can predict social change, technological change, or climate change?* There is a significant risk that today's well-intentioned design decisions will turn out badly. As many people have realized, it is a good idea to design for *flexibility*. Yet, most research in this field expose but do not probe. Obvious questions that might and should be asked after the vast amount of evidence offered in the literature remain unanswered. For example, why is it that, *after more than a century of attempts to design for flexibility, the issue is still marginalized to the profession at large?*

The term *flexible* has a very broad definition in architecture, in part to allow the inclusion of a range of strategies that provides adaptability in response to a particular change or need. In one definition, flexible buildings are "designed to respond easily to change throughout their lifetime" (Kronenburg, 2007, p. 6), and in another, it is a building "that can adjust to changing needs and patterns, both social and technological" (Till and Schneider, 2007, P. 4). While there are many ways one might define *flexibility* and *adaptability* with respect to building design, it is obvious that to endure a building for a prolonged period; the structure needs support from more than just the environment. In other words, architecture must be functionally, economically, and technologically relevant. Thus, this paper introduces a measure that is more independent, responsive and holistic; a measure that integrates aspects of durability, flexibility and responsibility; a measure that introduces layers of physical, social, environmental and economic factors in the form of continuously evolving and dynamic framework; a measure that we refer to as *Agile*.

1.0 BACKGROUND

"A concern for greater flexibility in buildings arose in the 1950s as a reaction against the excesses of 'form-follows-function', which argued that all parts of a building should be determined by, and destined for, specific uses. In practice,

however, even if these uses could be identified, no allowance was made for new developments over time, yet alone the changes of use that happen in many buildings." (Weston, 2011)

The idea of integrating flexibility to accommodate future needs as well as minimizing energy footprint throughout the physical life of the building is undoubtedly the ultimate holistic objective for architecture in our modern society (Langston, 2014). In 1972, Sir Alex Gordon, former president of the Royal Institute of British Architects (RIBA), argued that *good architecture* should be designed for loose fit, long life and low energy (Gordon, 1972). Today, Gordon's objectives, known as the 'three Ls', can be interpreted as durable, flexible and sustainable. A thorough consideration of these parameters' objectives and how they have so far been addressed in the literature has been discussed in Imam and Sinclair (2018 and 2020). Furthermore, Imam and Sinclair (2021) introduced *environmental, social, and economic* facets as an essential core to qualitatively define Agile Architecture. A design team can have all technical sustainability prerequisites in place—air-tight envelope, efficient HVAC systems, renewable energy generation, low VOC materials, etc.—yet the project can still fail the *test of time*. As a senior architect—survey respondent—puts it, "it is as if we have all the raw materials, but where is the fire?" The theories of sustainable architecture that we have been studying treat *flexibility, technology, and innovation* like a *black box*. Indeed, what we are missing is a *process* for converting the *raw materials* of future-proof design ideologies into real-world successes. Once a design team is committed to *designing for the future*, what should it do? What process should it use? How should it be held accountable to performance milestones? These are all questions the Agile methodology is designed to answer. The theoretical frame introduced in this paper is viewed as a medium to aid designers, developers, and policymakers—and by implication incorporated in the decision-making process—in applying and realizing greater project Agility.

2.0 SURVEY STUDY: HOW THE INDUSTRY PERCEIVES FLEXIBILITY

"...I am a strong believer that all the resources and technologies are available to create low energy/carbon buildings. It is as if we have all the raw materials, but where is the fire?" (Survey respondent: Architect, over ten years of experience in the AEC industry)

Sustainable design intervention is much more likely to be accepted if it considers how the stakeholders perceive and interpret high-performance buildings. From a psychological perspective, "a person's perception of how a system operates is often referred to as a *mental model*. This might come from educated understandings via literature and mentorships or simply from practical experimentation with the controls—and in both cases, their mental model might or might not be accurate" (Gabe, Walker and Verplanken, 2016). Within this context, the survey conducted here aimed to reveal the structure of participants' mental models regarding the *sustainable* and *flexible* building design processes.

2.1 Participants and design

The survey was aimed at three focus groups, namely, architects, researchers and policymakers. The literature suggests that these stakeholders are key influencers constantly affecting buildings' decision-making process. Despite the research efforts to recruit an equal number of participants in all focus groups—given that all participants hold equal value in formulating the framework—the practical realities of recruiting experienced participants led to challenges and proved to be more difficult than anticipated. The survey collected a total of 69 valid responses. Nonetheless, the survey resulted in big discrepancies between the three focus groups, with 73.9% (51) architects, 21.7% (15) researchers and 4.4% (3) policymakers. An online questionnaire was conducted to capture insights into current mindsets and practices regarding Agile architecture—the nature of questions concerned designers' approaches to Agility. The survey was distributed and administrated digitally via Qualtrics web-based platform, and answers were completely randomized. The questionnaire is structured using a pre-determined set of closed-ended questions, while select questions have an open-dialogue option for comments and further explanation.

2.2 Survey method

The survey adopted a nonprobability sampling method, namely, purposive sampling, where each potential subject had a known probability of being selected for the questionnaire (Robinson, 2014). The participants' selection method within the purposive category is *judgement sampling* (ibid), following a non-random sample selected based on a pre-identified set of requirements. By using minimum quotas, this strategy ensures that key groups are represented in the sample, thus avoiding any biased selection or conclusion. Participants were recruited using online open-source professional and academic networks (i.e., LinkedIn, Academia and Research Gate). An invitation email or post was circulated via direct contact (e.g., LinkedIn or Academia messages) or posting on relevant LinkedIn groups with at least 1000 members to approach an active and up-to-date audience. The invitation message included a brief description of the project and a link to an online questionnaire that participants could access from their computers. Key survey questions and insights are discussed below.

2.3 Results

Representation and beliefs about flexibility in architecture

Our initial questions probed respondents for their understanding of *sustainability* and *flexibility* in building design. Specifically, we asked architects how they understood "meaningful sustainability" and, within that context, *who* and *what* influences how buildings are designed for flexibility. Unsurprisingly, given the industry's prevailing discourse

around outlining sustainability solely in the frame of operational energy/carbon reduction, *operational energy consumption* was weighted as *first* in terms of its importance in creating meaningful sustainable building design, with 63.75% and 25.5% of architects granting it first and second places respectively. Furthermore, the role of "flexible building design" in establishing meaningful sustainability seems to be confused amongst participating architects. Participants' votes are scattered amid ranking levels, with no clear direction. Survey participants from researchers, however, ranked "*flexible building design*" in *second place* in terms of its significance in creating meaningful sustainable built environment. Moreover, we asked architects and researchers about encountered *sustainability resistance* and *barriers* in the market. "We are not in control," noted an architect with over ten years of experience in the AEC industry. This, in part, is due to the misalignment of incentives between stakeholders (i.e., circle of blame; see Imam and Sinclair, 2020).

Perceived benefits and limitations of current practices

Next, we explored participants' evaluations of *current design philosophies and guidance* for flexibility—as concluded by the literature review. Interestingly, when asked about design philosophies that impact long-term buildings' flexibility, holistic building layers approach along with durability (longevity) characteristics ranked first. However, participants' votes were scattered between the first four ranking levels, indicating a relatively confused direction regarding sound design philosophies that can impact buildings obsolesce. To interpret limitations of current practices, the survey asked participants to evaluate *design methods* and *parameters* in terms of their *practical implementation* to designing for flexibility. Participating architects considered *previous project precedents* as the main method they use to guide their designs for new projects. On the other hand, *user feedback* was weighted as the least relevant to inform the design process in a "real-world" setting. Though, it can be argued that the essence of *good design*—as defined by Sir Alex Gordon—is lost in such a disconnected design approach. How can we rely on *previous projects* with no *user feedback* to inform new designs? Following such a dilemma makes us utterly blind to the essence of designing for change, designing for Agility. Thus, the Agile framework allows constant feedback for re-evaluation, namely, the build-measure-learn loop (see Imam and Sinclair, 2020).

Perceived alternatives to current practices

In an industry obsessed with numbers—such as capital costs, immediate revenue potential, kilowatt-hours of operational energy, operational greenhouse gas intensity—we asked architects and researchers how to keep buildings relevant, alive, or flexible. To the authors' surprise, the majority of survey respondents did not suggest a quantitative practice as the solution (i.e., *tools to measure or quantify flexibility*); instead, nearly 75% of architects and 85% of researchers ranked *framework to guide collaborative design teams* as potentially having the greatest influence in better preparing the built environment to surviving the test of time. Also, *increased awareness among industry stakeholders* came as a close second on the architects' list of possible advocates for flexibility. Since the literature indicates that most flexible design approaches are based on the building layers idea, it was necessary to ask survey participants from architects and researchers if they would consider using Stewart Brand's building layers diagram in a workshop or meeting to facilitate a discussion around flexibility. For participants' convenience, the layers diagram was copied below the question. 70.6% of respondents from architects said "yes, I'd use it," while 15.7% said "yes, I'd use it, but I'd change it," and 11.8% said, "no, I wouldn't use it." On the other hand, 100% of respondents from researchers answered with "yes, I'd use it." Our data suggest that in order to encourage the adoption of new agile practices, techniques, or technologies, we may need to address bigger questions about what Agility is, why it is necessary, and means/methods to implement it, in order to be successful, and hence the significance of the present research.

3.0 CASE STUDIES: CURRENT PRACTICES

"Flexibility is not the exhaustive anticipation of all possible changes. Most changes are unpredictable. Flexibility is the creation of margin – excess capacity that enables different and even opposite interpretations and uses." Rem Koolhaas

There is still a lack of consensus as to what design criteria would best maximize the flexibility of existing and future buildings. Thus, we investigated the unifying principles of Agile architecture through analyzing contemporary applications to understand the unique factors required to develop long-term sustainable environments. The significance is that examining how existing buildings have adapted to change can arguably identify the key factors needed to develop new, improved Agile buildings.

3.1 Methods and strategy

Case studies are arguably to be the preferred strategy when "how or "why" questions are being posed and when the focus is on a contemporary phenomenon within a real-life context. In such a setting, the literature suggests the case study research strategy to be an *explanatory* one (Yin, 1981, p. 59; Yin, 2003, pp. 2, 5-10). Hartley (1994 and 2004) argues that data collection and analysis are "developed together in an iterative process," which allows for theory development to be grounded in empirical evidence (Hartley, 1994, p. 220; Hartley, 2004, p. 329). The data is then organized around the research hypotheses and key themes and questions. Finally, the data is examined to understand how far they fit or fail to fit the expected hypotheses (ibid). In other words, "data analysis entails a search for patterns in data" (Neuman, 1997, p. 426). Neuman elaborates that once a pattern is identified, it is interpreted in terms of a social theory or the setting in which it occurred and that the qualitative researcher moves from the *description* of a

historical event or social setting to a more *holistic interpretation* of its meaning. Thus, the goal of this study was to uncover patterns, determine meanings, construct conclusions, all of which are vital components to build the Agile theoretical framework. Figure 1 explains the rationale behind selecting the eight global case study buildings.

Having the case studies drawn from five global regions —USA, China, Europe, India and Africa—helps draw generalizable theories and conclusions to the residential building design industry. Also, the case studies include different building scales and typologies while showcasing different responses to various contexts and conditions (e.g., affordability, land size, original obsolete functional use). The residential projects studied in this research are listed in Figure 2. All cases were constructed or retrofitted during the 21st century and had been recognized for national, state, or regional architectural distinction. The present research introduced these intriguing projects through in-depth analyses with Agility and sustainability front of mind and aimed to learn from the success and failure of each project. The qualitative method introduced avoids any set position or assumptions and instead critically evaluates each project objectively in the context of *durability*, *flexibility*, and *sustainability*. Case studies data, in tandem with the strategic literature review, highlights leading themes, ideas and practices for Agile architecture.

3.2 Identifying design patterns for Agility

The basis of analysis leading to the identified design patterns (illustrated in Figure 4 and reflected in the *Agile Design Toolkit*) was three-fold. 1) desk-based studies, 2) empirical observations, 3) applicability evaluations to the wider residential typography. From the empirical observations, several distinctive characteristics and properties of Agility constructs were extracted and organized in a list of interrelated applications/patterns. This list was then categorized into observed patterns, design limitations, or design gaps. For example, suppose an item repeatedly highlighted in the literature and deemed important in the survey study yet was not observed as a case study pattern. In that case, it is regarded as a gap (if deliberately overlooked) or a limitation (if certain boundaries prevented its implementation). Each pattern was then discussed and reorganized in a hierarchy relating to the theoretical perspective on Agility's physical, functional, and performance constructs. From the original twenty-eight (28) design patterns identified, ten (10) patterns (recognized as limitations or gaps) were identified as key deficiencies in the marketplace, and contextual barriers against formulating/implementing the Agile design framework—or any attempt to design for future performance and use. Thus, the proposed Agility framework attempts to bridge this gap of misalignment by building on and organizing the benefits of long-term sustainable buildings—in the context of the identified patterns and the associated theoretical labelled hierarchy highlighted in Figure 4—which is accounted for within the processes of design, construction, operation, and reuse.

The identified patterns and theoretical hierarchy can help formulate a framework for strategic design advice that can be used at the very beginning of a project's life. The Agile framework—discussed in the following pages—has the potential to assist in the transformation of the building industry towards more lifelong sustainable practices and help mitigate the effects of a changing climate. Providing a means by which the industry can design new buildings that have a high potential for *adaptive reuse* much later in their lives will clearly assist this endeavour.

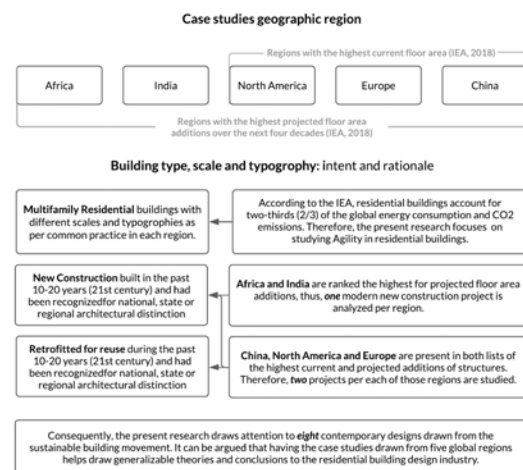

Figure 1. The rationale behind selecting the eight global case study buildings studied in the present research.

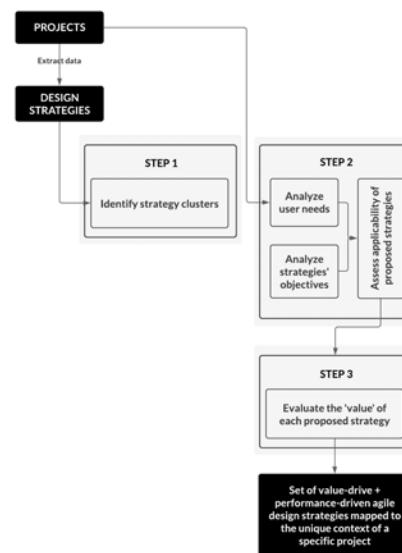

Figure 3. Model of Three-Step Data-Analysis Framework.

Figure 2. Selected contemporary case studies. From left (top) to the right (bottom): PATCH 22 (Amsterdam), Stacked student housing (India), 10x10 affordable housing (South Africa), 222 Jackson Avenue (USA), Yuntai apartment complex (China), Beton student housing (UK), Xizhimen apartments (China), Tiny tower (USA)

4.0 AGILE DESIGN TOOLKIT

"Because of different rates of change of its components, a building is always tearing itself apart." (Brand, 1994)

"The Agile design framework consists of two parts, 1) *Design Toolkit*, and 2) Mechanisms, Plans, and Procedures to inform *Policy*. The present paper introduces the Design Toolkit (see Imam and Sinclair 2021 for the proposed policy roadmap). The design toolkit is a three-step process illustrating the evaluation method, as shown in Figure 3.

4.1 STEP 1: Identification of Agile Design Clusters

The first step in the *Toolkit* groups the design strategies into clusters that display common characteristics (means of achieving flexibility, durability, and sustainability *via Agile Principles* and *Design Approaches*). Clusters are identified among design strategies by agile principles, design approaches, and change enabled (visualized in the Agile design framework Interactive; see Figure 5 for an explanatory snapshot). Each cluster includes a set of *design approaches* and strategies identified through three sequential stages: literature meta-analysis, survey of experts, and case studies. Analysis of each cluster provides information about the effectiveness, feasibility, and value of proposed strategies.

4.2 STEP 2: Assess the effectiveness of Agile strategies

The two subsequent steps in the *Toolkit* reflect the expected decision-making process for selecting a design strategy for a particular project. Next, a building user's needs are examined and classified, and design alternatives (*Step 1: Design Clusters*) are considered that would fulfill the user's needs.

Interactions within and among systems: The relationship is nonlinear

A key element in the present research is the definition and analysis of a building as *layers of systems and subsystems, which interact with one another*. Evidently, systems do not necessarily interact hierarchically, nor do they interact in a single pattern. Thus, these interactions must be thoroughly examined in a project-by-project evaluation framework. The general systems of a building are divided into four general categories, namely, structure, enclosure, services, and interior finish. Each category of systems can be further divided into subsystems. Slaughter (1997) concluded group system interactions into three general categories: *physical interaction, functional interaction, and spatial interaction*. *Physical interactions* among building systems can be through a connection, intersection, or adjacency. A roof element, for instance, can be mechanically connected to the structure, inserted through the structural elements, or simply rest upon the structure. Systems can *interact functionally* in ways that enhance, complement, or disintegrate current functions. For example, an exterior wall can provide additional shear capacity to a structural framing system; operable windows can complement a ventilation system, but if poorly incorporated, can sacrifice the performance of heating or cooling systems. Finally, *spatial interactions* occur when systems operate independently within a particular spatial region or space. For instance, lighting within a room spatially interacts in various ways with different interior surface finishes. While such systems are not physically or functionally interrelating, their spatial interaction may be crucial for the owner's perception of the space (Slaughter, 2001).

Change types reimagined: Allowing designs to co-evolve with their environment

A building system can be expected to experience different types of changes throughout its lifetime: *changes in function, changes in capacity, and changes in flow*, each of which can be further partitioned into more specific changes. The present research expands on Maury's (1999) types of change to capture what the authors view as necessities of the 21st century. *Changes in function* occur to achieve specific objectives: 1) upgrading existing functions, 2) incorporating new functions to achieve new objectives, and 3) modifying to accommodate changes in usage class or alter the function of the building entirely. *Changes in capacity* relate to a facility's ability to meet certain performance requirements (e.g., prescriptive assembly requirements for higher efficiency) and include 1) changes in loads or conditions, 2) increase and/or decrease in overall building volume, and 3) performance-driven design and thermal resilience. *Changes in flow* refer to the movements within and around a building and can relate to 1) environmental flows, such as heating, cooling, and ventilation, and 2) the flow of people or objects around or through a building space. While these change types do not describe in detail the specific changes, a building undergoes, most specific changes can be classified into one of these general types.

Expecting user needs: Display emergent properties

User needs can be defined in a matrix form as the intersections of *building subsystems* and the *change types*. The horizontal axis of this matrix should delineate the building systems and subsystems, and the vertical axis should list the *eight general change types* defined earlier. The present research classifies user needs according to three timeframe categories: Short-term (1-5 years), medium-term (5-15 years), and long-term (15-30 years). *Short-term* needs are common, clearly defined, and likely to be forecasted at the time of initial construction. *Long-term* needs are often large changes (e.g., a change in usage class) and can be more uncertain and difficult to forecast accurately early in the construction process. *Medium-term* needs have characteristics that fall between the short and long-term needs and are often tracked to predicted technological advancements. The level of Agility achieved by a design strategy is assumed to be constant with time (i.e., strategies have the capacity to accommodate change at an indefinite time change – in the short, medium, or long-term). Because of the interactions between systems, some strategies may require changes to the design and/or construction of another system or subsystems. For example, a building's ventilation system could

use the plenum beneath a raised access floor to distribute air rather than use conventional steel ducts, allowing ventilation patterns to change by simply adding or moving floor panels containing vents. While the strategy provides flexibility to the heating, ventilation, and air conditioning subsystems (within the services system), implementing the design strategy requires changes to the finish system. To capture these factors in the analysis, the design team should use the proposed *matrix* (the intersections of building subsystems and the change types) multiple times (i.e., repeat matrix table per building system to separate the subsystems undergoing a design change from the subsystems receiving added flexibility).

4.3 STEP 3: Assess the value of Agility

The benefits of agile design strategies can be in many forms: reduced financial costs, shortened construction schedule and/or downtime, climate resilience, thermal comfort, avoided premature functional or physical obsolescence. These costs and benefits are intended to be realized by different parties in the construction process, which likely occur at different milestones during the life of the building. Thus, the present research identifies three timeframe categories: initial design and construction, operations and maintenance, and change implementation. These timeframes help describe the distinct types of construction activities that occur in the life of a building. The only clearly quantifiable measure used is an order of magnitude estimate of the cost, as compared to conventional techniques. Since cost estimates performed by contractors may vary widely depending on their capabilities, geographic location, and current construction market, estimates to determine the specific cost should be evaluated on a project-by-project basis. For design strategies that are considered overly complex by the design team, the costs cannot be accurately estimated using currently available techniques in the literature. This, however, urges the necessity to develop a novel construction process simulation software. Financial costs for the operations and maintenance (O&M). Phases are often not documented by building owners and managers, yet another obvious limitation to overcome through future research. Instead, costs are judged to likely increase or decrease based on the extent and type of new O&M activities required for systems affected by a design strategy, as compared to systems of conventional designs. To lend a level of repeatability to the "less quantifiable" measurement, the present research suggests describing measures in terms of explicit criteria. For example, procurement concerns are classified as either 'yes' or 'no' depending on whether unconventional materials are required, based on the assumption that specialty materials will be more difficult to procure than conventional materials.

5.0 A CONCLUSION AND A BEGINNING

This brings us back to our initial question: How do we design for time? From the authors' perspective, technical feasibility alone does not accomplish an agile solution. The concepts and means of Agility discussed in this paper bring an emphasis on process and enabling the building to 'learn' and the users to 'teach' or shape the space themselves. Agility aims for the design to become an ongoing social process between the designer, user, and community within. The designer is responsible for enabling durability, flexibility, and sustainability to take place, as opposed to attempting to control experiences and anticipate the future. In reality, architecture is placed inside a rather unpredictable context where it is forced to respond to and act on exogenous demands or suffer premature obsolescence. It is here where good design takes place through the conscious understanding and negotiations of these demands towards synthesized solutions which recognize the dynamic nature of the context in which the building exists and will continually evolve with time.

We view Agility as a design principle that brings time and change to the forefront of thought but requires a reconceptualization of time through shifting mindsets and unifying of values. That said, placing architecture in context may suggest to under design rather than over design, to leave space unfinished as a mechanism for engagement. The unprecedented consequences of COVID-19 and climate change mark what the authors see as the beginning of the end of traditional architecture and urban design as we know it. Incongruously, almost every traditional AEC organization, while trying to figure out its place in this changing world, is stubbornly trying to build a bulwark to protect old models that can't possibly survive the sea of change underway. Thus, from the authors' perspective, if change is the new problem; Agility is the new solution.

RESILIENT CITY
Physical, Social, and Economic Perspectives

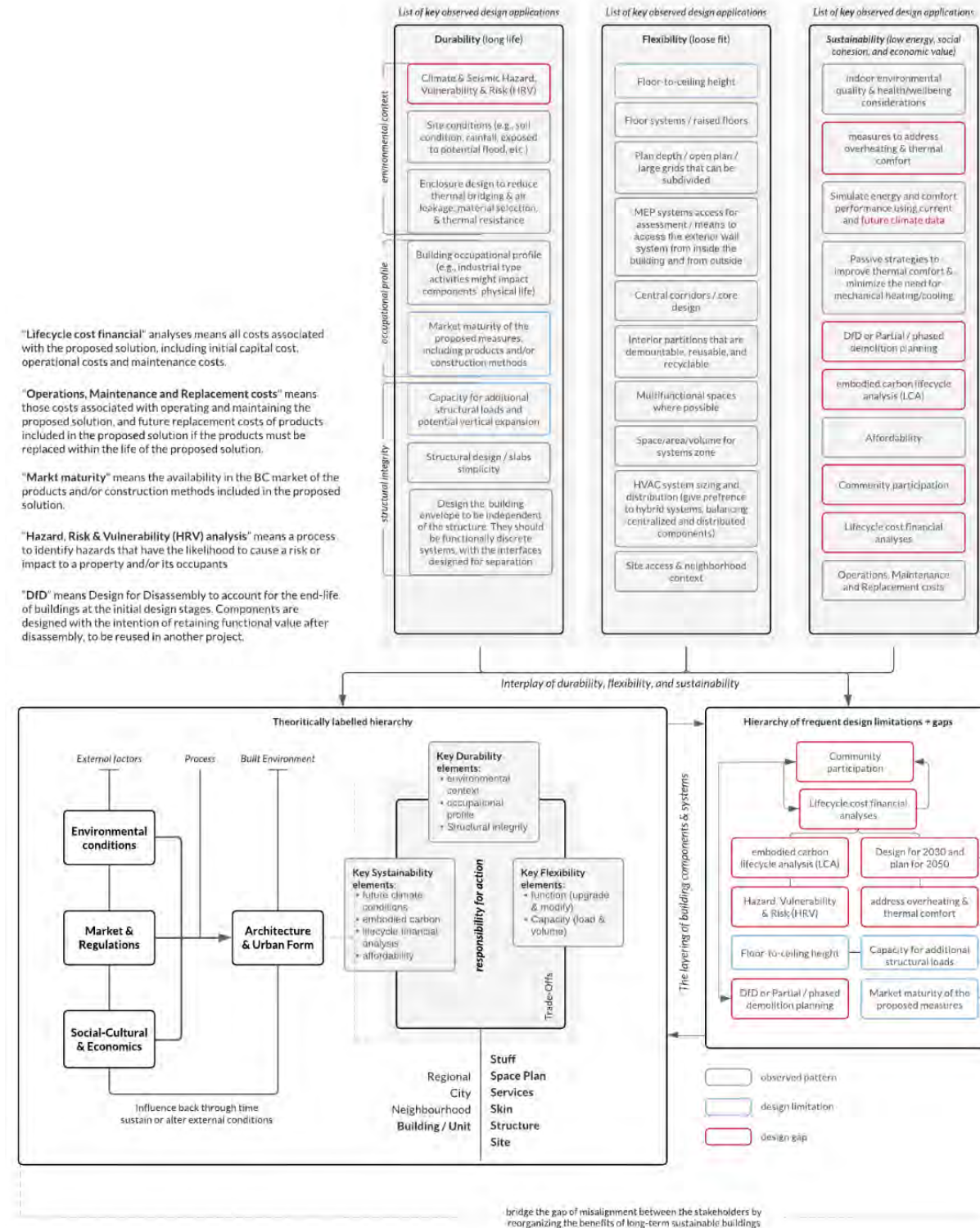

Figure 4. Identified patterns for Agile design through case study analysis.

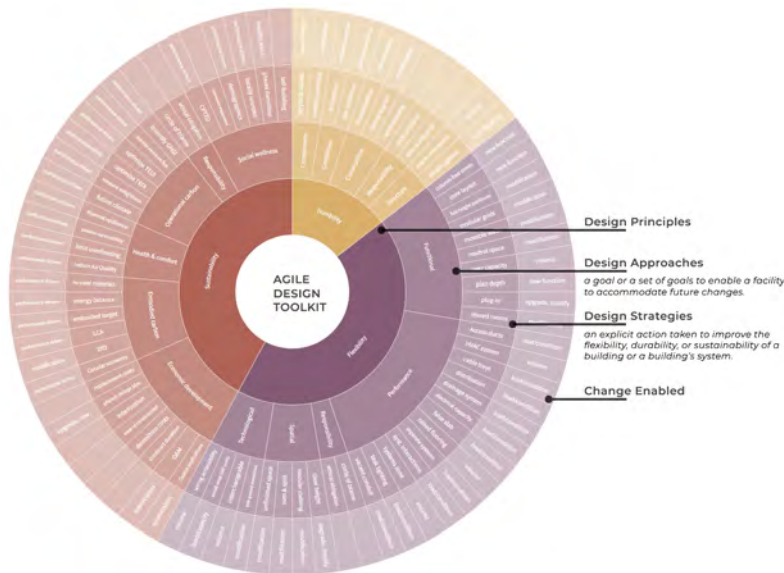

Figure 5. Explanatory snapshot of the Agile Design Toolkit Interactive. The Toolkit should not be used in isolation to this paper.

REFERENCES

- Gabe-Thomas, E., Walker, I. and Verplanken, B., 2016. Householders' Mental Models of Domestic Energy Consumption: Using a Sort-And-Cluster Method to Identify Shared Concepts of Appliance Similarity. *PLoS ONE*, 11(7).
- Gordon, A., 1972. Designing for survival: the President introduces his long life/loose fit/low energy study. *Royal Institute of British Architects Journal*, 79(9), pp. 374-376.
- Hartley, J., 1994. Case studies in organizational research. In: C. C. & G. S. (Eds.), ed. *Qualitative methods in organizational research, a practical guide*. London: Sage, pp. 208-229.
- Hartley, J., 2004. Case study research. In: C. C. & G. S. (Eds.), ed. *Essential guide to qualitative methods in organizational research*. London: Sage, pp. 323-333.
- Imam, S. and Sinclair, B., 2018. Dysfunctional Design + Construction: A Cohesive Frame To Advance Agility + Sustainability. Philadelphia, ARCC-EAAE International Conference, pp. 415-423.
- Imam, S. and Sinclair, B., 2020. Designed to change: The future of architecture is Agile. Valencia, Spain, EAAE-ARCC INTERNATIONAL CONFERENCE & 2nd VIBRArch.
- Imam, S. and Sinclair, B., 2021. New Reality. New Architecture.. TUCSON, ARCC 2021 International Conference: PERFORMATIVE ENVIRONMENTS.
- Kronenburg, R., 2007. *Flexible: Architecture that Responds to Change*. 1st edition ed. London: Lawrence King Publishing.
- Langston, C., 2014. Measuring Good Architecture: Long life, loose fit, low energy. *European Journal of Sustainable Development*, 3(4), pp. 163-174.
- Neuman, L. W., 1997. *Social research methods, qualitative and quantitative approaches*. 3rd ed. ed. Boston: Allyn and Bacon.
- Richter, U. L. A., 2005. *The adaptable tall building*, Leipzig: LACER No 5.
- Robinson, O. C., 2014. Sampling in Interview-Based Qualitative Research: A Theoretical and Practical Guide. *Qualitative Research in Psychology*, Volume 11, pp. 25-41.
- Rogers, R., 1998. *Cities for a small planet*. London: Faber and Faber.
- Sinclair, B., 2012. *Contemplating Change | Executing Transformation: Psychological Constructs + Behavioral Considerations in the Pursuit of Open Building*. Beijing, CIB W104, pp. 211-220.
- Sinclair, B., 2015. Integration | Innovation | Inclusion: Values, Variables and the Design of Human Environments. *Cybernetics and Systems*, 46(6-7), pp. 554-579.
- Till, J. and Schneider, T., 2007. *Flexible Housing*. First ed. Burlington: Elsevier.
- Weston, R., 1996. *Modernism*. 1st edition ed. London: Phaidon Press.
- Weston, R., 2011. *100 Ideas that Changed Architecture*. First published January 1st 2005 ed. London: Lawrence King Publishing Ltd.
- Yin, R. K., 1981. The case study crisis: Some answers. *Administrative Science Quarterly*, 26(1), pp. 58-65.
- Yin, R. K., 2003. *Case study research, design and methods*. 3rd ed., vol. 5 ed. s.l.: Thousand Oaks: Sage.

From Cold War to Global Warming: Dilemma's in Retrofitting the Modernist University Campus in Latin America. Case Study: Escuela Politécnica Nacional (EPN) in Quito, Ecuador

Victor H. Molina^{1,2}

¹Delft University of Technology, Delft, The Netherlands

²Universidad Técnica de Ambato, Ambato, Ecuador

ABSTRACT: During the Cold War the Americas experienced population growth that demanded higher education facilities, amongst other social requirements. Latin America attempted to meet the demands of a fast-growing student population by adopting/adapting the North American campus model. It was a time when natural resources were considered endless, and sustainability was far from being a social concern. However, environmental concerns such as climate change are currently driving university administrators and estate managers to re-think how university campus -designed under the modern architecture paradigm- should be retrofitted and upgraded, to respond to the main challenge of our generation. Natural, human, economic and technical resources can be used more effectively by universities, not only to make campuses appropriate settings to promote sustainability values and sustainable lifestyles in the academic communities, but also for becoming a referent in the city where the campus is hosted. In this study emblematic buildings of a university campus in Quito are taken as an example to explore the potentials and pitfalls in setting out a resilient development strategy. The research method is case study and the methodology design is based on an adaptation of Hunt & Boyd (2017) 'Fit for the future' criteria for retrofitting existing buildings towards new uses or achieving sustainability goals. The study attempts to find out to what extend 'Fit for the future' criteria is applicable in modern buildings towards sustainable adaptation to climate change challenges. Even though the sustainability concept has been already included in local and institutional policy, other factors such as location, organizational attributes, political structure, and communication strategies might affect universities' response to climate change.

KEYWORDS: Climate change, university campus, building retrofit.

INTRODUCTION

Latin America experienced accelerated social and economic transformations for almost fifty years, thanks to the demand for agricultural products and raw materials in global markets from the 1930s until the neoliberal crisis of the 1980s. Along with economic affluence, the processes of population growth and accelerated urbanization took place in most Latin American countries. To cope with the needs of society, universities increased academic offers an enlarged campus facilities to host an increasing student population (Rama and Tedesco 1979). Amongst the most remarkable examples of modern university cities and campuses in Latin America are Universidad Nacional Autónoma de México (UNAM); Universidad Central de Venezuela, in Caracas, Venezuela; and Universidade Federal de Minas Gerais (UFMG) in Belo Horizonte, Brazil; but also including Escuela Politécnica Nacional (EPN) in Quito, Ecuador.

1.0 UNIVERSITY CITIES IN LATIN AMERICA DURING THE COLD WAR PERIOD

1.1 Higher education as a regional development strategy.

During the Cold War period, higher education in general and the construction of university campuses in Latin American was seen as a response to the dependency theory, therefore, as a strategy to strengthen regional development processes. Nowadays, universities in Latin America -as well in the rest of the world- and particularly their university cities and campuses are being expected to become referential sites for facing sustainability challenges -including climate change- by improving their environmental footprint "both in campus operations (estate management, procurement, etc.), and in teaching, research, and public impact," (Sonetti, Brown & Naboni 2019, 11).

The first internationally renowned example of a university campus as a development strategy was the master plan of Universidad Nacional Autónoma de México (UNAM) designed and built between 1949 and 1952 by Mario Pani, Enrique del Moral and Mauricio Campos. Within the UNAM campus, the Central Library is one of the most iconic facilities, particularly because of the mural designed by Juan O'Gorman that encloses the upper ten floors of the building (UNESCO 2007), representing the history of Mexico's aboriginal and colonial culture (Noelle 2016). The portrayal of murals on modern building facades at UNAM has been depicted by Castañeda (2016) as *the use of architecture as a*

political act. Just upon its inauguration in 1952, the UNAM campus was selected as the venue for the Pan American Congress of Architects held in México. Frank L. Wright, Walter Gropius, Richard Neutra and Carlos Raúl Villanueva were amongst the 'guests of honour of the event that included guided walk-throughs on campus (Levi 1952, November 2; Graciavelez 2014). As reported by Julian Levy:

"The site of the Congress -- the new University City about 12 miles out from the center of Mexico City -- provided an exciting and unique setting. In this short memo it is impossible to do justice to its conception, plan, use of materials and of color. The many architects involved worked as a huge team. They said, "it is the labor of Mexican architects working for Mexico." In spite of their desire for anonymity, they all are full of praise for Carlos Lazo, who headed the group and was the president of the Congress. This was particularly gratifying to me for Lazo came to the U.S. some 10 years ago on the Delano and Aldrich Fellowship. His travels and studies here, added to his native ability, have been justified by his meteoric career" (Levi 1952, November 2).

In this regional context, the university campus of Escuela Politécnica Nacional (EPN) becomes one of the most relevant examples of the development strategy through higher education in South America, and particularly in Quito, Ecuador. EPN campus was designed in the 1960s, during the time Ecuador was experiencing accelerated economic growth due to increasing international trade and the need of improving human capital for supporting industrialization processes at the national level. The campus master plan was designed by Mario Arias, and the most iconic buildings -the School of Mechanical Engineering and Administrative bldg.- were designed by Oswaldo de la Torre. Both, Arias and de la Torre not long before graduated from the first cohort of the School of Architecture and Urban Planning in Universidad Central del Ecuador.

Prior to his commissioning at EPN, Oswaldo de la Torre had the opportunity to travel to the United States of America from 1957 to 1958. While in the US he visited four practices related to the construction industry: Rader and Associates in Miami, Florida; Smith Engineering and Construction Co. in Pensacola, Florida; Tippetts, Abbott, McCarthy & Stratton in New York City, New York; and William, Cole, Blanchard, and Associates in Washington D.C. (Saltos & Sánchez 2010). When De la Torre returned to Ecuador, in 1960, he was put in charge of the construction of Hotel InterContinental in Quito, designed by renowned US architect Charles Foster McKirahan (Compte 2021, Mach 24) in post-war Miami Modern 'MiMo' architectural style (The City of Miami Beach Planning Department, 2018) for the US-based Pan Am Corporation (Inter-Continental Hotels & Resorts 2021; IHG Hotels & Resorts 2021). The Hotel InterContinental Quito was meant to be in the 1960s the main venue for hosting head of states and diplomatic delegations for the Eleventh Inter-American Conference, which never took place (Reid 1968).



Figure 1: Hotel InterContinental Quito, designed by renowned US architect Charles Foster McKirahan, built by Oswaldo de la Torre. Source: Author.

1.2 Facing Climate Change in Quito, Ecuador: challenges to Escuela Politécnica Nacional (EPN).

Nowadays university campuses in Latin America, including UNAM, UCV, UFMG, and EPN, are facing both the need for upgrading and retrofitting their university campuses due to technological and demographic changes, as well as the challenge of facing climate change and embracing sustainability values.

Particularly, in Quito, where the university campus of Escuela Politécnica Nacional (EPN) is located, the impact of climate change has been reported by Barros and Troncoso (2010) and Yates, Flores-Lopez, Estacio, Depsky, Metha and Tehelen (2013) in a collaborative study of the Ecuadorian National Center for Atmospheric Research and the Stockholm Environment Institute (SEI) for the municipality of the Distrito Metropolitano de Quito (DMQ); the findings of both studies are reflected in the DMQ Climate Action Plan, showing climate variation in a hundred years with a tendency to the increase of the average annual temperature, raising from 10.8 °C in 1905 to 12 °C in 2005, equivalent to 1.2 °C in one century (Arias 2017).

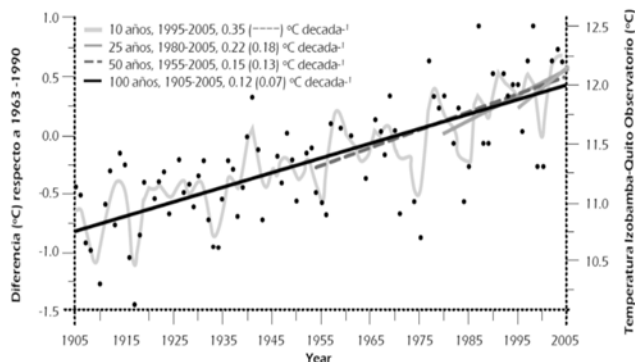

Figure 2: Average temperature variation in Quito 1905-2005. Source: (Arias 2017)

Also, the perception of Quito inhabitants is that climate patterns have changed; and, either heat during the summer or cold during the winter, temperatures are going to the extremes. A similar perception of change is reported regarding patterns of rainfall, wind speed, and solar radiation (Yates et al 2013). For instance, what Escuela Politécnica Nacional (EPN) is facing in its university campus in Quito, might be similar to the case of other universities in the region as well as worldwide. Hence, an OECD report from 2012 advised university administrators and estate managers to first consider adapting existing structures to current challenges before building new ones:

"Place independency: due to developments in ICT, people can work wherever is best for them; [and] new life for old heritage buildings: value old premises instead of necessarily building new ones. This is also linked to sustainability goals and the trade-off between quantity and quality of space" (Den Heijer 2012, 3).

An argument to be considered during the retrofitting of university campuses, or the design of new ones.

2.0 GOALS AND OBJECTIVE, RESEARCH QUESTION AND RELEVANCE OF THE RESEARCH

2.1. Goals and objectives.

The study attempts to explore strategies towards the adaptation of the university campus of Escuela Politécnica Nacional (EPN) -designed during the Cold War period- and particularly two of its more emblematic buildings – the School of Mechanical Engineering (SME Bldg.) from 1964 and the Administration building (ADM Bldg.) from 1965- designed by modern Ecuadorian architect Oswaldo de la Torre, towards facing the challenges of climate change and sustainability. The objective is to identify key strategic considerations when potentially retrofitting two modern historical facilities of Escuela Politécnica Nacional (EPN) in Quito, Ecuador.

2.2. Research Question

What are the key considerations -from the architectural and from the engineering point of view- the SME Bldg. (1964) and the ADM Bldg. (1965), located at EPN university campus in Quito, Ecuador- during the process of adapting/upgrading those buildings to sustainability demands? The rationale for selecting the case study is primarily because those buildings, designed by Oswaldo de la Torre, are identified as one of the most iconic buildings within EPN university campus, but also as emblematic examples of modern architecture in Ecuador (Saltos & Sánchez 2010).

2.3. Relevance

The relevance of analyzing the SME Bldg. (1964) and the ADM Bldg. (1965), located at EPN university campus in Quito, Ecuador lies in the fact that natural, human, economic and technical resources can be used more effectively by universities in the region not only to make campuses appropriate settings to promote sustainability values and sustainable lifestyles in the academic communities but also for becoming a referent in the city where the campus is hosted. The potential of university campuses for becoming a living lab where sustainability issues are addressed brings hope that learned lessons and best practices could be shared with other universities in the Latin American region.

3.0 CONSERVATION OF MODERN ARCHITECTURE AND RATIONALE FOR RETROFITTING MODERN BUILDINGS TOWARDS SUSTAINABILITY PRINCIPLE: A LITERATURE REVIEW.

3.1. Conservation of Modern Architecture.

In the 20th century, the Venice Charter of 1964 is pointed out as the foundational stone of architectural conservation. However, it is ten years earlier, in 1954, that the Hague Convention for the Protection of Cultural Property in the Event of Armed Conflict was established by UNESCO. The Hague Convention was promoted because of the destruction of historical buildings during World War II, and to prevent similar actions in the future (Zografos 2019; Grignolo 2018). Additionally, rapid industrialization processes and the real estate market are putting more pressure on the disposal and replacement of modern buildings with newer facilities. Ironically, the modern architecture movement,

"[I]n an attempt to establish a new architectural language freed from the past, disregarded anything that dealt with historic buildings and their conservation" (Zografos 2019, 60).

However, nowadays some modern might be considered an object of conservation. The debate will be widely enriched since modern architecture buildings have been included in the historical heritage listing. Buildings from the postwar period -the 1950s and onwards- usually have incorporated 'hidden' mechanical systems whose conservation would be critical if an integral approach to restoration is taken, according to Chalifoux (2019). One of the leading initiatives in the field is driven by The Getty Conservation Institute (MacDonald, Burke, & Lardinois 2018). Also, it is important to consider that 'while many modern buildings from the postwar era were created at a time when society was still mainly industrial, they are now being used in a predominately post-industrial world' (Normandin 2018, 42). Furthermore, due to the pressures of climate change, urgent actions must be taken by the community of practitioners,

"[T]hat deal with the built environment, (...), to apply standards and regulations for the conservation of buildings and sites in the context of new climate realities, (...), mitigate impacts from severe wear upon historic places (...), and adapt our built heritage to new climate-disaster realities." (Brandt & Rouillard 2020, 37-38).

Regarding modern architectural heritage, Elefante (2017, 11) argues that

"Buildings constructed between 1950 and 2000 comprise two-thirds of the current building stock in the U.S. Many are the worst energy hogs ever constructed. While green-building practitioners may have solutions for achieving Paris Accord targets through the design of new buildings, very few have even begun to recognize the importance of mid-century buildings."

In this context, the role of the built environment professionals is critical to meet not only the above-mentioned challenges but also others related to a more contemporary concern such as climate change.

3.2. Rationale for retrofitting modern buildings towards sustainability principles

While Hunt & Boyd (2017) argue the need for periodical retrofitting in buildings, when stating that

"Buildings are constantly evolving. Daily use, subtle movement, alterations, or additions, coupled with the patination and decay of surfaces through wear and weather, are all part of this process. For a building to occupy its future place successfully, each of these elements must be considered alongside the needs of today." (Hunt & Boyd 2017, 135).

The need for incorporating mechanical systems and ICT Infrastructure in the retrofitting historical buildings, is particularly explained by Zografos (2019):

"Change in architecture, as in life, is an inevitable fact. When the occupants of a building are not satisfied with it, they tend to move. If a building's efficiency is compromised, certain measures are implemented to adjust it to higher standards." (Zografos 2019, 62).

Regarding the case study, applied research related to climate change and the built environment in Ecuador has been recently published by Acosta (2020), and regarding sustainability and climate change by Pérez-Pérez (2020). The latter portraying a timeline of Ecuadorian sustainability public policy, from 1992 to 2013, including one in energy efficiency and other in the use of renewable energy in buildings.

In conclusion, the conservation of modern architectural buildings is currently confluent with the retrofitting of those buildings under the principles of sustainability (Hunt & Boyd 2017; Zografos 2019). This confluence is particularly stressed because modern architecture was built in a time when the very concept of sustainability was not considered in public policy related to the built environment and the construction industry (Pérez-Pérez 2020), but nowadays it is an unavoidable consideration in retrofitting either for complying with current regulations or to meet the expectations of the public and the community.

4.0 CASE STUDY: ESCUELA POLITÉCNICA NACIONAL (EPN) IN QUITO, ECUADOR.

4.1. Method.

The method is case study. The selected case are the Administrative Bldg. and the School of Mechanical Engineering Bldg. located in the National Polytechnic School campus in Quito, Ecuador.

4.2. Methodology design.

The methodology is primarily based on qualitative analysis and expert opinion applied to an adaptation of 'Fit for the future' developed by Hunt & Boyd (2017), which is a theoretical approach to sustainable building retrofit, towards new uses or towards achieving sustainability goals, as claimed:

"[I]mproving the resilience of historic buildings, energy efficiency, flood defenses, overheating and indoor air quality rank high among the issues to consider but must be matched by a determination to maintain the vital qualities that make old buildings special." (Hunt & Boyd, 2017, p. 135).

For the purpose of this research of Hunt & Boyd (2017) theoretical approach will be called 'Fit for the Future: Addressing Sustainability's Criteria; including the following: accessibility, lighting, and services. Also, for addressing sustainability, energy efficiency, daylight, ventilation, energy generation, flooding, and maintenance are considered.

5.0 CASE STUDY: ESCUELA POLITÉCNICA NACIONAL (EPN) IN QUITO, ECUADOR.

To illustrate, the 'Fit for the Future' criteria will be applied to both the Administrative Bldg. and the School of Mechanical Engineering Bldg. located in the National Polytechnic School campus in Quito, Ecuador. Analysis and conclusion will be drawn from the case study.

5.1. The modern campus of Escuela Politécnica Nacional (EPN) in La Floresta.

National Polytechnic School (EPN by its acronym in Spanish) is an Ecuadorian public university created by President García Moreno on August 27, 1869. EPN was devoted to educating civil engineers and architects amongst other degrees. Although EPN became a key institution in the Ecuadorian higher education system at that time, it was dissolved into the Universidad Central del Ecuador in 1935 -during the first presidential term of Velasco Ibarra- mainly due to political motivations (Espinosa 2011); a decade later, on February 8, 1945 Velasco Ibarra -now in his second presidential term- reopened EPN “as an intuitive response to the expansion of international markets after the Second World War” (Espinosa, 2011, 73). Alberto Semenate -educated in Europe and in the United States of America- was named head of the re-opened school. During his term, and thanks to a direct request from Ecuadorian president Velasco Ibarra to French president Charles de Gaulle, six French researchers arrived in Quito as visiting professors, including renowned scientist Robert Hoffstetter who stayed in Quito for more than a decade -1946 to 1953- becoming a leading researcher at EPN in the fields of zoology and paleobiogeography (Espinosa 2011; Bull. Inst. Fr. Études andines 2000). By the year 1959, Jaime Chávez -who succeeded Semenate as head of EPN- promoted the design and construction of the new university campus at the northeast fringe of Quito, in La Floresta neighborhood (Espinosa 2011). However, it was not until the 1960s -during the first term of the succeeding EPN president Rubén Orellana- that the new buildings broke ground on campus.

5.2. Modern buildings for a modern campus.

Rubén Orellana commissioned the design of the School of Civil and Industrial Engineering (1961), the School of Hydraulics and the Hydraulics Research Institute, the School of Mechanical Engineering (1964), the Administration bldg. (1965), the Graduate Program of Industrial Engineering bldg. (1965); the Technology Research Institute bldg. (1966); and the School of Computer Technology bldg. (1977) to local architects. Also, during the uninterrupted 30 years of consecutive presidential terms, Orellana managed to build most of the planned academic facilities. (Espinosa 2011). The architectural design and construction of both the School of Mechanical Engineering (SME Bldg.) in 1964, and the Administrative Building (ADM Bldg.) in 1965 was trusted by Rubén Orellana to Oswaldo de la Torre (Saltos & Sánchez 2010). Interestingly, both the School of Mechanical Engineering (figure 4B) and the Administration bldg. (figure 4C) at EPN campus, designed and built by De la Torre, are arguably fortress shaped, quite opposed to Hotel InterContinental Quito designed by McKirahan and built by de la Torre in a prior commission.

The School of Mechanical Engineering, 1964, is a four-story building where the sense of a fortress is stressed by the metallic outer skin. The building’s outer skin is a regular and repetitive composition of 3 by 32 framed vertical rectangles that entirely cover the three upper floors on both east and west sides of the building, preventing sunlight from overheating classrooms, laboratories, and administrative offices; a particularly smart decision for a city like Quito, located in latitude 0°, and in the country region with the higher level of average sun irradiation per year.



Figure 3. Escuela Politécnica Nacional (EPN), School of Mechanical Engineering, designed by Oswaldo de la Torre.
Source: Saltos & Sánchez, 2010.

The Administration bldg. -which also served as a classroom building in the early years of EPN’s La Floresta campus-, is a twelve (12) story building that portrait a fortress-shaped façade as well. However, in this case, it is not an outer skin added to the structure, but the concrete structure itself. Additionally, the façade is divided into two sections by a central feature that holds the stairs. Each section is an irregular matrix of seven by twelve vertical windows with alternated sequences that prevent the façade to look repetitive, even more, when sunlight created a wide variety of shadows. As in the School of Mechanical Engineering, de la Torre designs thinking in avoiding overheating by sunlight in the facility.



Figure 4. Escuela Politécnica Nacional (EPN). Administration Building (tall building in the back), designed by Oswaldo de la Torre. Source: Saltos & Sánchez 2010.

Floor plans, technical drawings, and additional images of both the School of Mechanical Engineering-SME and the Administration Building-ADM included on Annex 1 thanks to Saltos, X. & Sánchez, H. (2010) in a compilation of modern architecture in Ecuador edited by María A. Hermida and published by Universidad de Cuenca.

5.3. Old-modern buildings in the old-modern campus of Escuela Politécnica Nacional (EPN) in La Floresta.

A half-century after the opening of the university campus of Escuela Politécnica Nacional (EPN) in the Floresta neighbourhood, buildings designed by de la Torre stand in good shape, despite the fact there have been several shakes and earthquakes in Quito during the period of analysis. Furthermore, both buildings have been able to preserve intact their morphology despite small interventions to respond to transitory needs in academia, if it fits within what Hunt & Boyd (2017) suggest:

"The goal for those living and working with old buildings must be to create and maintain structures and places that are accessible, enjoyable, comfortable and sustainable. In fulfilling these aims, challenges and dilemmas abound. Traditional skills and materials should be cherished and embraced but new technology and thinking must not be discounted" (p. 135)

However, to prevent them from detrimental interventions or neglected maintenance, EPN administrators have filed a request in the Heritage Department of the municipality of Quito (DMQ), for some of its buildings to be included in the modern heritage listing (Instituto Nacional de Patrimonio Cultural 2019a, 2019b, 2020; Ministerio de Cultura y Patrimonio, 2020). This request includes other buildings in the Floresta neighbourhood and has become an urgent matter in Quito since modern heritage is being threatened by the real estate industry. Particularly, Hotel Quito, no longer InterContinental, has become the target of China-based real estate developers that pretend to build high-rise towers in both extremes of the hotel, not before partially demolishing the building (Compte 2021, Mach 24).

6.0 ANALYSIS AND FINDINGS

6.1. The 'Fit for the Future' criteria, applied in the case study.

The analysis under the 'Fit for the Future' criteria (Hunt & Boyd 2017) of the proposed case study -the School of Mechanical Engineering-SME (1964) and the Administration Building-ADM (1965), designed by Oswaldo de la Torre in the Floresta campus of the Escuela Politécnica Nacional (EPN)- will be divided into two sub-criteria groups (A) addressing sustainability with engineering, and (B) addressing sustainability with architecture. For each sub-criteria group, a qualitative assessment will be conducted from two different approaches (I) technology approach (low tech, average tech, and high tech), and (II) aesthetics approach (sympathetic to the original building, minimal visual intrusion, or significantly disruptive). All the results will be portrayed in a single matrix that includes criteria, sub-criteria groups, and the assessment approaches listed above.

To begin with (A) 'addressing sustainability with engineering' through (I) 'technology approach', the level of technology required for retrofitting both SME bldg. and ADM bldg. is, as follows, A-I: 'low-tech' for 'lighting'; and, 'average-tech' for 'energy efficiency, M&E services, energy generation, electronic equipment, and maintenance'. While for (A) 'addressing sustainability with engineering' through (II) 'aesthetics approach', it has been reported in A-II that retrofitting 'sympathetic to the original building' could be met in 'underfloor heating systems'; retrofitting with 'minimal visual intrusion' in 'energy efficiency (LED lighting), lighting (guiding lights and room lights), and electronic equipment (desktop computers, data projector, acoustics, and Wi-Fi routers)', while 'significantly disruptive' retrofitting might affect 'M&E services, ventilation, energy generation (PV-panels and air-source heat pump unit); plus, 'info-screens' amongst 'electronic equipment' (interview with former administrative from EPN, Quito, November 12, 2021).

'Fit for the Future' Criteria - based on Hunt & Boyd (2017).

Addressing Sustainability with:		I. Technology approach			II. Aesthetics approach		
A	Engineering	Low Tech	Average Tech	High Tech	Sympathetic to the original building	Minimal visual intrusion	Significantly disruptive
A.1	Energy Efficiency		SME / ADM			SME / ADM	
A.1.1	LED lighting		SME / ADM			SME / ADM	
A.2	Lighting	SME / ADM				SME / ADM	
A.2.1	Quitting lights	SME / ADM				SME / ADM	
A.2.2	Room light	SME / ADM				SME / ADM	
A.3	SERVICES						
A.3.1	Mechanical		SME / ADM				SME / ADM
A.3.2	Electrical		SME / ADM				SME / ADM
A.4	Ventilation						
A.4.1	Mechanical ventilation system		SME / ADM				SME / ADM
A.5	Energy Generation						
A.5.1	PV panels		SME / ADM				SME / ADM
A.5.2	Underfloor heating systems		SME / ADM		SME / ADM		
A.5.3	Air-source heat pump unit		SME / ADM				SME / ADM
A.6	Maintenance						
A.6.1	Maintenance program		SME / ADM				
A.6.2	Staff training		SME / ADM				
A.7	Electronic equipment						
A.7.1	Desktop computers		SME / ADM			SME / ADM	
A.7.2	Data projector		SME / ADM			SME / ADM	
A.7.3	Acoustics (microphone and speakers)		SME / ADM			SME / ADM	
A.7.4	Info screens		SME / ADM				SME / ADM
A.7.5	WiFi router		SME / ADM			SME / ADM	
B	Architecture	Low Tech	Average Tech	High Tech	Sympathetic to the original building	Minimal visual intrusion	Significantly disruptive
B.1	Accessibility						
B.1.1	Ramps	SME / ADM					SME / ADM
B.1.2	Lifts		SME / ADM				SME / ADM
B.2	Daylight						
B.2.1	Windows	SME / ADM			SME / ADM		
B.2.2	Roof dome	SME / ADM					SME / ADM
B.2.3	Inner court	N.A.					
B.2.4	Solar gain and overheat	SME / ADM			SME / ADM		N.A.
B.3	Ventilation						
B.3.1	Passive ventilation system	SME / ADM					
B.4	Flooding						
B.4.1	Floodproof external shutters	SME / ADM				SME / ADM	
B.4.2	Free standing furniture	SME / ADM				SME / ADM	
B.4.3	Rain gardens	SME / ADM			SME / ADM		

LEGEND: ADM: Administration Building. SME: School of Mechanical Engineering Building. N.A.: Not applicable.

Figure 5: 'Fit for the Future' criteria applied to the case study. Source: (Author, 2020)

In regards to (B) 'addressing sustainability with architecture' through (I) 'technology approach' the level of technology required for retrofitting both SME bldg. and ADM bldg. is, as follows, B-I: 'low-tech' for 'accessibility (ramps), daylight, ventilation, and flooding'; and, 'average-tech' exclusively for 'accessibility (lifts)'. While (B) 'addressing sustainability with architecture' through (II) 'aesthetics approach', it has been reported in B-II that retrofitting 'sympathetic to the original building' could be met in 'daylight (windows, and solar gain and overheat), ventilation (passive ventilation systems), and flooding (rain gardens)'; also, retrofitting with minimal visual intrusion in 'flooding (flood-proof external shutters, and free-standing furniture); and, 'significantly disruptive' retrofitting in 'accessibility (ramps and lifts)', as well as in 'daylight (roof dome)'. Retrofitting in inner courts is not applicable (N.A.) since any of the case study buildings has an existing inner court (interview with former administrative from EPN, Quito, November 12, 2021).

Finally, findings of the analysis show that there is no single approach for retrofitting modern architectural facilities at EPN, that has become a legacy from the Cold War period. Due to the architectonic and engineering characteristics of both the School of Mechanical Engineering-SME and the Administration Building-ADM., the required approach might be one that includes specific decisions in each area of analysis: sustainability, energy efficiency, daylight, ventilation, energy generation, flooding, and maintenance, as reported in Figure 5.

CONCLUSION

To conclude, the challenges of climate change that university campuses face worldwide, have been also experienced by administrators of the Escuela Politécnica Nacional (EPN) in Quito, Ecuador. It is not only the challenge to become a sustainable institution that promotes sustainability values and sustainable lifestyles amongst students, faculty and university staff; furthermore, universities face the responsibility before the community, of becoming -at the scale of a university city- a good referent of a sustainable built environment. To assess and evaluate, from all facilities within a university campus, what should be preserved as modern architectural heritage and what should be demolished; and, to decide what is the most appropriate approach to building retrofitting, is not going to be an easy task for university administrators. However, it would be -in the coming years- a necessary one.

REFERENCES

Acosta, María. 2020. "La investigación aplicada sobre el cambio climático y ciudades en América Latina y el Caribe: retos y aportes." In *Investigación aplicada sobre cambio climático: aportes para ciudades de América Latina*, edited by Carrión, Andrea. & Acosta, María, 3-20. Quito: Editorial FLACSO Ecuador.

Anonymous. 2021. Interview with a former administrator from Escuela Politécnica Nacional by author. November 12.

Arias, Verónica. 2017, January 1. "Plan de acción climático de la ciudad de Quito." Secretaría de Ambiente del Distrito Metropolitano de Quito. Accessed November 12, 2021. <https://www.idiger.gov.co/documents/124190/164167/Estrategia+de+adaptación+y+plan+de+acción+climático+de+la+ciudad+d+e+Quito.pdf/ca0f3200-da36-4081-847e-09db60e5940e>

Barros, Juan. & Troncoso, Adriana. 2010. "Atlas Climatológico del Ecuador." Eng. diss., Escuela Politécnica Nacional. <https://bibdigital.epn.edu.ec/bitstream/15000/1720/1/CD-2755.pdf>

Brandt, M., & Rouillard, C. (2020). Climate Chaos and Heritage-Conservation Values: The Urgency for Action. *APT Bulletin: The Journal of Preservation Technology*, 51(1), 37-48. Retrieved July 3, 2021, from <https://www.jstor.org/stable/26920642>

Castañeda, L. (2012). Pre-Columbian skins, developmentalist souls. The Architect as Politician. In P. del Real, and H. Gyger. (2012). *Latin American Modern Architectures: Ambiguous Territories*. Routledge.

Chalifoux, M. 2019. "Conservation of Character-Defining Engineered Building Systems." *APT Bulletin: The Journal of Preservation Technology*, 50(4), 33-41. <https://www.jstor.org/stable/26893536>

- Compte, Florencio. 2021, March 24. "Salvar el Hotel Quito" at Expreso, Guayaquil. <https://www.expreso.com/opinion/columnas/florencio-compte/salvar-hotel-quito-101280.html>
- Den Heijer, A. 2012. "Managing the University Campus: Exploring Models for the Future and Supporting Today's Decisions", CELE Exchange, Centre for Effective Learning Environments, No. 2012/02, OECD Publishing, Paris, <https://doi.org/10.1787/5k9b950gh2xx-en>.
- Dias Comas, C.E. Heritage Agencies and the Conservation of Brazilian Modern Masterpieces: A Partial Report. *Built Heritage* 2, 35–49 (2018). <https://doi.org/10.1186/BF03545692>
- Elefante, C. (2017). Changing World, Evolving Value: A Historic Preservation Roadmap Toward 2050. *APT Bulletin: The Journal of Preservation Technology*, 48(2-3), 9-12. Retrieved July 3, 2021, from <https://www.jstor.org/stable/26250094>
- Feilden, H. 2017. *Conservation. RIBA Plan of Work 2013 Guide*. London. RIBA Publishing.
- Garcíavelez, C. 2014. *Form and Pedagogy. The Design of the University City in Latin America*. Applied Research + Design Publishing.
- González Martínez, P. The Recent Past Comes of Age. 20th-Century Heritage: Agency, Challenges and Motivations. *Built Heritage* 2, 1–3 (2018). <https://doi.org/10.1186/BF03545689>
- Grignolo, R. An Encyclopedic Approach to the Conservation of 20th-Century Architecture. *Built Heritage* 2, 93–102 (2018). <https://doi.org/10.1186/BF03545696>
- IHG Hotels & Resorts. (2021). 200 years in hospitality. It's a passion. In <https://www.ihgplc.com/en/about-us/our-history>
- InterContinental Hotels & Resorts. 2021, September 15. In Wikipedia. <https://en.wikipedia.org/wiki/InterContinental>
- Instituto Nacional de Patrimonio Cultural. 2019a. *RESOLUCIÓN No. 017-DE-INPC-2019*. Quito: INPC. http://www.patrimonio.quito.gob.ec/images/difusion/res_inv/RES-017-INPC-2019-FLORESTA.pdf
- Instituto Nacional de Patrimonio Cultural. 2019b. *RESOLUCIÓN No. 054-DE-INPC-2019*. Quito: INPC. http://www.patrimonio.quito.gob.ec/images/difusion/res_inv/RES-054-INPC-2019-FLORESTA.pdf
- Instituto Nacional de Patrimonio Cultural. 2020. *RESOLUCIÓN No. 114-DE-INPC-2020*. Quito: INPC. http://www.patrimonio.quito.gob.ec/images/difusion/res_inv/RES_114-DE-INPC-2020-inventario.pdf
- Hunt, R. and Boyd, I. 2017. *New Design for Old Buildings*. London: RIBA Publishing in association with the Society for the Protection of Ancient Buildings.
- Levi, J. 1952, November 2. PAN AMERICAN CONGRESS – A Report from Julian Levi. In *OCULUS* American Institute of Architects. New York Chapter. Vol. XV.
- MacDonald, S., Burke, S., Lardinois, S. et al. Recent Efforts in Conserving 20th-Century Heritage: The Getty Conservation Institute's Conserving Modern Architecture Initiative. *Built Heritage* 2, 62–75 (2018). <https://doi.org/10.1186/BF03545694>
- Ministerio de Cultura y Patrimonio. 2021. *Acuerdo Nro. MCYP-MCYP-2021-0030-A*. Quito: MCYP. http://www.patrimonio.quito.gob.ec/images/difusion/res_inv/acuerdo_MCYP-MCYP-2021-0030-A.pdf
- Noelle, L. 2016. Juan O' Gorman. Ingeniería de Edificios. Casas de Diego Rivera y Frida Kahlo, México, D.F., 1932. In A. Esteban-Maluenda (Ed.). In *La arquitectura Moderna en Latinoamérica*. Barcelona: Editorial Reverté.
- Normandin, K. 2018. The Stewardship of Modern Heritage: Looking Forward. *APT Bulletin: The Journal of Preservation Technology*, 49(2-3), 45-54. Retrieved July 3, 2021, from <https://www.jstor.org/stable/26502502>
- Pérez-Pérez, Marina. 2020. "Investigación aplicada en la arquitectura sostenible para el cambio climático." In *Investigación aplicada sobre cambio climático: aportes para ciudades de América Latina*, edited by Carrión, Andrea. & Acosta, María, 129-149. Quito: Editorial FLACSO Ecuador.
- Rama, G., & Tedesco, J. 1979. Education and Development in Latin America (1950-1975). *International Review of Education* 25(2/3), 187-211. Retrieved September 4, 2020, from <http://www.jstor.org/stable/3443730>
- Reid, M. 1968. Ecuador and the Eleventh Inter-American Conference. *Journal of Inter-American Studies* 10(2), 306-327. <https://www.jstor.org/stable/165392>
- Saltos, X. & Sánchez, H. 2010. "Oswaldo de la Torre". In *Miradas de la Arquitectura Moderna en Ecuador. Tomo III*. Hermida, María Augusta. Cuenca: Universidad de Cuenca.
- Sonetti, G., Brown, M. & Naboni, E. 2019. About the Triggering of UN Sustainable Development Goals and Regenerative Sustainability in Higher Education. *Sustainability* 11, 254; doi:10.3390/su11010254
- The City of Miami Beach Planning Department. 2018. *Post-War Modern MiMo Design Guidelines*. Retrieved January 14, 2022, from <https://www.miamibeachfl.gov/wp-content/uploads/2018/05/Mimo-Design-Guidelines.pdf>
- Tostões, A. Modern Built Heritage Conservation Policies: How to Keep Authenticity and Emotion in the Age of Digital Culture. *Built Heritage* 2, 17–34 (2018). <https://doi.org/10.1186/BF03545691>
- UNESCO. 2007. Nomination file 1260. *Central University City Campus of the Universidad Nacional Autónoma de México (UNAM)*. In <https://whc.unesco.org/uploads/nominations/1250.pdf>
- Wilmerding, A. Keeping It Modern: A Getty Foundation Initiative to Preserve 20th-Century Architecture. *Built Heritage* 2, 103–104 (2018). <https://doi.org/10.1186/BF03545697>
- Yates, D., Flores-Lopez, F., Estacio, J., Depsky, N., Metha, V., and Tehelen, K. (2013, November). Distrito Metropolitano de Quito: Análisis Integrado de Amenazas Relacionada con el Cambio Climático, aspectos naturales y económicos. Stockholm Environment Institute, Climate & Development Knowledge Network, and Distrito Metropolitano de Quito. In http://www.quitoambiente.gob.ec/phocadownload/cambio_climatico/Proyectos/wp1_analisis_clima_dmq.pdf
- Zografos, S. 2019. On Architectural Conservation. In *Architecture and Fire: A Psychoanalytic Approach to Conservation*, 59-87. London: UCL Press. doi:10.2307/j.ctvb6v6jq.9

Mapping of Research Lines on Circular Economy Practices in Cities: From Waste to Infrastructure

Patricia Njideka Kio¹, Ahmed Kamal Ali¹

¹Texas A&M University, College Station, TX

ABSTRACT: Economic development in cities depends, to some extent, on innovative technologies and efficient industrial management. However, industrial development leading to the growth of cities has contributed to greenhouse gas emissions; the built environment alone is responsible for up to 40% of global emissions mostly because of the linear economic model. The world is currently 9% circular, and few global initiatives seek to promote circularity especially in the building construction sector as virgin material extraction is prevalent in rapid development of cities and their infrastructure. The circular economy (CE) seeks to replace current linear practices of procuring materials to closed loops designing out waste. This study aims to map circular materials obtained from industrial byproducts and the building products made from them applying CE strategies. To that end, this paper presents a scoping literature review of current developments regarding emerging circular products and their base material sources in the industry. This review identifies emerging trends of material substitution, in current CE studies between 2011-2021 from Compendex database, Institute of Electrical and Electronics Engineers database, and the proceedings from the 10th International Conference on the Environmental and Technical Implications of Construction with Alternative Materials. This study proposes a spatiotemporal mapping of industrial byproducts in a City CE Material Source comprising available industrial by-products for use in Building Information Modelling (BIM) life-cycle stage reports and other CE impact assessment tools. Findings show that contributions of architects and product designers towards specifying circular materials for construction in the built environment is highly required for CE solutions, urban mining of physical properties of solid non-hazardous industrial waste stock is required for cities to improve their circularity. Overall, results provide an overview of possible circular products by industries, architects, and designers.

KEYWORDS: Urban mining, circular design strategies, reuse, recycle

INTRODUCTION

Cities engage in keeping stock of existing buildings and their materials to enable their future reuse through the process known as urban mining (Arora et al. 2020). Urban mining is a process of reclaiming raw materials from used products, buildings, and waste. It is also a process of recovering and reusing a city's materials that may come from buildings, infrastructure, or products that have become obsolete. Anything in the city can be part of the urban mine, bicycles, cars, and buildings (Blok 2021). Benefits of urban mining include reduced environmental costs and impacts. However, urban mining in cities has been product-centric, focusing on building in the "concrete jungle", this could be enhanced to repositories that cater for whole building material flows.

CE approaches conducted in urban areas, have resulted in various tools, frameworks and strategies however, few have addressed the role of designers towards promoting circularity in urban areas (Petrescu, Petcou, and Baibarac 2016). (Ali 2017) developed a method to integrate system thinking into architectural design by mapping its processes into a standard process modeling language. The study established a system of information exchange to support growth of emerging industrial reuse stores and vendors. It could be argued that CE principles could critically enhance the potential value streams for future reuse stocks of construction materials however, little has been achieved in terms of the paradigm shift to CE towards the selection criteria for appropriate building materials, components and elements according to CE principles (Rahla, Mateus, and Bragança 2021).

CE is currently regarded as a new topic in the building and construction industry (Leising, Quist, and Bocken 2018). Majority of studies of building stocks have focused on producing aggregated quantities of materials without providing required information for assessing the potential value streams of these quantities for future reuse (Ajayebi et al. 2020). Architects, designers, and urban planners could utilize current research results to provide direction for necessary information to assess potential value streams of future reuse, recycle and other prominent CE strategies. In addition, the expansion of existing stocks of building material banks could be achieved with more industrial input, industries could inform building professionals in real time about the quantity, size, and other physical properties of their solid non-hazardous by-products. This review of current CE literature provides information on CE material sources, products, and methodologies applied for future direction in urban mining, specification of circular materials and design decision making towards achieving a more CE. The following sections present the literature review process, current CE strategies, circular material evaluation, circular material sources, their products, and other findings.

1.0 LITERATURE REVIEW

Compendex database and the Institute of Electrical and Electronics Engineers (IEEE) database were mined using the combinations of the following key words: 1) “circular economy products building construction” and 2) “circular economy building”. In addition, proceedings from the 10th International Conference on the Environmental and Technical Implications of Construction with Alternative Materials with the theme “No cradle, no grave – circular economy into practice” were reviewed. The conference has been held every three years since 1991 and focuses on the exchange of ideas and current research on the use of waste, industrial by-products and other recycled materials in construction (Vandecasteele, Andres, and Coz 2017). In this study, a total of 282 abstracts were selected and they were filtered for circular materials and products. Further investigation was carried out into the full papers to identify specific sources of materials and products.

2.0 CIRCULAR ECONOMY STRATEGIES

The construction industry has explored ways to manage construction and demolition waste for many years. CE refuses, rethinks, reduces, reuses, repairs, refurbishes, remanufactures, repurposes, recycles and recovers (Kirchherr, Reike, and Hekkert 2017). The complex field of CE encompasses eco-parks, industrial symbiosis, supply chains, closed-loop models and business models (Homrich et al. 2018). Current studies have explored circular strategies and products through reduction (Joensuu, Edelman, and Saari 2020). Reduction in material inputs can alter value chains through multi-level policy integration (Campbell-Johnston et al. 2019). The first three Rs (refuse, rethink, reduce) avoid the use of materials while others seek to provide social, economic, and environmental benefits. Literature suggests that although recycling and energy recovery are the most common CE practices, reuse results in the highest economic and environmental benefits (Eberhardt, Birgisdottir, and Birkved 2019). The reuse strategy has been applied in some studies - (Ajayebi et al. 2020, Anastasiades et al. 2021, Arora et al. 2020, De Wolf, Hoxha, and Fivet 2020, Hossain et al. 2021, Joensuu, Edelman, and Saari 2020, Mangialardo and Micelli 2018, Munaro et al. 2019, Shojaei et al. 2021, Wang et al. 2017, Ali et al. , Ali et al. 2021). Strategies of reuse and the recent concept of replace are presented to provide additional insight towards CE strategies.

2.1. Reuse

Circular building principles are described as product recovery management, life cycle assessment (LCA), design for disassembly and adaptability (DfD/A) sequence planning, deconstruction, closed materials loops and dematerialization (Sanchez and Haas 2018). Current studies align towards reuse due to its lower consumption of primary energy and virgin materials when compared to other strategies. (Anastasiades et al. 2021) advocates towards designing buildings for disassembly using standardized components, as it is a process that remains unexplored and supports the claims of ISO 20887. The ISO 20887 provides information for owners, architects, engineers, product designers and manufacturers to assist in their understanding of potential DfD/A options and considerations, and for other parties involved in construction work. Topics of reuse focused on aggregates, building material passports (BMPs), urban reuse strategies, urban-rural symbiosis for resource recovery in integrated urban waste, water, and energy systems (Joensuu, Edelman, and Saari 2020). Concrete slurry waste, fly ash and fine recycled concrete aggregates reduced up to 82% of total carbon emissions than other strategies (Hossain et al. 2021). Methodologies to evaluate the impacts of reuse showed that current quantification methods to assess reuse give wide ranging results and do not address the full spectrum of the reuse practice; their boundaries are too limited, and several critical features are currently hardly quantifiable, such as embedded use value, versatility, storage and transformation impacts, user-owner separation, dis/re-mountability, or design complexity (De Wolf, Hoxha, and Fivet 2020). Also, a reuse case study proposed a methodological framework where material from residential buildings in Singapore were reused in low-cost houses in Indonesia and recoverable and reusable flows were highlighted (Arora et al. 2020). In addition, standardization towards DfD/A were stalled by the following- 1) protectionism of contractors who perceive standardization as a threat 2) protectionism of manufacturers who are reluctant to change the structure of their organization, and 3) designers who seem least aware of the need to implement CE in the construction sector (Anastasiades et al. 2021). The idea of exploring reusability through blockchain models where the current state of materials and their components could be tracked was demonstrated with a case study; this model could benefit reuse and recycling (Shojaei et al. 2021).

2.2. Replace

The construction and built environment in circular economy (CBECE) reviewed literature on CE stating that CBECE literature is currently at an early stage. 90% of the literature was published between 2017-2020 (Cimen 2021). A unique three-tier framework with scale, stage and subject dimensions was conducted; the two most studied CBECE subjects were “Waste Valorization” and “CE Promotion and Transition” while the two least studied subjects were “Earth Construction” and “Decoupling”. The most and least studied built environment scales were “Material” and “Area” respectively; “Operation” and “Design” were the most and least studied construction stages, respectively. At the construction stage, “Waste Valorization”, was the most studied CE subject in the “Material” scale. In the “Area” scale, no study was found at the stages of “Design”, “Manufacturing” and “End of Life”. At the “Manufacturing”, “Area” and “Planning” stages, few studies were found for “Building” and “City”. In the study the new “R” principle of “Replace” was proposed. In the strategy of replace conventional construction material with environmentally friendly alternatives to keep pollution out of the system. This idea is centered around both reuse and repurpose approaches. In the reuse approach, a by-product is used again and repurposing entails reusing discarded materials for a different purpose. The

overlap in Rs could lead to more R definitions with similar outcomes. This study proposes the principle of “reinvent” to work with reuse, repurpose and replace together. Reinvent could appeal to architects and product designers challenging them to seek more avenues towards circularity. The chain of strategies is connected and flexible, reinvent would provide a design process and procedures to specific Rs.

3.0 MATERIAL EVALUATION

3.1. Spatiotemporal mapping

Spatiotemporal distribution patterns of construction and demolition wastes were assessed at a local scale using ArcMap 10, existing maps and aerial photos to identify locations (Staunton et al. 2015). Distribution patterns of landfilling sites were assessed using vector data and remote sensing to determine sites for future landfill expansion and spatiotemporal mapping provides reliable results with other decision-making tools (Gautam, J, and R 2020). Distribution patterns from spatiotemporal mapping of solid non-hazardous industrial waste in cities could contribute to CE decision-making and impact evaluations.

3.2. Material flow analysis

The two main methods commonly used to quantify built environment stocks are the bottom-up and top-down approaches (Göswein et al. 2019). Two other methods that are less popular are demand-driven and remote sensing approaches (Tanikawa et al. 2015). Material stock accounting was carried out in Canada to provide understanding of the historical material use in cities and the consumption patterns; the bottom-up approach was used to estimate the quantity of construction materials embedded in building, road, and sidewalk stocks (Mollaei, Ibrahim, and Habib 2021). The bottom-up approach quantifies material stocks in buildings by categorizing them into similar groups and defining material intensity (MI) coefficients for them. The MI are calculated for each group of building stocks; for each category the MI are calculated in the unit of kg per m² of Gross Floor Area, which is the sum of all floor areas in the building.

3.3. Circular materials and products

Circular materials (CM) were identified from the literature, some of these materials were obtained from construction and demolition waste (C&DW), industrial by-products and material banks. Studies from the WASCON conference were grouped into papers, products, grouping criteria, materials, methodologies, and country. In some studies, CM and their products were specified, and others identified the final product, Table 1. Products include concrete covers, sports area, runways, roads and building skins. These products were grouped by their circular materials. Methods applied to evaluate the feasibility of the CM for the products were either through experimental studies, literature reviews or surveys. The experimental methodology comprised field tests and case studies, stock accounting was carried out in Canada to provide understanding of the historical material use in cities and the consumption patterns; the bottom-up approach was used to estimate the quantity of construction materials embedded in building.

Table 1: Grouping criteria, circular materials, and circular products from literature review. Source: (Authors 2022)

Grouping Criteria	Circular Material / (Study)	Circular Product
Aggregates	Clay (Ayati et al. 2018); recovery filler, fly ash, dolomitic waste, silica fume (Frank Ikechukwu and Bankole 2018); industrial scrap soil (Karayannis et al. 2016); marble scraps (Migliore et al. 2018); fly ash (Modolo et al. 2018); ceramic sludge (Sánchez de Rojas et al. 2018); bottom ash (Vaitkus et al. 2019); concrete slurry waste (Hossain et al. 2021); concrete waste (Wang et al. 2017); bottom ash, slag, crushed concrete, calcite enrichment sand, and fibre clay (WASCON).	Light weight aggregate, self-compacting concrete, bricks, blocks, cement, mortars, paving units, base layer, cement-free partition wall blocks, overpass, cover structure, sports area, roads, highways, and embankments
Plastics	Polystyrene (del Rio Merino et al. 2019); polycarbonates, polystyrenes and mixed plastics (Mondal, Bose, and Bansal 2019); recycled aggregates (Martinho, Picado-Santos, and Capitao 2018); plastic matrix trays (Ali et al. 2021).	Lightweight gypsums, bricks, pavements asphalt mixtures, autonomous shading device
Steel	C&DW steel (Minunno et al. 2018) Scrap metal (Ali et al. 2020); (Ali, Wang, and Alvarado 2019).	Prefabricated buildings, Building envelopes
Wood	Secondary timber (Rose et al. 2018), cork wastes (Sierra-Pérez et al. 2018); recovered solid wood (Husgafvel et al. 2018); paper mill waste (WASCON).	Wood products, cross-laminated timber, aerodrome runway
Others	Foamed glass, rubber, and feed materials (WASCON)	Binders, road pavements, earthworks, urban resource cadastre, wood frame constructive system

4.0 DISCUSSION

From the literature review, this study identified the circular materials' source, grouping criteria of their base material, resulting product and the methodology applied to test the products. Products were grouped into aggregates, plastic, steel, wood, and others. These groups of materials resulted in seventeen diverse products such as concrete, bricks, cement, blocks, roads, lightweight gypsum boards, pavements, asphalt mixture, shading device, cross laminated timber, wooden products, insulation boards, aerodrome runway, building skins, prefabricated buildings, binder, and rubber. The circular materials, design strategies and methodologies are discussed in the following sections.

4.1. On circular material selection

CM reviewed show that aggregate materials such as fly ash, bottom ash and incineration resulted in products such as bricks, cement, and pavements. Soil recovered from industrial processes were used for concrete, aggregates, and bricks. Plastic by-products were secondary materials for gypsum board, asphalt, and bricks. Wood, cork, and paper wastes were used in CLT timber, insulation boards and aerodrome runways. A Sankey diagram shows the groups of circular materials and their products, Figure 1.

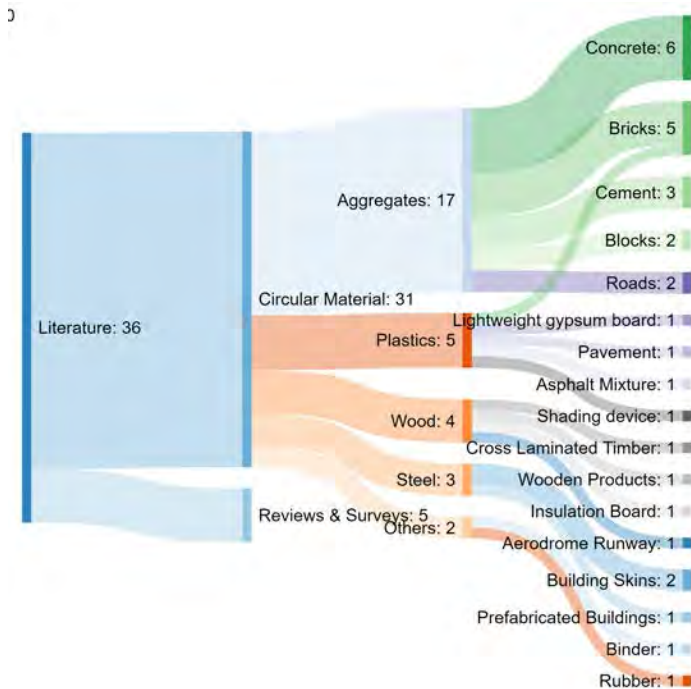

Figure 1: Circular materials, products and focus of literature. Source: (Author 2022)

4.2. On design strategies

Design strategies that promote CE include design for disassembly, recyclability, and deconstruction (Rios, Chong, and Grau 2015). Definitions of disassembly and deconstruction are similar, in both cases the designer anticipates future change in the structure of the infrastructure and designs to enable ease of dismantling during its life span or at end of life. Many CE challenges exist in design, case-specific CE implementation through case-specific building with full scale evaluation is encouraged (Hossain et al. 2020). This provides opportunities for further development of CE research and implementation in the building construction industry and could promote sustainable construction.

4.3. On methodologies

The methods applied in CE such as life cycle assessment (LCA), material flow analysis (MFA) and input-output analysis were utilized in experimental studies which were the most prevalent in current CE studies, Figure 2. The bulk of the studies thirty-three, were carried out using experimental methods; case studies, field experiments and laboratory experiments were classified under experimental studies, 86%. Literature reviews were five, 8% of the studies and surveys were used in two of the studies, 6%.

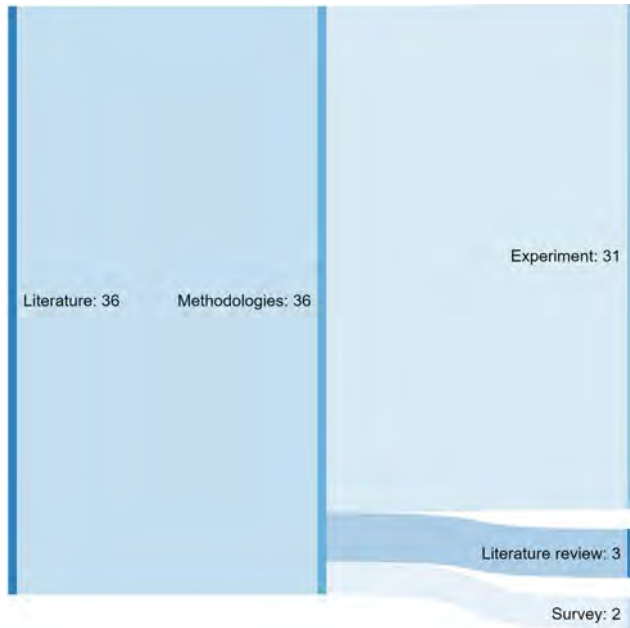

Figure 2: Research methods from circular materials to products. Source: (Author 2022)

To improve the number of available CM, this study proposes a spatiotemporal mapping of industrial byproducts in a City Circular Economy Material Source (CCEMS). Distribution patterns of industrial by-products could be assessed in a city-by-city basis to address problems caused by commercial sensitivity regarding information on the size and geometry of solid non-hazardous industrial waste. The CCEMS would provide information to Building Information Modelling (BIM) CE tools to evaluate impacts of CM choices in designs. For example, when more information on more CM materials is provided, an LCA evaluation software like Tally (a plug in for Revit) would return significant reporting at life-cycle stage concerning impacts on more scenarios, Figure 3. The United States Waste Reduction Model uses the size of materials to calculate impacts and the CCEMS would aid in decision making towards CM choices and CE strategies in cities and states. Research in CE requires a synthesis of knowledge gained across domains, particularly in the understanding of underlying barriers, integrative methodological advances such as expanded use of consequential LCA, development of physical Input-Output tables, and integrating MFA with dynamical models (Singh et al. 2021). Also, current LCA tools are not appropriate to evaluate the environmental impact of a building when its components originate from prior buildings and/or will be used in future unknown ones therefore, robust measurement should be provided to demonstrate benefits of reuse towards environmentally sustainable cities (De Wolf, Hoxha, and Fivet 2020).



Figure 3: Flow of information to City Circular Economy Material Source and Building Information Models. Source: (Author 2022)

CONCLUSION

This study carried out a scoping review of literature on circular economy materials and products in the building construction industry to determine emerging trends. 282 abstracts from Compendex and Institute of Electrical and Electronics Engineers (IEEE) Explorer databases were reviewed. In addition, conference proceedings from the 10th International Conference on the Environmental and Technical Implications of Construction with Alternative Materials (WASCON) were also reviewed. Key findings from this study concluded that most studies were experimental in the form of case studies, field experiments and laboratory testing. Circular materials were grouped into aggregates, plastics, wood, steel, and others. Circular products typically consisted of bricks, boards, concrete, pavement, block, mortar, cement, and aggregates. This study proposed a city-by-city spatiotemporal mapping for a City Circular Economy Material Source (CCEMS). When industrial waste owners and collectors of solid non-hazard industrial waste provide information on the size, geometry, and physical properties of industrial by-products, it will encourage architects, designers and building professionals to specify circular materials and products towards higher circularity. Future studies will focus on systematic literature reviews and surveys applying big data for large scale circular economy approaches. Innovation for interior circular products is encouraged to improve public acceptance of industrial by-products. Finally, circular economy initiatives could be tied to identities of cities representing them in more sustainable future.

ACKNOWLEDGEMENTS

This document contains some material from the proceedings of the 10th International Conference on the Environmental and Technical Implications of Construction with Alternative Materials (WASCON) with the theme "No cradle, no grave – circular economy into practice". The contribution of the Finnish Association of Civil Engineers (RIL ry) conference organizers and committees is hereby gratefully acknowledged.

REFERENCES

- Ajayebe, Atta, Peter Hopkinson, Kan Zhou, Dennis Lam, Han-Mei Chen, and Yong Wang. 2020. "Spatiotemporal model to quantify stocks of building structural products for a prospective circular economy." *Resources, Conservation and Recycling* 162:105026. doi: <https://doi.org/10.1016/j.resconrec.2020.105026>.
- Ali, Ahmed K, Patricia N Kio, Jorge Alvarado, and Yi Wang. "Symbiotic Circularity in Buildings: An Alternative Path for Valorizing Sheet Metal Waste Stream as Metal Building Facades." *Waste and Biomass Valorization*:1-19.
- Ali, Ahmed K., Patricia N. Kio, Jorge Alvarado, and Yi Wang. 2020. "Symbiotic Circularity in Buildings: An Alternative Path for Valorizing Sheet Metal Waste Stream as Metal Building Facades." *Waste and Biomass Valorization* 11 (12):7127-7145. doi: 10.1007/s12649-020-01060-y.
- Ali, Ahmed K., Astrid Layton, Patricia Kio, and Jewel Williams. 2021. "Matrix Trays: From waste to opportunities." *Journal of Cleaner Production* 300:126813. doi: <https://doi.org/10.1016/j.jclepro.2021.126813>.
- Ali, Ahmed K., Yi Wang, and Jorge L. Alvarado. 2019. "Facilitating industrial symbiosis to achieve circular economy using value-added by design: A case study in transforming the automobile industry sheet metal waste-flow into Voronoi facade systems." *Journal of Cleaner Production* 234:1033-1044. doi: 10.1016/j.jclepro.2019.06.202.
- Ali, Ahmed Kamal. 2017. "Architecture within a circular economy: Process mapping a resource-based design-bid-build project delivery system." *Enquiry: A Journal for Architectural Research* 14 (1):48-61.
- Anastasiades, K., J. Goffin, M. Rinke, M. Buyle, A. Audenaert, and J. Blom. 2021. "Standardisation: An essential enabler for the circular reuse of construction components? A trajectory for a cleaner European construction industry." *Journal of Cleaner Production* 298. doi: 10.1016/j.jclepro.2021.126864.
- Arora, Mohit, Felix Raspall, Lynette Cheah, and Arlindo Silva. 2020. "Buildings and the circular economy: Estimating urban mining, recovery and reuse potential of building components." *Resources, Conservation and Recycling* 154. doi: 10.1016/j.resconrec.2019.104581.
- Ayati, Bamdad, Veronica Ferrándiz-Mas, Darryl Newport, and Christopher Cheeseman. 2018. "Use of clay in the manufacture of lightweight aggregate." *Construction and Building Materials* 162:124-131. doi: <https://doi.org/10.1016/j.conbuildmat.2017.12.018>.
- Blok, Merlijn. 2021. Urban mining and circular construction – what, why and how it works. edited by Metabolic. Netherlands.
- Campbell-Johnston, Kieran, Joey ten Cate, Maja Elfering-Petrovic, and Joyeeta Gupta. 2019. "City level circular transitions: Barriers and limits in Amsterdam, Utrecht and The Hague." *Journal of Cleaner Production* 235:1232-1239. doi: 10.1016/j.jclepro.2019.06.106.
- Cimen, Omer. 2021. "Construction and built environment in circular economy: A comprehensive literature review." *Journal of Cleaner Production* 305. doi: 10.1016/j.jclepro.2021.127180.
- De Wolf, Catherine, Endrit Hoxha, and Corentin Fivet. 2020. "Comparison of environmental assessment methods when reusing building components: A case study." *Sustainable Cities and Society* 61. doi: 10.1016/j.scs.2020.102322.
- del Rio Merino, Mercedes, Paola Villoria Sáez, Iolanda Longobardi, Jaime Santa Cruz Astorqui, and César Porrás-Amores. 2019. "Redesigning lightweight gypsum with mixes of polystyrene waste from construction and demolition waste." *Journal of Cleaner Production* 220:144-151. doi: <https://doi.org/10.1016/j.jclepro.2019.02.132>.

- Eberhardt, Leonora Charlotte Malabi, Harpa Birgisdottir, and Morten Birkved. 2019. "Potential of Circular Economy in Sustainable Buildings." 3rd World Multidisciplinary Civil Engineering, Architecture, Urban Planning Symposium, WMCAUS 2018, June 18, 2018 - June 22, 2018, Prague, Czech republic.
- Frank Ikechukwu, Aneke, and Awuzie Bankole. 2018. "Conversion of industrial wastes into marginal construction materials." *Acta Structilia* (2):119. doi: 10.18820/24150487/as25i2.5.
- Gautam, Sneha, Brema J, and Dhasarathan R. 2020. "Spatio-temporal estimates of solid waste disposal in an urban city of India: A remote sensing and GIS approach." *Environmental Technology & Innovation* 18:100650. doi: <https://doi.org/10.1016/j.eti.2020.100650>.
- Göswein, Verena, José Dinis Silvestre, Guillaume Habert, and Fausto Freire. 2019. "Dynamic Assessment of Construction Materials in Urban Building Stocks: A Critical Review." *Environmental Science & Technology* 53 (17):9992-10006. doi: 10.1021/acs.est.9b01952.
- Homrich, Aline Sacchi, Graziela Galvão, Lorena Gamboa Abadia, and Marly M. Carvalho. 2018. "The circular economy umbrella: Trends and gaps on integrating pathways." *Journal of Cleaner Production* 175:525-543. doi: <https://doi.org/10.1016/j.jclepro.2017.11.064>.
- Hossain, Md Uzzal, S. Thomas Ng, Prince Antwi-Afari, and Ben Amor. 2020. "Circular economy and the construction industry: Existing trends, challenges and prospective framework for sustainable construction." *Renewable and Sustainable Energy Reviews* 130. doi: 10.1016/j.rser.2020.109948.
- Hossain, Md Uzzal, Dongxing Xuan, S. Thomas Ng, and Ben Amor. 2021. "Designing sustainable partition wall blocks using secondary materials: A life cycle assessment approach." *Journal of Building Engineering* 43. doi: 10.1016/j.jobe.2021.103035.
- Husgafvel, R., L. Linkosalmi, M. Hughes, J. Kanerva, and O. Dahl. 2018. "Forest sector circular economy development in Finland: A regional study on sustainability driven competitive advantage and an assessment of the potential for cascading recovered solid wood." *Journal of Cleaner Production* 181:483-497. doi: <https://doi.org/10.1016/j.jclepro.2017.12.176>.
- Joensuu, Tuomo, Harry Edelman, and Arto Saari. 2020. "Circular economy practices in the built environment." *Journal of Cleaner Production* 276. doi: 10.1016/j.jclepro.2020.124215.
- Karayannis, V., K. Ntampeliotis, S. Lamprakopoulos, D. Kasiteropoulou, G. Papapolymerou, and X. Spiliotis. 2016. DEVELOPMENT OF EXTRUDED AND SINTERED CLAY BRICKS WITH BENEFICIAL USE OF INDUSTRIAL "SCRAP-SOIL" AS ADMIXTURE.
- Kirchherr, Julian, Denise Reike, and Marko Hekkert. 2017. "Conceptualizing the circular economy: An analysis of 114 definitions." *Resources, Conservation and Recycling* 127:221-232. doi: <https://doi.org/10.1016/j.resconrec.2017.09.005>.
- Leising, Eline, Jaco Quist, and Nancy Bocken. 2018. "Circular Economy in the building sector: Three cases and a collaboration tool." *Journal of Cleaner Production* 176:976-989. doi: <https://doi.org/10.1016/j.jclepro.2017.12.010>.
- Mangialardo, Alessia, and Ezio Micelli. 2018. "Rethinking the construction industry under the circular economy: Principles and case studies." In, 333-344. Springer Verlag.
- Martinho, F. C. G., L. G. Picado-Santos, and S. D. Capitao. 2018. Feasibility Assessment of the Use of Recycled Aggregates for Asphalt Mixtures.
- Migliore, Marco, Cinzia Talamo, Mauro Carpinella, Franco Paolieri, and Giancarlo Paganin. 2018. "INNOVATIVE USE OF SCRAP AND WASTE DERIVING FROM THE STONE AND THE CONSTRUCTION SECTOR FOR THE MANUFACTURING OF BRICKS. REVIEW OF THE INTERNATIONAL SCENARIO AND ANALYSIS OF AN ITALIAN CASE STUDY." *Environmental Engineering & Management Journal (EEMJ)* 17 (10):2507-2514.
- Minunno, Roberto, Timothy O'Grady, Gregory M. Morrison, Richard L. Gruner, and Michael Colling. 2018. "Strategies for Applying the Circular Economy to Prefabricated Buildings." *Buildings* 8 (9):125.
- Modolo, R. C. E., L. Senff, V. M. Ferreira, L. A. C. Tarelho, and C. A. M. Moraes. 2018. "Fly ash from biomass combustion as replacement raw material and its influence on the mortars durability." *Journal of Material Cycles & Waste Management* 20 (2):1006-1015. doi: 10.1007/s10163-017-0662-9.
- Mollaei, Aida, Nadine Ibrahim, and Komal Habib. 2021. "Estimating the construction material stocks in two canadian cities: A case study of Kitchener and Waterloo." *Journal of Cleaner Production* 280. doi: 10.1016/j.jclepro.2020.124501.
- Mondal, M. K., B. P. Bose, and P. Bansal. 2019. "Recycling waste thermoplastic for energy efficient construction materials: An experimental investigation." *Journal of Environmental Management* 240:119-125. doi: <https://doi.org/10.1016/j.jenvman.2019.03.016>.
- Munaro, M. R., A. C. Fischer, N. C. Azevedo, and S. F. Tavares. 2019. "Proposal of a building material passport and its application feasibility to the wood frame constructive system in Brazil." SBE 2019 Brussels - BAMB-CIRCPATH: Buildings as Material Banks - A Pathway For A Circular Future, February 5, 2019 - February 7, 2019, Brussels, Belgium.
- Petrescu, Doina, Constantin Petcou, and Corelia Baibarac. 2016. "Co-producing commons-based resilience: lessons from R-Urban." *Building Research and Information* 44 (7):717-736. doi: 10.1080/09613218.2016.1214891.
- Rahla, Kamel Mohamed, Ricardo Mateus, and Luís Bragança. 2021. "Selection Criteria for Building Materials and Components in Line with the Circular Economy Principles in the Built Environment—A Review of Current Trends." *Infrastructures* 6 (4):49.

- Rios, Fernanda Cruz, Wai K. Chong, and David Grau. 2015. "Design for Disassembly and Deconstruction - Challenges and Opportunities." *Procedia Engineering* 118:1296-1304. doi: <https://doi.org/10.1016/j.proeng.2015.08.485>.
- Rose, C. M., D. Bergsagel, T. Dufresne, E. Unubreme, T. Lyu, P. Duffour, and J. A. Stegemann. 2018. "Cross-laminated secondary timber: Experimental testing and modelling the effect of defects and reduced feedstock properties." *Sustainability (Switzerland)* 10 (11). doi: 10.3390/su10114118.
- Sanchez, Benjamin, and Carl Haas. 2018. "Capital project planning for a circular economy." *Construction Management and Economics* 36 (6):303-312. doi: 10.1080/01446193.2018.1435895.
- Sánchez de Rojas, María Isabel, Moisés Frías, Elvira Sabador, Eloy Asensio, Julián Rivera, and César Medina. 2018. "Use of ceramic industry milling and glazing waste as an active addition in cement." *Journal of the American Ceramic Society* 101 (5):2028. doi: 10.1111/jace.15355.
- Shojaei, Alireza, Roozbeh Ketabi, Mohamad Razkenari, Hamed Hakim, and Jun Wang. 2021. "Enabling a circular economy in the built environment sector through blockchain technology." *Journal of Cleaner Production* 294. doi: 10.1016/j.jclepro.2021.126352.
- Sierra-Pérez, J., S. García-Pérez, S. Blanc, J. Boschmonart-Rives, and X. Gabarrell. 2018. "The use of forest-based materials for the efficient energy of cities: Environmental and economic implications of cork as insulation material." *Sustainable Cities and Society* 37:628-636. doi: <https://doi.org/10.1016/j.scs.2017.12.008>.
- Singh, Shweta, Callie Babbitt, Gabrielle Gaustad, Matthew J. Eckelman, Jeremy Gregory, Erinn Ryen, Nehika Mathur, Miriam C. Stevens, Abhijeet Parvatker, Raj Buch, Alicia Marseille, and Thomas Seager. 2021. "Thematic exploration of sectoral and cross-cutting challenges to circular economy implementation." *Clean Technologies and Environmental Policy* 23 (3):915-936. doi: 10.1007/s10098-020-02016-5.
- Staunton, John, Chris D. Williams, Liam Morrison, Tiernan Henry, Gerard T. A. Fleming, and Michael J. Gormally. 2015. "Spatio-temporal distribution of construction and demolition (C&D) waste disposal on wetlands: A case study." *Land Use Policy* 49:43-52. doi: <https://doi.org/10.1016/j.landusepol.2015.06.023>.
- Tanikawa, Hiroki, Tomer Fishman, Keijiro Okuoka, and Kenji Sugimoto. 2015. "The Weight of Society Over Time and Space: A Comprehensive Account of the Construction Material Stock of Japan, 1945–2010." *Journal of Industrial Ecology* 19 (5):778-791. doi: <https://doi.org/10.1111/jiec.12284>.
- Vaitkus, Audrius, Judita Gražulytė, Ovidijus Šernas, Viktoras Vorobjovas, and Rita Kleizienė. 2019. "An algorithm for the use of MSWI bottom ash as a building material in road pavement structural layers." *Construction and Building Materials* 212:456-466. doi: <https://doi.org/10.1016/j.conbuildmat.2019.04.014>.
- Vandecasteele, Carlo, Ana Andres, and Alberto Coz. 2017. "WASCON 2015: Resource Efficiency in Construction." *Waste and Biomass Valorization* 8 (5):1379-1380. doi: 10.1007/s12649-017-9999-5.
- Wang, Shoubing, Ziran Xu, Weiqian Zhang, Zhengqiu Fan, Shuqing Feng, and Yan Liu. 2017. "Effects of aggregate reuse for overpass reconstruction-extension projects on energy conservation and greenhouse gas reduction: A case study from Shanghai City." *Journal of Cleaner Production* 140:1444-1453. doi: 10.1016/j.jclepro.2016.10.007.

Beyond Operational Energy Efficiency: A Balanced Sustainability Index from a Life Cycle Consideration

Ming Hu¹

¹University of Maryland, College Park, MD

ABSTRACT: Most deep energy renovation projects focus only on an operating energy reduction and disregard the added embodied energy derived from adding insulation, window/door replacement, and mechanical system replacement or upgrades. It is important to study and address the balance and trade-offs between reduced operating energy and added embodied energy from a whole life cycle perspective to reduce the overall building carbon footprint. However, the added embodied energy and related environmental impact have not been studied extensively. In response to this need, this paper proposes a holistic sustainability index that balances the trade-off between reduced operating energy and added embodied energy. Seven case projects are used to validate the proposed method and calculation. The findings demonstrate that using a balanced sustainability index can reveal results different from a conventional operating energy-centric approach: (a) operating energy savings can be offset by the embodied energy gain, and (b) the operating energy savings do not always result in a life cycle emissions reduction.

KEYWORDS: Sustainability index, Life cycle consideration, embodied energy, Operational energy

INTRODUCTION

In recent years, there have been studies focusing on the trade-off between embodied and operating carbon. Crawford et al. (2010) studied the impact of different building materials of eight residential construction assemblies; a theoretical generic building was used as a base building. Rossello-Batel et al. (2015) studied the relation between reduced heating demand and the embodied energy of different building typologies and building envelope options. They found that adding additional insulation in the façade can reduce energy demand to one third of the existing condition, while having the highest increase in embodied energy. Stephan et al. (2013) also found the increase of insulation in passive houses could reduce the heating demand in the winter, but such a decrease was offset by the higher embodied energy embedded in the insulation materials. With the increase of research on the relation between embodied and operating carbon, majority studies were conducted on theoretical conditions using simulated data. Studies using data from actual renovated buildings are limited due to inaccessibility of the data.

The importance of understanding the trade-off between operating and embodied energies and their related carbon emissions has been gradually recognized by practitioners and researchers. Consequently, creating a comprehensive and holistic measurement of sustainability for building energy retrofits has become an emerging research topic. However, there have been very few studies and efforts on this topic, and proposed measurements varied much. For example, Bakar et al. (2015) proposed using an energy efficiency index as an indicator for measuring building energy performance. Such an index is calculated as the ratio of the energy input to the factor related to the energy-using component. The embodied energy was included as one related factor and measured by the weight of the raw material used. Varusha et al. (2020) suggested using the EE factor to quantify the trade-off between the embodied and operating energies of a building. The EE factor is calculated as the ratio of operating energy to embodied energy of a proposed building design against the ratio of a base building based on the ASHRAE 2016 benchmark. Triana et al. (2021) proposed a sustainability index in the building life cycle energy use that includes life cycle energy consumption, life cycle carbon emissions, thermal comfort hours, and cost of the building energy life cycle. Those four values are added together and then divided by four to get the sustainability index. However, there is no sustainability index proposed particularly for a building retrofit yet. To respond to such a research gap, the aim of this study is to reveal the importance of considering embodied energy in current energy retrofit practices since the most energy-efficient building is not necessarily the most sustainable building. Consequently, a comprehensive measure of the sustainability of a renovation project is proposed to measure the effectiveness of a building energy retrofit by integrating the life cycle assessment.

1.0 STUDIED BUILDINGS

1.1 Selection of buildings

Eight projects were used in this study to control the variables of building size, age, building system used, and local climate condition. All eight buildings are located in the same city and built around similar periods, with the energy retrofits mainly focused on the buildings' heating system and exterior façade. The eight buildings are part of the "European cities serving as Green Urban Gate towards leadership in sustainable energy" (EU_GUGLE) project (EU-

GUGLE). The project aimed to demonstrate the feasibility of a nearly zero energy building renovation target; it started in 2013 and lasted for six years. Six pilot cities from Italy, Austria, Finland, Denmark, Estonia, and Slovakia participated in the project. Around 200,000 m² of gross floor area was renovated and targeted primary (source) energy savings of up to 82%. Eight buildings in Tampere, Finland, participated in EU_GUGLE. All eight buildings are in the Tammela district, a traditional residential district close to the city center and railway station. There is a total of around 299,000 m² of existing building stock in Tammela district. The current average energy use intensity is 213 kWh/m², and the target intensity is 160 kWh/m² (EU-GUGLE), around a 25% operating energy reduction.

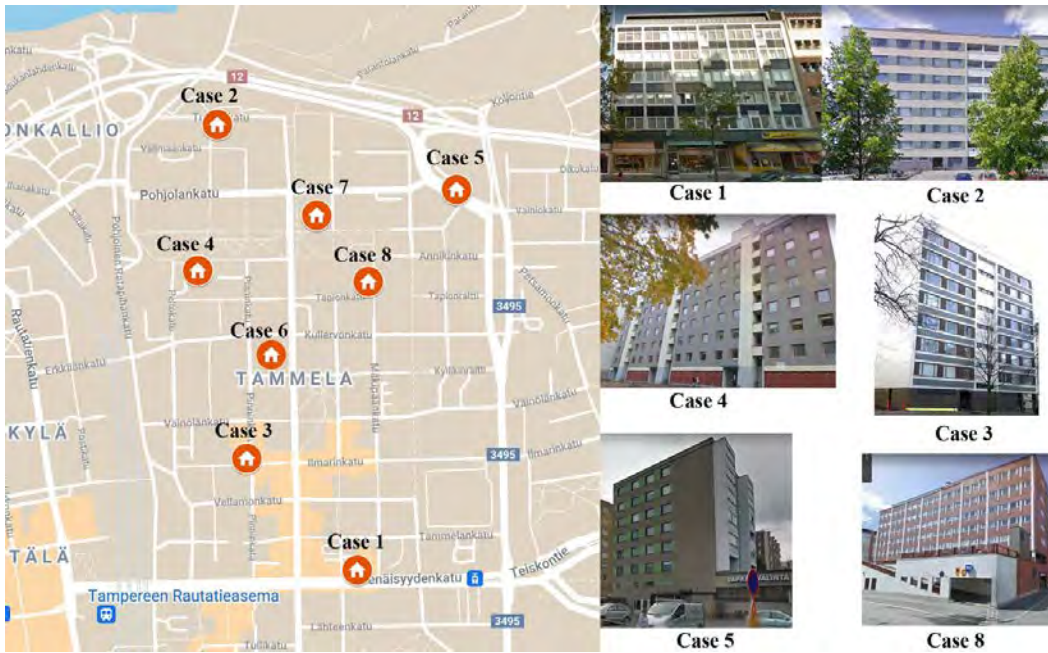

Figure 1: Studied projects location map

1.2 Case building physical characteristics

The studied buildings were built between 1961 and 1980; the renovations were completed between 2014 and 2019. Seven buildings have six floors and one has four floors—only the four-story building was built in the first half of the 1960s. All eight buildings selected reflected a typical building constructed in the 1960s and 1970s before building energy regulations were enforced in Finland (Hirvonen et al., 2019). According to Niemelä et al. (2017), Finnish multifamily buildings constructed in the first half of the 1960s were normally built on-site with a tile building façade and “bookshelf-type” framework. Beginning in the late 1960s, prefabricated large concrete panels became the main construction type (Nemelä et al., 2017). In fact, all the studied buildings had prefabricated concrete panels. The information on existing building service systems—including heating, ventilation, and plumbing systems—was provided by the project team and extracted from the project website. The renovations applied to each case building were also obtained from the project report, which is publicly accessible information. The breakdown description for each individual building can be found in Table 1 and is explained in the following section.

1.3. Renovation strategies and measures

The technical improvements applied to the projects to reduce the operating energy demand are listed below as R1 through R15.

Table 1 lists the applied renovation techniques for each case building.

- R1 Exterior wall: additional mineral wool insulation (+/- 200 mm) + plaster render
- R2 Roof: additional light gravel layer (+/-200 mm) + additional polyurethane insulation (+/-200 mm) + lightweight concrete (+/- 40 mm) + bitumen membrane waterproofing
- R3 Replace existing windows with energy-efficient ones
- R4 Replace existing doors with energy-efficient ones
- R5 Renew the thermostat radiator valves and adjust the heating network
- R6 Add heat recovery from exhaust air in the ventilation system
- R7 Air-to-air heat pump
- R8 Air-to-water heat pump
- R9 Ground source heat pump (for heating and cooling)
- R10 Connect to municipal district heating network
- R11 Replace existing lighting with LED lights
- R12 Add meter to monitor the water consumption
- R13 Remote energy use monitoring
- R14 Replace water faucets with more energy-efficient ones

RESILIENT CITY
 Physical, Social, and Economic Perspectives
 R15 Replace existing elevator with more energy-efficient ones
 NC No change

Table 1: Applied renovation techniques for each individual case building

	Case 1	Case 2	Case 3	Case 4	Case 5	Case 6	Case 7	Case 8
External wall	R1	R1	NC	NC	NC	R1	NC	R1
Roof system	R2	R2	NC	NC	NC	R2	NC	R2
Exterior window	R3	R3	R3	R3		R3	R3	R3
Exterior door	R3	R3	R3	R3	NC	R3	R3	R3
Internal wall	NC	NC	NC	NC	NC	NC	NC	NC
Floor system	NC	NC	NC	NC	NC	NC	NC	NC
Lighting	R11	R11				R11	R11	R11
Heating system	R9	R7, R10	R5, R8, R10	R5, R9	R8, R9, R10	R5, R9, R10	R5, R7, R9, R10	R5, R7, R10
Ventilation	R6	R6	R6	R6	R6	R6	R6	R6
Building management	R13	R13	R13	R13	R13	R13	R13	R13
Water supply	NC	NC	R14	NC	NC	NC	R12	R12, R14
Vertical transportation	NC	NC	R15	NC	NC	NC	NC	NC

1.4. Embodied energy and carbon emissions calculation

The software One Click LCA™, developed by the Finish private company Bionova Ltd, was chosen for this study. The software complies with EN 15987 and EN 15804 standards, and EN 15804 is a guideline for Environmental Product Declarations based on the ISO 14044 standard. One Click LCA includes the building material database, which is European original and Finland-specific (Petrovic et al., 2019). In this project, life cycle carbon emissions are calculated for individual case projects. To normalize the added embodied energy, only renovated components are included: the building envelope, heating/ventilation system, and lighting system. Structural systems and other building service systems are excluded as they were not changed. Furniture and interior finishes are excluded as well. The life stage included in this study is A through C. Stage A is the product and construction stage and includes A1 through A5. A1 through A3 is usually called “cradle to gate,” and A1 through A5, “cradle to site.” Stage B is the use stage, and stage C is the end-of-life stage. A1 through C3 is typically named “cradle to grave.” The data used to create the LCA model are extracted from original construction documents provided by the project team and the author’s visual inspection on-site. Information extracted from the EU-GUGLE website, publications, presentations, and other available information can be found online. A life span of 50 years is used for the calculation, and the product service life is set as the default; for example, wood panels, the roof, and windows are set to be replaced once during the building’s lifetime (50 years), and doors are set to be changed twice during the building’s lifetime. In addition, in the One Click LCA database, transportation carbon is included during the production stage (Petrovic et al., 2019).

2.0 PROPOSED SUSTAINABILITY INDEX

2.1. Sustainability index definition

In this study, sustainability of the renovation project is measured by the balance (trade-off) between reduced carbon emissions (through operating energy savings) and added carbon emissions (through added building materials and systems). The framework proposed by Moran et al. (2020) was adopted and modified to calculate the sustainability of a retrofit solution, using (Equation 1 through Equation 4:

$$SC_n = \frac{aOES_n + bEMB_n + cECO_n}{k} \tag{Equation 1}$$

Where a, b, and c are weighting factors for each of the respective categories; k is $\sum(a, b, c)$; OES_n is the life cycle carbon reduction due to the operating energy savings of case project n, measured by the operational cost savings (CO_2 -eq/ m^2); and EMB_n is the life cycle carbon increase due to the embodied energy added, measured by the carbon emissions equivalent (CO_2 -eq/ m^2); ECO_n is the economic impact of case project n, measured by the operational cost savings ($\$/m^2$). The calculation of OES_n , EMB_n , and ECO_n can be expressed mathematically as Equation 2 through Equation 4:

$$OES_n = \sum_{m=1}^q \left[\left(\frac{oES_{m,n}}{\left(\frac{\sum_{n=1}^p oES_{m,n}}{p} \right)} \right) w_m \right] \tag{Equation 2}$$

$$EMB_n = \sum_{m=1}^q \left[\left(\frac{emb_{m,n}}{\left(\frac{\sum_{n=1}^p emb_{m,n}}{p} \right)} \right) w_m \right]$$

Equation 3

$$ECO_n = \sum_{m=1}^q \left[\left(\frac{eco_{m,n}}{\left(\frac{\sum_{n=1}^p eco_{m,n}}{p} \right)} \right) w_m \right]$$

Equation 4

Where $oes_{m,n}$ is the life cycle carbon reduction indicator m for case project n ; m stands for the different operating energy, electricity, and district heating. $emb_{m,n}$ is the life cycle carbon increase indicator m for case project n ; m represents the building elements, such as the exterior wall and windows. $eco_{m,n}$ is the economic indicator m for case project n . w_m is the weighting applied for each indicator depending on the category's importance, q is the number of the indicators evaluated in each carbon emissions reduction, carbon emissions increase, and economic category, and p is the total floor area measured. The sum of the weightings ($\sum(w_m)$) applied to indicators in each category must add up to one. As can be seen from (Equation 1), each of the three categories for the sustainability score can be given a different weighting (a, b, c) depending on the importance of the category. The importance of the categories for different stakeholders involved in the energy retrofit projects can vary. For example, the energy supplier and building operators' priority is most likely the operating energy savings. But for environmental protection agencies who are involved in permit review, the added embodied carbon is equally critical since it can lead to unintended environmental impacts. For building owners, the operational cost may be the primary reason for choosing retrofit solutions. In section **Error! Reference source not found.**, the impact of different weightings on the sustainability index are demonstrated.

3.0. FINDINGS

3.1 Life cycle carbon emissions

As showed in Figure 2, case 1 ranked first, with the highest life cycle emissions due to high energy use during the B6 stage, followed by case 5 and case 3 as the top life cycle carbon emitters, also due to the high energy demand in their use life stage. For all case buildings, the B6 stage is the dominant life cycle stage for carbon emissions, contributing around 57%–83% of the total life cycle carbon emissions. These findings validate the importance of further reducing the use stage energy demand through a deep energy retrofit. Figure 2 also shows that the second highest life cycle stage contributing to life cycle carbon emissions is A1–A3, the product stage, or “cradle to gate” (Jiménez-González et al. 2004). The fractional contributions from the remaining life cycle stages are negligible. When we normalize the life cycle emissions by the number of units included in the studied buildings (refer to Figure 4b), the results are different: case 1 ranked first with the highest life cycle carbon emissions per unit, more than 50% higher than the emissions from case 4 (ranked second) and 60% higher than case 8 (ranked third). Since we can use the number of units as a proxy for the number of occupants in the building, we can interpret the normalized results by unit numbers as an indicator of inequality regarding the carbon emissions burden that each occupant imposes on the larger environment. For example, case building 4 has fewer occupants; however, each occupant is responsible for higher life cycle carbon emissions, compared to other case buildings' occupants (except case 1). In the future, we suggest using the number of units to normalize the life cycle carbon emissions, which can better reveal the inequality among different buildings and building occupants. Despite the difference, normalized life cycle carbon emissions by unit also demonstrate that the B6 use phase is the dominant life cycle stage and needs further reductions.

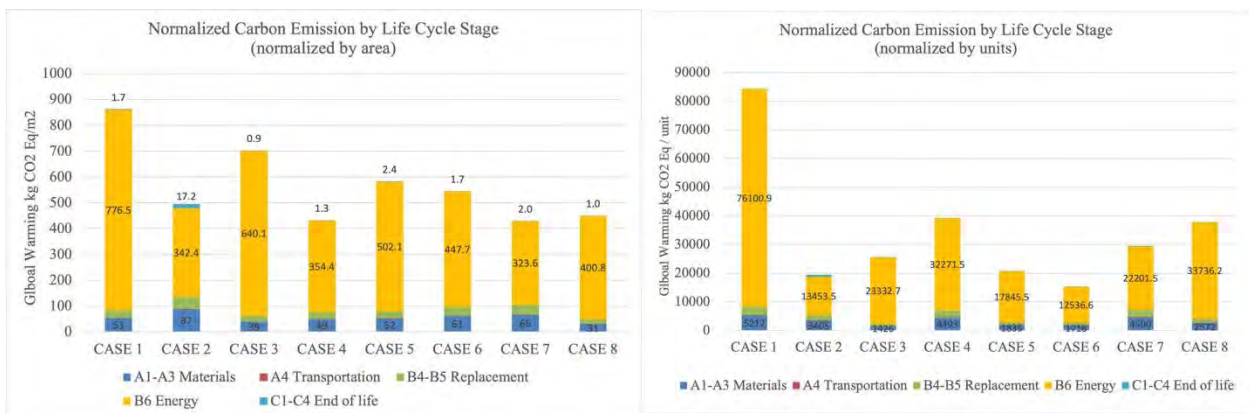

Figure 2 Normalized carbon emissions by life cycle stage

As illustrated in Figure 3, for embodied carbon, case 1 has the highest increase per floor area, followed by case 2 and case 6. For the offset embodied carbon through an operating energy reduction, case 2 has the highest life cycle carbon reduction followed by case 1 and case 7. Regarding the balance between a carbon increase and offset, all case buildings have negative life cycle carbon, which is an indicator that an energy retrofit is effective in reducing the life cycle carbon emissions of existing buildings. However, if we only look at the offset carbon emissions through an operating energy use reduction, case 1 ranks first, followed by cases 2 and 6. Despite the highest life cycle carbon emissions (refer to Figure 2), as showed in Figure 3, case 1 has the highest life cycle carbon reduction compared to the base condition before the energy retrofit. These different ranking results illustrate how evaluating sustainability using different portions of the life cycle of carbon can have different results, hence the decisions based on the analysis results may vary.

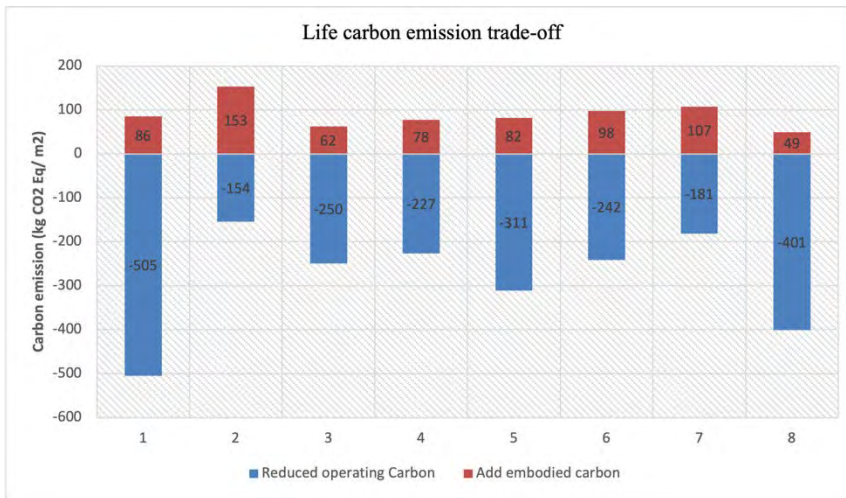

Figure 3: Life cycle carbon emissions trade-off

3.2 Embodied carbon: building materials and systems

A1–A3 has the second highest life cycle stage contributing to life cycle emissions; this contribution is mostly related to the selection and production of building materials, components, and systems. Then, we look at the life cycle carbon derived from building materials and systems during the production and construction life stages. Figure 4a shows normalized carbon emissions (per floor area) during A1–A5 stages, which we defined as embodied carbon. The external wall is the dominant category contributing to embodied carbon, and the elevator core ranked second. The only outlier is case 2, where the elevator and roofing systems are main contributors to the added embodied carbon. Figure 4b shows that the results of normalized carbon by unit counts are different: case 1 ranks first with the highest per unit carbon emissions from building systems and materials used for the energy retrofit, followed by case 7 and case 4. Again, these different results demonstrate the need to potentially use occupants or unit counts as a normalization unit.

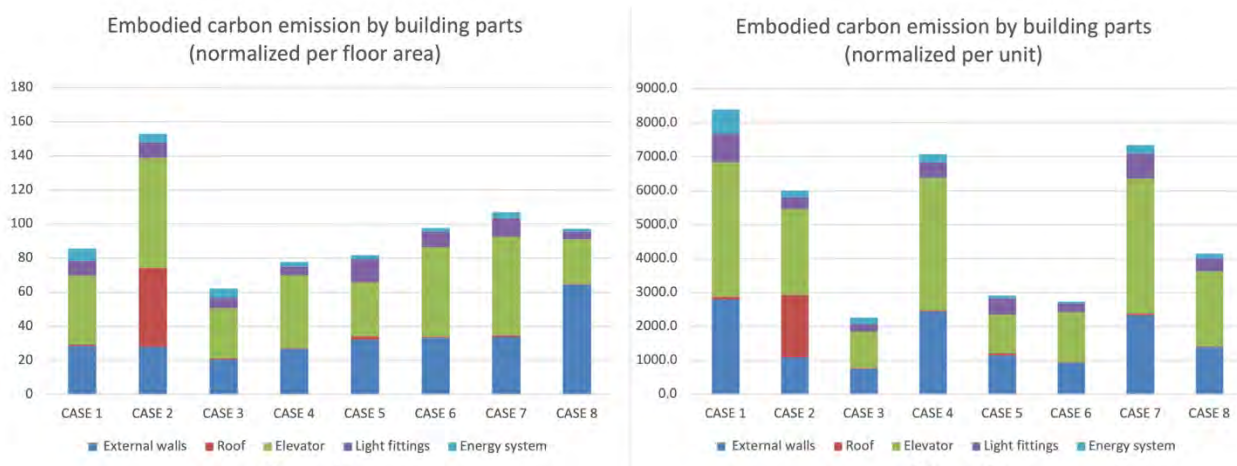

Figure 4a

Figure 4b

Figure 4 Embodied carbon emissions by elements

3.3 Sustainability index calculation and visualization

The sustainability score is first calculated using equally weighted OES, EMB, and ECO. As illustrated in Figure 5, the X-axis represents the sustainability score (unitless), and the Y-axis is the energy use intensity after renovation, measured in kWh/m². The size of the bubble represents the total floor area of the case building, measured in m². For example, case 8 has a gross floor area of 6060 m², represented by the biggest circle. In general, the higher the sustainability score, the less the overall life cycle carbon emissions emitted from the renovated building, hence the more sustainable the building.

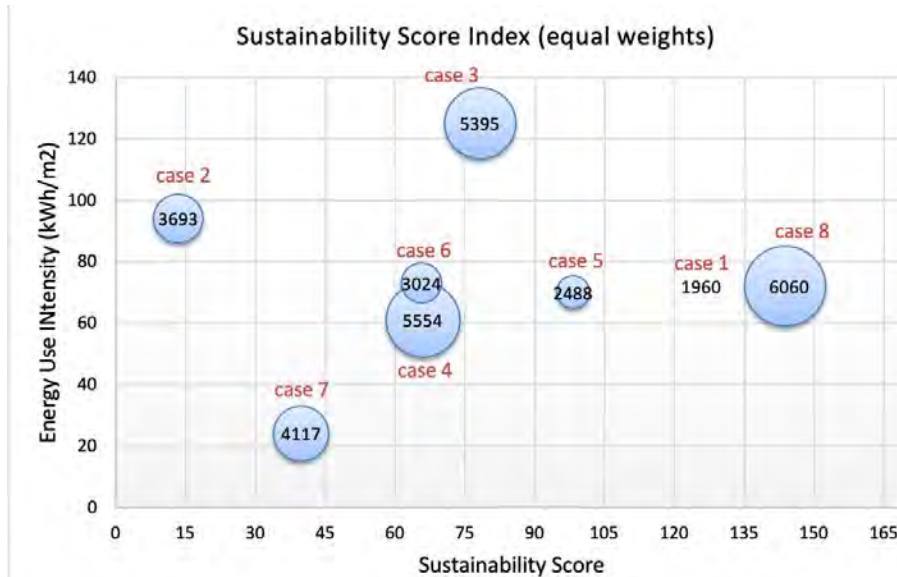

Figure 5 Sustainability score

Figure 5 demonstrates two important findings. First, size is not correlated with the sustainability score, as the largest building (case 8) and the smallest building (case 1) have similar sustainability scores that are extremely different from the other cases. Second, energy use intensity (EUI) might not be a good measure of sustainability. In current practice, EUI is often used to measure the energy efficiency of the building and consequently the sustainability of the building. If EUI is a good indicator of sustainability, then the EUI (Y-axis) and sustainability score (X-axis) would be negatively correlated. However, they do not appear to have a clear correlation. For instance, case 7 has the lowest EUI but also the lowest sustainability score. This can be explained by the trade-off between reduced carbon emissions and increased embodied carbon. To summarize, case 2 has the highest embodied emissions increase with the second lowest operating carbon reduction. Therefore, low EUI does not necessarily mean more sustainability. In addition, case 3 has the highest EUI after renovation, which may indicate that case 3 still has much space to improve the current energy performance. However, case 3 also has the third highest sustainability score due to its poor previous energy performance followed by a large operating energy reduction achieved through the renovation. Therefore, the added embodied carbon (from the renovation) is well adjusted by the large offset of an operating carbon reduction.

The proposed sustainability score can provide us with a more comprehensive understanding of how sustainable the renovation works are from a life cycle carbon emissions perspective, providing a more robust estimation of global warming potential related to building renovation. Only focusing on the operating energy may provide an incomplete, sometimes even opposite, interpretation to measure the effectiveness of a building energy retrofit, which is clearly demonstrated in case 7. Case 7 has the lowest energy use intensity after renovation. Based on the current commonly used measurements and criteria, it is considered very energy efficient and even has the potential to achieve net zero energy if there are renewal energy sources onsite, such as solar or wind energy. However, case 7 ranked the second lowest for the proposed sustainability score, mainly due to the trade-off between added embodied energy and reduced operating energy. From a long-term perspective, case 7 can produce more life cycle carbon than the other cases, and a large portion of such emissions are embedded in the building materials, components, and systems used in the renovation.

4.0. CONCLUSION

This study investigates the trade-off between a reduced operational carbon reduction and added embodied carbon emissions of eight deep energy retrofit projects. The case buildings' analysis demonstrated that the current practice, which focuses solely on an operational energy use reduction, may not result in the most sustainable solution if the embodied energy and related carbon emissions are not carefully counted. Moreover, using the proposed sustainability index, integrating both operational carbon and embodied carbon, we found that the large operating energy reduction

can be offset by the added embodied energy, and the renovated building with the lowest EUI can be less sustainable than those buildings with higher EUIs. In addition, this study revealed that the sustainability score varies based on stakeholders' perspectives. If embodied carbon emissions are not included in the consideration of energy retrofit planning, it is impossible for building owners to reduce the additional emissions once the renovation is finished. Consequently, addressing embodied carbon emissions should go hand in hand with deep operating energy retrofit initiatives to achieve a comprehensive sustainable result. In the future, we recommend that embodied carbon be included in building codes and regulations and that it be used together with EUI to measure the effectiveness of a building energy retrofit.

ACKNOWLEDGEMENTS

Finland Fulbright Foundation provided funding to this project. I thank School of Architecture, Planning and Preservation at University of Maryland, Faculty of Built Environment, Tampere University and VTT Technical Research Centre of Finland for their support.

REFERENCES

- Bakar, Nur Najihah Abu, Mohammad Yusri Hassan, Hayati Abdullah, Hasimah Abdul Rahman, Md Pauzi Abdullah, Faridah Hussin, and Masilah Bandi. "Energy efficiency index as an indicator for measuring building energy performance: A review." *Renewable and Sustainable Energy Reviews* 44 (2015): 1-11.
- Crawford, Robert H., Isabella Czerniakowski, and Robert J. Fuller. "A comprehensive framework for assessing the life-cycle energy of building construction assemblies." *Architectural science review* 53, no. 3 (2010): 288-296.
- EUGUGLE. "Project description." Accessed May 24, 2021. <http://eu-gugle.eu/project/>
- EU-GUGLE "A sustainable renovation pilot project for smarter cities." Accessed May 24, 2021. <https://www.eurac.edu/en/research/technologies/renewableenergy/conferences/Documents/4.%20Morishita%20Naomi.pdf>
- Hirvonen, Janne, Juha Jokisalo, Juhani Heljo, and Risto Kosonen. "Towards the EU emissions targets of 2050: Optimal energy renovation measures of Finnish apartment buildings." *International Journal of Sustainable Energy* 38, no. 7 (2019): 649-672.
- Jiménez-González, Concepción, Alan D. Curzons, David JC Constable, and Virginia L. Cunningham. "Cradle-to-gate life cycle inventory and assessment of pharmaceutical compounds." *The International Journal of Life Cycle Assessment* 9, no. 2 (2004): 114-121.
- Moran, Paul, John O'Connell, and Jamie Goggins. "Sustainable energy efficiency retrofits as residential buildings move towards nearly zero energy building (NZEB) standards." *Energy and Buildings* 211 (2020): 109816.
- Niemelä, Tuomo, Risto Kosonen, and Juha Jokisalo. "Cost-effectiveness of energy performance renovation measures in Finnish brick apartment buildings." *Energy and Buildings* 137 (2017): 60-75.
- Petrovic, Bojana, Jonn Are Myhren, Xingxing Zhang, Marita Wallhagen, and Ola Eriksson. "Life cycle assessment of building materials for a single-family house in Sweden." *Energy Procedia* 158 (2019): 3547-3552.
- Rosselló-Batle, Beatriz, Carlos Ribas, Andreu Moià-Pol, and Víctor Martínez-Moll. "An assessment of the relationship between embodied and thermal energy demands in dwellings in a Mediterranean climate." *Energy and Buildings* 109 (2015): 230-244.
- Stephan, André, Robert H. Crawford, and Kristel De Myttenaere. "A comprehensive assessment of the life cycle energy demand of passive houses." *Applied energy* 112 (2013): 23-34.
- Triana, Maria Andrea, Roberto Lamberts, and Paola Sassi. "Sustainable energy performance in Brazilian social housing: A proposal for a Sustainability Index in the energy life cycle considering climate change." *Energy and Buildings* 242 (2021): 110845.
- Venkatraj, Varusha, Manish Kumar Dixit, Wei Yan, and Sarel Lavy. "Evaluating the impact of operating energy reduction measures on embodied energy." *Energy and Buildings* 226 (2020): 110340.

Strategies for Redesigning High Performance FRP Wind Blades as Future Electrical Infrastructure

Tristan Al-Haddad¹, Ammar Alshannaq¹, Lawrence Bank¹, Mehmet Bermek¹, Russell Gentry¹, Yulizza Henao-Barragan¹, Sean Li¹, Alex Poff¹, John Respert¹, Colin Woodham¹

Georgia Institute of Technology, Atlanta, GA

ABSTRACT: Wind capture is one of the best forms of renewable energy generation and is growing both on and offshore at a staggering pace world-wide. One of the major challenges however is what to do with the Fiber Reinforced Composite blades that drive the turbines at the end of service life which is typically only 20 years. Working with colleagues at Queen's University Belfast (Northern Ireland) and University College Cork (Republic of Ireland), The Re-Wind Team at Georgia Tech has developed a patented re-use application for deploying the end-of-life blades as the vertical tower structures in future high voltage electrical transmission lines thus contributing to the circular economy. The US electrical grid will undergo trillions of dollars' worth of expansion and improvements over the next two decades. By reusing the blades to replace virgin materials such as steel and concrete within the electrical grid, this design will not only avoid landfilling millions of tons of composite material it will also reduce the overall carbon footprint of future grid construction.

KEYWORDS: Global Sustainability, Mitigation and Adaptation, Materials and Advanced Digital Fabrication, Circular Economies, Future Electric Grid, Power Transmission, Resilient Infrastructure, Economic Sustainability

INTRODUCTION

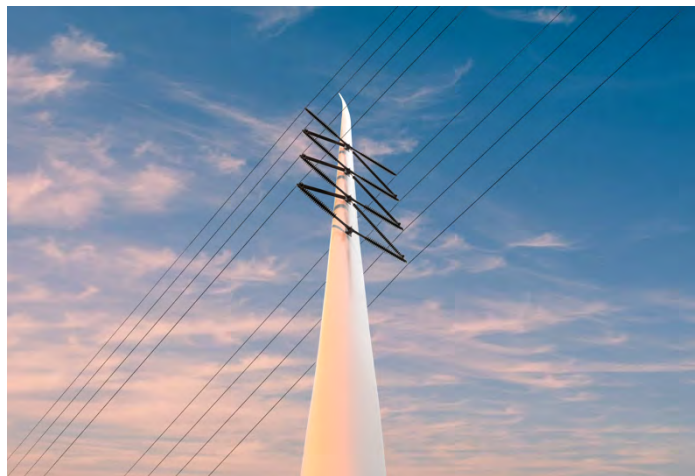

Figure 1: Detail of BladePole with Braced Line Post Hardware

From humble beginnings turning mills and pumps in the lowlands of Northern Europe wind power has become one of the highest output forms of renewable energy in the world with an estimated 192 GW of installed capacity in 2020 and an estimated 15-18% of global electricity production projected by 2050 (Lui et al 2017). While this energy is clean and renewable it does have at least one major hurdle to overcome which is what to do with the end-of-life (EoL) fiber reinforced polymer blades that harvest the wind and turn the turbines to generate electricity. The Re-Wind network is a group of engineers, architects, geographers and policy researchers in the USA, Ireland, and Northern Ireland that have been developing multiple technologies and applications for second life reuse of these high value blades within a circular economy paradigm. In addition to the primary application discussed in this paper, The BladePole (Figures 1 & 2), the team has developed

a suite of reuse applications as a *Design Atlas* to guide the community as we tackle this issue for decades to come. The applications include pedestrian bridges, seawall barriers, and affordable housing to name a few.

1.0 PROBLEM: End-of-Life (EoL) Wind Blade Waste is A Looming Disaster

1.1 Context

The wind energy system follows a linear economy where raw materials are extracted to manufacture wind turbines, these are used and maintained for approximately 20-25 years and finally deemed for decommissioning or repowering (WindEurope 2020). Wind power is considered a renewable energy source because it uses the wind to generate energy and therefore it does not emit greenhouse gas emissions during its use phase. Additionally, the wind industry continues to focus its efforts to improve the manufacturing process of wind turbine production and all of the components. Unfortunately, the wind energy industry currently does not fully implement a circular economy model where 100% of the components are recirculated at end-of-life, a so-called cradle to cradle approach.

When a wind turbine is deemed for repowering or decommissioning, 85%-90% of the total mass of the turbine can be recycled like the foundation, tower, gearbox, and generator mainly because these are composed of steel and concrete materials that are traditionally used and have standard recycling processes in place (WindEurope 2020). However, wind turbine blades are composites made of carbon or glass fiber, a polymer matrix, balsa wood or foams, structural adhesives, and coatings that make it very difficult and energy intensive to separate (Jensen and Skelton 2018). Therefore, when wind turbines come out of service, blades are typically landfilled or incinerated (Bloomberg 2020).

1.2 Decommissioning and Repowering

In the United States, the terms decommissioning and repowering are distinguishable in wind energy. When a wind turbine is deemed for repowering, it is understood that everything but the tower is replaced to improve the wind turbine efficiency with new technology (Bank et al. 2021). This happens when new and improved technology in wind energy is available, and the benefits outweigh keeping the old turbine in place. Additionally, tax benefits could potentially expedite the decision to repower much earlier than the original projected decommissioning date of the system, sometimes even when the system has not been used for half of its expected life span. On the other hand, decommissioning efforts focus on removing the entire wind turbine from the foundation up. The methods used for removing the elements vary from taking them down with care for potential resale opportunities, to taking the wind turbine down from the base then cutting it in place and shipping to landfill, incineration, or recycling facilities. However, most of the blades are abandoned in place, especially the ones from the first generation of wind farms, or decommissioning contractors are stockpiling them for prospective future use in cost-effective recycling processes (Bank et al. 2021). Currently, when it comes to wind energy, the major concern is the next step with what to do with the stockpiling of blades.

1.3. Blade Waste

Very recently, blades are starting to be designed with recycled capabilities (Siemens Gamesa 2021), and these have been developed for offshore applications. This could be a potential solution when these blades reach their end-of-life. However, current blade waste is being accumulated on site which are the blades coming out of service from the first wind farms installed in the late 1990s and early 2000s. At least 20,000,000 tons (44,000,000,000 pounds) is expected to be the accumulated decommissioned blade waste in the world by 2050 (Liu and Barlow 2017) with the United States contributing 2,200,000 tons of this blade waste by 2050 as well (Cooperman 2021).

1.4. Current End-of-Life Processes

Current end-of-life procedures involve sending the cut sections of wind blade for landfilling (Bloomberg 2020), incineration for energy recovery (EPRI 2018), and recycling practices. The recycling practices have been implemented as end-of-life mechanisms to recover part of the raw materials in the composite wind blade through mechanical, chemical, or thermal recycling. These recycling practices begin by mechanically crushing, grinding, and shredding the blades (EPRI 2018); consequently, they involve processes like pyrolysis to recover fiber, char, and gasses for energy (EPRI 2020), solvolysis to recover high-quality glass and carbon fibers, cement kiln co-processing to recover cement raw materials, and mechanical processing to convert into pellets, needles, fine filler, and fiber retention (Bennet et al. 2021). However, these processes typically reduce the value of the material and miss the potential economic advantage of repurposing the blade as a whole or with minimal modifications.

Additional end-of-life applications include repurposing by resizing and reshaping the element which will result in high value end products (Jensen and Skelton 2018). However, it is still difficult to provide a standardized procedure to the new end product in contrast with the conventional product that it is trying to replace. In other words, for the repurposed second life product to compete with conventional ones, clear standards and documentation are required for universal application. Previous research has investigated wind turbine blade geometry and internal structure and developed a workflow to identify and optimize airfoil curves from a point-cloud model of a blade (Tasistro-Hart et al. 2019). Based on the blade's cross section and the multiple potential segment cuts possible, previous literature presents repurposing solutions to use decommissioned wind turbine blades as foundations, doors, window covers and even roof frames (Bank et al. 2018). For larger element sizes, conceptual research has focused on repurposing blades as horizontal support beams for bridges (Andre et al. 2020). Additionally, a deeper structural analysis has been performed for blades used as vertical cantilever structures used for energy transmission (Alshannaq et al. 2021). Therefore, this paper aims to provide clear documentation on how blades repurposed as energy transmission poles can increase resiliency both in the waste stream and in the energy transmission sector, especially in coastal cities.

2.0 NEED: The Future Electrical Grid Must Be Built

2.1 Power Transmission Networks in 2050

According to the American Society of Civil Engineers (ASCE) *Infrastructure Report Card 2021* the United States received a 'C-' on its last evaluation. The US power transmission and distribution system, T&D, has been neglected for decades, has not kept up with demand, and has become exponentially more vulnerable to weather related outages due to the extreme weather events caused by climate change. In 2011 The Electrical Power Research Institute, EPRI, estimated that the grid was in need of approximately \$400 billion worth of upgrades in order to return more than \$1.2 trillion worth of societal benefits.

The future grid must be designed for a planet that is undergoing extreme shifts due to climate change. *High Intensity Low Frequency* (HILF) events will dictate structural requirements in many regions, especially on the coast. The design service loads of all the primary and secondary load carrying structures will need to be significantly increased to resist the increased loads that are projected from these HILF's. According to Professor Massoud Amin at the University of Minnesota the total number of grid outages more than doubled in a decade from 107 outages between 1991-1995 to 232 outages between 2001-2005 (Amin 2008). The majority of these outages were caused by weather events.

Additionally, the demand on the grid continues to increase year over year due to causes such as increased remote work scenarios, population growth, and increased distributed power generation through renewable technologies such as wind power and solar (Graham et al. 2017). All of these issues are well known yet still have not been properly addressed. The looming explosion of demand on the grid that is coming with the electric vehicle revolution will exacerbate the problem even further (Bowermaster 2018).

3.0 SOLUTION: Wind Blade Reuse as Future Electrical Infrastructure



Figure 2: BladePole as a series of straight run *Tangent Poles* in a double circuit 230 KV transmission line

3.1 BladePole Concept and Affordances: Cheaper, Faster, Better

One of the most promising second life blade applications is the *BladePole* Concept (Patent Filing: WO2021/026198A1) which takes EoL blades and uses them as the vertical structure in electrical transmission grids replacing costly and high embodied energy structures. After being decommissioned by the wind farm owner the blades become a significant reclaimed material resource for infrastructural construction projects, we think of it as *The New Forest*. For the purposes of this applied research project the team is focused on reuse of the blades as the vertical tangent poles for 230 KiloVolt (KV) transmission lines and we use the loading requirements and costs for these systems as the basis for analysis and comparison.

3.2 The Three E's of BladePole: Ecology, Economics, and Engineering

The *BladePole* affordances can be classified by their ecological, economic, and engineering potential. From an ecological perspective the reuse of wind turbine blades as high-performance utility poles provides a significant avoided carbon cost by eliminating the use of virgin materials such as steel lattice towers, heavy gauge steel monopoles and rotomolded ferro-cement poles as the tower component of the structure. Future research may even allow for direct burial foundations, in which case all virgin materials would be avoided in the structure as there would be no need for a concrete foundation. If all decommissioned blades were repurposed as *BladePoles*, or other second life applications, the United States would reduce its total landfill usage by more than one percent by volume (Cooperman 2021) which is an enormous amount of waste that would be kept out of Earth's fragile crust.

As promising as the ecological affordances are, material conservation and landfill constraints alone are not enough to motivate blade reuse at scale. There must also be an economic motivator to truly solve this problem (Cooperman 2021). The highest and best reuse value of wind blades resides in reusing the whole blade as a large, high-cost structure rather than reprocessing it for smaller sections or even worse, shredding or burning the blade for silica recapture and small amounts of fuel (Bank et al. 2021). According to the transmission and distribution non-profit MISO (Midcontinent Independent System Operator) the average cost of a 230KV steel monopole for double circuit tangent poles was approximately \$40,000 per pole in 2019. The average number of poles per mile of transmission line is five. Therefore, simply based on an apples-to-apples comparison of a 200-mile transmission line the *BladePole* approach would save utility companies and their customers, \$40,000,000 on a single project alone (MISO MTEP19). Those

savings could be reinvested in additional renewable energy assets to reduce the carbon offset of BladePole even further. Therefore, BladePole creates a strong sustainable business model for decades of reuse projects as the grid is rebuilt and expanded.

Lastly, due to the fact that the blades were originally designed for incredibly high dynamic loading in flexure, similar to an airplane wing, these FRP structures have many times greater load carrying capacity than is required by the design service loads of a typical 230KV tangent pole. As compared to a single circuit transmission line with steel monopoles at a 1,000-foot spacing the BladePole has a safety factor 6.2 times greater than the design service load that is required (Alshannaq et al. 2021a). This, along with the fact that the blades are non-corrosive and non-conductive, makes them incredibly durable and resilient when deployed in high population coastal areas that have historically experienced HILF weather events and that are also subject to accelerated corrosion due to airborne sea salts. This level of improved performance would normally increase capital costs but in this case, it is a cost savings.

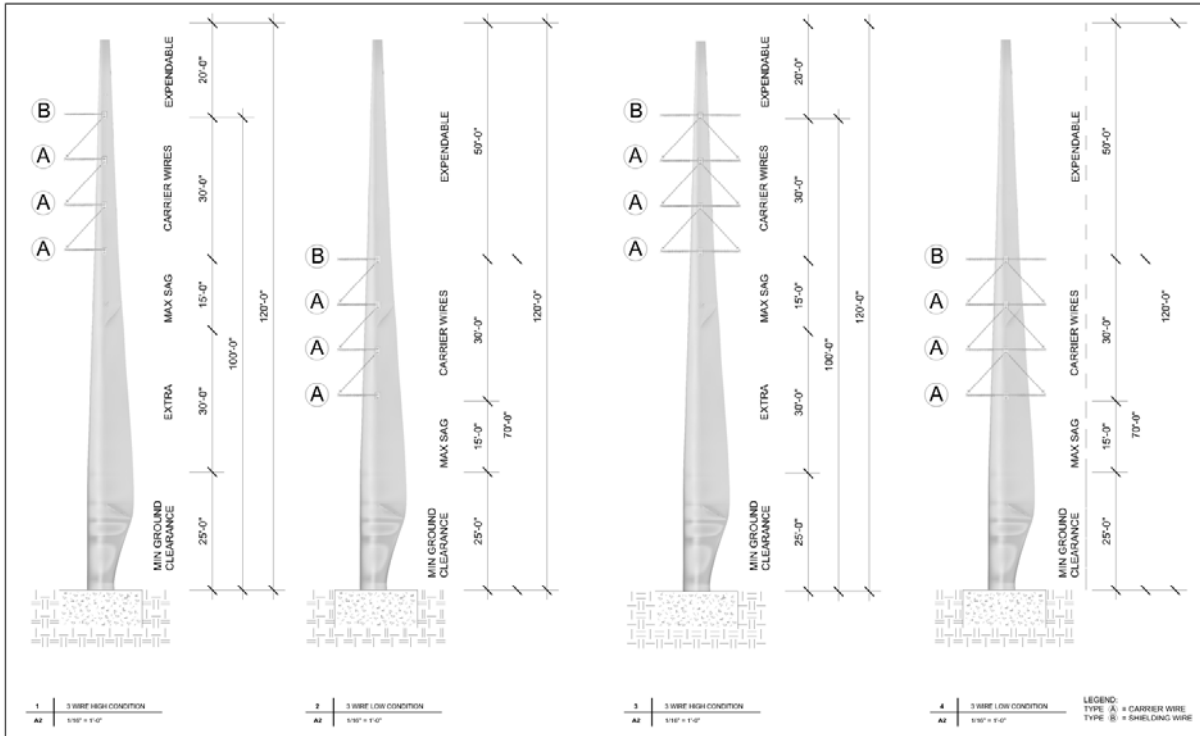

Figure 3: BladePole showing various configurations of hardware height (min and max) and wire groupings

3.3 Blade Machine: Computational Forensics

For architects and engineers to design for second life applications we must have a method of representing the blades accurately for use in design drawings, engineering analysis, fabrication processes and logistical planning. The Re-Wind team has developed a four-part computational forensics technology for capturing blade geometry as a 'Digital Twin' with various levels of fidelity and attribute richness (Tasistro-Hart et al. 2019, Kiernicki et al. 2021). This technology is referred to as the 'Blade Machine' and it produces a data rich digital model for each blade type. First the existing blade is laser scanned which yields a point cloud model. This point cloud model is then 'reprocessed' through a best fit algorithm by comparing the results of the scan to a public airfoil database (Figure 4). After the search algorithm has identified the best fit airfoils, the system automatically constructs a new surface geometry model using a visual programming environment (Figure 5). From there, the 'thin' surface geometry can be 'thickened' to represent the internal composition and materiality of the blade. The Blade Machine is an enabling technology for the BladePole application.

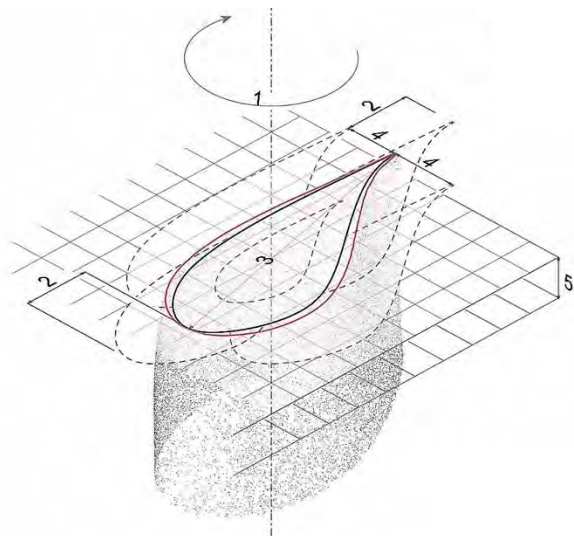

Figure 4: Blade Machine analyzing point cloud scan looking for best fit airfoils from database. Author: Tasistro-Hart 2019

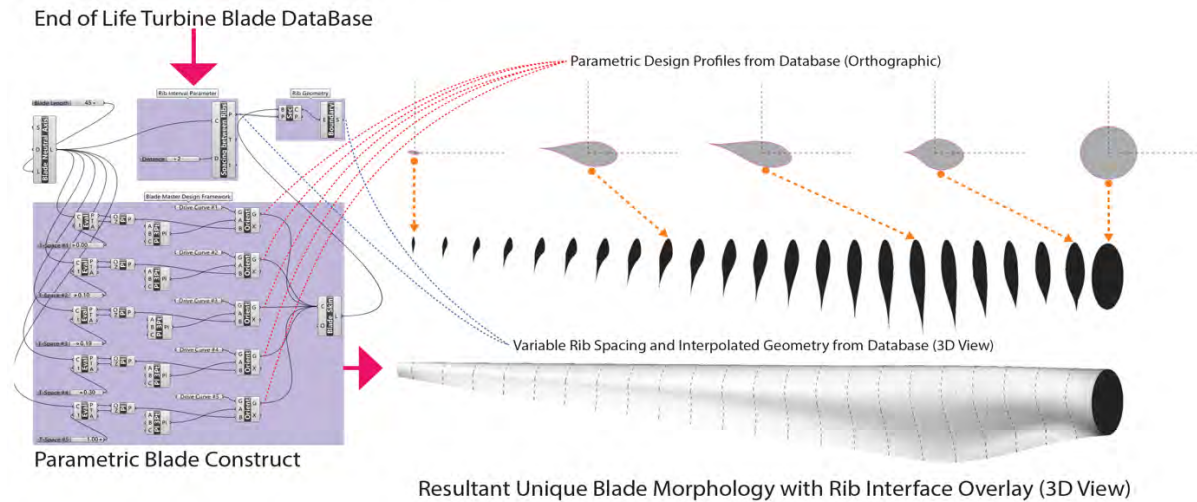

Figure 5: Blade Machine constructing a new model of the blade's *Digital Twin* as a NURBS surface

3.4 Universal Connector and Parametric Adaptation

One of the most challenging aspects of any FRP blade reuse project is developing methods to connect other non-blade components to the blade structure. The BladePole team has developed the *Universal Connector* (UC) and a method of installation which allows for the attachment and structural transfer of forces into the spar cap of the blade through a custom steel fixture (Figure 6). The spar cap is the main load carrying component of a wind blade and is composed of solid FRP (Alshannaq et al. 2021b). Having this UC allows for the usage of standard transmission line hardware such as braced line posts or davits for wire carrying functions. The UC is composed of five steel pieces of various gauges that have been waterjet cut and welded together. More specifically, the UC pieces consist of a Base Plate, Web, Hanger, and two Stiffeners. Each UC is attached to the BladePole by 6 blind bolts that connect the UC Base Plate directly to the face of the spar cap, see Section 4. The blind bolt attachment method is paramount since access to the interior of the blade is impractical. Aligned along the centerline of the spar cap, the UC ensures maximum rigidity as it carries the loads of the braced line hardware and transmission lines. By utilizing parametric adaptations, the UC can accurately mate to the curvature of any processed Blade Machine geometry. Subsequently, the curvature of the UC Base Plate is automatically adjusted by the Blade Machine to the geometry of the blade and the stiffeners will adapt by remaining perpendicular to the centerline of the spar cap. Parametric adaptation also allows the location and diameter of receiving holes in the UC Web to be adjusted to match various hole patterns for different hardware types. Collectively these functions can automatically create machining files from the parametric model for fabrication tasks.

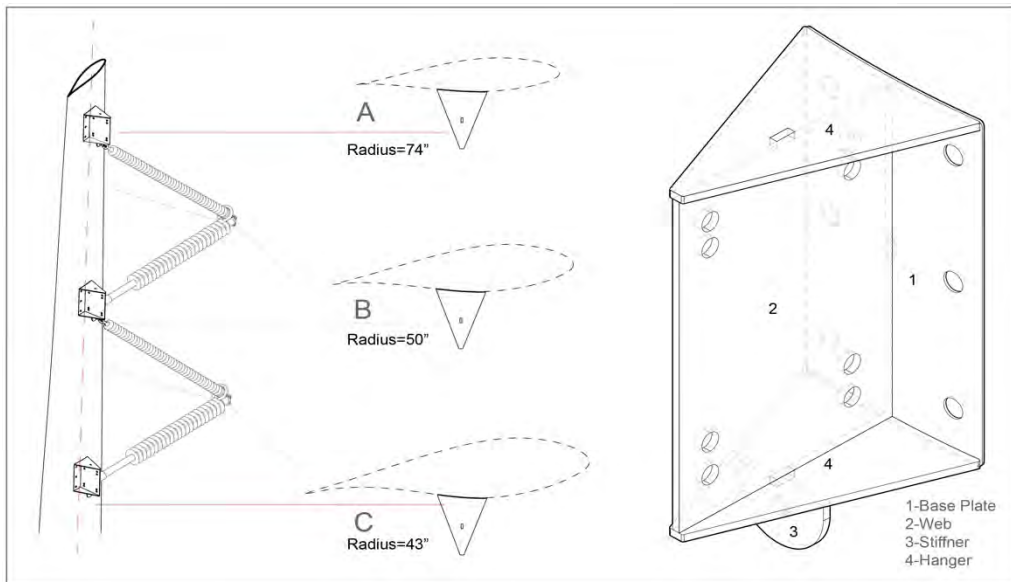

Figure 6: The Universal Connector (UC) is a steel fixture that allows attachment points to the FRP spar cap for various structural functions and automatically adjusts to the blade's local curvature in the Blade Machine model

3.5 Construction Logistics

The onsite construction sequence of the BladePole consists of eight primary steps (Figure 7). Step number one requires excavation of the site with a backhoe. These will be where the concrete mat foundations will be poured. Once the foundations have cured the blades are delivered by flatbed trucks and laid out onsite by a small crane. Next any damage to the blade is assessed, manually repaired and then the blade is painted. The UC hardware is also installed during this step. The blade is then erected by a crane and lifted onto the concrete foundation. Next the braced line post hardware is installed on each blade with the use of an articulating lift. Finally, the transmission wires are installed across each blade, in some cases as a single circuit on one side only and in other cases as a double circuit with transmission lines running on both sides of the blade as seen in Figure 7.

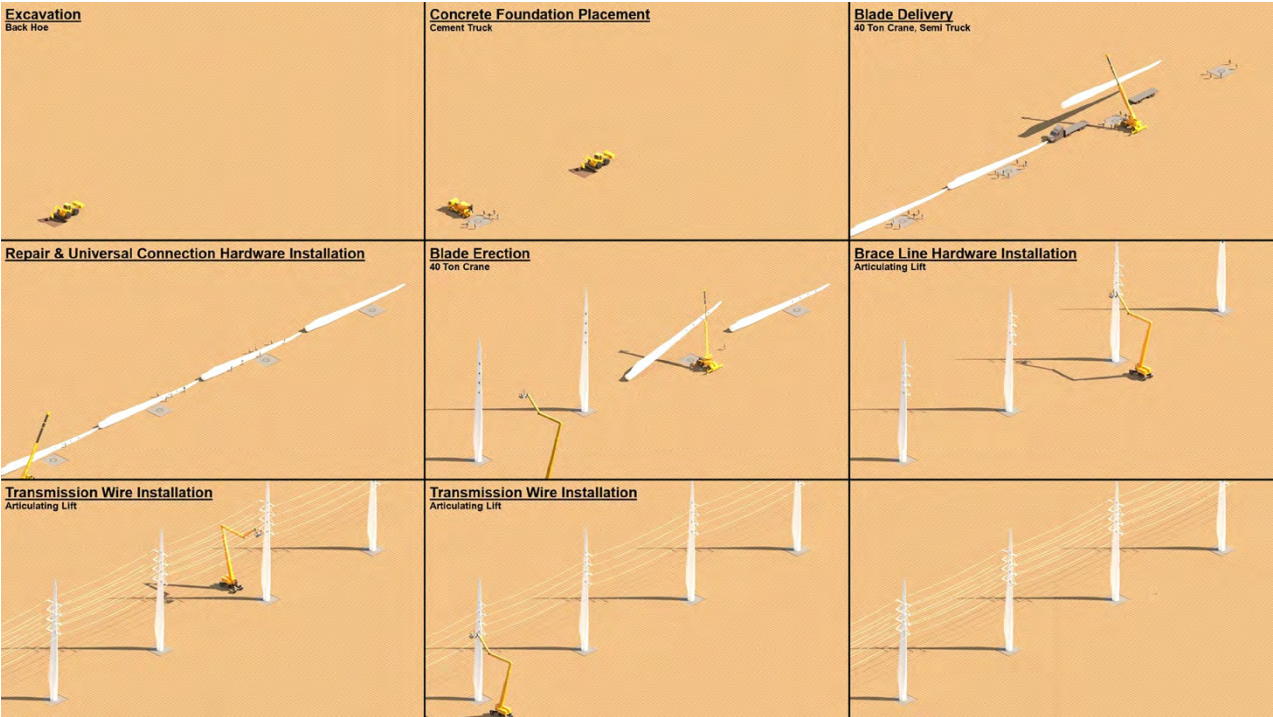

Figure 7: BladePole construction sequence in the field: 1) Excavation of site, 2) Concrete foundations are placed, 3) Blades are delivered, 4) Blade repairs are made and UC’s are installed, 5) Blade erection with small crane, 6) Braced Line Post Hardware is installed, 7) Transmission wires are installed on first side, 8) Transmission wires are installed opposite side

4.0 VALIDATION: Experimental Proof of Concept

4.1. Making, Mocking, and Breaking in the Digital Fabrication Laboratory



Figure 8: Decommissioned blades delivered to the lab



Figure 9: Large sections are cut into smaller test specimen

To test the feasibility of the BladePole the team has constructed a full-scale demonstration in the Digital Fabrication Laboratory at the Georgia Tech School of Architecture (Figures 8-15). After design and engineering work was completed, a decommissioned blade was delivered by flatbed truck and cut into sections. As the blade was being sectioned, the Universal Connector (UC) was fabricated from the parametric model using



Figure 10: Steel is formed to fit blade curvature



Figure 11: Steel plates are CNC waterjet cut and MIG welded to create the final UC

a CNC waterjet. The UC is constructed from 5 pieces of mild steel (11ga and 3/8") that are welded together to form the final UC component. The side that bolts to the BladePole itself is bump formed along precut guides to fit the radius to ensure proper load transfer from the UC to the spar cap. Approximately 12 of the UC's were fabricated, some for the final mockup and others for engineering testing. On the 20 foot tall section of blade used for the mockup, centerlines were drawn down the spar cap and holes were laid out with a template. These holes are where the UC connectors will finally be mounted with blind bolt hardware.

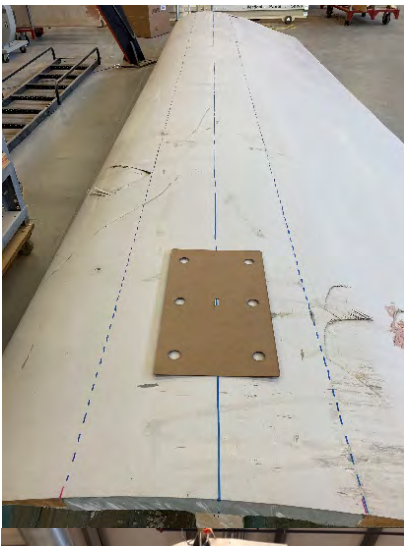

Figure 12: Hole layout and prep for drilling



Figure 13: Drilling of hardware holes with diamond saw

In order to account for the taper of the blade and put the centerline of the leading edge on the horizontal, the blade was rested on wooden shims. The line was marked with masking tape and cut flat. The blind bolt holes are cut using a diamond tipped hole saw and a handheld drill. Once the layout and hole drilling work was complete the UC hardware and braced line post hardware was installed and the blade was erected vertically using a forklift and boom.

CONCLUSION

By identifying high value practical infrastructure needs and mapping the affordances of the existing stock of FRP wind blades we will be able to develop sustainable, ie resilient, design and development models to support second life circular economies for the reuse of wind wind blades. Future work for this project will include full-scale structural load tests of the BladePole and a full-scale demonstration project in 2022.



Figure 14: UC and Braced Line Post hardware is completely installed and blade is erected in the lab awaiting a full-scale structural test



Figure 15: UC and Braced Line Post hardware is completely installed and blade is erected in the lab awaiting a full-scale structural test

ACKNOWLEDGEMENTS

This work was initiated under the auspices of a US-Ireland Tripartite Project funded by the U.S. National Science Foundation (NSF) under grants 1701413 and 1701694 with follow-on funding from the NSF Partnership for Innovation Fund under grant 2016409.

REFERENCES

- Alshannaq, Ammar A., Lawrence C. Bank, David W. Scott, and Russell Gentry. 2021a. "A Decommissioned Wind Blade as a Second-Life Construction Material for a Transmission Pole." *Construction Materials* 1 (2): 95–104. <https://doi.org/10.3390/constrmater1020007>.
- Alshannaq, Ammar A., Lawrence C. Bank, David W. Scott, and T. Russell Gentry. 2021b. "Structural Analysis of a Wind Turbine Blade Repurposed as an Electrical Transmission Pole." *Journal of Composites for Construction* 25 (4): (ASCE)CC.1943-5614.0001136, 04021023. [https://doi.org/10.1061/\(ASCE\)CC.1943-5614.0001136](https://doi.org/10.1061/(ASCE)CC.1943-5614.0001136).
- American Society of Civil Engineers. (2021). *2021 Infrastructure Report Card*. <https://infrastructurereportcard.org/category/energy/>
- Amin, Massoud. 2008. "Challenges in reliability, security, efficiency, and resilience of energy infrastructure: Toward smart self-healing electric power grid," 2008 IEEE Power and Energy Society General Meeting - Conversion and Delivery of Electrical Energy in the 21st Century, 2008, pp. 1-5, doi: 10.1109/PES.2008.4596791.
- André, A., J. Kullberg, D. Nygren, C. Mattsson, G. Nedev, and R. Haghani. 2020. "Re-Use of Wind Turbine Blade for Construction and Infrastructure Applications." *IOP Conference Series: Materials Science and Engineering* 942 (October): 012015. <https://doi.org/10.1088/1757-899X/942/1/012015>.
- Bank, Lawrence C., Franco R. Arias, Ardavan Yazdanbakhsh, T. Russell Gentry, Tristan Al-Haddad, Jian-Fei Chen, and Ruth Morrow. 2018. "Concepts for Reusing Composite Materials from Decommissioned Wind Turbine Blades in Affordable Housing." *Recycling* 3 (1): 3. <https://doi.org/10.3390/recycling3010003>.
- Bank, Lawrence C., Emma L. Delaney, Jennifer McKinley, Russell Gentry, and Paul G. Leahy. 2021. "Defining the Landscape for Wind Blades at the End of Service Life." *Composites World*. 2021. <https://www.compositesworld.com/articles/defining-the-landscape-for-wind-blades-at-the-end-of-service-life>.
- Bennet, Lorna, Jeff Hailey, Pamela Lomoro, Annabel Fitzgerald, Jonathan Fuller, James Lightfoot, Anne Velenturf, and Krasimira Trifonova. 2021. *SUSTAINABLE DECOMMISSIONING: WIND TURBINE BLADE RECYCLING REPORT*. <https://doi.org/10.13140/RG.2.2.15202.86723>.
- Bloomberg.Com. 2020. "Wind Turbine Blades Can't Be Recycled, So They're Piling Up in Landfills," February 5, 2020. <https://www.bloomberg.com/news/features/2020-02-05/wind-turbine-blades-can-t-be-recycled-so-they-re-piling-up-in-landfills>.
- Bowermaster, Dan. 2018. "It's Time to Prepare The Grid for the Longhaul." *EPRI Journal, November/December 2018*, 34. Palo Alto: EPRI.
- Cooperman, Aubryn, Annika Eberle, and Eric Lantz. 2021. "Wind Turbine Blade Material in the United States: Quantities, Costs, and End-of-Life Options." *Resources, Conservation and Recycling* 168: 105439.
- EPRI. 2018. "End-of-Life Disposal and Recycling Options for Wind Turbine Blades." <https://www.epri.com/research/products/3002012240>.
- EPRI. 2020. "Wind Turbine Blade Recycling: Preliminary Assessment." <https://www.epri.com/research/products/000000003002017711>.
- Gentry, T. Russell, Tristan Al-Haddad, Lawrence C. Bank, Franco R. Arias, Angela Nagle, and Paul Leahy. 2020. "Structural Analysis of a Roof Extracted from a Wind Turbine Blade." *Journal of Architectural Engineering* 26 (4): 04020040. [https://doi.org/10.1061/\(ASCE\)AE.1943-5568.0000440](https://doi.org/10.1061/(ASCE)AE.1943-5568.0000440).
- Graham, Robert, Julieta Francis, and Richard Bogacz. 2017. *Challenges and Opportunities of Grid Modernization and Electric Transportation*. US Department of Energy
- Jensen, J.P., and K. Skelton. 2018. "Wind Turbine Blade Recycling: Experiences, Challenges and Possibilities in a Circular Economy." *Renewable and Sustainable Energy Reviews* 97 (December): 165–76. <https://doi.org/10.1016/j.rser.2018.08.041>.
- Kiernicki, Chloe, Sakshi Kakkad, Mehmet Bermek, Russell Gentry. 2021. "A Digital Process for Reconstructing Wind Turbine Blade Geometry from Point Cloud Data." In *Proceedings of International Conference on Structures & Architecture*. Aalborg, Denmark.
- Liu, Pu, and Claire Y. Barlow. 2017. "Wind Turbine Blade Waste in 2050." *Waste Management* 62 (April): 229–40. <https://doi.org/10.1016/j.wasman.2017.02.007>.
- Midcontinent Independent System Operator (2019). *Transmission Cost Estimation Guide*
- Polymeneas, Evan, Adam Rubin, and Humayun Tai. (October 2020) *Modernizing the Investment Approach for Electric Grids*. McKinsey and Company. <https://www.mckinsey.com/industries/electric-power-and-natural-gas/our-insights/modernizing-the-investment-approach-for-electric-grids>
- Tasistro-Hart, Benjamin, Tristan Al-Haddad, Lawrence C. Bank, and Russell Gentry. 2019. "Reconstruction of Wind Turbine Blade Geometry and Internal Structure from Point Cloud Data." In *Computing in Civil Engineering 2019*, 130–37. Atlanta, Georgia: American Society of Civil Engineers. <https://doi.org/10.1061/9780784482438.017>.
- WindEurope. 2020. "Accelerating Wind Turbine Blade Circularity." May 2020. <https://windeurope.org/data-and-analysis/product/accelerating-wind-turbine-blade-circularity>.

The Public and the Technocratic Smart City

Taraneh Meshkani¹

¹Kent State University, Kent, OH

ABSTRACT: Smart cities are becoming the new paradigm for urban governance and development. Local governments worldwide are increasingly incorporating smart technologies into the urban infrastructure in competition with other cities. One approach commonly applied in smart city initiatives is through public-private partnerships with technology and development companies, which raises the questions of ownership of public data and the governance of a centralized planning apparatus. By analyzing two smart city projects of Songdo City in Incheon, the Republic of Korea, and Sidewalk Labs in Toronto, Canada, this paper investigates the urban challenges of privatization, the city as a digital platform, technologically led planning processes, and privacy in technocratic smart cities in order to inform the development of future smart city projects.

KEYWORDS: Smart Cities, Songdo City, Sidewalk Labs, Private-Public Partnership, City Planning, Data Governance

INTRODUCTION

With the rise of information and communication technologies (ICTs) comes a new spatial condition that is geographically unlimited and resides in both physical and virtual spheres. Because of the nature of ICTs and their reliance on hardware and software, they possess physical and virtual bearings that concern a myriad of spatial issues of materiality, scale, territory, and spatial politics.

One manifestation of such hybrid spaces is the notion of smart cities. With the integration of data analytics and smart technologies, these innovations address urban challenges in relation to transit, housing, energy, sustainability, waste management, and gather significant real-time data from all forms of interactions, including private data that tracks the movement of citizens. The centralized data is used to analyze people's behaviors and things that allow governments to manage the operations of the city. More advanced forms of smart cities can inspire technocratic urban governance that can even influence human behavior, shifting people from undesirable acts to socially accepted behavior. However, this form of government has a concealed neoliberal characteristic that tends to lead to market-driven decision-making. The strongest supporters of this smart city framework are technology companies such as Google, Amazon, and Microsoft. These companies benefit from a vast collection of data, disseminating new technologies, and open economic policies. Governments also benefit from smart cities by being able to offer sustainable, healthy, safe, and productive spaces for work and living. As cities become smarter, establishing a governing framework for the management of data and technocratic decision-making becomes paramount, especially as more cities seek private-public partnerships (PPPs).

By analyzing smart city projects such as Sidewalk Labs in Toronto, Canada, and Songdo City in Incheon, the Republic of Korea, this paper makes inquiries into the relationship between citizens, governments, and multinational technology companies.

1. METHODOLOGY

The paper studies two smart cities in a comparative approach through methods of qualitative analysis of publicly available proposals and documents submitted by the two leading corporations. The key documents reviewed for this study include the Master Innovation and Development Plan (MIDP) submitted by the Sidewalk Toronto and the Development Plan of the Incheon Free Economic Zone (IFEZ) for Songdo City. In addition to key documents, extensive research was conducted on third-party studies of the two cities, along with the literature review of scholarship on smart cities. The paper investigates four areas of urban challenges of technocratic smart cities in relation to the cases namely, privatization, the city as a digital platform, technologically led planning processes, and privacy.

1.1. Case Study: Songdo City

Songdo is built within the premises of Incheon Metropolitan and is one of the earliest models of the smart cities of the future [Figure 1]. The city is a utopian vision that tries to solve Seoul's problems, such as overcrowded space and pollution, and promises a high-tech, sustainable city. It is built on 1,500 acres of a landfill site, with an investment of

US\$35 billion; its goal was to provide housing for 250,000 inhabitants by 2020. As a suburban extension of Incheon, some compare Songdo to Ebenezer Howard's Garden City idea. Songdo is one example of U-City initiatives that were proposed in the Republic of Korea in the 1990s.



Figure 1: City of Songdo Buildings. (Max Pixel)

In the competition among global cities, the U-City policies and plans tried to attract capital to make cities in the Republic of Korea major economic hubs. Songdo as an urban development project is an example of cities where over-accumulation of capital manifests in development projects and represents what David Harvey calls “spatial fix” (Harvey 2001).

Even though it is clearer now that Songdo has mostly used a smart city brand, the project stakeholders, Incheon City Government and New Songdo International City Development (NSICD), raised property values by rezoning and increasing development. The housing prices in Songdo are significantly higher than in other areas in Incheon (Kim 2011). The inequality in housing has resulted in other disparities. Since 2012, four branch campuses of foreign universities along with two foreign schools have been founded (Yoo 2017). The uneven development and regional inequalities that take place in Songdo are against the promises of inclusivity and integration by smart city policies.

1.2. Case Study: Sidewalk Labs

Another example of smart city initiatives is the Sidewalk Labs Quayside Neighborhood Project, which was a smart mixed-use development proposal for a new planned harbourfront neighborhood close to the downtown of Toronto. The Toronto Waterfront Revitalization Corporation put out an RFP in March 2017 for the Quayside development opportunity. Alphabet's Sidewalk Labs won the bid to develop the master plan of the 12-acre parcel [Figure 2]. The project aimed to adopt technological innovations and new construction methods such as multi-level timber buildings. In addition, the project aimed to tackle urban challenges such as mobility, the public realm, and housing, among others. The initiatives included the development of a transportation system to reduce reliance on automobiles and allocate 40 percent of residential units below-market to create affordable housing.

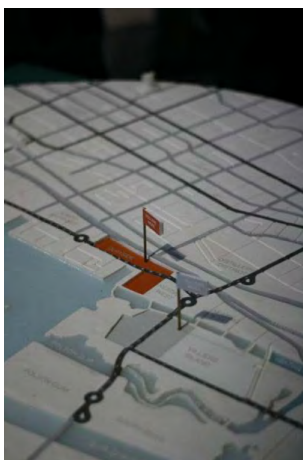

Figure 2: Sidewalk Urban Model of Harbourfront Toronto. (Author, 2020)

Sidewalk Labs also took the initiative to develop a “Responsible Data Use” report and a proposal for a data trust to manage public data collected through the physical infrastructure [Figure 3]. However, the project faced significant criticism for its intention and how it would monetize public data considering its close relations with Alphabet, Google's sister company. The lack of transparency and the surprise release of its first proposal after a year and a half also

raised criticism against the project (Austen 2021). The pressure continued to mount, and on May 7, 2020, Sidewalk Labs CEO, Daniel Doctoroff, announced that they would no longer pursue the Quayside project (Doctoroff 2021).



Figure 3: Sidewalk Labs Model of Mixed-Use Development. (Author, 2020)

2. DISCUSSION

2.1. Smart City Movement and its Origins

“Smart city” both as a concept and in practice has a multitude of definitions. For example, in the past two decades, there has been a myriad of interpretations of computationally network urbanism such as “wired cities” (Dutton 1987), “informational cities” (Castells 1989), “cyber cities” (Graham 1999), “digital cities” (Aurigi 2005), “intelligent cities” (Kominos 2013), “ubiquitous cities” (Shin 2009), and “sentient cities” (Shepard 2011).

But the new term suggests the use of ubiquitous smart technologies that sense, process, and utilize data to monitor individuals, crowds, and environments to allow the city administrators to become more responsive to the changes in the city to enhance the lives of their citizens. While the definition of “smart city” may vary from time to time, public-private partnerships (PPPs) are often present in implementing these projects. The value of smart technologies for the city is to improve its overall operations and help it to become more efficient. On the other hand, for technology companies, a smart city provides access to vast amounts of user data, which they can learn from to improve and monetize their services. PPPs have played a central role from the beginning in the creation of smart cities. In fact, the term “smarter cities” was first coined by IBM framed under a vision that described how “cities can lead the way into a prosperous and sustainable future” (IBM 2009). The IBM campaign was launched during the 2008 financial crisis when austerity measures were in effect worldwide, and cities were strapped for cash. At the same time, the world was undergoing urbanization and becoming interconnected with the convergence of digital and physical infrastructures. Thus, the combination of the recession and increased urbanization became the catalyst to build smarter cities. As a result of the campaign, IBM alone saw an increase in revenue from 2008 to 2012 following the financial crisis (Paroutis 2014). Soon, other technology heavyweights launched their own campaigns, which included Cisco’s “Internet of Everything,” Siemens’ “City Intelligence Platform,” Huawei’s “Smart City Solution,” among others. The idea of smart cities was also in line with the strategies of city administrators that sought private investment. Similarly, the Public-Private Partnership initiatives were also launched following the 1992 financial crisis. Hence, one of the most important urban challenges of smart city projects is the issue of privatization which will be further examined in the findings section of the paper.

3. FINDINGS

Based on the analysis of two projects of Songdo and Sidewalk Labs, the findings of this paper are categorized into four key areas of urban challenges that technocratic smart cities encounter. The four categories of privatization, the city as a digital platform, technologically led planning processes, and privacy are analyzed through a comparative approach using the two case studies.

3.1. Privatization

The concept of a smart city is intertwined with PPPs, which helped the local governments with the transition from the economic recession and become competitive in relation to other global cities. The privatization of public spaces was intensified with the rise of neoliberalism in the late 1970s and its height in the 1990s. Globalization accelerated the flow of capital and cities became magnets for foreign investments. The smart city movement embodied a new vision for creating sustainable, socially balanced, and economically feasible cities without much government burden (Rossi

2016). “It served as a ‘low-cost, enabling strategy’ where public investments would fund ‘opportunities’ instead of planned-out, large-scale solutions” (Voorwinden 2021). Some scholars highlight the smart city movement as an expression of restructuring of urban space by market-led initiatives (Brenner; Theodore 2002) and thus naming these projects as “private city” (Adams 2010), or “entrepreneurial city” (Harvey 1989). The most important aspect of the privatization and marketization of smart cities is the question of governance. In most smart city projects, governments are no longer needed to govern but to advise. This new way of managing cities minimizes the processes of democratization and accountability.

The smart city movement promotes an apolitical approach to urban management (Swyngedouw 2018). It seems that in the existing smart city initiatives, the interest of citizens will not be represented by private entities and could, in fact, be in conflict with market interests. As an example, in the Songdo City project, the city of Incheon holds 28.6% of the shares while the rest is divided among private entities such as Gale International, and Cisco among others (Lee 2016). Similarly, in the case of Sidewalk Toronto, the project was seen as an attempt to privatize government, by giving Alphabet the ability to monitor citizen activities and manage a portion of the public lands. In addition, Alphabet partnered with one of the world’s largest institutional investors, the Ontario Teachers’ Pension Plan, to lead a private firm that aims to modernize infrastructure.

3.2. Planning

One of the areas in which private-public partnerships aim to align the city’s interests with corporations is within the initial planning processes. The planning phase is when the large-scale projects become a reality or are discontinued. The consultations stage incorporates feedback from key stakeholders such as local governments, citizens, private sectors, and other investors. The more controversial the project, the more significant the consultation process becomes. According to Alphabet’s Sidewalk Toronto, the company organized 18 months of town halls and roundtables to gather public input for the project. However, people had criticized the project because of a lack of transparency around data ownership and usage. In Toronto, a group of 30 residents organized behind the campaign #Blocksidewalk to take on big tech and voice their objection against the controversial project. Campaign organizers demanded that “important decisions on the city’s future be made through fair, democratic, inclusive, transparent and accountable processes led by Torontonians,” rather than by technology giants behind closed doors (Vincent 2019).

One of the promises of smart cities is to shift the preliminary discovery process of any given project and make it continuous. The idea is to allow city planners to explore the data on an ongoing basis and create models that are “more accurate, current, and representative” of what is happening in their city (Bowden 2018). Sidewalk Labs started Replica in 2018, an urban planning tool that would utilize a small user data sample to create a “virtual population that is statistically representative of the real population” (Replica 2019). By creating a synthetic population, planners will have the ability to analyze the city’s processes and how their decision could impact the movement of their population. Smart city planning tools such as a virtual population have the potential to transform the idea of consultation, creating greater equality than the existing process currently offers. As a result, smart cities are typically promoted as the future of city planning. The new technology allows planners to access real-time and accurate data about how the population uses the city, and they are commonly compared with existing processes that could become lengthy and expensive.

The smart city of Songdo has a control center located at the IFEZ G-Tower. All the data collected using CCTV cameras, smart meters, and sensors are used to analyze the city’s activities, allowing planners and administrators to respond using the most accurate information about the city.

On the other hand, private companies adopt universal technological solutions unrelated to the notion of placemaking as urban designers and planners know it. Moreover, a lack of familiarity with smart systems and technologies may hinder design professionals and planners from intervening and proposing solutions for urban problems. Currently, social, and cultural issues are not easily measured quantitatively, and the same technological solutions do not regard cities as unique contexts with their political, cultural, and social processes. There are limits to the approach of smart cities, which for the most part, is data-driven and considers the city as a digital platform.

3.3. The City as a Platform

One key notion in relation to smart city discourse is the “platform concept.” The city as a platform highlights the existence of a digital layer over the physical, which is mainly composed of data and its technologies and services. For example, Sidewalk Project analogizes “the city as a network stack of a computer operating system,” which functions similarly to the internet as a platform.

Data is the key component of smart city strategies and becomes the most important capital. In order to collect data, “citizenship transforms into citizen sensing” (Gabrys 2014) through interaction with sensing and mobile technologies. This raises the question of how the conceptions of subjectivity and citizenship change in smart cities and how these changes can transform the governmentality and politics of the built environment along with the design and use of urban spaces?

In many smart city projects, it is not clear who collects and has access to the data. So, the question of how public data is governed becomes critical. Creating a data management framework is essential for the development of a smart city, providing clear guidelines for all stakeholders on how the city's data is managed. One of the initial actions Sidewalk Labs took was to issue a Responsible Data Use Policy Framework, which laid out its approach to “data privacy, stewardship, access, and security.” The company also proposed a “data trust to ensure transparent governance over data issues” (Sidewalk Labs LLC 2019). Sidewalk Labs offered to use sensors in physical locations to collect “non-personal data” such as weather conditions, temperature, and other de-identified data. However, Ontario’s information and privacy commissioner expressed concerns that the data trust lacks “legislative framework to protect privacy and access rights” and is without an independent oversight. The commissioner also raised concerns about the city having access to the data trust, stating that the local government and the city of Toronto would have to apply in order to gain access to their own data (Vincent 2019).

Control of data in smart cities equates the control over the built environment. The private companies that govern smart cities can influence planning policies, shape civic participation channels, monitor energy and transportation infrastructures, and reshape public spaces. The control over the digital platform directly impacts different processes that shape and reshape the built environment. Such examples include the transformation of curbs, sidewalks, roads, the configuration of parks, and the reach to the private domain when it comes to housing and health issues.

On the other hand, when the city is considered as a digital platform, the platform becomes the foremost important aspect of the city rather than the built environment. Moreover, this digital layer itself is not neutral. The online platform connects to the logic of the market and its value system. In many smart city projects, it becomes a tool to increase property values rather than designing cities to improve citizens' lives. In addition, it may seem that smart technologies and the digital platform are non-ideological; however, they “are inherently politically and ideologically loaded in vision and application, reshaping in particular ways how cities are managed and regulated” (Kitchin 2015).

The smart city of Songdo in the Republic of Korea and the initial policies adopted for U-City developments is a great example [Figure 4]. Urban data in Songdo is collected by the Urban Integrated Information Centre of Incheon Free Economic Zone (IFEZ), which is a center managed by Cisco. Even though there have been applications by IFEZ for citizens, there is not much transparency of data and no process to involve inhabitants in the city's decision-making processes. The smart systems deployed in Songdo do not match the efficiency and promises of smart city projects, therefore not enhancing the lives of its inhabitants as it was advertised.



Figure 4: The City of Songdo Under Construction, Incheon, South Korea. (Mirashin1)

The city as a digital platform is reliant on tech giants such as Alphabet for Sidewalk Labs Toronto and Cisco for Songdo, which by design, ends up having technologies top of mind rather than the built environment and needs of the population. When technology companies lead the creation of smart cities, their focus becomes collecting data first and foremost, regardless of whether the information collected will enhance city life since part of their business model is the monetization of data. This leaves us wondering whether all the data that these smart cities aim to collect directly seek to create a better living environment?

3.4. Privacy

One of the key challenges of the city as a platform and PPPs is the issue of privacy. Today, as users browse the internet, their activities are tracked by technology companies. Clario, a cyber security and online privacy company, studied how major technology companies are tracking digital data for marketing and analytics. Companies are tracking basic information such as name, date of birth, and email, but they can also follow more specific data such as financial and personal information. Not surprisingly, Facebook ranked top of the list with almost 80% of their user's data collected. Facebook can collect various personal information, including sexual orientation, religious beliefs, employment information, and more (Slynchuk 2021). The personal data that websites track are primarily used for advertising. For example, Facebook made almost their entire 2020 revenue from advertising worth \$96 billion (Facebook Inc 2021). Tracking user data is at the core of the business model for technology companies since their revenue relies primarily on how well they can track and advertise to their users. The next frontier for data-hungry companies is going beyond digital and into the physical world. Jim Balsillie, the former CEO of BlackBerry, questions the validity of the technology company's push into smart city and urban development space. Balsillie states that "Your offline data is way more

valuable than your online data — and your online data is really valuable"(Austen 2020). One example is the use of CCTV cameras in Songdo City to help detect crime and other suspicious activities, which also means that citizens are surveilled all across the city at all times. In Toronto, an expert panel on Sidewalk Labs' proposal raised the question of "whether sufficient benefits had been identified to justify the proposed collection or use of data." The expert panel report also mentioned the business nature of technology companies and the need to explicitly clarify that "no Alphabet enterprise will monetize personal information and its derivatives, nor share these with third parties, without appropriate authorization" (Waterfront Toronto 2020). While private companies also lead the development of Songdo smart city, the project has decided not to monetize the data it collects. The business model of technology companies will inevitably lead their decision-making concerning data collection and usage regardless of whether it is in the digital or physical space.

As a result, cities need to establish their own governance for collecting, analyzing, and maintaining citizens' data rather than outsourcing it to private companies with profit as their primary motive.

CONCLUSION

The 2008 financial crisis forced austerity measures on many cities worldwide, which led to local governments seeking private investment to meet their development needs. Smart city projects were one of the ways that cities sought private investment from technology and development companies. These smart initiatives became the next wave of PPPs, with technology companies leading the way. As a result, a surge of technocratic smart cities paved the way for new governance and planning, driven primarily by the collection of data. By analyzing the two smart city projects of Songdo City in Incheon, the Republic of Korea, and Sidewalk Labs in Toronto, Canada, this paper examines the urban challenges of privatization, the city as a digital platform, technologically led planning processes, and privacy in technocratic smart cities. The outcome suggests that smart city initiatives need to be led by the city and its citizens rather than outside private interests. The city can ensure that the values of its citizens are incorporated into the new infrastructure shaping its future development. In contrast, a private corporation is driven by profit motives and will always pursue the best interest of its shareholders. While smart cities will provide new and advanced tools for planners, the role of design professionals and planners will be pivotal to the success of these initiatives since cities have complex social, cultural, and political dynamics that technology alone cannot sufficiently address. In addition, the aesthetic choices of how the built environment is developed play a significant role in the characteristics of the city. Issues of inclusivity and equality also need to be top of mind to prevent the creation of gentrification and disparities among communities. Lastly, the new digital infrastructure will play a central role in the development of smart cities. Similar to how the city owns and manages its physical infrastructure, it also needs to maintain control over its digital infrastructure and footprint. This will ensure that any data collected will have direct value for citizens and city planning, and third-party entities will not monetize the interaction of their population in the physical space.

REFERENCES

- "A Vision of Smarter Cities: How Cities Can Lead the Way into a Prosperous and Sustainable Future". 2009. *IBM Global Business Services*, (December). <https://www.ibm.com/downloads/cas/2JYLM4ZA>.
- Adams, Ross. 2010. "COMMENTARY Longing for a Greener Present: Neoliberalism and the Eco-city." *Radical Philosophy* 163.
- Aurigi, Alessandro. 2005. "Competing urban visions and the shaping of the digital city." *Knowledge, Technology & Policy* 18, no. 1: 12-26.
- Austen, Ian. 2019. "Trash-Picking Robots? Park Bench Monitors? Toronto Debates Tech Giant's Waterfront Plans." *The New York Times* (June 24). Accessed October 5, 2021. <https://www.nytimes.com/2019/06/24/world/canada/toronto-google-sidewalk-labs.html>.
- Austen, Ian. 2020. "You Can't Fight City Hall. But Maybe You Can Fight Google" *The New York Times*, (March, 10). Accessed October 7, 2021. <https://www.nytimes.com/2020/03/10/world/canada/toronto-sidewalk-labs-google.html>.
- Bowden, Nick. 2018. "Introducing Replica, a Next-Generation Urban Planning Tool." Sidewalk Labs, (April 6). Accessed October 7, 2021. <https://www.sidewalklabs.com/insights/introducing-replica-a-next-generation-urban-planning-tool>.
- Brenner, Neil, and Nik Theodore. 2002. "Cities and the geographies of "actually existing neoliberalism"." *Antipode* 34, no. 3: 349-379.
- Castells, Manuel. 1989. *The Informational City: Information Technology, Economic Restructuring and the Urban-Regional Process*. Oxford: Blackwell.
- Doctroff, Daniel L. 2020. "Why We're No Longer Pursuing the Quayside Project — and What's next for Sidewalk Labs." Medium, (May 7). Accessed October 5, 2021. <https://medium.com/sidewalk-talk/why-were-no-longer-pursuing-the-quayside-project-and-what-s-next-for-sidewalk-labs-9a61de3fee3a>.
- Dutton, William H. 1987. *Wired cities: Shaping the future of communications*. Macmillan Publishing Co., Inc.

- "Facebook Inc. January 28, 2021 - 10-K: Annual report for year ending December 31, 2020", 2021. *United States Securities and Exchange Commission*, Washington D.C. 20549.
<https://www.sec.gov/ix?doc=/Archives/edgar/data/1326801/000132680121000014/fb-20201231.htm>.
- Gabrys, Jennifer. 2014. "Programming environments: Environmentality and citizen sensing in the smart city." *Environment and planning D: Society and space* 32, no. 1: 30-48.
- Graham, Stephen, and Simon Marvin. 1999. "Planning cybercities? Integrating telecommunications into urban planning." *The Town Planning Review*: 89-114.
- Graham, Stephen, and Simon Marvin. 2001. *Splintering Urbanism: Networked Infrastructures, Technological Mobilities and the Urban Condition*. London: Routledge & Kegan Paul.
- Greenfield, Adam. 2013. *Against the Smart City*. New York: Do projects.
- Harvey, David. 1989. "From managerialism to entrepreneurialism: the transformation in urban governance in late capitalism." *Geografiska Annaler: Series B, Human Geography* 71, no. 1: 3-17.
- Harvey, David. 2001. "Globalization and the "spatial fix"." *geographische revue: Zeitschrift für Literatur und Diskussion* 3, no. 2: 23-30.
- Hollands, Robert G. 2008. "Will the real smart city please stand up? Intelligent, progressive or entrepreneurial?." *City* 12, no. 3: 303-320.
- Hollands, Robert G. 2015. "Critical interventions into the corporate smart city." *Cambridge journal of regions, economy and society* 8, no. 1: 61-77.
- Incheon Free Economic Zone official website: <https://www.ifez.go.kr/ivt075>, accessed October 5, 2021.
- Ishida, Toru. 2002. "Digital city kyoto." *Communications of the ACM* 45, no. 7: 76-81.
- Kim, C., and T. Park. 2011. "A study for the comovement of apartment prices between Songdo FEZ and Yeonsoo-Gu, Incheon." *Korea Real Estate Academy* 44: 314-329.
- Kitchin, Rob. 2013. "The Real-Time City? Big Data and Smart Urbanism." *GeoJournal* 79, no. 1: 1-14.
- Kitchin, Rob, Tracey P. Lauriault, and Gavin McArdle. 2015. "Smart cities and the politics of urban data." In *Smart urbanism*, pp. 16-33. Routledge.
- Kitchin, Rob. 2016. "The ethics of smart cities and urban science." *Philosophical transactions of the royal society A: Mathematical, physical and engineering sciences* 374, no. 2083: 20160115.
- Komninos, Nicos. 2013. *Intelligent cities: innovation, knowledge systems and digital spaces*. Routledge.
- Lee, Sang Keon, Heeseo Rain Kwon, HeeAh Cho, Jongbok Kim, Donju Lee, Sang Keon Lee, Heeseo Rain Kwon et al. 2016. "International case studies of smart cities: Songdo, Republic of Korea." <https://publications.iadb.org/publications/english/document/International-Case-Studies-of-Smart-Cities-Songdo-Republic-of-Korea.pdf>.
- Martin, Reinhold. 2003. *The Organizational Complex: Architecture, Media, and Corporate Space*. Cambridge, MA: MIT Press.
- "Master Innovation and Development Plan (MIDP)." Sidewalk Labs LLC, 2019. Accessed October 7, 2021.
https://storage.googleapis.com/sidewalk-labs-com-assets/MIDP_Volume0_1fa269dff/MIDP_Volume0_1fa269dff.pdf
- Mitchell, William J. 1995. *City of Bits: Space, Place, and the Infobahn*. Cambridge MA: MIT Press.
- Paroutis, Sotirios, Mark Bennett, and Loizos Heracleous. 2014. "A strategic view on smart city technology: The case of IBM Smarter Cities during a recession." *Technological Forecasting and Social Change* 89: 262-272.
- Picon, Antoine. 2015. *Smart cities: a spatialised intelligence*. John Wiley & Sons.
- "QUAYSIDE Request for Proposals Innovation and Funding Partner for the Quayside Development Opportunity.", *Waterfront Toronto*, April 27, 2017. <https://quaysideto.ca/wp-content/uploads/2019/04/Waterfront-Toronto-Request-for-Proposals-March-17-2017.pdf>.
- Replica. "Introducing Replica." YouTube Video, Jul 19, 2019.
<https://www.youtube.com/watch?v=HbH6vuT8JKw&t=133s>.
- Rossi, Ugo. 2016. "The variegated economics and the potential politics of the smart city." *Territory, Politics, Governance* 4, no. 3: 337-353.
- Sassen, Saskia. 1991. *The Global City*. Princeton, NJ: Princeton University Press.
- Sennett, Richard. 2012. "No One Likes a City That's Too Smart." *Guardian*.
- Shepard, Mark. 2011. *Sentient city: Ubiquitous computing, architecture, and the future of urban space*. The MIT press.
- Shin, Dong-Hee. 2009. "Ubiquitous city: Urban technologies, urban infrastructure and urban informatics." *Journal of Information Science* 35, no. 5: 515-526.
- Sidewalk Infrastructure Partners (SIP), "Infrastructure must evolve to leverage technology," About SIP, June, 2020, <https://sidewalkinfra.com/about/index>.
- Slynychuk, Andriy. 2021. "Big Brother Brands Report: Which Companies Might Access Our Personal Data the Most?" Clario, (July 22). Accessed October 7, 2021. <https://clario.co/blog/which-company-uses-most-data/>.
- "Songdo: The World's Smartest City?" UNC Institute for the Environment. June 14, 2019. Accessed October 7, 2021. <https://ie.unc.edu/clean-tech-post/songdo-the-worlds-smartest-city/>.
- Swyngedouw, Erik. 2018. *Promises of the political: Insurgent cities in a post-political environment*. MIT Press.

- Townsend, Anthony M. 2013. *Smart cities: Big data, civic hackers, and the quest for a new utopia*. WW Norton & Company.
- Vanolo, Alberto. 2014. "Smartmentality: The smart city as disciplinary strategy." *Urban studies* 51, no. 5: 883-898.
- Vincent, Donovan. 2019. "Newly Formed Citizens Group Aims to Block Sidewalk Labs Project." *Toronto Star*, (February 25). Accessed October 6, 2021. <https://www.thestar.com/news/gta/2019/02/25/newly-formed-citizens-group-aims-to-block-sidewalk-labs-project.html>.
- Vincent, Donovan. 2019. "Sidewalk Labs' Urban Data Trust Is 'Problematic,' Says Ontario Privacy Commissioner." *Toronto Star*, (September 26). Accessed October 7, 2021. <https://www.thestar.com/news/gta/2019/09/26/sidewalk-labs-urban-data-trust-is-problematic-says-ontario-privacy-commissioner.html>.
- Voorwinden, Astrid. 2021. "The privatised city: technology and public-private partnerships in the smart city." *Law, Innovation and Technology*: 1-25.
- "Waterfront Toronto's Digital Strategy Advisory Panel DSAP Supplemental Report on the Sidewalk Labs Digital Innovation Appendix (DIA)." *Waterfront Toronto*, February 26, 2020. <https://quaysideto.ca/wp-content/uploads/2020/02/DSAP-Supplemental-Report-on-Sidewalk-Labs-Digital-Innovation-Appendix-DIA-Appendices-FINAL.pdf>.
- Yoo, Seungdo. 2017. "Songdo: The hype and decline of world's first smart city." In *Sustainable Cities in Asia*, pp. 146-160. Routledge.

Precedent and Influence: An Urban Design Studio Project

Dwaine Carver¹

¹University of Idaho, Boise, ID

ABSTRACT: An 8-week vertical studio project investigates the uses and limits of precedent in architectural and urban design. Setting aside issues of originality, historical and contemporary precedents were utilized as direct source material for student works. Combining overtly appropriated precedents with collage techniques such as cut-up, sampling, and remix, students explored alternative design methods toward the development of a heterogeneous and inclusive urbanism. Design prompts required short iterations developing high-density housing, articulated municipal networks, ecological systems, and cultural spaces. Prompts and readings indicated the historical breadth and relevance of appropriative and collagist techniques and methods. Students given license to become 'active readers' of history, to work transparently and forcefully with precedent, encountering the history of the discipline as a cultural commons of knowledge, revealed that appropriation enriched the range of their methods, resulting in transformed, engaged, and paradoxically, original works.

KEYWORDS: Pedagogy, Inclusive, Urbanism, Collage, Precedent

1.0 INTRODUCTION

"By necessity, by proclivity, and by delight, we all quote." (Lethem, 2007, p 68)

In the *Journal of Architectural Education* issue, "Beyond Precedent," editor George Dodds notes that within architectural education, "the use of precedent has become pro forma—as ubiquitous as it is often perfunctory" (JAE 2011, p 5). The *JAE* issue is a response to and meditation upon the *Harvard Architectural Review* issue, "Precedent and Invention," published 25 years previously (Harvard Architectural Review 1986). Dodds is especially interested in the discursive and pedagogical engagements of the precedent/invention binary; paraphrasing Colin Rowe, he writes, "precedent is little more, and nothing less, than the verso to the recto of invention." (JAE 2011, p 5).

This paper, an overview and assessment of an 8-week vertical urban design studio project, continues that exploration. Using collage and appropriation to press the limits of authorship and originality, the studio investigated forceful uses of precedent toward alternative design methods and the development of an expanded engagement with history, ecology, and the city.

2.0 OBJECTIVES

An excerpt from the studio project brief reads as follows:

Investigating the historical role and limits of 'influence' in art and design processes, students will further their abilities in architectural design as cultural critique and projective practice. Techniques such as collage, cut-up, copy/paste, and appropriation will be used to generate alternative methods of architectural design. Architectural precedents, historical and contemporary, will be utilized as raw material for the design work.

In addition to developing experimental housing as strategic interventions, students will identify supporting programming toward the development of a district, designing for multiple networks: transportation, culture, ecology, recreation, and production at multiple scales.

The project site is a typical U.S. suburban district. The 170-acre area includes 4-lane arterials with traffic counts of 50,000, strip retail and big box stores totaling 220,000 square feet, 1,400 surface parking spaces, and, aside from roadway attached sidewalks, zero square feet of public space. Adjacent but disconnected are single-family neighborhoods: 3-bedroom dwellings on 0.16-acre lots. The program brief required 75 acres of new open public space, 15,000 housing units, and 300,000 square feet of retail, business, and cultural space. (Figure 1)

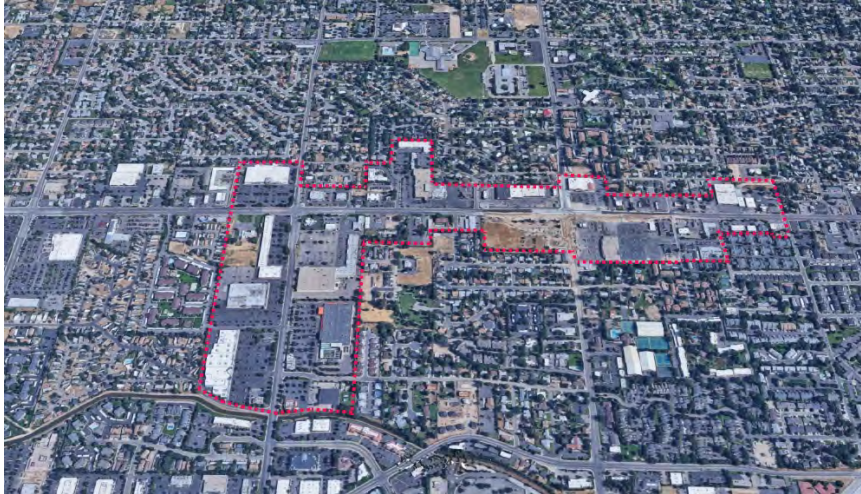

Figure 1: Aerial view of district with 170-acre project area marked. Source: (Google Maps)

The objectives of the project were:

- To understand precedent as a cultural commons of architectural knowledge
- To utilize appropriation as a strategic engagement of heterogeneity and inclusivity
- To deploy collage in explorations of resilient, ecological, social and cultural networks
- To use collage techniques to facilitate experimental design at multiple scales

3.0 METHODS

3.1. Precedent and Authorship

Studio readings initiated a discussion regarding authorship and originality by opening up the tensional field of 'precedent and invention' with a straightforward proposition: appropriation. Students were encouraged to experiment with precedent without fear of charges of plagiarism. As Winy Maas states, "In contemporary Western culture, the act of copying is seen as dishonest, immoral and even illegal." (Maas 2018, p 98). Proffering a corrective to this ideology, Jonathan Lethem writes, "Finding one's voice isn't just an emptying and purifying of oneself [...] but an adopting and embracing of filiations, communities, and discourses" (Lethem 2007, p 61). (Lethem will reveal to readers at the end of his essay he 'plagiarized' this particular quote from George L. Dillon and furthermore, the essay is entirely composed of 'plagiarized' quotes from beginning to end.) As both Lethem and Maas point out, our collective obsession with originality is a recent development, a rejection of traditional understandings of the continuum of knowledge in favor of its privatization and commodification.

In response to these critiques of originality, students embraced their 'creative filiations' with the understanding their precedent selections should be born of deliberative research, that the particularities of selection require analysis, and knowledge of the community and its discourses. (Figure 2)



Figure 2: Student Work, Site Analysis. Source: (Kelsey Ramsey, University of Idaho)

3.2. Collage

Collage, as a generalized method, emphasizes process over product, the contingent over the systematic, the fragmentary over the synthesized, the inclusive over the exclusive, the simultaneous over the sequential. In her book *Collage and Architecture*, Jennifer A. E. Shields identifies broad categories of collage techniques: 'Papier collé and found materials, collage-drawing, photomontage, and digital methods' (Shields, 2014). Mies van der Rohe's body of work alone provides a span of examples. His affiliations with Dada artists Kurt Schwitters, Raoul Hausmann and others utilizing collage and photomontage techniques in the 1920s are well known (Shields, p 72). But as Martino Stierli points out, Mies's 1910 photomontage for a Bismarck national monument competition predates his encounters with the Dadaists (Stierli, 2010 p 65). For Stierli, the technique is crucially ideological: "photomontage was a response, not to romantic concepts of artistic invention, but to the new possibilities of mechanical reproduction" (Stierli, 2010 p 64). Neil Levine also explores how Mies's collage works include political content and later, facilitate a shift toward "readymades" and monumentalizing technique (Levine, 1998, pp 92 - 94). Both authors argue that Mies's collages are inextricably inclusive of social and political content.

In *Collage City*, Colin Rowe and Fred Koetter propose collage as a method of historical inclusion. The model for the architect-collagist is a *bricoleur*, an assembler of heterogenous elements of the city. Their discussion of *bricolage*, borrowing dialectical pairs from both Claude Levi-Strauss and Isaiah Berlin, argues for the necessity of the inclusive and empirical *bricoleur* as a remedy to modern architecture's privileging of the exclusive and rational engineer, a pluralistic 'fox' as the necessary counterpart and remedy to the monistic 'hedgehog' (Rowe and Koetter, 1978, pp 86 – 117).

The studio poses the following: If inclusivity is fundamentally plural, then must a city attempt to account for all its inhabitants, all of its histories, even if such a task is impossible? Might an inclusive city necessarily be agonistic, fragmentary, and contingent? Collaged iterations of appropriated district plans, cut, sampled and remixed, provide the initial visualizations for design at the district scale in response. (Figure 3)

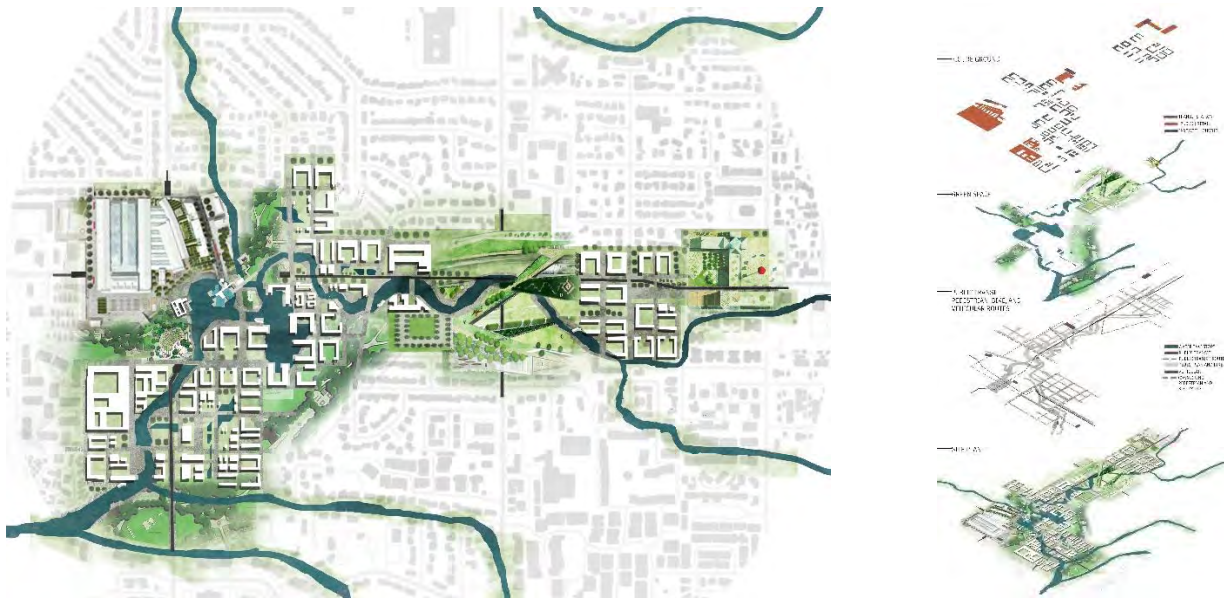

Figure 3: Student Work, District Site Plan and Exploded Axonometric. Source: (Samantha Jesser, University of Idaho)

3.3. Scaling Appropriations

In addition to collaging precedents at city and district-scales, the studio explored techniques able to more finely transform quoted materials. The literary technique of 'cut-up' as well as the musical analogs of 'sample and remix' were applied by students to building-scale works. These concepts allow for a finer grain of appropriation, cutting selected precedents into smaller portions, quoting elements at the scale of buildings or their elements: room, stair or wall.

Two exemplars of this practice are Daniel Libeskind's thesis work at the Cooper Union and James Stirling's "Red Buildings" and later works. In the case of Libeskind, collage is the vehicle for both the dissection of precedent and its transformation via reassembly. Jennifer Shields points out the procedure is reminiscent of Bernhard Hoesli at the University of Texas Austin where he would "cut apart and reconfigure the drawings of his students" (Shields, p 78). In "Architecture as a Continuous Text," Alan Colquhoun states that Stirling's use of "historical fragments" are an acknowledgement of the loss of a singular *zeitgeist*, typological elements are used as "readymades," and "figural

fragments make no pretense at reconstructing the organic conditions of their original appearance” (Colquhoun, 1993, p 19). The two bodies of work demonstrated to students several building-scales of thinking through historical precedent. (Figure 4)



Figure 4: Student Work: Building Section, housing; Public Building Plan, 'cut-up' study; Source: (Kayla Duclos, left; Samantha Jesser, right, University of Idaho)

3.4. Thinking through History

Placing the remote in proximity, collage insists upon a nonlinear understanding of historical time. It is a method for visualizing the event of simultaneity. Randall Teal explains Martin Heidegger’s concept of *geschichte* in his essay, “Foundational History;” he writes, “*Geschichte* [...] presents a view of history that is distinguished by the suddenness and coming to presence of a past that has not really passed away” (Teal, 2011). Such a view of history does not support nostalgia nor mere recapitulations of static, historical form.

Students investigated the cultural/social and physical histories of the site and then proposed the projection of those attributes ‘that had not really passed’ onto its future. Agriculture and irrigation works from the late 19th and early 20th century are reimagined as 21st century performance landscapes, or more distantly, geological formations and imagined rituals are proposed as new programs for public space. (Figure 5)

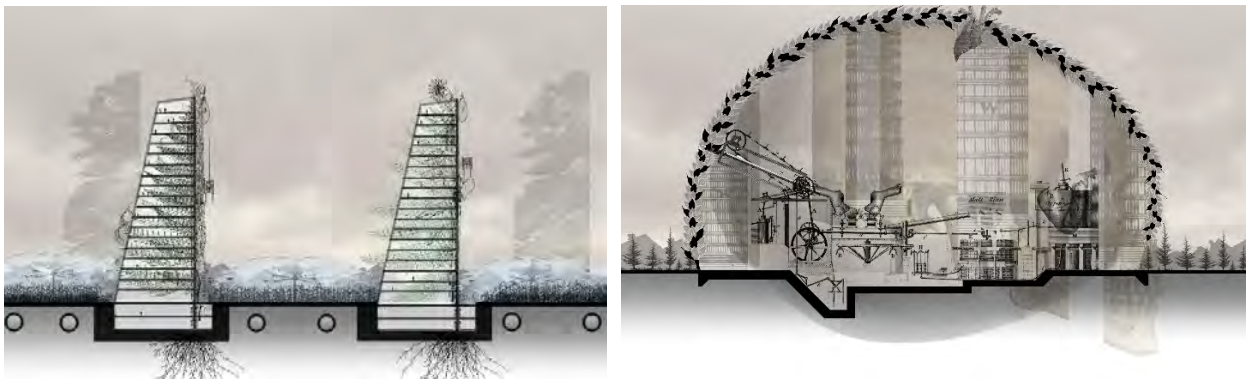

Figure 5: Student Work: urban agricultural production structures. Source: (Lauren Johnson, University of Idaho)

3.5. Programming Ecology

Overdetermined programming is one of the principal causes of the continuing demise of suburban districts such as the one under study here. Single-use zoning at the scale of the city, streets and parking engineered for no purpose beyond the vehicle, and single-use buildings and sites continue to be the primary mode of development. As Anthony Vidler writes, “a contemporary sense of program would imply the radical interrogation of the ethical and environmental conditions of specific sites” (Vidler, p 59). In “Ecology and Design: Parallel Genealogies,” Reed and Lister write, “adaptation, appropriation and flexibility” are “the hallmarks of ‘successful’ systems” and “that an ecosystem’s ability to respond to changing environmental conditions makes persistence possible.” (Reed and Lister, 2014).

Students deployed collage methods to speculate on alternative concepts of public space programming, combining ecological systems, infrastructure, and networked cultural and production spaces. In one studio example, the regional

irrigation system is excavated and revitalized toward new public space networks. In another example, new nodes of agricultural production are imagined as public commons as well as primary locations for energy production and resource renewal. (Figure 6)

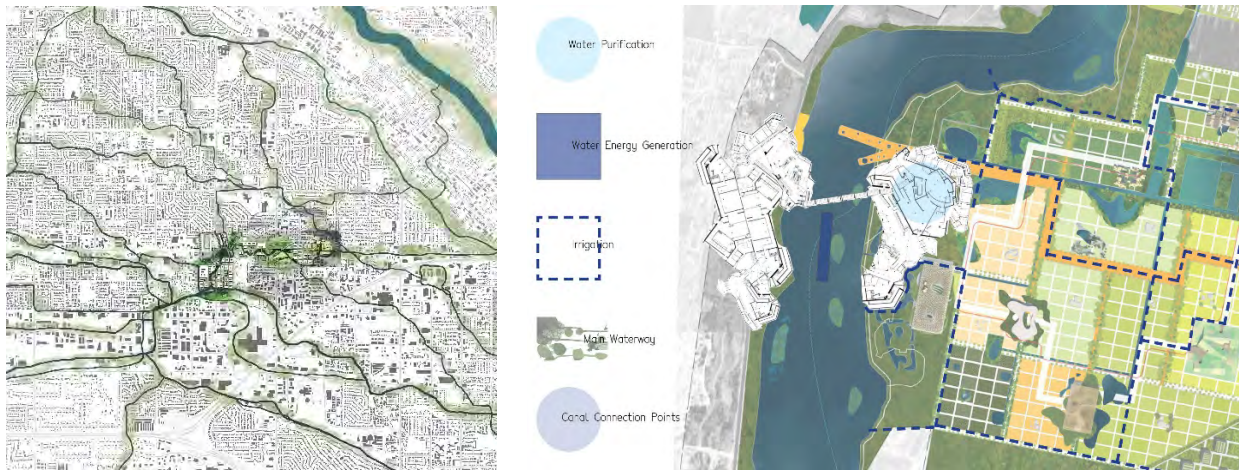

Figure 6: Student Works: Regional Irrigation Network Study; Detail of District Plan, Source: (Samantha Jesser, left; Lyndsay Watkins, right, University of Idaho)

3.6. Tectonics

In “Form without Utopia,” Joan Ockman writes that Rowe’s pedagogical methods, while historically complex, perhaps amounted to little more than “eclectic connoisseurship,” remaining merely a “figure-ground method [...] closer to Beaux-Arts pattern making” (Ockman 1998). The studio attempted to avoid this problem by embracing section.

Building and site design via collaged iterations of appropriated section became a central and favored method of the studio. (Figure 7)

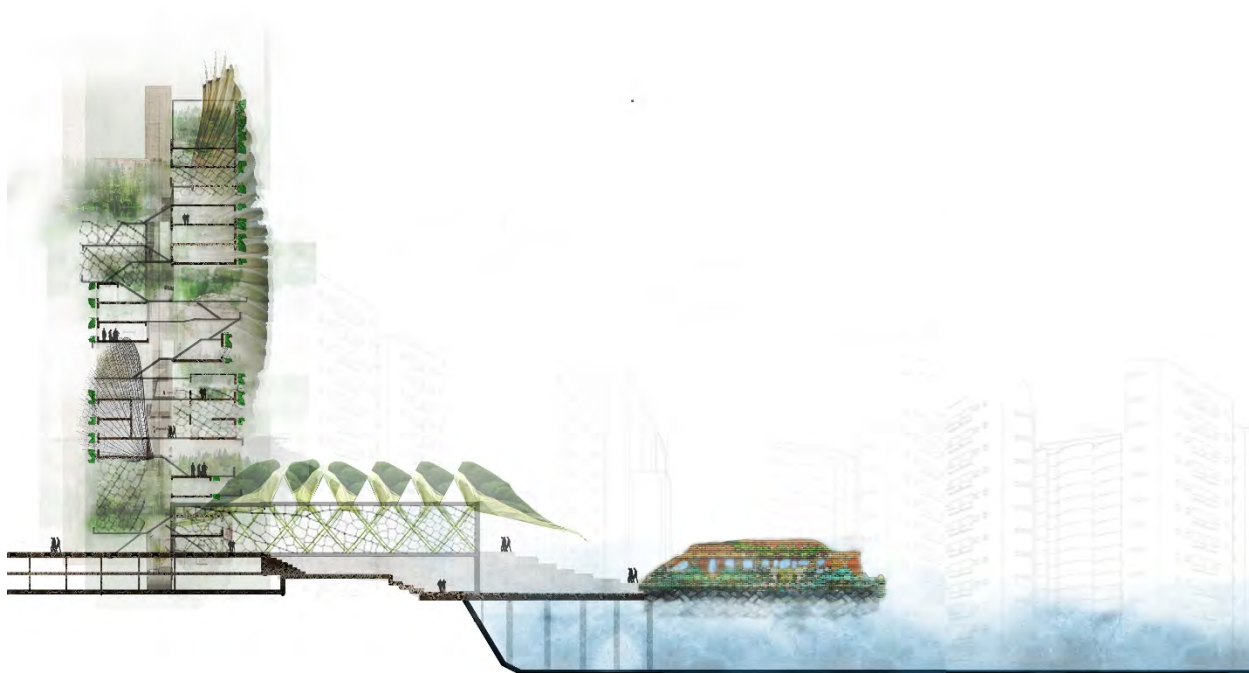

Figure 7: Student Work: Building/Site Section Source: (Samantha Jesser, University of Idaho)

4.0 OUTCOMES

The design methods described above expanded student abilities to inclusively engage history, ecology, and the city at multiple scales. The comments below are based on discussions with guest reviewers, participating students, and my own observations and assessments.

Students, freed from issues of authorship and originality, were seemingly able to query architectural precedents more thoroughly, without 'anxiety,' and to apply that knowledge experimentally. Students reported a sense of deeper understanding of the precedents under study as well as developing abilities to apply and transform discovered elements of urban and architectural design.

Collage techniques enabled students to document, visualize, and incorporate disparate histories into their analytical and design works, testing ideas of heterogeneity and inclusivity through rapid and vivid design experimentation. Students were also able to design and visualize resilient ecological, infrastructural and public spaces at district and building scales.

Engaging appropriation and collage facilitated students' willingness to experiment and take risks. Furthermore, these techniques assisted the students' ability to 'think through history,' utilizing a cultural commons of precedent toward discoveries of individual filiations and projective, communal innovation.

REFERENCES

- Colquhoun, A. 1993. "Architecture as a Continuous Text" New York: *Anyone*: No. 2, *A Tribute to James Stirling*
- Dodds, G. 2011. "Editorial: Re-precedented" *The Journal of Architectural Education (1984-)* 64, no. 2 (2011): 4–5. <http://www.jstor.org/stable/41318772>.
- Gaines, J., Kennedy, S., Pollak, D., Tate, A. 1986. "Precedent and Invention," *The Harvard Architecture Review*, Vol. 5
- Lethem, J. 2007. "The Ecstasy of Influence: A Plagiarism" New York: *Harper's*, 314, no. 1881
- Levine, N. 1998. "The Significance of Facts": Mies's Collages up Close and Personal" *Assemblage*, No. 37. Cambridge, MA: MIT Press
- Maas, W., Madrazo, F., 2017. *Copy Paste: The Badass Architectural Copy Guide*. Rotterdam: nai010 Publishers
- Ockman, J. 1998. "Form without Utopia: Contextualizing Colin Rowe" *Journal of the Society of Architectural Historians*, Oakland, CA: University of California Press
- Reed, C., Lister, N-M. 2014. "Ecology and Design: Parallel Genealogies." *Places Journal*, April 2014 <https://doi.org/10.22269/140414>
- Rowe, C., Koetter, F. 1978. *Collage City*. Cambridge, MA: MIT Press
- Shields, J.A.E. 2014. *Collage and Architecture*. New York: Routledge
- Stierli, M. 2010. "Mies Montage". *AA Files*, 61, 54–72. <http://www.jstor.org/stable/29546066>
- Teal, R. 2011. "Foundational History: An Integrated Approach to Basic Design, History, and Theory" *The Journal of Architectural Education (1984-)* 64, no. 2 (2011): 4–5.
- Vidler, A. 2003 "Toward a Theory of the Architectural Program" *October*, Autumn, Vol. 106. Cambridge, MA: MIT Press

Building Surface Thermal Modulation: Applying Biomimicry and CNC Technologies for Creating Textured Building Façades

Eiman Graiz¹, Keith Van de Riet¹

¹University of Kansas, Lawrence, KS

ABSTRACT: High-performance building facades have become increasingly important in the effort to create sustainable and resilient built environments. In this regard, heat transfer through the building envelope is a growing issue in the building industry, while at the same time, the desire to integrate biomimetics to take advantage of evolutionary traits of natural systems has given rise to the field of biomimicry over the past two decades. This paper investigates the role of 3-axis computer numerical control (CNC) tools and the associated tool paths in creating different textures on architectural surfaces by mimicking natural skin patterns. A systematic process for introducing the tooling was followed to examine the impact of four different textures developed by mimicking the pattern and texture of cactus, elephant, fogstand beetle, and the thorny devil lizard. The study used Rhinoceros 3d software with Grasshopper plug-ins to simulate the performance of the different textures in terms of solar radiation reaching the surface, the exterior sunlight area, and the interior and exterior surface temperatures to calculate the amount of heat transfer through the tiles. The results showed that each texture has a different impact on the panel performance, and depending on climate-based needs, can enhance or deteriorate the performance of a given architectural surface. Textured alternatives succeeded in reducing the outer surface temperature and exterior sunlight compared to the base case of a flat tile. All of the bio-inspired tiles had increased surface area, as well as varying degrees of total solar radiation that reached the surface.

KEYWORDS: CNC machine, texture, biomimicry, thermoregulation, façade tile

1.0 INTRODUCTION

Digital fabrication technologies are widely used in the building industry; they perform quickly and accurately and have opened many new possibilities for high-performance and expressive architectural designs. Computer numerical control (CNC) machines with different tools are commonly used to fabricate building components, such as molds, templates, or direct production of architectural elements like façade tiles. Many designers use CNC milling to produce patterns over facade panels with different materials (Maing and Vargas 2013). Moreover, a building facade pattern or texture has implications for thermal performance and plays an essential role in the amount of solar radiation absorbed or reflected by the envelope, which affects the amount of heat transfer between the building and the surrounding environment.

Research has shown that developing the façade surface geometry can improve the building's thermal performance (Hershovich et al. 2021). In terms of creating surface geometry, biomimicry has proven a fertile source for design ideas and provided the design field a large database of efficient strategies and systems found in nature to improve the design quality and performance (Benyus 1997). Mimicking skin geometries found in nature can be a good source for effective surface textures, particularly where skin textures in nature show interesting strategies to improve the natural organism's performances, such as collecting water, reducing heat, and camouflage with the surrounding environment. For example, elephant skin wrinkles enhance the elephant body thermal performance which inspired Peeks and Badarnah to mimic the wrinkled morphology to improve heat loss capabilities of concrete panels (Peeks and Badarnah 2021). Furthermore, taking inspiration from expressive features found in nature can benefit from digital fabrication tools for complex geometry to achieve optimum building performance (Grobmana and Elimelech 2015). In this regard, CNC machines offer a wide range of textured finishes to apply on flat surfaces, allowing direct cutting or to then cast different types of geometries (Peters 2014). On the other hand, CNC milling machines are considered complex and need a high level of machining knowledge due to the involvement of the tool paths in generating the 3D form. The tool paths can be simply and automatically generated by using CAM software, but it needs a good experience to properly select and manage the milling speed, the tool type (shape and size), depth of the cut, and the finished part geometry, (Weeks, 2012). If harnessed properly, CNC machines could be utilized to mimic the natural skin textures and translate them into tile surface textures, which could affect the resulting form's solar control and thermal performance.

This research paper supports ongoing work to study the effect of texture created by 3-axis CNC tools and tool paths on façade panel thermal performance (paper forthcoming). The earlier study focused on the effect of utilizing basic

CNC tools, tool path, tool stepover, and cutting depth to create the panel texture. Through simulations and experimental work, the tiles were studied for solar radiation and self-shadow cast by the panel itself. Two CNC bits (ball and vee), two tool paths (plunge roughing and parallel), and various tool stepovers were used to create different surface textures. Preliminary tests proved that the panels' textures affected the panel's surface area, increased the amount of self-shadow created by the panel itself, and reduced the solar radiation by 30-56% compared to the flat surface. In the current study, we compounded the tooling to create surface textures that blended the standard tool paths, stepover, and depth of the cuts to better approximate natural skins.

Within this work, we analyzed skin patterns and textures in several organisms to be applied in building envelopes as textures for cladding tiles. Most biomimetic approaches are design-driven, whereas this paper generates surface patterns with the inherent properties of the machine tools. The main objective of this study is to improve the interior thermal comfort by modulating (limiting or enhancing) the amount of heat transfer through the building skin, and this study could help improve building sustainability and energy efficiency with simple but effective façade cladding textures. The findings of this research could support other investigations on digital fabrication and environmental sustainability, and the research will facilitate conducting more studies by following a nature-based approach coupled with CNC technologies. This paper is limited in scope to understand basic form characteristics of surface conditions, while future studies will consider materiality and building systems and technology to expand the understanding of the evolutionary benefits of biomimicry.

2.0 BACKGROUND

Different creatures have evolved different geometrical shapes for their outer skin to adapt to their surrounding environment. This research reviewed literature on the outer skin of the cactus, thorny devil lizard, elephant, and fogstand beetle. Each of these animals' skins' functions could be a source of inspiration to address challenges facing the built environment and facilitate the development of innovative building façade systems.

Cactus skin consists of ribs and spines which can regulate core temperature and keep the plant between 28–37°C (82–98°F) in summer and 16–18°C (60–64°F) in winter. Ribs can increase the cacti surface area up to 80% compared to a smooth cylinder with the same radius. At the same time, they can shade more than 60% of the cacti surface, which is 16% more than a smooth spherical surface (Clifford et al. 2017; Shahda 2020). On the other hand, spines are responsible for decreasing thermal gains through color, concentration, and density of spine tissue. They are a good inspiration for thermoregulation systems in buildings (Clifford et al. 2017). Many researchers were inspired by cactus skin, such as, Clifford et al. which conducted research to develop smart tiles for building envelopes that can change shape by responding to heat and air pressure to alternatively reduce or absorb solar energy to control thermal transmission (Clifford et al. 2017; Laver 2008). Zupan et al. investigated the role of three different patterns inspired by cactus wrinkle patterns on shading the building façade, reducing the façade temperature, and decreasing solar radiation that entered the building (Zupan et al., 2018). All the previous studies on cactus wrinkles showed the benefit of following a biomimetic approach in designing façade patterns and tiles, but the studies did not specifically investigate the role of digital fabrication and surface tooling, which the current study will take into consideration.

Elephants adapted to live in a hot environment where the temperature reaches more than 50°C (Peeks and Badarnah 2021). Heat transfer through the elephant body can be actuated by behavior, such as water spraying, or intrinsically biophysical, such as skin roughness (Myhrvold, Stone, and Bou-Zeid, 2012). Elephant skin is well known for being deeply sculptured by a complicated network of micrometer-width interconnected cracks that help the elephant deal with heat gains (Martins et al. 2018; Weissenbock et al., 2010). Furthermore, wrinkles were shown to provide self-shade and create convective currents, which increase cooling (Martins et al. 2018; Peeks and Badarnah 2021). Moreover, wrinkles encourage evaporation, radiation reflection, and convective heat loss (Badarnah 2017). Elephant wrinkles inspired Peeks and Badarnah to create a set of panels with different textures to study the impact of the surface texture on the heat loss capabilities of concrete panels through evaporative cooling. The results showed that several variables affect heat loss, such as the depth of the texture, surface roughness, and the ratio of surface area to volume (Peeks and Badarnah 2021). The researchers used the CNC machine to create the pattern on the tile surface by using different tool paths. The researchers stated that the patterns created by the CNC machine need more experimentation to clarify their performance. Moreover, this study did not test the self-shade and radiation reflection aspects of the geometry.

Namib desert beetle (Fogstand beetle) shell geometry inspired many researchers to develop different tile surfaces by mimicking the beetle's bumpy shellback. The shell structure consists of bumps on a smooth background, which give the beetle an interesting texture that helps collect water from the fog (Brown and Bhushan 2016; Huang et al. 2018; Bai et al. 2014). Many researchers have taken inspiration from the surface roughness of the fogstand beetle, such as Christian Dorrer and Jurgen Ruh, which stated that the roughness is an important variable in mimicking the beetle, and it should be carefully controlled (Dorrer and Ruh, 2008). As well, Jun Kyu Park and Seok Kim produced a hybrid surface composed of spiky patterns on a flat surface by mimicking the beetle surface. The results showed that the bumpy surface helped to improve the tile performance 16 times better than a flat surface (Park and Kim, 2019). The literature is full of different examples of researchers mimicking the beetle's functional surface to improve water harvesting. Unfortunately, the literature lacks studies on the beetle surface pattern as a form and its role in surface thermal

performance. By mimicking natural skin roughness and transferring it into surface texture, the tile could perform better and function in a more advanced way than the traditional flat surface.

Thorny devil skin consists of spines and scales. Researchers described the geometry of the scales as pentagonal to hexagonal or Voronoi cellular pattern in 2D, while in 3D, the cells overlap to create shaded areas where the moisture harvesting effect happens (Comanns et al. 2014; Aly, Ibrahim, and Abdelmohsen 2021; Comanns 2016). The size of these scales ranges from about 0.07 mm² to 0.33 mm² (Comanns et al. 2014). Some researchers, such as Badarnah and Kadri as well as Aly, Ibrahim, and Abdelmohsen mimicked the water harvesting function of the thorny devil (Badarnah and Kadri, 2015), (Aly, Ibrahim, and Abdelmohsen 2021). Literature has many examples of how to mimic the water harvesting system found in the thorny devil. Unfortunately, there is a lack of studies on the role of skin geometry as a building pattern or texture and its role in heat transfer.

As shown above, many designers tried to develop building systems or components from natural creature skins to improve the building envelope performance by developing tiles for collecting water, cooling, or shading systems. Each precedent studied specific aspects of the architectural application and remains in early stages of development. In general, there is not sufficient evidence about the effect of these skins' geometrical shapes and textures on the building thermal performance, because of the complexity involved in deploying these design ideas and measuring the interaction with the environment. Furthermore, the literature lacks studies on the thermal performance of textures created by following a nature-based approach coupled with CNC technologies. Consequently, this research will study relevant skin morphologies and patterns in nature and connect them into CNC surface tooling in order to create textured surfaces.

3.0 METHODOLOGY

Skin patterns can be simplified and converted into geometrical shapes using CNC tools and tool paths (Figure 1). This study investigated changing the flat smooth surface tiles into textured ones to beneficially impact the thermal performance of the surface.

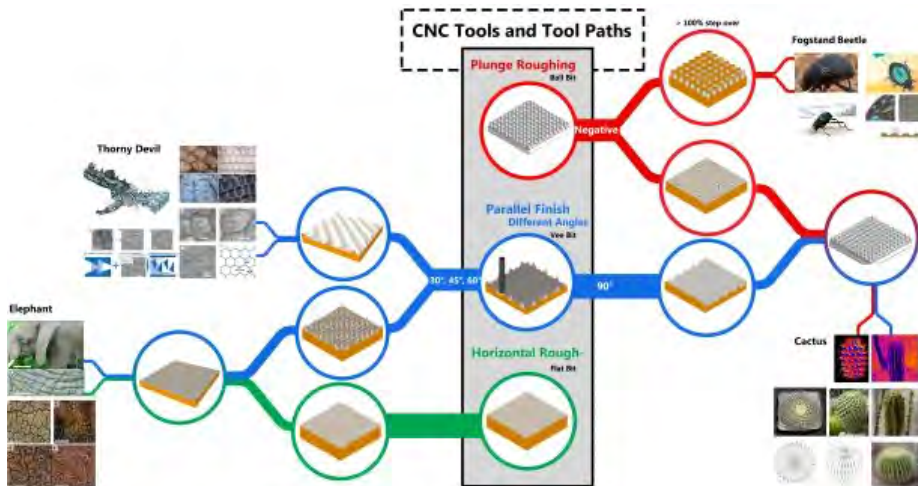

Figure 1. The role of CNC tools and tool paths on creating surface textures by mimicking natural skins. In the middle, the different tools and tool paths used for this study. On the left and the right, the panels' surface textures compared to the natural skins' textures.









The 3-axis milling machine has a good variety of tools and tool paths which enables variations on a single design to result in a different textured finish. Vee and ball bits were selected to conduct this study. The selected tool follows a specific route to cut a specific design, which is known as a tool *path*. The tool *stepover* can be defined as the distance the cutting tool moves away from the previous cutting path which controls both the depth and the width of the cut. It can be increased or decreased to give more finishing options and more or less surface details.

Tool paths can be manipulated and compounded to achieve hybrid and composite patterns that reflect nature in appearance and performance. RhinoCAM converts the design to what is known as a "tool path code," which converts the design to data and actuations which control the CNC machine (Putro, 2019). RhinoCAM enables the user to simulate the texture created by different tool paths. Each operation can be modified by manipulating several factors, such as tools, tool stepover, and cut angle. Using one operation can result in a specific type of face cut and texture, while combining more than one operation can lead to a more complex surface texture. For example, using a parallel finish with 90° cut angle can produce a simple surface cut that appears similar to louvers, whereas conducting another operation above the previous one with 45° can produce a different surface texture. Adding more complexity, we can run another operation with different tool paths over the previous ones, such as radial or plunge roughing paths, producing a more complex pattern that can reflect different textures found in nature.

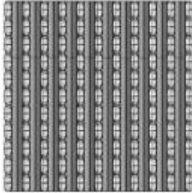
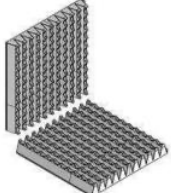
This research methodology followed an ongoing experimental methodology, which mapped textures created by the CNC tools and tool paths on cast concrete panel surfaces to determine their roles in increasing or decreasing the amount of solar radiation and self-shaded areas of tiles. As a component of this broader area of research, this paper used McNeel and Associates Rhinoceros 3d software (Rhino) with different plug-ins to design and simulate the tested panels, such as MecSoft Corporation RhinoCAM to simulate the milling process, McNeel and Associates Grasshopper algorithmic modeling for Rhino (Grasshopper) to design the tested panels, Ladybug Tools (Ladybug) and ClimateStudio to run the solar and energy study.

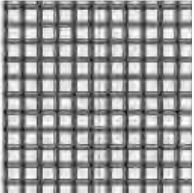
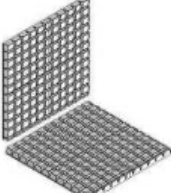
The first step for this study was to simplify the natural skin patterns and create panel textures by running a simulation in RhinoCAM /Rhino and rebuild them with Grasshopper (Table 1). Tools and tool paths were selected from the previous study (vee and ball bits and the negative version of the plunge roughing and parallel finish paths) in addition to the horizontal roughing path. 90% stepover for the tools was used to create and test the performance of the texture created on four 12.7 x 12.7 cm (5x5in) tiles.

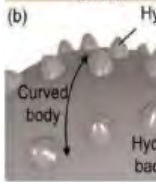
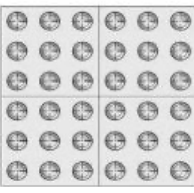
Table 1. CNC tools and tool paths and their role in simplifying the natural skin patterns to become texture on the tile's surfaces.

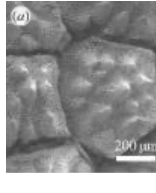
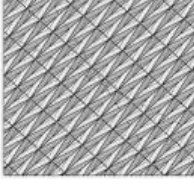
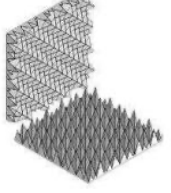
Creature	Skin	Grasshopper tile top view	CNC Tool	CNC Path	Grasshopper 3D tile
			Vee bit 30° and Ball bit Vee bit 60° and Ball bit	Parallel finish and Plunge roughing paths	
			Vee bit 60 with angle cut 0° and 90 and flat ° bit	Horizontal roughing and parallel finish	
			Ball bit with 200% stepover	Plunge roughing path (Negative)	
			Vee bit 30° Vee bit 60°	Parallel finish path 60° and 30°	

We used the Ladybug plug-in to simulate the annual solar radiation and exterior sunlight area. In addition, ClimateStudio was used to simulate the exterior and interior surface temperatures for the selected panel surfaces by applying regional weather data. We calculated the thermal transmittance through the tiles by following this equation: $\Phi = A \times U \times (T_1 - T_2)$, where Φ is the amount of the transmitted heat, A is the surface area, U is the material u-value, T_1 is the exterior surface temperature, and T_2 is the interior surface temperature (Shahda 2020). The results were compared with a flat panel surface. Furthermore, concrete material was selected for this study due to its availability, low cost, adaptability to a wide spectrum of performance requirements, low environmental footprint, and low embodied energy (Meyer 2005; Lloret et al. 2015). Moreover, concrete can be considered a sustainable construction material due to its performance criteria, strength, and durability (Djamil 2017). 200mm concrete with 120mm XPS board insulation with a u-value of 0.263 W/m²k was assigned for the panels to calculate the heat transfer. Future work will expand upon the material selection, particularly as it is applied to biomimetic designs.

4.0 SIMULATION RESULTS

4.1 Cactus Texture

After running the RhinoCAM simulation, the closest texture for the natural cacti skin could be created by using both vee bit 30° or 60° and ball bit with 90% stepover and a combination between parallel finish and plunge roughing paths (Figure 2). The panel surface area was 420 cm² (65.1 in²) using vee 30° and 250 cm²(38.7 in²) using vee 60° which were 2.6 and 1.6 times the area of the flat surface area. The annual total solar radiation on the cactus panel 30° was 49.2 Kwh for the vertical orientation and 50.5 Kwh for the horizontal orientation. While for cactus 60°, the total radiation was 36.9 and 38.2 kwh for vertical and horizontal orientations respectively. When assessing a patch of landscape, “full sun” exposure can be defined by any area with six or more hours of direct sun per day (2190h annually). This definition was used to describe the exterior sunlight area in this paper. The surface area of cactus 30° and 60° within the direct sunlight reached 61.9% and 53% of the total panel surface area. The exterior and interior annual average temperatures were 14.4°C and 20.4°C for cactus 30° and 15.3°C and 20.7°C for cactus 60°.

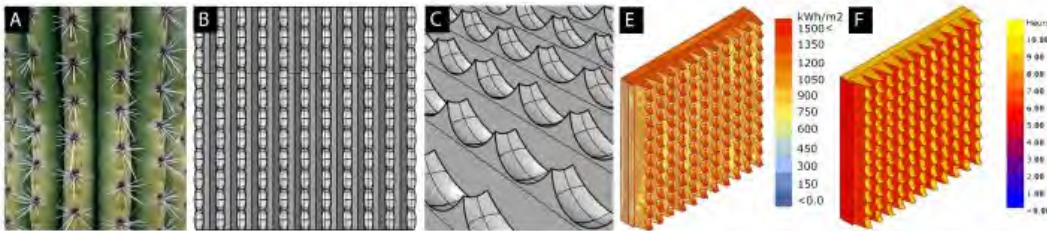

Figure 2. A) the cactus skin, B) the panel surface texture. C) detail view of the panel's texture. E) the result of the solar radiation simulation. F) the result of sunlight simulation.

4.2 Elephant Texture

Vee bit 30° with 0° and 90° cut angles and 90% stepover with a combination between horizontal roughing and parallel finish paths were the best choice to simplify the geometry of the elephant's wrinkles (Figure 3). The panel surface area was 380 cm² (58.9 in²) which was 2.3 times the area of the flat surface. The panel's annual total solar radiation was 46.2Kwh for the vertical orientation and 46.8 Kwh for the horizontal orientation. The sunlight area percentage reached 81.5% of the total surface area, while the average annual exterior and interior surface temperatures were 17°C and 21°C, respectively.

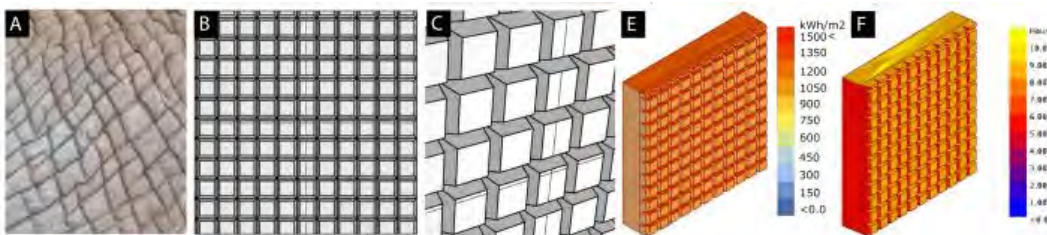

Figure 3. A) the elephant skin, B) the panel surface texture. C) detail view of the panel's texture. E) the result of the solar radiation simulation. F) the result of sunlight simulation.

4.3 Fogstand Beetle Texture

The preferred approach to mimic the bumpy textures was using a ball bit with a 200% stepover with the negative (inverse cast of the cut panel) plunge roughing path (Figure 4). The panel surface area is 200 cm² (31 in²), slightly higher than the flat surface area. The panel's annual total solar radiation was 31.7 Kwh for the vertical orientation and 34.2 Kwh for the horizontal orientation. The sunlight area reached 70% of the total surface area. The energy simulation by ClimateStudio did not give an accurate result for the surface energy performance regarding a defect with energy plugins when dealing with bumpy surfaces (plugin removed the bumpy surfaces and gave a fraction of desired results).

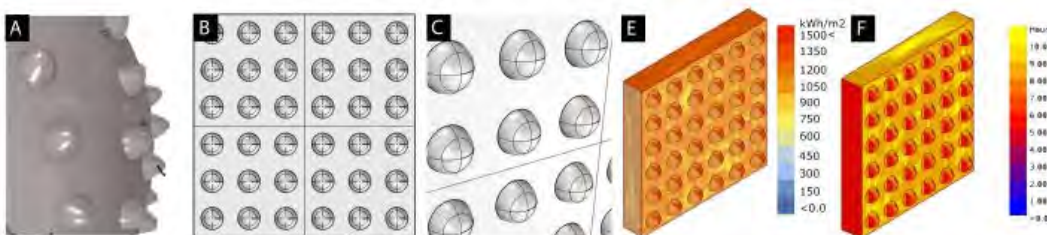

Figure 4. A) the Fogstand beetle skin, B) the panel surface texture. C) detail view of the panel's texture. E) the result of the solar radiation simulation. F) the result of sunlight simulation.

4.4 Thorny Devil Texture

3-axis CNC technologies are limited in achieving a true overlap to the extent described in nature. Vee bit 30° or 60° with 90% stepover and 60° and 30° cut degrees with parallel finish path were the preferred choice to simplify the geometry of the thorny devil scales (Figure 5). The panel surface areas were 620 and 320 cm² (96.1 and 49.6 in²) by vee 30° and 60° respectively, which were 3.8 and 1.9 times the flat surface area. The annual total solar radiation that reached the thorny devil 30° was 63.0 and 61.8 Kwh for the vertical and horizontal orientations, while the exterior sunlight area reached 51% of the total surface area. In contrast, thorny devil 60° received 42.3 and 42.8 Kwh for the vertical and horizontal orientations and 50% of exterior sunlight. While the surface temperatures were 14.2 °C and 14.9 °C for the exterior surfaces and 20.2°C and 20.3°C for the interior surfaces for thorny devil 30° and 60° respectively.

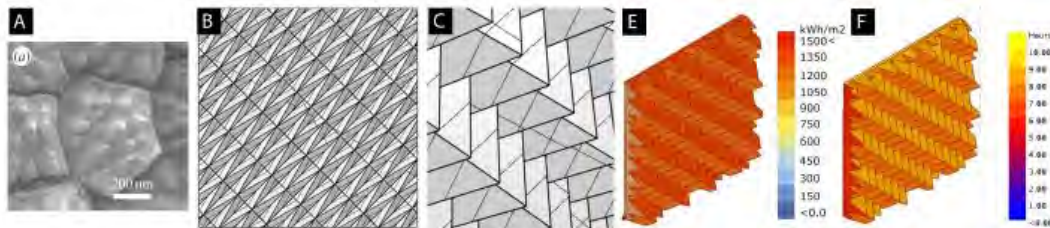

Figure 5. A) the Fogstand beetle skin, B) the panel surface texture. C) detail view of the panel's texture. E) the result of the solar radiation simulation. F) the sunlight simulation.

5.0 DISCUSSION

Surface textures can increase the surface area, provide shade, and disperse the heat on the building façade. The surface area for all the tested panels with textures was higher than the flat tile. The panels had different surface areas depending on the tool and the tool path types since they affect the depth of the texture. Textures created by vee 30° bit had the largest surface area regarding the depth of the cut, where thorny devil 30° and cactus 30° had the largest surface areas, which reached 3.8 and 2.6 times the flat surface area (**Error! Reference source not found.. A**). These were followed by elephant tile, thorny devil 60°, and cactus 60° respectively, while the beetle tile had the lowest surface area which was slightly higher than the flat tile surface area. Fogstand beetle tile texture was not very dense where the tool stepover was 200%, which meant the panel surface had a high percentage of flat zones.

Textured surfaces can affect the amount of solar radiation reflected or absorbed by the panel. Each panel received a different amount of annual total solar radiation for horizontal and vertical orientations. In general, all tiles received more annual solar radiation than the flat tile, except the beetle tile, which received nearly the same amount as the flat one. On the other hand, elephant and thorny devil tiles received a high amount of radiation and the cacti tile received a moderate amount (**Error! Reference source not found.. B**).

Exterior and interior surface temperatures are essential when dealing with heat transfer. Creating texture on the panel surface means creating two main zones on that surface; the first one is directly exposed to the sun, and the second zone is shaded by the texture itself, which could reduce the temperature for that area. Cactus and thorny devil tiles have textures created by vee 30°, and 60° registered exterior surface temperatures lower than the flat one by 2-3 degrees. In comparison, the elephant tile exterior surface registered a temperature equivalent to the flat one. Despite this variation, the interior surface temperature remained almost the same for all tiles, where cactus and thorny devil tiles temperatures were slightly lower than the rest of the tiles (Figure 6. C). The fogstand beetle tile was excluded in this section regarding the fact that no result was registered due to a software defect.

The textured tiles have zones directly exposed to the sun and shaded or partly shaded zones. The nature of the surface texture plays an essential role in the exposed exterior sunlight and the self-shaded area. Most of the tile surface areas received more sunlight than shadow. 81% of the elephant's tile and 70% of the beetle's tile area received direct sunlight. In contrast, Thorny devil 30° and 60° had the lowest exterior sunlight area, which reached 50% of the total surface areas. At the same time, 61% and 53% of cactus 30° and 60° exterior surfaces received sunlight (Figure 6. D).

The amount of heat transferred through tiles depends on the tile surface area, the U- value of the tile's material, and the temperature difference between the interior and exterior sides of the tile. Heat transfer in this paper was calculated by the following equation $\Phi = A \times U \times \Delta T$. To reduce heat transfer, we could reduce one or more of the previous variables. The heat transfer through the tested tiles was variable depending on the texture type. In general, all tiles had higher heat transfer than the flat tile since all the tile surface areas were higher than the flat one and the reduction of ΔT was not significant (**Error! Reference source not found.**). The simulation was repeated for solstices and equinoxes to get a precise result. The total solar radiation, surface temperature, and sunlight percentage were simulated again. The results showed that the tiles performances pattern was almost the same as the annual performance pattern.

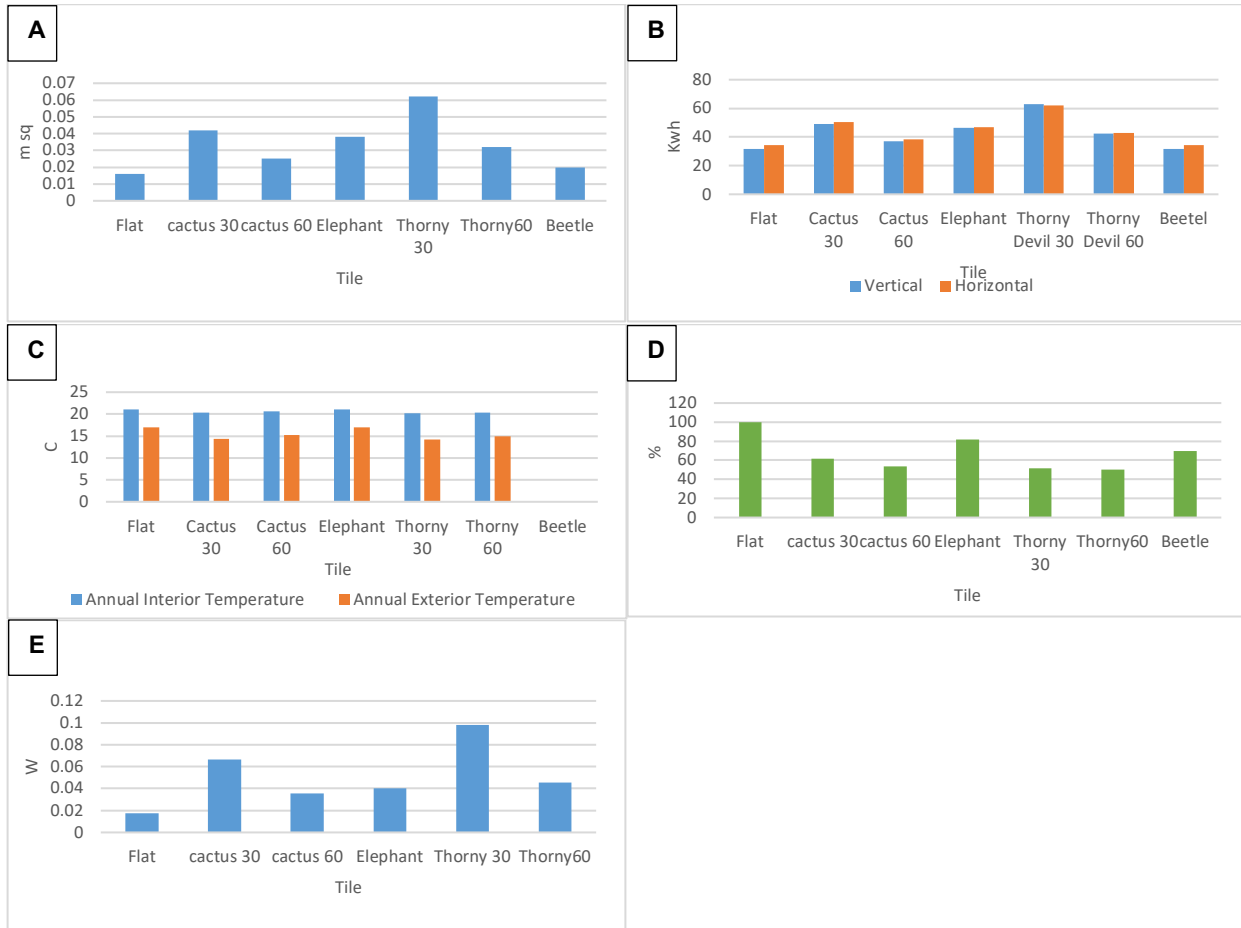

Figure 6. A) the tested tiles' surface areas. B) the annual total solar radiation for each panel for horizontal and vertical orientations. C) average annual interior and exterior surface temperatures. D) the annual percentage of exterior sunlight area for each tile. E) the annual heat transfer through different tiles and textures

6.0 CONCLUSION

There is growing evidence that mimicking natural skin roughness and transferring it into façade cladding tiles can enhance building performance over that of traditional flat building facades. This research showed that CNC tools, and perhaps digital technologies in general, can approach facsimiles of natural skin patterns by converting flat surfaces into textured geometries. Each texture can perform in a specific way and could be efficient in different environments. To control heat transfer through building façade with different textures, designers should pay attention to the surface area, the difference between interior and exterior surface temperature, and the U-value for the tile's material. To maximize the reduction of heat transfer, the tile texture should have the lowest value for these three variables, unless heat gain is considered desirable within certain climate conditions.

Surface texture reduced the exterior surface temperature up to 3°C, while the interior surface temperature witnessed a slight reduction. On the other hand, the surface area was higher for all tiles with texture. Accordingly, the heat transfer through these tiles was higher than the flat surface. Ultimately, using CNC technology to mimic natural textures helped to reduce the exterior temperature of the panels, increase the self-shaded area, and add aesthetic value and visual effect to the panels. However, creating these complicated textures can be challenging due to the machining time required to create these textures which could question the feasibility of the panels. Simulation tools have become increasingly accessible to designers, but heat transfer in buildings and the environment are complex phenomena that are approximated with these optimized plug-ins. In the case of surface texture, the simulations showed a variety of results from the different textures that would potentially be impacted by conductive and convective heat exchange. The simulation tools offer little insight into this level of functionality and may require additional tools to study the effects of heat exchange to more fully understand the advantages and disadvantages of the various textures. In addition to expanding the suite of simulations for heat exchange, future work will include physical prototyping and testing of the biomimetic tiles with a thermal camera and heat flux sensors to document the tile thermal behavior and better understand the role of texturing panels in building energy consumption for cooling and heating. In addition, further studies to reduce ΔT and surface area to the minimum would decrease the heat transfer to the minimum.

REFERENCES

- ALY, Z., IBRAHIM, A., AND ABDELMOHSEN, S. 2021. AUGMENTING PASSIVE ACTUATION OF HYGROMORPHIC SKINS IN DESERT CLIMATES: LEARNING FROM THORNY DEVIL LIZARD SKINS. 9TH INTERNATIONAL CONFERENCE OF THE ARAB SOCIETY FOR COMPUTER AIDED ARCHITECTURAL DESIGN (ASCAAD) 2021.
- BADARNAH, L. 2017. FORM FOLLOWS ENVIRONMENT: BIOMIMETIC APPROACHES TO BUILDING ENVELOPE DESIGN FOR ENVIRONMENTAL ADAPTATION. *BUILDINGS* 7 (40): 1-16.
- BADARNAH, L., AND KADRI, U. 2015. A METHODOLOGY FOR THE GENERATION OF BIOMIMETIC DESIGN CONCEPTS. *ARCHIT. SCI. REV.* 58 120–33
- BAI, H., WANG, L., JU, J., SUN, R., ZHENG, Y., JIANG, L. 2014. EFFICIENT WATER COLLECTION ON INTEGRATIVE BIOINSPIRED SURFACES WITH STAR-SHAPED WETTABILITY PATTERNS. *ADV. MATER* 26 (29): 5025–5030.
- BENYUS, JANINE. 1997. *BIOMIMICRY: INNOVATION INSPIRED BY NATURE*. HARPER PERENNIAL.
- BROWN, P., BHUSHAN, B. 2016. BIOINSPIRED MATERIALS FOR WATER SUPPLY AND MANAGEMENT: WATER COLLECTION, WATER PURIFICATION AND SEPARATION OF WATER FROM OIL. *PHILOSOPHICAL TRANSACTIONS OF THE ROYAL SOCIETY A: MATHEMATICAL, PHYSICAL AND ENGINEERING SCIENCES* 374 (2073).
- CLIFFORD, D., ZUPAN, R., BRIGHAM, J., BEBLOW, R., WHITTOCK, W., AND DAVIS, N. 2017. APPLICATION OF THE DYNAMIC CHARACTERISTICS OF SHAPE-MEMORY POLYMERS TO CLIMATE ADAPTIVE BUILDING FACADES. IN WILEN: ADVANCED BUILDING SKINS GMBH. 12TH CONFERENCE OF ADVANCED BUILDING SKINS. 171–178. BERN, SWITZERLAND.
- COMANNS, P., EFFERTZ, C. HISCHEN, F., STAUDT, K., BÖHME, W., AND BAUMGARTNER, W. 2011. MOISTURE HARVESTING AND WATER TRANSPORT THROUGH SPECIALIZED MICRO-STRUCTURES ON THE INTEGUMENT OF LIZARDS. *BEILSTEIN J. NANOTECHNOL* 2: 204–214. DOI: [HTTP://DX.DOI.ORG/10.3762/BJNANO.2.24](http://dx.doi.org/10.3762/bjnano.2.24)
- GROBMAN, Y., AND ELIMELECH, Y. 2015. MICROCLIMATE ON BUILDING ENVELOPES: TESTING GEOMETRY MANIPULATIONS AS AN APPROACH FOR INCREASING BUILDING ENVELOPES' THERMAL PERFORMANCE. *ARCHITECTURAL SCIENCE REVIEW* 59(4): 269-278.
- HERSHCOVICH, C., HOUT, R., RINSKY, V., LAUFER, M., AND GROBMAN, Y. 2021. THERMAL PERFORMANCE OF SCULPTURED TILES FOR BUILDING ENVELOPES. *BUILDING AND ENVIRONMENT* 197.
- HUANG, Z., LIU, X., WU, J., WONG, S., AND QU, J. 2018. ELECTROSPINNING WATER HARVESTERS INSPIRED BY SPIDER SILK AND BEETLE. *MATERIALS LETTERS* 211: 28-31.
- LAVER, J. 2008. HIGH PERFORMANCE BUILDING ENVELOPES. MASTER THESIS: UNIVERSITY OF ARIZONA.
- MAING, M., AND VARGAS, R. 2013. DIGITAL FABRICATION PROCESSES OF MASS CUSTOMIZED BUILDING FACADES IN GLOBAL PRACTICE. XVII CONFERENCE OF THE IBEROAMERICAN SOCIETY OF DIGITAL GRAPHICS - SIGRAFI: KNOWLEDGE-BASED DESIGN. 415-419. VALPARAISO, CHILE.
- MARTINS, A., BENNETT, N., CLAVEL, S., GROENEWALD, H., HENSMAN, S., HOBY, S., JORIS, A., MANGER, P., AND MILINKOVITCH, M. 2018. LOCALLY-CURVED GEOMETRY GENERATES BENDING CRACKS IN THE AFRICAN ELEPHANT SKIN. *NAT. COMMUN* 9:1–8.
- MYHRVOLD, C., STONE, H., AND BOU-ZEID, E. 2012. WHAT IS THE USE OF ELEPHANT HAIR?. *PLoS ONE* 7 (10): e47018.
- PARK, J, AND KIM, S. 2019. THREE-Dimensionally Structured Flexible Fog Harvesting Surfaces Inspired by Namib Desert Beetles. *MICROMACHINES* 10(3): 201-211.
- PEEK, M., AND BADARNAH, L. 2021. TEXTURED BUILDING FAÇADES: UTILIZING MORPHOLOGICAL ADAPTATIONS FOUND IN NATURE FOR EVAPORATIVE COOLING. *BIOMIMETICS* 2021 6 (2).
- PETERS, B. 2014. ADDITIVE FORMWORK: 3D PRINTED FLEXIBLE FORMWORK. *ACADIA 14: DESIGN AGENCY*, LOS ANGELES.
- SHAHDA, M. 2020. SELF-SHADING, BRICK, GEOMETRIC PATTERNS, ENVIRONMENTAL PERFORMANCE, DESERT BUILDINGS, ORIENTATION. *ARCHITECTURE RESEARCH* 10(1): 1–14.
- WEEKS, K. 2012. FABRICATING A FUTURE ARCHITECTURE. MASTER THESIS. UNIVERSITY OF MASSACHUSETTS AMHERST
- ZUPAN, R., CLIFFORD, D., BEBLO, R., AND BRIGHAM, J. 2018. NUMERICAL INVESTIGATION OF CAPABILITIES FOR DYNAMIC SELF-SHADING THROUGH SHAPE CHANGING BUILDING SURFACE TILES. *JOURNAL OF FACADE DESIGN AND ENGINEERING*, 6(1): 57-69.

Enabling Structural Resolution in Architectural Design Studio Using Karamba3D

Chengde Wu¹, David Thaddeus², Danielle Scaccia²

¹Iowa State University, Ames, IA

²University of North Carolina at Charlotte, Charlotte, NC

ABSTRACT: Structural analysis is an integral part of architectural design. It is not uncommon, however, that architecture students pay little attention to the demands of strength and stability in their studio designs. This is largely due to the fact that they often have difficulty applying structural knowledge that they acquired in lecture courses to their own projects. As the geometries of their design become more complex, the challenge of demonstrating structural knowledge grows exponentially. While several structural software applications exist, most have a steep learning curve and are not conducive for use in the studio environment. In our research, we investigated a design process that helps the integration of structural analysis into studio projects by exploring the potentials and limitations of Karamba3D, a structural plugin for the Rhino/Grasshopper platform. Despite the user-friendliness and analytical capabilities of Karamba, we identified three challenges that hinder incorporating structural elements into architectural design. The first challenge is the need to manually remodel each structural member as a Free Body Diagram. This process is labor-intensive and may create unintended errors. We devised a method to automatically generate structural members based on building massing (shell), reference levels, and column spacing. Another challenge is that Karamba optimizes all beam sizes to a single maximum allowable deflection which conflicts with building codes that specify allowable deflection as a variable function of span. In a structural system with different spans, Karamba oversizes longer beams to make them code-compliant. To address this limitation, we developed a method that optimizes the size of each beam based on its span. The last challenge is the incongruence of the structural model and visualization model. Students need to manually edit the structural members generated from Karamba to represent the correct location and details of the beams and columns. We developed a visualization module that automatically adjusts the location and details of the beams and columns. The methods developed in this study enhance the capability of Karamba and help architecture students integrate structure into their design projects.

KEYWORDS: Structural analysis; Structure-design integration; Parametric design; Karamba3D; Structure optimization

INTRODUCTION

Architectural education has been in a state of perpetual flux for many centuries; but never as much as recently, or maybe it just seems that way since we are living the change. The ancient Greek philosophers pondered the differences between *episteme* (theory and knowledge) and *techne* (the practice of art or craft) (Parry 2021). Both *techne* and *episteme* are persistent in architectural education, albeit following the ebb and flow of changing times.

The painter and architect Giorgio Vasari described Filippo Brunelleschi, the father of Renaissance architecture, by writing that “*Brunelleschi was sent by Heaven to invest architecture with new forms, after it had wandered astray for many centuries*” (Hughes 2012). Much like Brunelleschi descended from the heavens to breathe new form and chart new directions in architecture, science and engineering were undergoing a renaissance of their own. Theirs was separated from the world that united architecture and engineering. Galileo, Newton, Hooke, Kepler and many others were luminaries in a scientific revolution that eventually led to the First and Second Industrial Revolutions.

The Gothic and Renaissance Master Builders accumulated much of their knowledge by apprenticing with skilled craftsmen and experienced builders. They developed intuition and experience that illuminated every aspect of their work. Architecture, engineering, and construction were *practiced* in the field instead of *taught* in the classroom. This is when *episteme* and *techne* were practiced simultaneously and by the same masters.

Engineering calculation of stability, strength and stiffness was not formalized into building statics until the 17th Century and were not formally taught in the academy until the 18th Century (Magyar 2021). This ushered in a permanent split between the *techne* world of engineers and the *episteme* world of architects. Later, in the late nineteenth century, architectural education became mostly influenced by L'École des Beaux Arts. L'École introduced “architectural parlance” or speaking architecture with an emphasis on the art of architecture including rapid conceptual sketches, perspective drawings, urban and social contexts.

1.0 STRUCTURAL ANALYSIS IN DESIGN STUDIO TODAY

In architectural education today, incorporating structural analysis and member sizing into the schematic phase of architectural design remains a challenge for students and instructors alike. The student does not typically have the requisite experience or intuition to determine if a structural system and size are appropriate. Often structural determination in the design studio is forgone in favor of further exploration of formal investigation. There is an increasing gap between architectural design and allied disciplines as architectural education shifts toward episteme and away from *techne*. This is further exacerbated by the demands of modern architectural education including attention to energy conservation, sustainability and digital literacy. For many students, structural knowledge specifically, remains confined in the lecture course and does not infiltrate the design studio often enough.

Advances in digital technology promise to provide interactive metrics and feedback loops for preliminary design iterations. New forms that have been inspired by the proliferation of digital innovations are challenging to the human mind and require commensurate digital tools to visualize and analyze. Parametric geometries are creating architectural forms that are increasingly difficult to visualize, analyze, and represent using traditional architectural methods. Gone are the days of the “back of the envelope” calculations and with that went intuition and experience. The creation of new geometric forms has far out-paced the ability to analyze them and tends to follow Moore’s Law of exponential growth. This is the law which predicts that smaller, faster and more powerful computer chips will be produced every two years with an even cheaper cost to produce. Developments in technology have exceeded Moore’s predictions but the ability to keep up with the speed of change has lagged behind. Students are quick to adopt new trends in computing but are slower to understand how they may become realized as works of architecture instead of remaining provocations in visual art.

Many innovative plugins for modeling software have recently informed and improved the performance of architectural design. With an ever-increasing commitment to sustainability and green architecture, the interest in software plugins for energy modeling and performance continues to rise. Plugins for energy simulation in Rhino/Grasshopper abound including apps such as Honeybee/Ladybug, Climate Studio, Cove.Tool, etc. These tools are readily adopted by students since they are already familiar with the digital environment of Rhino/Grasshopper. Simple and basic visual scripting has created an iterative process of form-making that allows rapid investigation and optimization of form.

The near absence of structural determination in studio projects may be for several reasons. Structural analysis involves several layers of information that are interrelated and may not be separated or considered independently. The field of variables in structural analysis is vast and may not be fully determined at the schematic stage of the design. There is a steep learning curve for much of the existing structural software that is on the market which makes it rather unlikely to be adopted by students in the architecture design studio. There is great promise in the software applications and plugins developed by the Digital Structures research group and the StructureFIT software being developed at the Massachusetts Institute of Technology (MIT) (Agenda 2021). There remains a dire need for intuitive and user-friendly software that does not require programming, one that can visually analyze the complex geometry of parametric forms.

With the development and proliferation of parametric software in architectural education, the use of visual and user-friendly finite element software such as Karamba3D (Karamba for short below) is a natural outcome (Karamba3D 2021). Instead of migrating a student design into a structural software, Karamba is compatible with and uses the same platform in which the architectural design was created. This makes the structural analysis of a design much more accessible and enables the user to manipulate outcomes to reach an optimum solution more readily. Energy and environmental software applications within the Rhino/Grasshopper platform have a headstart over structural applications. It is all but certain that Karamba and others will soon narrow the lead of environmental plugins and provide much needed structural feedback loops for preliminary architectural design. In this study, we acknowledged the advantages of Karamba and analyzed the challenges of applying Karamba seamlessly in design studio projects. The goal of this research is to formulate a process that students in architectural design programs can easily integrate structural analysis in their design studio projects

2.0 INTEGRATING STRUCTURAL ANALYSIS INTO DESIGN STUDIO WITH KARAMBA-3D

Karamba is built on the Rhino/Grasshopper platform which is one of the most popular modeling platforms for architecture students. The sheer fact that Karamba runs on the same platform that students model their buildings grants Karamba great potential to be used by the students to integrate structural analysis into design studio design. Unlike learning other structural analysis applications that run independently from popular architectural modeling platforms, students are able to run simple structural analyses in Karamba with just one or two hours of instruction.

However, students’ projects in the design studio are often much more complex than the simple shoebox models that they use to learn structural analysis in Karamba. As a result, students are rarely able to conduct structural analyses in any software applications, so they mostly rely on their intuition or through consultation with their structures professor. Upon closer investigation, despite its great potential, Karamba poses several challenges that impede students from easily integrating structural analysis into their design projects as geometries become more complex. The following explains the challenges in detail with corresponding solutions that can overcome the challenges.

2.1. Challenge 1: Parametrically modelling structural members for large buildings is difficult

A typical design studio project can easily have hundreds of beams and columns. Students often encounter the following issues when modeling structural members in Grasshopper at this scale. If students use simple data structures such as lists (1D) or simple trees (i.e., 2D arrays), it is time-consuming to model all the members and often ends up with a large number of batteries. Figure 1 shows a student's structural model for a two-story, two-bay by two-bay building. The Grasshopper definition on the right side of the figure shows a huge number of batteries. The critical problem of using a simple data structure is that the model could easily lose its parametric capability, i.e., as the size of the building gets larger, the number of the batteries in Grasshopper grows proportionally. As a result, students can easily lose track of managing the Grasshopper definition. Nonetheless, students often choose the simple data structure because it is easier to understand and apply. In comparison, 3D or even 4D data structures (e.g., 3D/4D arrays or trees with deeper branches) are far superior in parametrically generating and processing models. Figure 2 shows a Grasshopper definition that generates a similar structural model but with 3D data structure. As shown on the right side of Figure 2, the Grasshopper definition has a much smaller number of batteries and is still able to parametrically scale up the model (to ten stories in the example). However, students often demonstrate difficulties in understanding 3D/4D data structure or applying them to arrange the data in specific ways due to the abstract nature of the higher dimension data structure. These difficulties have been the primary deterrent for students to seamlessly incorporate structural analysis into their design projects.

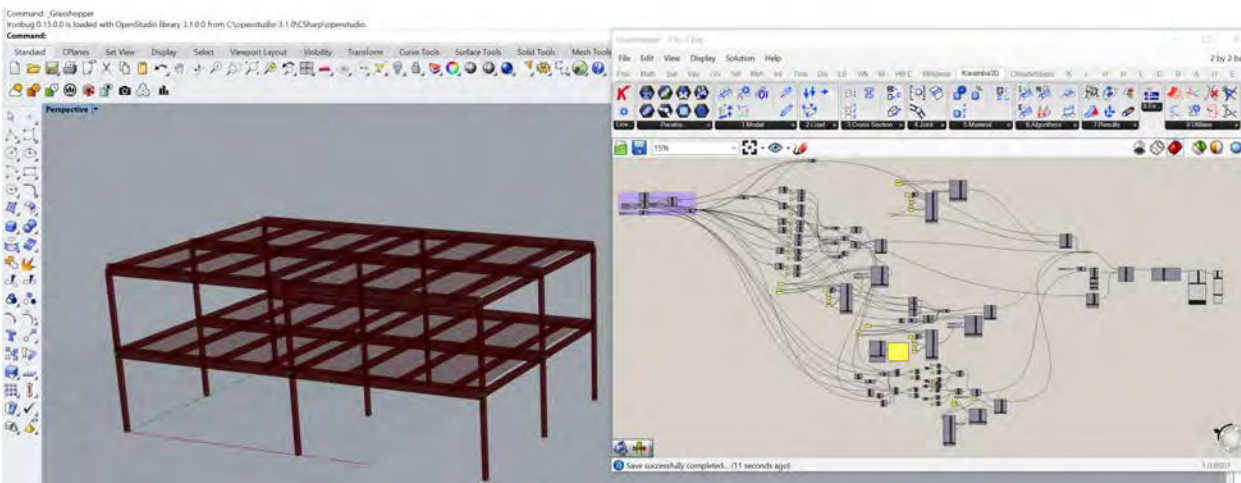

Figure 1: A structural model with mostly lists as its data structure.

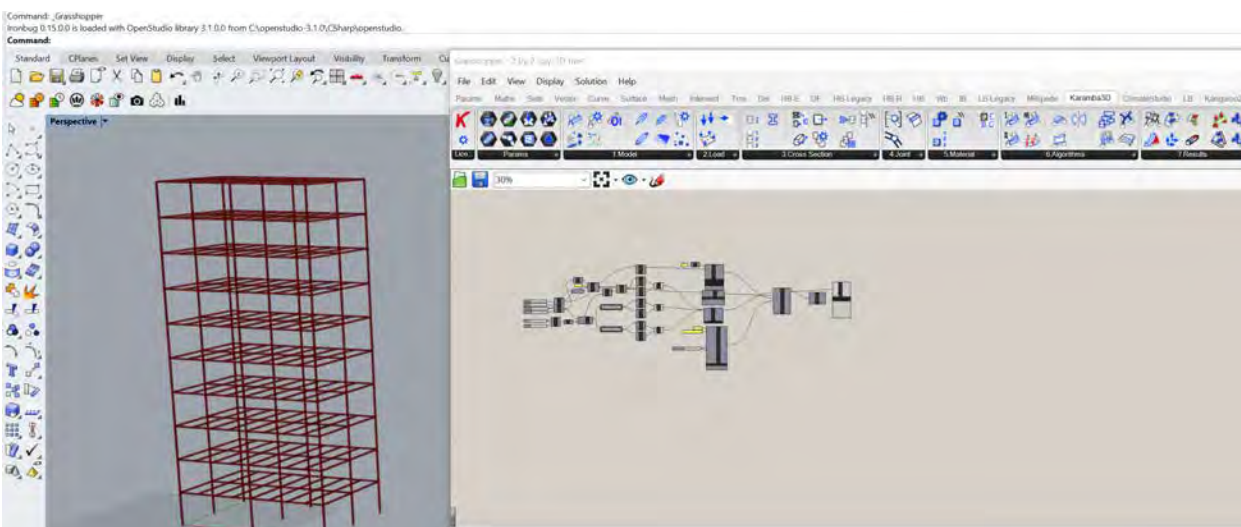

Figure 2: A structural model using 3D and 4D data structures.

Proposed solution for Challenge 1: *automatic generation of structural model using building shell, reference levels, and column grids*

Massing studies one of the most important processes in the early schematic design phase. Students explore various massing schemes based on site context, program requirements, etc. As massing studies further develop, students

need to interactively find a suitable structural system for their evolving designs. In this research, we propose a method that can automatically generate structural members when students have the shell of the buildings designed. Two other input parameters are needed for this automatic generation process, namely, the vertical reference levels and the horizontal column grid. Given all three inputs, the structural members are generated based on the following steps.

Step 1: The building shell (shown in Figure 3a as an example) is sliced to generate outlines of each floor at each level (Figure 3c). Figure 3b (front elevation) shows that the lines are generated along the Z axis based on a Ground Level (16 ft) and Typical Floor Level (12 ft). In Grasshopper, slicing can be done by projecting a line at each level onto the building shell geometry horizontally.

Step 2: Column grid-based spans are generated along two different axes as shown in Figure 3d (The two axes are usually perpendicular but may be at any angle greater than zero and less than 180 degrees).

Step 3: The column grid is projected onto the outlines of each floor to generate grid points on each floor as shown in Figure 3e. Any grid points that are outside of the outlines are removed from the grid.

Step 4: Columns are generated by connecting the grid points between contiguous floors, and beams are generated along two different axes by connecting the grid points on the same floor as shown in Figure 3f.

With this automated generation method, students can easily generate structural members for their design in seconds with only three inputs, building shell, levels, and column grids. Figure 3g shows the simulation results from Karamba using the beams and columns generated by the automatic system. Figure 3h shows the Grasshopper definition for of the automated generation system. The green region in the definition shows inputs, namely, the building shell as a B-rep, the reference levels as a list of numbers, and the column spans along two different axes. The purple region in the definition shows the custom function developed in this study, *Gen_Structure*, which generates the columns and beams. The cyan region in the definition shows the typical Karamba workflow with the default material and cross section.

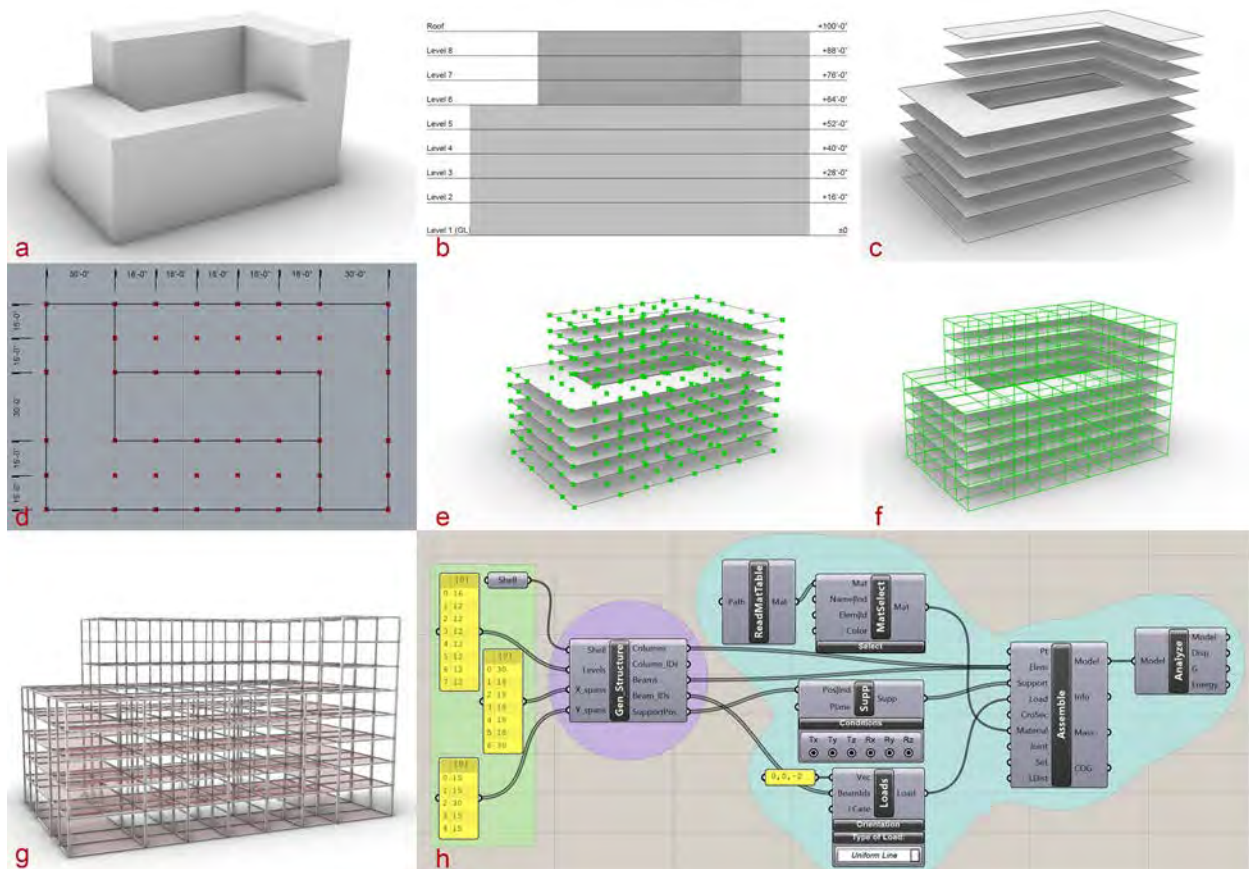

Figure 3: Process explaining how a structural model is automatically generated.

2.2. Challenge 2: Karamba does not size beams based on individual deflection as a ratio of span

Deflection and stiffness are some of the most important factors in determining the size of a beam. The maximum allowable deflection of a beam is typically specified in building codes and is determined as a fraction of the span (ICC), i.e. building codes set a maximum value for the term D/L , Deflection D divided by the span (Length) of the beam L . There are two functions in Karamba that can be used for sizing a beam, but neither is optimal for sizing cross sections.

The first, *Optimize Cross Section*, takes the maximum allowable deflection as one of its input values and sizes all members based on that same criterion. Since members with different spans have different allowable maximum deflections, this optimizer can either oversize longer members or make shorter members non-compliant with building codes. For example, if a building code limits the maximum allowable deflection to $L/240$, then a 20-foot beam is allowed to deflect up to 1" while a 30-foot beam is allowed to deflect up to 1.5". If we set 1" as the input to the optimizer, Karamba sizes all beams based on 1" maximum deflection, which means that the 30-foot beams will be oversized. On the other hand, if we set 1.5" as the input to the optimizer, Karamba undersizes 20-foot beams allowing the beams to deflect up to 1.5", which would not satisfy the $L/240$ code requirement. Another challenge of this optimizer is that it may size all beams differently based on the load conditions even if the beams might have the same spans. This can present great challenges for construction management in terms of material supply and on-site assembly. Figure 4 shows the optimization results by the *Optimize Cross Section*, and we can see that almost all members are sized differently.

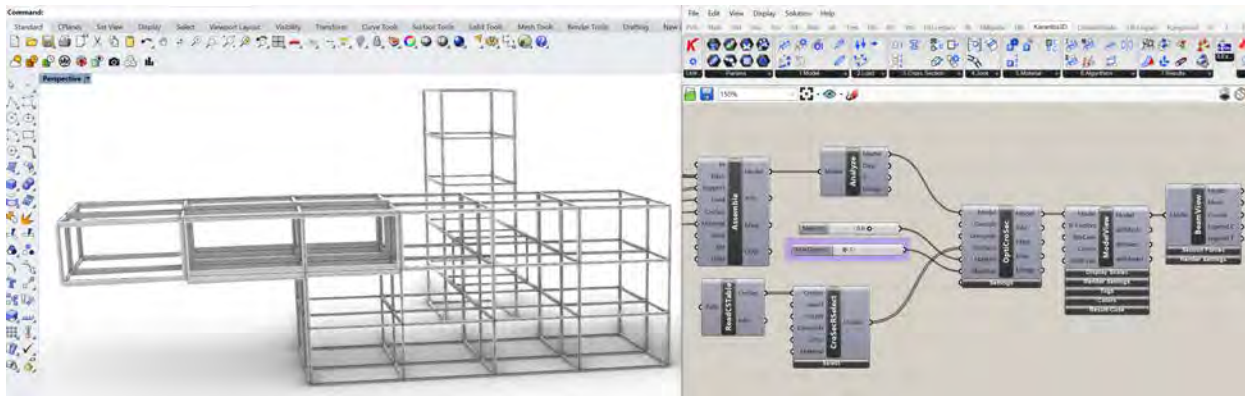

Figure 4: The optimization function in Karamba sizes all structural members with one single max displacement.

The second function, that can be used to analyze structural members, is *Beam Displacements* which analyzes the deflection of all beams of a structural model based on a single cross section given by the user. The analyzer provides deflection at any point along the beam. The user has the option to run a simulation with one cross section at a time or testing multiple cross sections at the same time. Manually running one cross section at a time is extremely tedious and labor-intensive since there could potentially be hundreds of cross sections to run manually. A user has the option to feed the multiple cross sections to Karamba and filter out the best fitting cross section from the field of input values. The challenge in feeding multiple cross sections is that Karamba will run multiple models which consumes more computer memory and takes longer to run. Theoretically, a user should be able to feed the entire library of cross sections to Karamba and filter out the best fitting cross section from the analysis results. Currently there are more than 17,000 cross sections in the Karamba default library. Feeding the entire library and simultaneously running 17,000+ models would take a powerful computer several hours to respond, that is if it does not crash trying. Even if a user limits the cross section parameter to a specific family of cross sections, for example, steel wide flange beams used in the USA, the simulation would take several minutes to produce results, even on a powerful desktop computer. Changing a slider value could cause the software to freeze for several minutes before being responsive again. As a result, passing the entire library of cross sections to the *Beam Displacement* function to find the best fitting cross section quickly becomes impractical.

Proposed solution for challenge 2: an automated iterative sizing framework

Since running the entire library of cross-sectional profiles at the same time will freeze up the computer and running one cross section at a time is extremely labor-intensive, one of the logical approaches is to automatically iterate through the library and simulate one cross section at a time. This way, a user only needs to initiate the simulation one time and the computer will finish the iteration. At the end of the simulation, the software will be very responsive since it contains only one model instead of hundreds of models if not more. There are three options in Grasshopper to handle iteration: *Animate* (a Grasshopper native function), looping plug-ins such as *HoopSnake* or *Anemone*, or a custom script with Python or C#. Despite its slightly longer run time, we chose to use the *Animate* function in this study because students find it more user-friendly.

We also compared three algorithms, namely, brute force, pruning, and genetic algorithm/ simulated annealing. The brute force algorithm runs the simulations by iterating through every cross section in the library. On the other hand, pruning eliminates obvious options to reduce the number of simulations. For example, if a W8x21 beam is not big enough and deflects excessively, the algorithm will eliminate all cross sections that have less moment of inertia since they will not provide enough stiffness either. If a W12x21 satisfies the deflection requirements, all cross sections with greater moment of inertia and cross-sectional area will also be excluded since they will not be optimal. With the pruning

algorithm, the simulation time can be reduced dramatically. Although Grasshopper incorporated the genetic algorithm and simulated annealing with *Galapagos*, these two algorithms are not optimal for solving this problem. These two algorithms work well for non-convex functions with multiple local optima. Since deflection decreases monotonically as the moment of inertia of a cross section increases, beam sizing is clearly a convex problem. Using genetic algorithms or simulated annealing to solve convex problems may lead to a suboptimal solution with longer simulation time.

2.3. Challenge 3: Visualization

Karamba generates solid geometries of the beams and columns after the simulation is complete. These beams and columns can be directly baked into Rhino to show the structure. However, the beams are not flush at the top if their sizes are different, because Karamba aligns the beams by the centerlines of their cross sections (Figure 5). Although students can manually align the beams and this task is not considered labor-intensive, it is just another avoidable step for students to accurately visualize structural models.

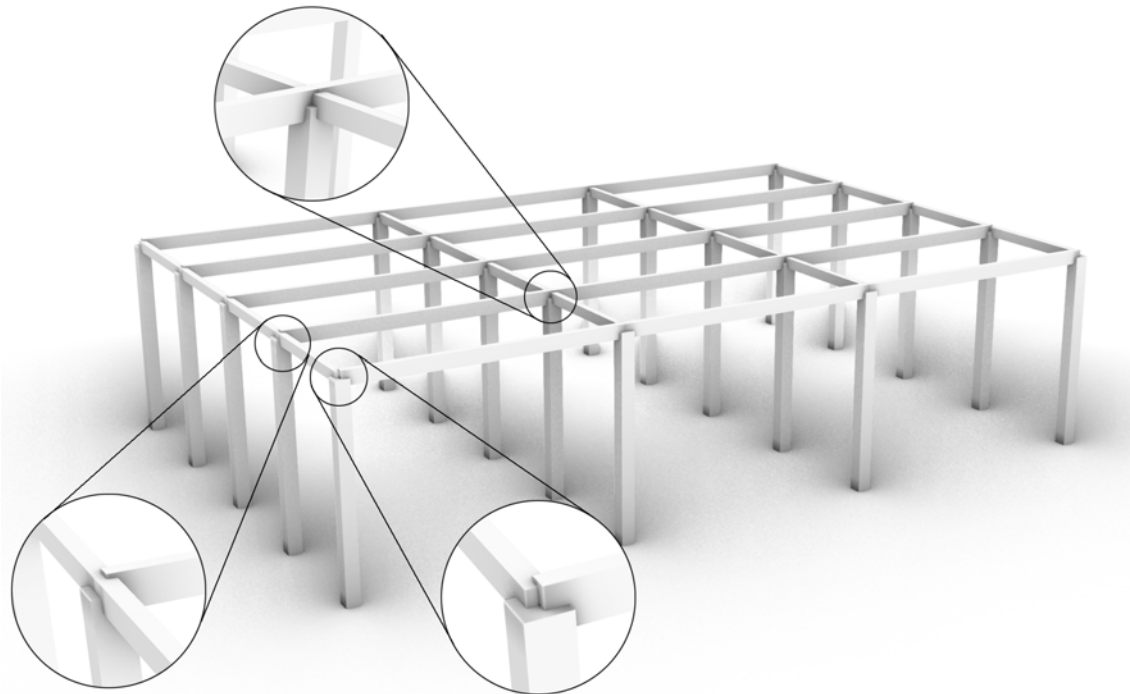

Figure 5: The structural members generated by Karamba are not flush on the top.

Proposed solution for challenge 3: *A visualization module for the simulation results*

We developed a visualization module that can top-align all beams and generate correct geometries. For example, Figure 6 shows the alignment and the shapes of the glulam columns and beams when 'castle joint' is selected. The Beams are all top-aligned despite their difference in size, and the columns are shaped differently based on their location; Center, Edge, or Corner. Automatically generating visualization models will help students save time on manually editing geometries of the columns and beams in Rhino.

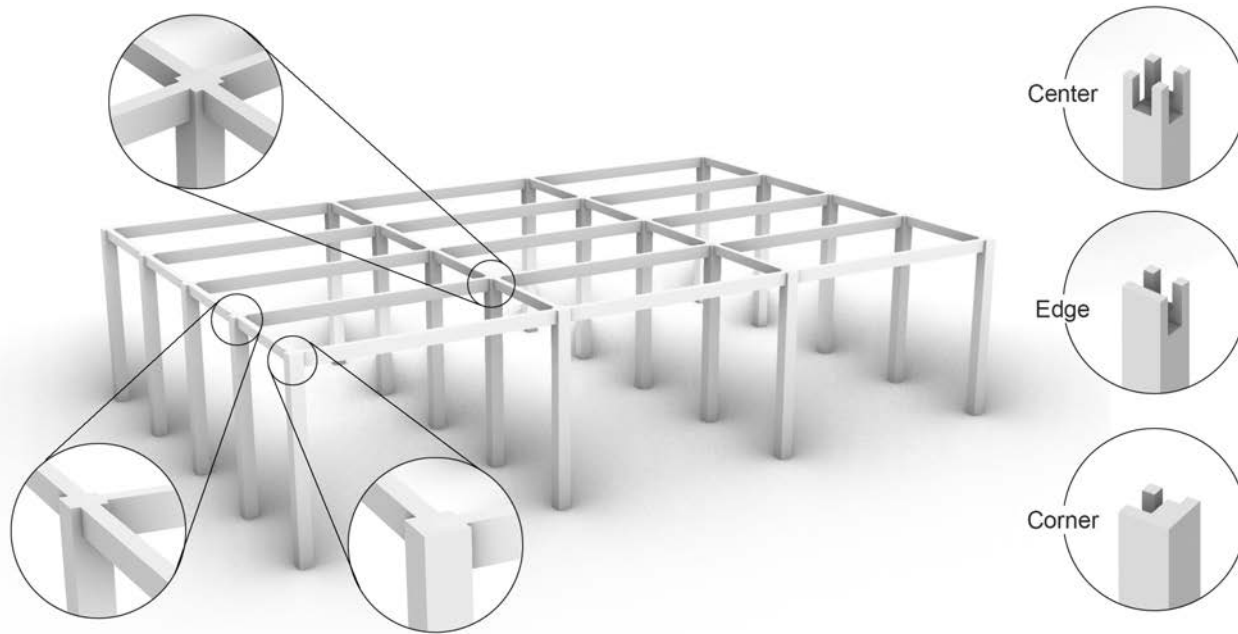

Figure 6: The structural model generated by the visualization module. Beams are top-aligned and the geometries of the columns are generated based on their locations.

3.0 PILOT STUDY

The methods proposed in this study have been successfully tested on small to medium size buildings as shown in the examples in section 2 of this paper. To test the scalability, we modeled a large building to investigate how well the methods apply. Figure 7 shows the model of Amorepacific office building in Seoul designed by David Chipperfield. The total area of the building is over two million square feet. The automatic generation system has successfully generated 2416 columns and 4536 beams within a few seconds.

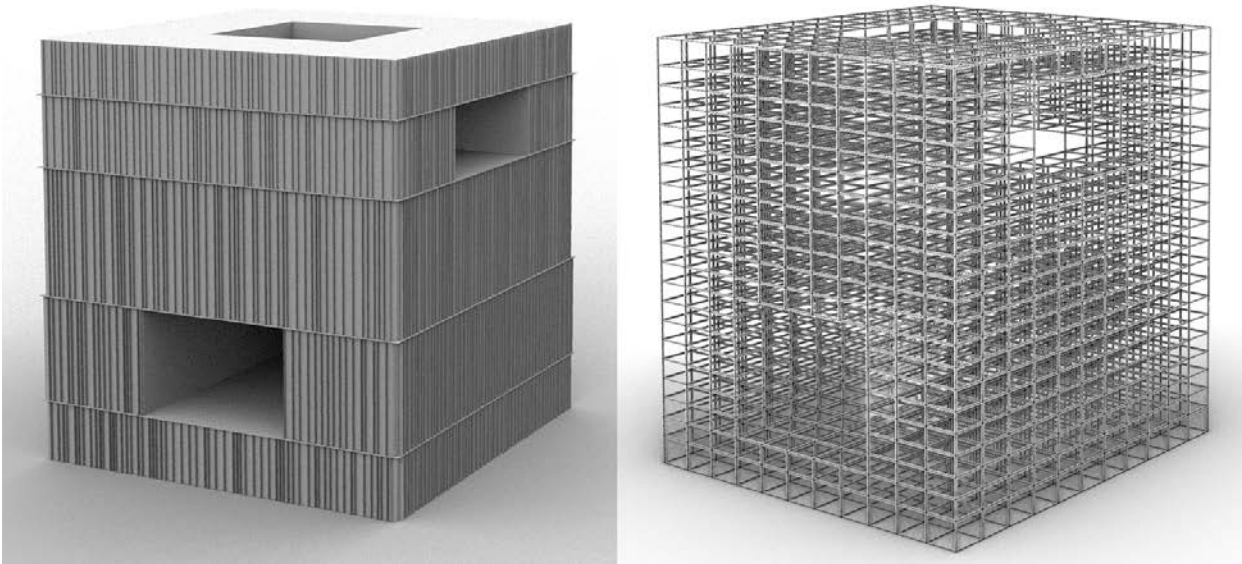

Figure 7: Automatically generated structural model of Amorepacific building designed by David Chipperfield.

CONCLUSION

Karamba is built on the Rhino/Grasshopper platform, one of the most popular modeling platforms used by architecture students in the design studio. The familiarity of the user interface allows architecture students to more easily learn the software and potentially integrate structural analysis seamlessly in their studio projects. Nonetheless, students rarely use Karamba or any other simulation software for structural analysis of their studio designs. In this study, we identified three major challenges that impede students from integrating structural analysis into their studio projects using Karamba. We explored three solutions to overcome the challenges. With a pilot test, we demonstrated that these three solutions greatly facilitate the process for running structural simulation of a studio project. The three challenges that we identified in Karamba are not intrinsic limitations, but rather missing features that can be addressed through future software development. Until then, the proposed methods in this study can serve as a gateway for students to integrate structural analysis into their design studio projects. Future study may include the investigation of other structural systems such bearing walls, domes, etc., expanding from the column and beam trabeated system that was the focus of this study. A limitation of the system is that it only can be applied to a grid structural system, i.e., it is not suitable for irregular structural layout or organic forms. In addition, the robustness of the methods can be tested with more studio projects and further improve upon trials and errors.

REFERENCES

- Agenda. Digital Structures. (n.d.). Retrieved November 13, 2021, from <http://digitalstructures.mit.edu/page/research#agenda>.
- Allen, Edward, and Joseph Iano. *The architect's studio companion: rules of thumb for preliminary design*. John Wiley & Sons, 2017.
- Hughes, Robert. *Rome: A Cultural, Visual, and Personal History*. Vintage Books, 2012.
- ICC. (n.d.). 2021 International Building Code (IBC): ICC Digital Codes. 2021 INTERNATIONAL BUILDING CODE (IBC) | ICC DIGITAL CODES. Retrieved November 13, 2021, from <https://codes.iccsafe.org/content/IBC2021P1/chapter-16-structural-design>.
- Karamba3D. "Karamba3D – parametric engineering". Accessed November 13, 2021. <https://www.karamba3d.com/>
- Magyar, Peter. History of architectural engineering. *Global Journal of Engineering and Architecture*. 2021. Volume 2, Issue 1.
- Parry, Richard, "Episteme and Techne", *The Stanford Encyclopedia of Philosophy* (Winter 2021 Edition), Edward N. Zalta (ed.), <<https://plato.stanford.edu/archives/win2021/entries/episteme-techne/>>.

ENDNOTES

- ¹ The versions of Karamba used in this study are the official release of V1.3 and the work-in-progress version of V2.0.

Design Principles for Museum Daylight Systems Based on Nine Built Examples from Renzo Piano Building Workshop

Edgar Stach¹, Michael Esposito²

¹Thomas Jefferson University, Philadelphia, PA

¹Elementa Engineering, New York, NY

ABSTRACT: This research unlocks the relationship between space, structure and light in nine unique museums developed by architect Renzo Piano. Renzo Piano uses innovative and subtle solutions for modulating natural light through a highly complex set of construction layers in the roof and ceiling. Using a comparative and standardized approach, this research analyzes the daylighting systems of these museums using the daylight simulation engine Radiance and various computer applications and plugins including Rhinoceros 3D, DIVA, and Grasshopper. The results of the analysis retrace the development of daylight systems at the RPBW museums and describe the evolution from static to dynamic to adaptive daylight systems. For the comparative analysis of the daylight conditions, the daylight systems were systematized and categorized. In a first analysis step, the museums were examined in their site-specific location and the interior design were examined using computational daylight simulation tools (Rhino, DIVA Grasshopper). In a second analysis step, the light-guiding systems were digitally analyzed by means of a standardized reference space (box) with the same parameters (room dimension, geographical position, orientation, hours of sunshine). Finally, by conducting a field analysis, the standardized computer model was benchmark and calibrated based on empirical daylight measurements from two museum projects (Menil Collection, Houston) to ensure (verify) the accuracy of the comparative analysis. The aim of this research is to serve as a guide on the applicability of system solutions of daylight control in museums - in terms of the illuminance of daylight, the room aesthetics (light contrast), object perception, and geographic location. The results of the comparative analysis using a standardized reference space (Box) allow a precise quantitative comparison of daylight systems. The final evaluation of the system solutions provides a new planning resource for architects and planners who design daylight systems and daylighting.

KEYWORDS: Computational daylight simulation, daylight control systems, DIVA and Grasshopper, adaptive daylight systems, standardized reference space

INTRODUCTION

The quality of light and the intensity (lighting conditions) in museums are the most important factors influencing the effect of the exhibition. In addition, good general lighting of the exhibition rooms is important for the spatial orientation of the visitors within the museum building and the spatial atmosphere. Particular attention must be paid to the materiality and type of the exhibitions in daylight and artificial lighting planning in exhibition rooms. Different art objects, such as paintings, sculptures or video installations, require different lighting conditions.

Examples of annual maximum number of lux/hours of exposure¹ are:

50,000 lux/hours for highly sensitive materials (50-lux)

480,000 lux/hours for moderately sensitive materials (200-lux)

The ability to perceive the exhibition by simultaneous light protection of the artwork represent a conflict of objectives in the exhibition planning. A strong exposure to light can cause aging, discoloration and other damage to the exhibition objects. As a rule, limits are therefore set for the maximum illuminance² and maximum exposure time (duration of exhibition) for photosensitive exhibits.

Through new light simulation programs, the planner has been able to make accurate statements on light intensity, accumulated light quantity, light contrast and possible glare phenomena in an early design phase. A light simulation was only possible in the past through models and mock-ups. Faulty lighting design repeatedly led to limitations in the exhibition concept or to subsequent redesigns and conversions to meet conservation and visitor requirements.

The uniform illumination of daylight is one of the main criteria in the architectural planning of museum buildings for Renzo Piano Building Workshop (RPBW). The aim of the research is to systematize, comparatively analyze and evaluate the design principles of daylight systems and daylighting in RPBW museum projects. For this purpose, 9

selected museums developed by RPBW between 1986 and 2008 were analyzed and the connection between the spatial concept, the design principle of the light control system and the daylight quality (qualitative and quantitative computer analysis) documented.

In a first analysis step, the museums were examined in their site-specific location and the interior design were examined by daylight simulation technology using computer analysis (Rhino 5 DIVA Grasshopper script). In a second analysis step, the light-guiding systems were digitally analyzed by means of a standardized reference space (box) with the same parameters (room dimension, geographical position, orientation, hours of sunshine). Finally, by conducting a field analysis, the computer model was benchmarked and calibrated.

The categorization and analytical evaluation of the applied light control systems provides exhibition and museum planners and architects with planning assistance in the early design phase. Graphical analysis and daylight simulation will provide a new approach to the Renzo Piano Building Workshop architectural work. The abstracted form of comparative computer analysis by means of a standardized reference space (box analysis) clearly illustrates the correlation between the light-guiding system, the construction and the perception. The simulation of natural lighting provides more planning security and enables more coherent and more economical lighting concepts. In addition, the possible uses of different daylight system solutions in different geographic locations are presented. The aim is to achieve planning reliability in the field of daylight control at an early stage of the design process.

1.0 APPROACH AND METHODOLOGY

1.1 Research Matrix

The research matrix shows the two research methods used in the comparative analysis: [Fig. 1]

1. Typological order of daylighting systems
2. Computational analysis of systems

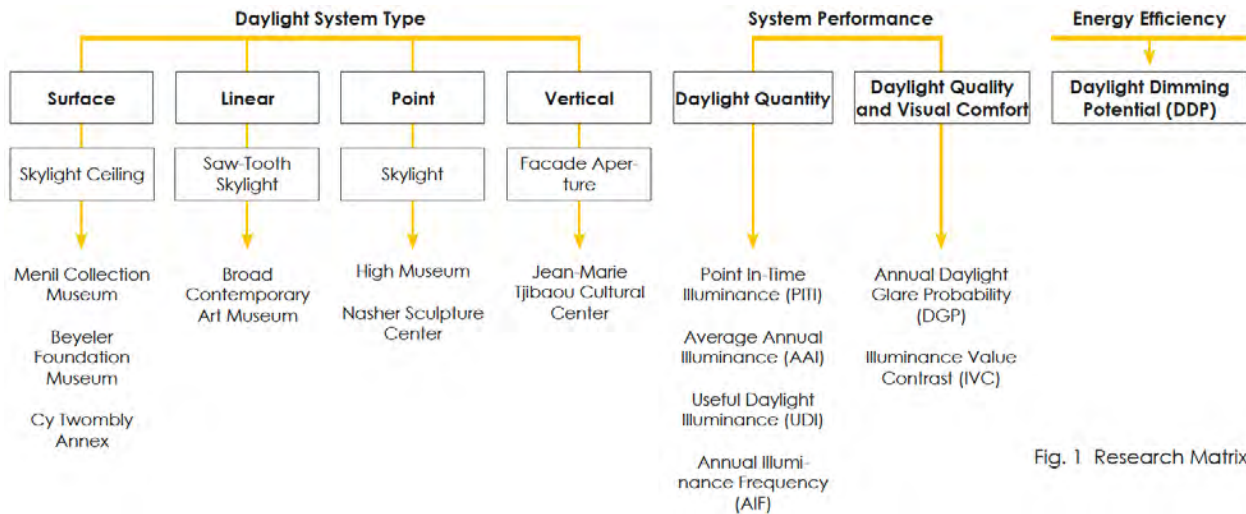

Fig. 1 Research Matrix

1.2. Daylighting systems typologies

Modern museums design requires daylight art galleries with diffuse daylight for comfortable viewing and acceptable low rate of damage. In principle, daylighting systems can be categorized by the geometry of the light ceiling. In surface systems, the entire ceiling of the gallery is glass; in linear systems, the linear skylight is either horizontal (roof glazing strip) or vertical (saw-tooth); or in point systems, the daylight system consists of individual skylights. In vertical systems, the light enters the gallery through vertical openings (single window or glass facades). [Fig.2]

Daylight-diffusing skylights such as glass roofs, linear horizontal skylights, and point skylights receive the sum of direct sunlight, blue-sky light, and cloud-reflected light and modulate the light through translucent materials and louvers. Polar oriented skylights (saw-tooth skylight) use the northern orientation and external shading to avoid direct sunlight entering the gallery space. The advantage is that the source of the light is less variable throughout the day in comparison to direct sunlight. Because the sheds diffuse the sunlight, clear glazing can be used to allow the occupant to observe the sky condition.

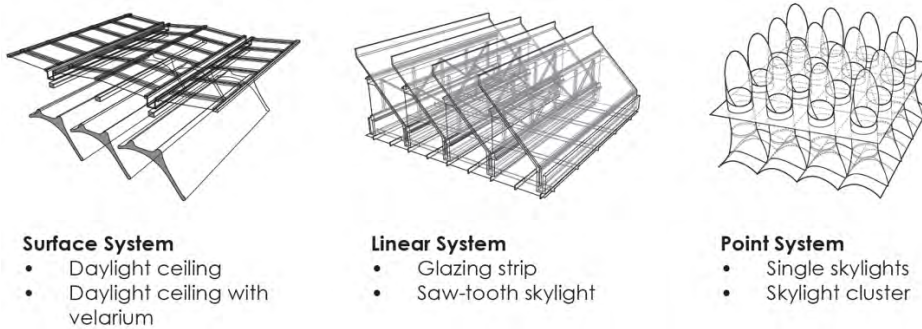

Fig. 2: Daylighting systems typologies

Side-lit galleries (vertical systems) are good for displaying three-dimensional artwork like sculptures and reliefs; the lateral light flow reveals superbly the form and texture. Side-lit galleries can be problematic for picture galleries; a picture facing a window causes the image of the window to reflect upon the picture. Pictures need to be tilted forward to avoid the veiling reflection.

1.3 Comparative Analysis of Natural Lighting Scheme

Fig. 5 Shows the all eight analysed RPBW projects and their daylighting system. Important by the following DIVA-daylighting analysis was to differentiate passive and active shading system in terms of their ability to dynamically adjust the daylight shading. [Fig. 3]

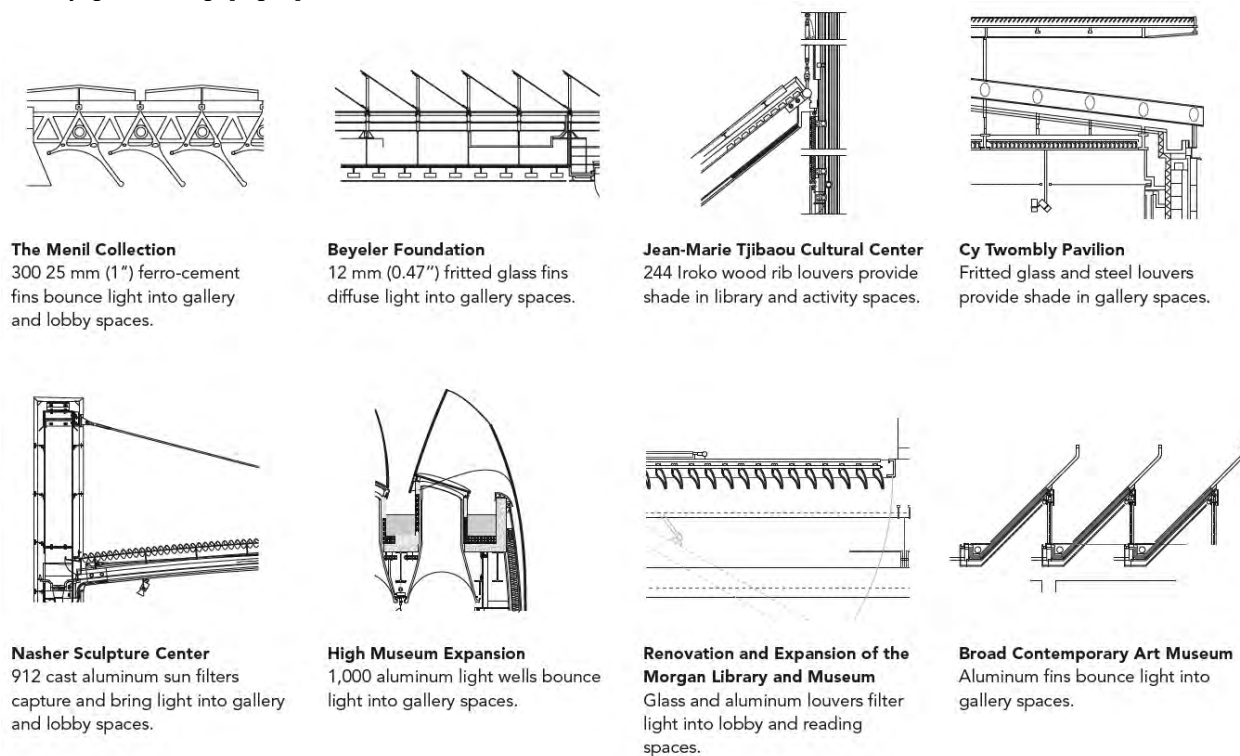

Fig. 3: Passive shading system: The Menil Collection, J-M Tjibaou Culture Center, Nasher Sculpture Center High Museum. Active shading system: Beyeler Foundation, Cy Twombly Pavilion, Morgan Library, Broad Contemporary Art Museum.

1.3. Daylight Analysis with DIVA for Rhino

For the daylight analysis, the program DIVA was selected. DIVA-for-Rhino is a highly optimized daylighting and energy modeling plug-in for the program Rhinoceros. DIVA-for-Rhino can be used to carry out a series of environmental performance evaluations of individual museums and galleries in one model: Climate-Based Daylighting Metrics, Annual and Individual Time Step Glare Analysis, and Load Calculations. DIVA uses Radiance and Daysim for its calculation engines.

The Climate-Based Daylighting Metrics [Fig. 4] use recorded climate data from the entire year to simulate the sun and sky conditions at specific times (Point-In-Time Illuminance) and annually (Average Annual Illuminance). DIVA simulates

the visual comfort (point-in-time glare) of a person under the simulated conditions and evaluates the visual comfort (Daylight Glare Probability) by simulating the overall brightness of the view, position of 'glare' sources, and visual contrast. The electric load calculations (Daylighting Dimming Potential) predict the annual energy consumption for electric lighting of a gallery space.

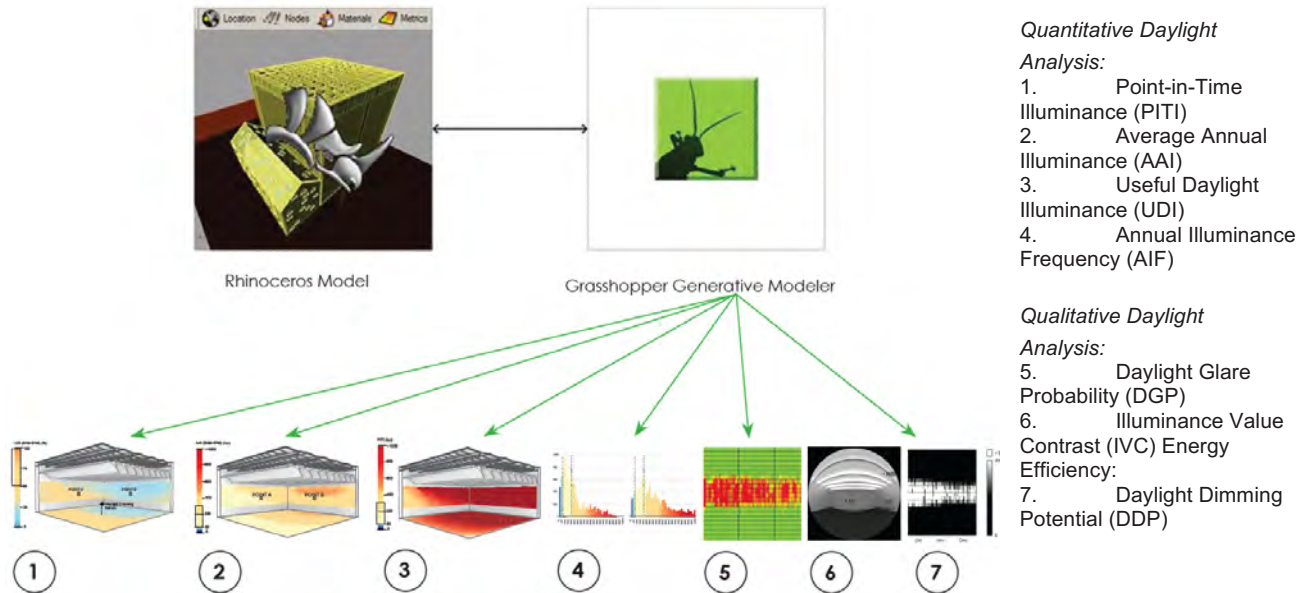

Fig. 4: Daylight Matrix

Input Parameter for Grasshopper -DIVA

For an accurate computer simulation, it is necessary to describe as accurately as possible the daylight parameters of the geographic location, materiality, surface texture, and light guidance system, and to define them as inputs in DIVA. [Fig. 5]

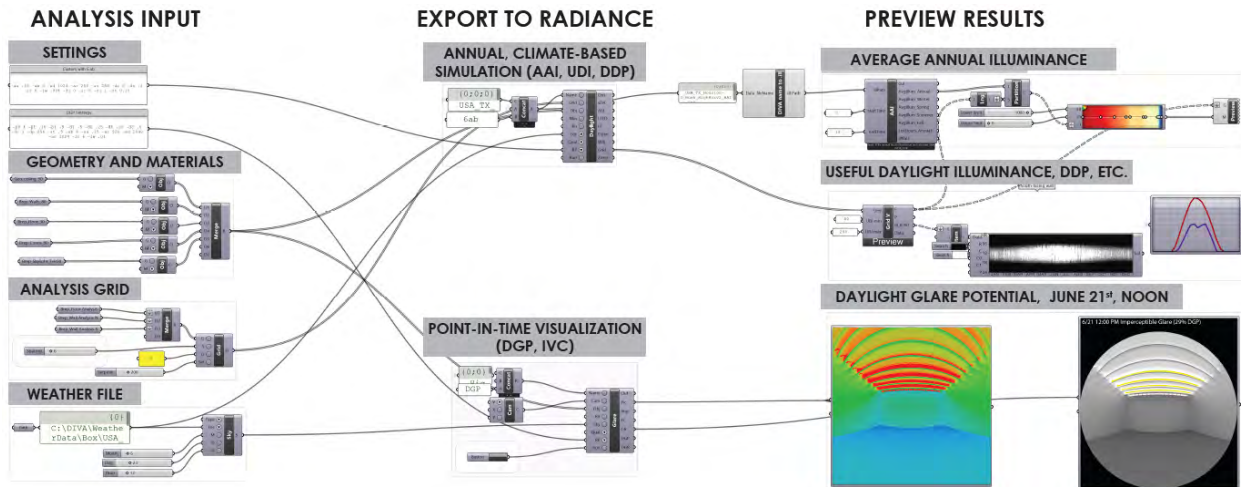

Fig. 5: Screenshot of the Parametric Logic of the Grasshopper Script

2.0 RPBW MUSEUM PROJECTS BUILT BETWEEN 1982 AND 2008

2.1. Computer analysis of individual museum projects

The daylight analysis of all RPBW museums follows a standard format and includes a suite of technical images [Fig. 7], graphs, and an explanation to holistically describe the daylight condition. The Quantitative and Qualitative Daylight Analysis were based on the Daylight Matrix [Fig. 4]. An evaluation summary [Fig. 6] for each museum was the base for the comparative analysis. The Daylight Dimming Potential (DDP) was calculated. [Fig. 9]

Location
Climate: Temperate
Building orientation: North/northeast
Louver orientation: South/southwest
Material Properties
Walls and surface finishes
Wall: SW 7757 High Reflective White, LRV 92.6%
Floor: Natural oak, LRV 37.9%
Exposed structure: White paint, LRV 80%
Overhead Skylight Glass
Skylight glass: VLT 50%, double pane low-e glass wjth UV coating
Reflection: Specular
Light-Guiding System – Control Logic
External shading: Static system, fixed 12 mm (0.47") tempered glass panels, white ceramic frit screen-printed 50% coverage, ¹ diffusing, VLT 40%
Internal shading: Kinetic system; computer-motorized aluminum louver blades
Location of louvers: Under skylight, white paint, LRV 80%
Glass ceiling: Laminated glass, clear, VLT 90%
"Velum" suspended ceiling grid: Perforated metal panels incorporating a light softening paper, diffusing, VLT 50%

Quantitative Daylight Analysis
Point-in-Time and Annual Illuminance

Point-in-Time Illuminance (PIT)	
PITI June 21, noon (South-facing wall)	272 lux
PITI June 21, noon (Center of gallery)	396 lux
Average Annual Illuminance (AAI)	
Average daylight level (South-facing wall)	160 lux
Accumulated lux-hrs annually	469,200
Recommended total exposure target (480,000 lux-hrs annually)	Below
Useful Daylight Illuminance (UDI)	
Percentage daytime hours with daylight levels of 50–200 lux (South-facing wall)	73%
Daylight Dimming Potential (DDP)	
Percentage of daytime hours with daylight levels above 200 lux (Center of gallery, 8 a.m. to 6 p.m.)	64%

Fig. 6: Example: Evaluation summary; Beyeler Foundation: Quantitative Daylight Analysis

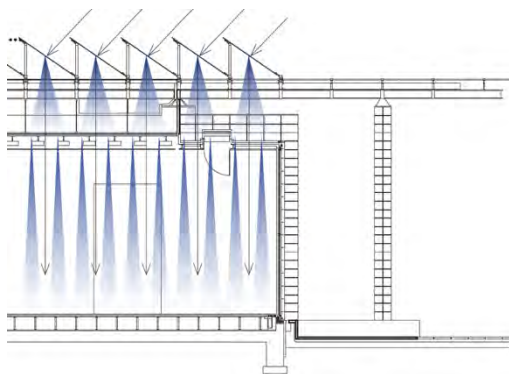

Fig. 7: Section Daylighting System; Beyeler Foundation
Multilayer linear roof composition consisting of external translucent sawtooth glass louvers facing north, a horizontal double-glazed roof, interior horizontal aluminum louvers, a translucent laminated glass ceiling and a perforated metal and paper ceiling screen. Aperture to Floor Area Ratio (AFR) is 100%.

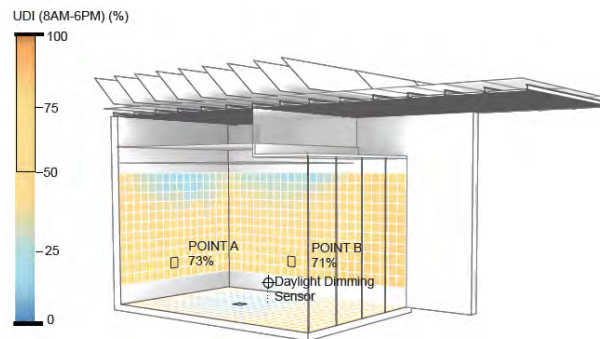

Fig. 8: Quantitative Daylight Analysis; Beyeler Foundation
Annual Illuminance Frequency and Useful Daylight Illuminance

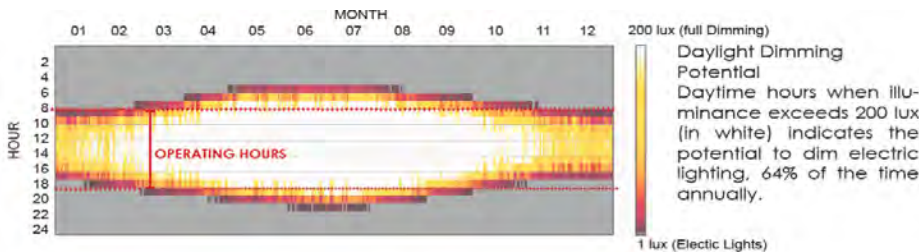

Fig. 9: Energy Efficiency; Daylight Dimming Potential; Beyeler Foundation
The matrix shows the percentage of time when the illuminance exceeds 200 lux (in white) within the operating hours of 8:00 AM to 6:00 PM, 6 days/week. The calculation takes the gradual increase of e-lighting under consideration. Calculated was 100% e-lighting below 50 lux daylight and 50% e-lighting below 200 lux daylight. Recommended Targets:

2.2. Comparative Analysis of Natural Lighting Scheme

The Quantitative daylight Analysis of the eight different daylighting systems showed a wide variation in illuminance levels and fluctuation. (Point-in-Time Illuminance (PIT) and Average Annual Illuminance (AAI), the Useful Daylight Illuminance (UDI)). The graph below shows from four different museums the Useful Daylight Illuminance (UDI). The Quantitative and Qualitative Daylight analysis showed in comparison that the Beyeler Foundation (active shading system) and the High Museum (passive shading system) performed best. [Fig. 10]

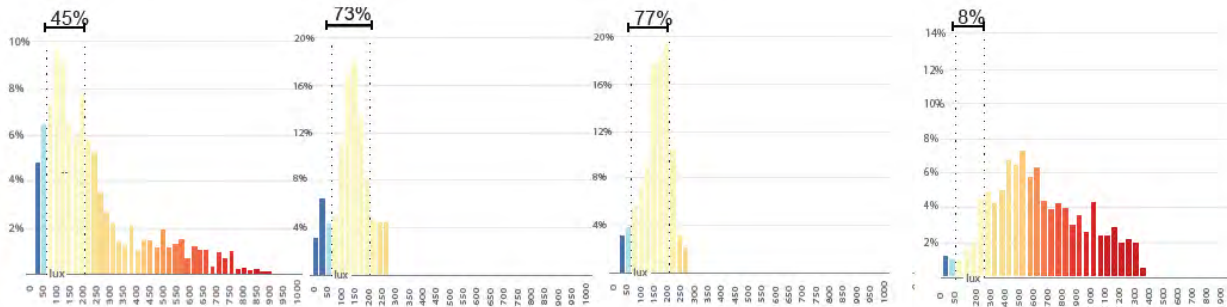

Fig. 10: (Left to right: Menil Collection, Beyeler Foundation, High Museum, Nasher Sculpture center) Annual Illuminance Frequency (South-facing wall) shows the percentage values of the occupied time in which the illuminance is within the target range (50-200 lux) annually. The graph shows the results in three bins - blue: below 50 lux - underlit; green 50-200 lux – in range; red: above 200 lux - overlit. Daylight illuminances in the range 50 to 200 lux are considered effective either as the sole source of illumination or in conjunction with artificial lighting.

The Qualitative Daylight Analysis showed significant differences in the Physiological Glare (Annual Daylight Glare Probability (DGP)) and Psychological Glare (Illuminance Value Contrast (IVC)). The Broad Contemporary Art Museum, Annual DGP [Fig. 11] simulation shows periodic direct or indirect glare on walls and floor. Point-in-time glare analysis [Fig. 12] shows luminance ratios for a gallery space with contrast values between 1:3 and 1:4. For a short period in the morning, values above 1:10 were detected.

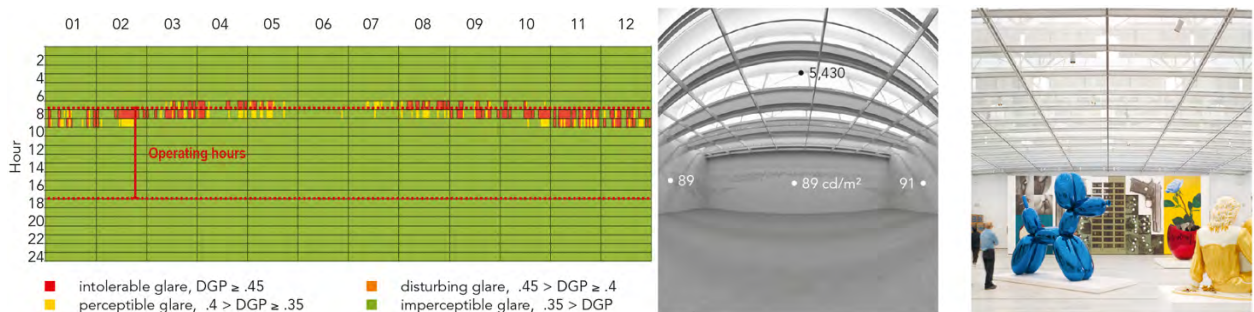

Fig. 11: Annual Daylight Glare Probability (DGP). DGP analysis indicates perceptible and disturbing glare between 7 and 9 a.m. throughout the year. Glare may be attributed to direct sunlight on the north-facing skylight aperture during the early morning hours (35–45% DGP).

Fig. 12: Illuminance Value Contrast (IVC). The rendering shows highest contrast ratios when looking north on June 21 at noon.

Fig. 13: Gallery View. View inside the upper floor gallery space.

3.0 DAYLIGHT SIMULATION AND DAYLIGHT ANALYSIS USING A STANDARDIZED REFERENCE ROOM (BOX)

3.1 Comparative Computer Analysis at the Locations *Toronto, Washington, and Houston*

In a second analytical step, the daylighting systems were comparatively analyzed by means of a standardized reference space (box) with DIVA. In order to be able to compare the various daylight systems with each other, the categorized system solutions (chapter 1.2 and 1.3) were analyzed using a standardized experimental setup. For this reason, the daylight systems were evaluated using the DIVA light simulation program in a standardized test room (box) measuring 10 x 10 meters, 5 meters high (30/30/15 feet) [Fig. 15-17]. In the box analysis, only the horizontal daylight steering over the gallery is considered, side windows did not factor into the evaluation. [Fig. 14] For all projects the same parameters of comparison including geographical orientation, surface reflection of materials and glass properties were used. The cities Toronto, Washington, and Houston are located between the latitudes 29.70 and 43.40. These locations represent a wide range of climate zones on the northern and southern hemispheres and, therefore, were chosen for the comparative computer analysis.

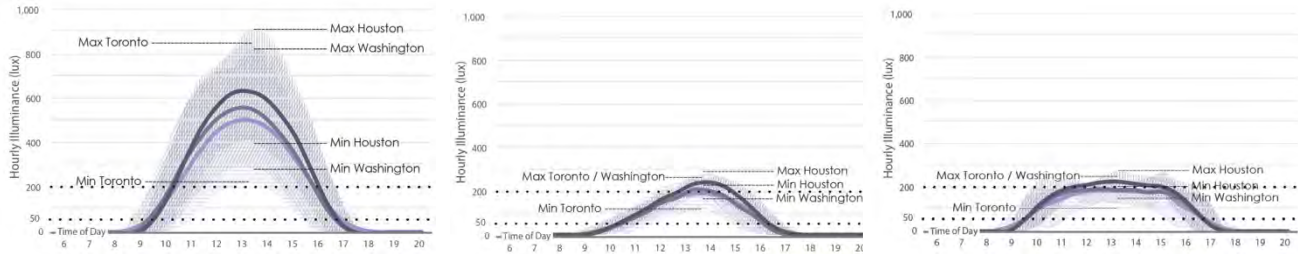

Fig. 14: Average Annual Illuminance (AAI)
The AAI plot shows the function of time and day in lux on the north-facing wall. The max. and min. illuminance values are shown for June 21st and Dec. 21st.

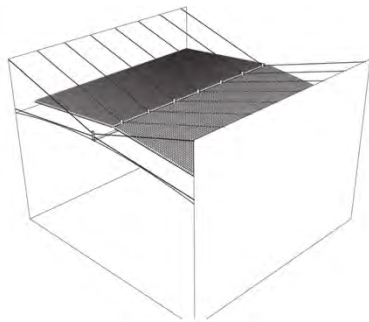

Fig. 15: Nasher Sculpture Center
Very high Illuminance Values and Glare probability

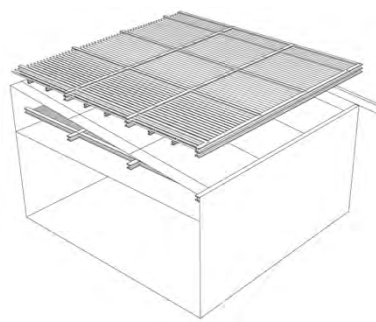

Fig. 16: The Cy Twombly Annex
Ideal Illuminance Values and Visual Comfort

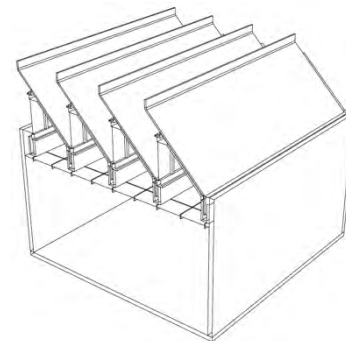

Fig. 17: The Broad Museum
Illuminance Values above the target values. Glare probability in the morning and evening hours.

3.2 Results of Graphic and Computer Analysis

The analysis shows that passive and dynamic shading systems can provide adequate daylight performance in different locations throughout the US and similar climates. The extent to which the requirements for daylight conditions are met depends greatly on the type of exhibition and the required conservation standard.

Dynamic shading systems with adjustable louvers are able to regulate the interior illuminance levels better than passive shading systems with fixed louvers. Passive shading systems show a considerably larger illuminance variation. Glass roof systems without exterior shading (The Menil Collection) are problematic in terms of solar heat gain within the gallery space below, especially in the lower latitudes. Multilayer systems with external fixed shading and internal dynamic louvers and screens (The Cy Twombly Gallery, The Morgan Library) provide balanced and controllable illuminance at all locations. The combination of exterior shading, a glass roof and a thermal buffer zone (The Beyeler Foundation) prove to be an exceptionally efficient solution for light modulation and thermal energy efficiency.

In contrast to the active systems, skylight systems (The Nasher Sculpture Center, The High Museum) regulate the illumination levels passively, resulting in more dynamic lighting scenarios. Linear sawtooth skylights (The Broad Contemporary Art Museum) offer a proven concept in many museums and galleries. However, early morning and late evening light can be problematic, especially at lower latitudes and must be addressed with vertical fins or other shading devices.

CONCLUSION

The comparative analysis of the 8 museum projects from RPBW showed the complex relationship between the shading concept and daylight control system, skylight geometry, exhibit concept, the light sensitivity of displayed art, and geographic location. The following conclusions are drawn from the analysis of *Design Principles for Museums Daylighting Systems*:

- *Passive shading* (fixed) daylight systems allow for dynamic daylight fluctuation and values; these can be considerably above the recommended maximum illuminance.
- *Active shading* (dynamic) systems control daylight fluctuation, point-in-time, and annual illuminance better but require higher building maintenance.
- *Skylight geometry*. In general, a skylight area that is approximately 15 percent³ of the floor area is sufficient to illuminate a gallery space below. Large skylights require significant shading and light filtering to dim the sunlight to the required maximum illuminance value. Polar oriented skylights allow only for northern light and exclude direct sunlight and, therefore, a practical solution.

- *Sensitivity of material.* The light sensitivity of the displayed art object defines the maximum illuminance levels and exposure time. Light sensitivity can significantly differ, for example, between sensitive watercolors and low sensitive metal sculptures.
- *Exhibit concept.* Rotating exhibits control the recommended lux exposure level by reducing the exposure time, therefore gallery illuminance level can be higher. Permanent exhibits require illuminance values within the recommended lux exposure levels all the time.
- *Location.* The angle of incoming solar radiation determines the solar energy that reaches Earth. At lower latitude (closer to the equator), the sun's rays strike Earth's surface more direct, and solar radiation is concentrated over a smaller surface area. Therefore, the museum's location is an essential factor in planning an adequate daylight control system.

From these conclusions, the following recommendation and guidelines can be made for different latitudes:

- *The design parameters.* The conservation standards of the artwork and the exhibition concept need to be defined at the beginning of the planning process.
- *Passive shading systems* can't actively control illuminance levels and fluctuation. In general, they perform better in higher latitudes with less solar radiation. For example, The Menil Collection shows an increase in point-in-time and average illuminance as well as a higher glare probability in lower latitudes.
- *Active shading systems* can provide adequate daylight in all locations and perform exceptionally well in lower latitudes. For example, The Cy Twombly Annex shows similar illuminance values in all locations.
- *Sensitive artwork.* Active shading systems provide better control over illuminance and accumulated lux exposure.
- *Medium and low sensitive artwork.* Active as well as passive system can perform adequately in all locations; also, glare can be problematic with passive systems, especially in lower latitudes due to high contrast values.
- *Surface skylights* (glass roofs) require multilayer shading to filter daylight to adequate values. Glass roof systems with only interior shading are problematic because of the solar heat gain through the glass, especially in lower latitudes.
- *Polar skylights* are a proven concept for northern light exposure and perform well in all latitudes. For example, The Broad Contemporary Art Museum shows similar illuminance values in all locations.
- *Point skylights* reduce the aperture to floor area ratio (AFR) to provide adequate illuminance values. At similar AFR, the illuminance values are increasing in lower latitudes. To control daylight values adequately, the AFR needs to be fine-tuned to the latitude.
- *Vertical systems* (glass facades, windows) provide uneven lighting conditions, veiling reflections, and high contrast values. For example, The Jean-Marie Tjibaou Culture Center shows a significant increase in illuminance values and glare probability in the lower latitudes. In general, problematic is the east-west facing facades, although the visual connection to the outdoors has a positive effect on the human's well-being.

Good daylight design in museums involves more than adherence to specified parameters for light intensity or light levels and goes far beyond purely physiological visual requirements. These guidelines are a prerequisite for good lighting, but exceptional daylight design also includes psychological, aesthetic and emotional aspects. These play a major role in the visitors' perception of light and the objects they are viewing. Aesthetic room and object lighting, the spectral composition of the light, the right lighting contrast, the necessary (adapted) light intensity, a dynamic light distribution and a natural color rendering are key for a successful lighting concept. The interaction of these aspects in relation to the perception of space, the representation of the object and the reception of the viewer is not yet fully understood. In this sense, RPBW goes far beyond fulfilling pure technical requirements. It builds spaces of experience in which the art and the object are in the foreground and the space becomes a living "art space" that supports the works of art.

REFERENCES

- Daylight in Buildings (abbreviated)
Boubekri, Mohamed, Daylighting Design: Planning Strategies and Best Practice Solutions. Birkhäuser, Basel 2014.
Brandt, Ulrike, Light Design. Edition Detail, Munich 2006.
Druzik, James, "Illuminating Alternatives: Research in Museum Lighting." Getty Institute Newsletter, 2004, 19(1).
Illuminating Engineering Society of North America, Museum and Art Gallery Lighting: A Recommended Practice, ANSI/IESNA RP-30-96, Illuminating Engineering Society of North America, New York 1996.
Köster, Helmut, Tageslichtdynamische Architektur: Grundlagen, Systeme, Projekte. Birkhäuser, Berlin 2004.
Lull, William P., and Paul N. Banks, Conservation Environment Guidelines for Libraries and Archives.
Canadian Council of Archives, Ottawa 1995.

¹ Scottish Museum Council Facts Sheet, Museums Australia Victoria, 2003

² The illuminance Lux (abbreviation: lx) is defined as the ratio of the luminous flux falling on a surface to the size of this surface. The amount of light is the product of time and emitted luminous flux is commonly referred to as lux.

³ The Manual of Museum Exhibitions, edited by Barry Lord, Gail Dexter Lord, Gail Dexter, (Alta Mira Press 2010), 169

Configurable Resiliency: Generating Sustainable Designs in Historic Neighborhoods

Mahyar Hadighi¹

¹Texas Tech University, El Paso, TX

ABSTRACT: A systematic methodology is developed for designing resilient cities focused on generating new sustainable constructions and adding to or revivifying existing buildings in historic neighborhoods. Further, an effective pedagogy for historic preservation and design is demonstrated. Developed in the literature as a computational design methodology for verifying and analyzing hybridity in architectural design, shape grammar is expanded as a foundation for analyzing the historic fabric of the urban area and creating a configurable hybrid design that is both compatible with the context and constitutive of contemporary urban resiliency. The validity of this methodology for designing configurable hybrid constructions in historic neighborhoods and its effectiveness in a historic preservation teaching focus are considered through an analysis of a series of projects and workshops, including projects from an upper-level undergraduate architectural design studio and a graduate research project. The students used the methodology to analyze historic contexts and features as a basis for generating new designs for the given context. Shape grammar methodology has been used to explore stylistic evolution in multiple ways. However, in this paper, the methodology is used to verify, describe, and generate hybridity in architectural design in general and in the historic context of a resilient city in particular. The theoretical outcomes highlight the effectiveness of shape grammar as a computational design methodology in verifying, describing, and generating hybridity in architectural design and also in the pedagogy of historic preservation and urban resiliency.

KEYWORDS: Shape grammar, historic preservation, hybridity, sustainable design, configurable architecture

INTRODUCTION

Important aspects of hybridity in architectural design, which seems to be a modern phenomenon, have already been addressed in the literature—especially the notion of hybridity between modern architecture and traditional architecture and the duality between modern and traditional, international and local, and designed and vernacular in architectural practice. Terms such as “critical regionalism,” “high-style” versus “popular” architecture in the mid-twentieth century, “Brazilian popular modernism,” and “vernacular modernism” or the contrast between vernacular traditions and the twentieth-century built environment all refer to this duality in various geographic locations or time periods (Delvin and Nasar 1989; Frampton 1983; King 2006/07; Lara 2008; Umbach and Huppauf, 2005; Upton 1986). However, the notion of hybridity between old and new or traditional and contemporary in the discipline of historic preservation has not yet been explored in depth. Questions such as how to design new construction and add to or retrofit existing buildings in historic neighborhoods are controversial in terms of the extent to which the new design or addition should match or contrast with the existing historic fabric. Such considerations deserve careful attention in the educational environment so that when students are exposed to contextual analysis they learn from the past without simply copying the specific precedents analyzed.

Hybridity between the past and the future in historic neighborhoods can only be achieved with many other essential issues taken into account, such as the qualities of the site, environmental aspects, sustainability, and code and zoning. Students can, therefore, gain a much more realistic experience of creating hybrid designs in a design studio context where the focal project encompasses at least some of these considerations. In previous research, the author has shown that shape grammar can be used as a computational methodology to identify and explain hybridity in architectural design. In the present paper, the systematic methodology developed to identify and explain hybridity in architectural design is modified and further developed in order to serve as a tool for generating sustainable designs in historic neighborhoods. The theoretical outcomes highlight the effectiveness of shape grammar as a means of identifying, explaining, and generating hybridity in architectural design, as a tool for generating designs appropriate to historic contexts with the use of sustainable strategies, and as an important element in achieving an effective pedagogy for historic preservation and design.

1.0 METHODOLOGY

The present paper extends a large-scale project in which shape grammar is used to verify, describe, and generate hybridity in architectural design. In that project, the residential work of William Hajjar, a faculty practitioner in the mid-twentieth century, featured as a case study showing hybridity between European modern architecture and American traditional architecture. This hybridity in Hajjar’s work was identified and analyzed according to the following steps: (1)

Hajjar's life and practice were followed to identify likely influences on his architectural design language. (2) A shape grammar was developed for the houses he designed and built in State College, PA, home of Penn State University, where he taught and practiced in the mid-twentieth century. (3) Grammars of some of the likely influences on his work were developed. (4) The grammar developed for Hajjar's work was compared and contrasted with the grammars developed for his likely influences in order to determine the nature and extent of their impact. (5) Aspects of the social and technological context were identified to explain such influences identified through the grammar comparison.

To test the effectiveness of the proposed methodology in generating (sustainable) designs appropriate to historical contexts especially in the pedagogy of historic preservation, the steps described were explained to students participating in an upper-level undergraduate design studio. The students were asked to (1) perform a contextual analysis; (2) study the code, zoning and aspects of sustainability; (3) demonstrate an understanding of the needs of contemporary life in terms of analyzing the architectural program; (4) develop their own rules or modify the rules previously developed for analyzing Hajjar's architectural hybridity based on the previous three steps in order to generate sustainable designs appropriate to a historic context; and (5) develop a design generated by the grammar by drawing on their architectural intuition in line with program requirements and with sustainability taken into account.

In parallel research with a graduate student at Texas Tech University, a framework is proposed to aid architects in meaningfully considering historical context and sustainability in the design of building façades in historic neighborhoods. The framework was created through four main steps: (1) Shape rules were extracted from iconic historical architecture in the historic neighborhood resulting in the creation of a descriptive grammar. (2) Shape rules were extracted from examples of successful sustainable contemporary designs in the cultural and ecological region. (3) The rules of the descriptive grammar were modified based on the rules extracted from sustainable contemporary architecture in the region. (4) Design solutions constituting the production of a prescriptive grammar were generated (Zolghadrasli & Hadighi 2021).

1.1 Shape grammar

Defined by George Stiny and James Gips in 1971, shape grammar in computation is a way to generate shapes through shape-specific rules. In other words, shape grammars are a specific class of production systems based on an initial shape or set of finite shapes and transformational shape rules (Stiny & Gips 1971). Shape grammars began as a concept, with early applications focused on fine arts (1989), decorative arts (1977), architecture (1978), and eventually design (1998), including urban design (2011). The concept of shape grammar has been used in architectural analysis when a pattern of design characteristics or a stylistic repetition of shapes in architecture is evident. This method has been used to analyze examples of historical architecture, such as Palladian Villas (Stiny & Mitchell 1978), Frank Lloyd Wright's Prairie houses (Koning & Elizenberg 1981), bungalow houses (Downing & Flemming 1981), Queen Anne houses (Flemming 1987), Alvaro Siza's houses at Malagueira (Duarte 2005), and most recently William Hajjar's single-family houses in central Pennsylvania (Hadighi & Duarte 2018).

Traditionally, the shape grammar methodology is used to describe or analyze a design, to produce a design or a series of designs, and/or to determine the design tradition to which a given design belongs. However, the shape grammar concept is also highly productive in studying and drawing on the design principles of an earlier period for the purpose of adapting them for modern purposes (Hadighi & Duarte 2019). It can also be used to redefine and extend contemporary designs, which is the defining purpose of the current paper. Dutch architect, educator, and theorist, John Habraken makes a case for adaptations of this nature as follows (Habraken 1988):

When we want to connect to our cultural tradition we must study in depth the building types this tradition maintained for many centuries. We must study them, not in the way historians would do, but from a designer's point of view. We want to understand the design principles behind the building type to decide how we can use them today. Our goal is not to copy but to transform what was done in the past into something compatible with the values we hold today. We want to learn from our cultural heritage, not to deny present day realities, but to establish a continuity between tradition and renewal.

The idea of a grammar comparison has been explored by several scholars in the past three decades in order to analyze stylistic evolution in design. For example, a comparison of this kind is essential in explaining the transformation of Frank Lloyd Wright's Prairie houses into Usonian houses (Knight 1983), analyzing contemporary houses in Turkey (Çolakoğlu 2005), establishing the notion of composite grammar (Chase & Ahmad 2005), adapting existing house types to contemporary needs (Eloy & Duarte 2011), defining Alberti's influence on Portuguese architecture (Figueiredo et al. 2014), producing a generic housing grammar (Benros 2018), and most recently contextualizing the International Style architecture in a specific locale (Hadighi & Duarte 2020). In the present paper, the methodology is expanded to design hybrid constructions in historic contexts with key real-world issues such as sustainability considered in the final design.

2.0 A GRAMMAR FOR HYBRIDITY

The practice of William Hajjar, a faculty member at Penn State University in the mid-twentieth century and a practitioner in the area is analyzed in a previous paper (Hadighi & Duarte 2018). Born into an immigrant Lebanese family in Massachusetts, Hajjar (1917–2000) studied architecture at Carnegie Mellon (1936–1940) at a time when the school's philosophy of design privileged the Beaux Arts principles. In his graduate studies at the Massachusetts Institute of Technology (MIT) (1940–1941), Hajjar learned about European modernism both through working with his supervisor,

Lawrence Anderson—who designed one of the first modern buildings on an American campus (built in 1939)—and through interacting with Walter Gropius and Marcel Breuer, who were at Harvard but through an MIT–Harvard collaboration reviewed the work of Anderson’s students at MIT. Hajjar took a faculty position at Penn State (the Pennsylvania State College at the time) in 1946. From 1952, when his first design for State College was realized, until 1963, when he moved to Philadelphia to work with Vincent King, a friend from MIT and a successful Philadelphia architect, Hajjar designed and built thirty-three single-family houses in the Penn State area in addition to other types of architecture. A key to his success as an architect of local single-family residences was his use of the shapes, rules, and principles of both European modern architecture and American traditional architecture. To identify and analyze this hybridity in Hajjar’s work, three grammars were created: a grammar for Hajjar’s single-family residential architecture in State College, PA (home of Penn State University) (Hadighi & Duarte 2018); a grammar for the work of his major influences from European modern architecture, i.e., single-family architecture designed by Gropius and Breuer (Hadighi & Duarte 2019a); and a grammar for American traditional houses of the context, i.e., the Penn State area, where Hajjar taught and practiced (Hadighi & Duarte 2019b).

The three grammars were then compared and contrasted in three different ways to identify the extent to which Hajjar’s architecture was influenced by European modernism—in this case Gropius and Breuer’s architecture—and the American traditional architecture of the context (Hadighi & Duarte 2020): (1) The rules of the three grammars were compared in order to determine which rules in Hajjar’s grammar were borrowed with or without adaptation from the other two grammars (all three grammars were developed in the same way and with the same level of detail and organized according to eleven categories, such as rules for volumetric organization and rules for dividing the interior spaces) (Figure 1). (2) A step-by-step comparison was carried out of the derivations of the designs (house plans) generated by the grammars—in this case a house generated by the grammar for Hajjar’s architecture, a house generated by the grammar for Gropius and Breuer’s architecture, and a house generated by the grammar for the American traditional architecture of the context (Figure 2). (3) Compare a house that was used to derive a grammar with a similar house generated by another grammar. For example, the American Traditional grammar was used to produce a design as close as possible to a house designed by Hajjar in order to establish in a rigorous way the extent to which houses designed by Hajjar can be generated by the grammar for Traditional houses. (Figure 3). Through a process of this kind, it is possible to understand the extent to which one kind of architecture (in this case the work produced by Hajjar) is influenced by another kind (in this case the European modern work produced by Gropius and Breuer) and by the dominant architecture of the context (in this case the American traditional architecture typifying the locale of Penn State).

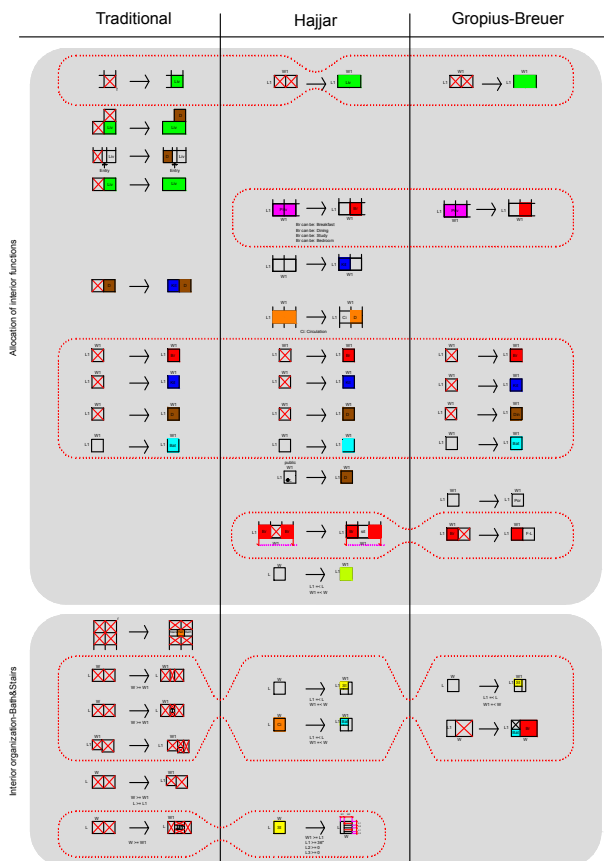

Figure 1: Comparison of the rules of the three grammars. Similar rules are highlighted with a red border.

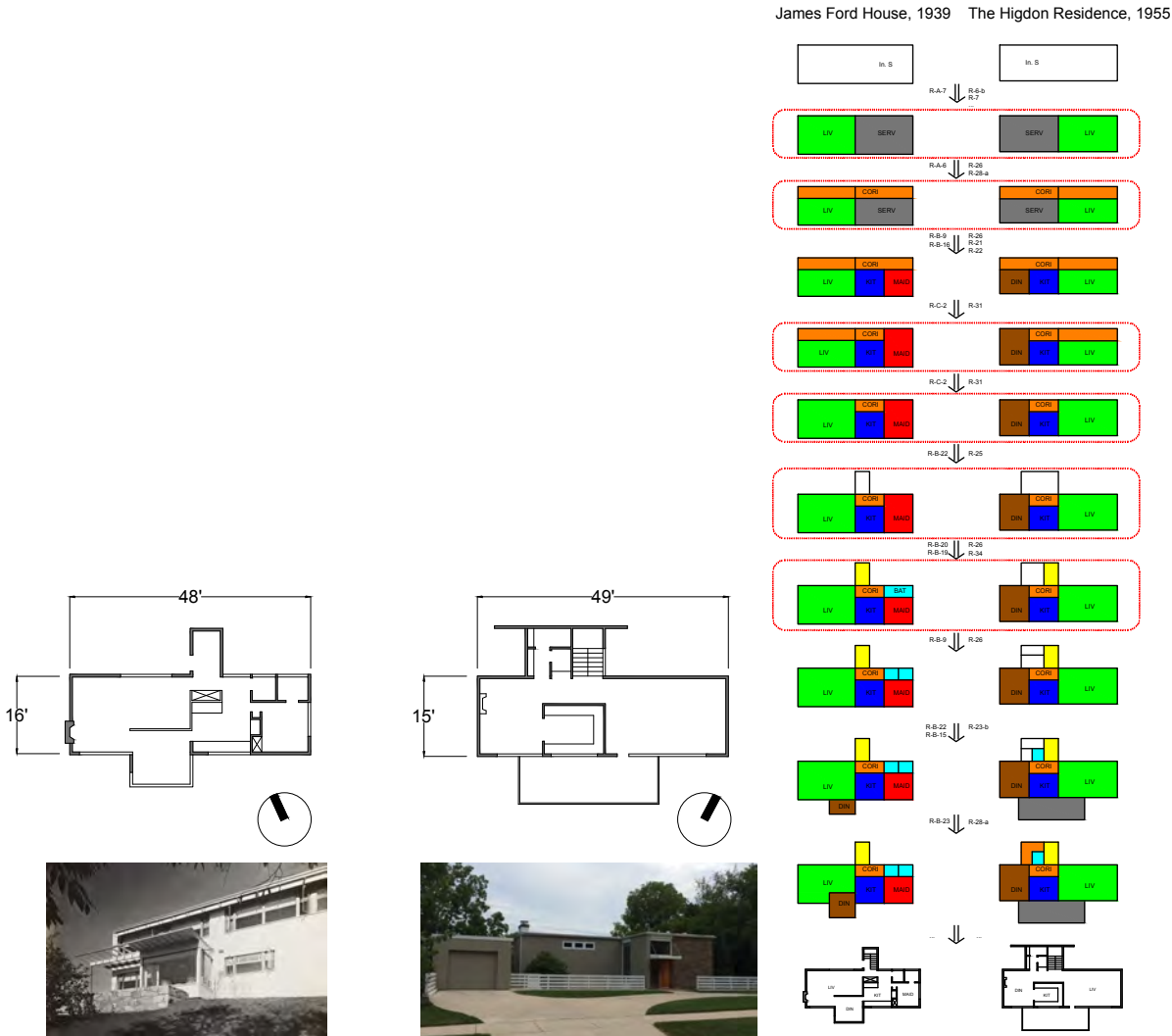

Figure 2: Comparison of a step-by-step derivation of the James Ford House designed by Gropius-Breuer (left) and the Higdon Residence designed by Hajjar (right). Note that in each step, different rules may apply to each derivation. Steps with similar results are highlighted with a red border.

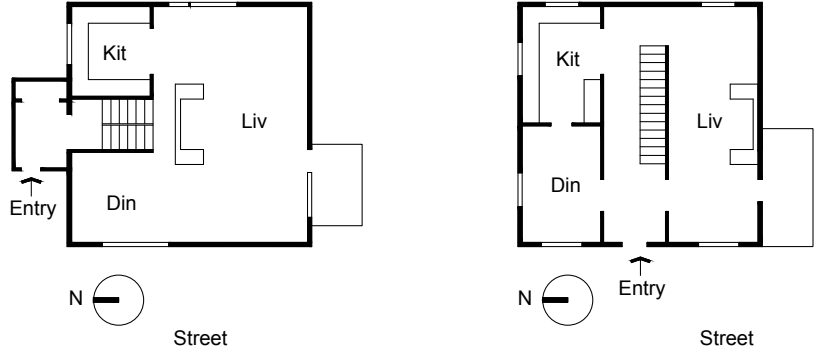

Figure 3: Hajjar's Snowdon Residence, constructed in 1959 in State College, PA (left), and a house of the same size with a similar layout generated by the grammar for American traditional architecture (right).

It remains important to understand that although similarities and differences between the grammars reflect similarities and differences between the work of the respective architects and the respective architectural styles, they also relate to the lifestyle and culture characteristic of given periods and regions. For example, the size and proportion of the interior spaces, such as the kitchen, the living room, and the bedrooms, in designs generated by the grammar for Hajjar's work and the grammar for American traditional architecture may relate to a change in family size between the two periods and/or to a change in the role of women in social relationships in the mid-twentieth century United States.

3.0 IMPLEMENTING SHAPE GRAMMAR METHODOLOGY IN THE PEDAGOGY OF HISTORIC PRESERVATION AND DESIGN

Given that shape grammar's efficacy as a tool for identifying and explaining hybridity in architectural design has been clearly demonstrated, the steps explained in the previous section can be used in reverse to generate rather than to describe and analyze hybrid designs. The process described is designed to meet the central goal of analyzing the qualities of Hajjar's architectural language to determine how it reflects the influences of European modernism and American traditional architecture. However, it also provides a way to quantify these influences, i.e., to show the percentage of Hajjar's architectural language that reflects influences from and similarities with the other grammar. This means that by mixing rules from different design languages, it is possible to define a new grammar with a hybrid design language.

In 2017, the author participated in a workshop organized by Jose Duarte and Lissa Iulo in Croatia titled "Customized Sustainable Housing for Split." The idea of the workshop was to generate designs based on rules extracted from the traditional residential architecture of Split, Croatia. Although the grammar produced in the workshop by the author was not a hybrid grammar, as it was based entirely on the traditional residential architecture of Split, the process made it clear that with the addition of layers to the grammar—for example rules that represent current architectural trends whether local or international—it is possible to generate hybrid designs. Following this idea, the author organized a workshop on the local adaptation of modern architecture focusing on the hybridity between the Persian Garden style and the International Style to generate architecture appropriate to Shiraz, the ancient capital of Iran, and the birthplace of the Persian Garden concept. The workshop was hosted by Hafez University in Shiraz in 2019.

The twenty-one graduate students of architecture and historic preservation who participated in the workshop were given the assignment of designing a hybrid architectural pavilion in order to connect—in a meaningful and historically satisfying way—the world's architecture/International Style with the style of local Persian architecture. The students were introduced to the grammar previously developed for the Mughal Garden by Stiny and Mitchell (1980) and the grammar produced for the Gropius-Breuer partnership by the author. The rules from the Mughal Garden grammar were modified to specifically reflect the Persian Gardens of Shiraz. Then, the students developed rules to express hybridity between the two grammars or architectural styles—the Persian Garden and the modern architecture of Gropius and Breuer. Figure 4 is an example of the results of the workshop.

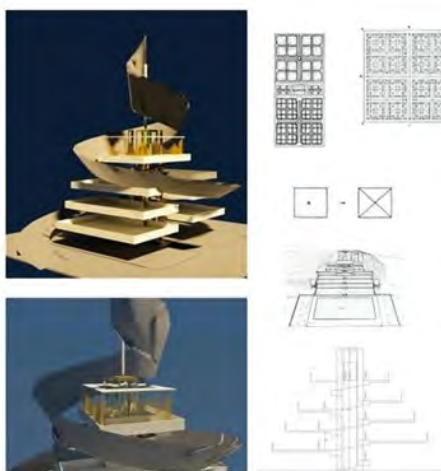

Figure 4: Example of a group project designed by students during the workshop in Shiraz 2019. While the final project is shown at left, the design process including analysis of the Persian Garden style and rules developed for the hybrid grammar are shown at right.

In another exploration of the idea of generating designs that are both compatible with the context—in terms of form, geometry, and architectural language—and reflective of present-day lifestyle and architectural trends, the author used the shape grammar methodology in an upper-level undergraduate preservation and design studio with eleven senior-level students at Texas Tech University College of Architecture. Titled "The Neue Galerie, New York: Understanding the Past; Envisioning the Future," the studio project focused on designing an addition to the privately owned Neue Galerie in New York City.

The Neue Galerie is located in an area known as Museum Miles—a mile-long stretch of Fifth Avenue that is home to some of the most well-known museums in the world, including the Guggenheim and the Metropolitan Museum of Art. Designed by Carrère and Hastings, an outstanding American Beaux-Arts architecture firm responsible for the design of the New York Public Library, the existing Neue Galerie building—designated a historic landmark by the New York Landmark Commission—is generally considered one of the most distinguished buildings on the avenue (Figure 5).



Figure 5: Neue Galerie New York, north elevation, as seen from 86th Street. Source: Neue Galerie website.

The students were asked to design a contemporary addition compatible with the existing historic structure on a prominent site in a dense historic context. Therefore, they had to take all the issues commonly considered in any design studio into account, including the concept, materiality, lighting strategies, spatial organization, and sustainable and environmental values. Additionally, they were required to do so with special consideration afforded to context, historical importance, footfall, and relationship with the existing building.

The students took all the usual steps, including performing a site analysis and a precedent analysis, considering the historical background, determining the zoning requirements and applicable codes, and understanding the design guidelines and sustainable strategies promoted by the Office of Sustainable Design. To create a foundation for their design in light of the challenge relating to compatibility, and specifically to help them achieve a better technical understanding of the influences already in play, the students were introduced to the theory and application of the shape grammar. The process set out in section 1 of this paper pertaining to identifying and explaining hybridity in architectural design was explained to the students. They were then asked to develop some rules to explain the nature of the historical context based on the historical design guidelines. Further, it was necessary to consider the Secretary of the Interior's standards for rehabilitation, as some of the designs entailed changes to the existing historical structure. To reflect the content of the museum, new rules were developed based on the formal analysis of the art known as Vienna Secession exhibited at the gallery. Simultaneously, new rules were developed to reflect the strategies promoted by the New York City Office of Sustainable Design. As many of the guidelines under "Building Energy Use" were developed for spatial design, building envelopes, and fenestrations, and site and massing considerations in new construction, rules developed with these points taken into account did to some extent follow contemporary design strategies. These distinct groups of rules were put together—modified and consolidated in some cases—to develop a hybrid grammar as a basis for generating configurable design ideas.

After developing a hybrid grammar, each student generated twelve to twenty-four designs (Figure 6). Based on each student's project and proficiency with applicable computer programs, this process was performed manually in some cases and in other cases by developing Grasshopper scripts based on the developed grammar. Then, for each project, a design was selected from the generated designs and developed to become the final product. The design selected was based on the individual student's architectural intuition, a program analysis, and comments received from the studio instructor and other reviewers (Figure 7). For each of the successful studio projects, the final product was very much aligned with present-day architectural trends yet simultaneously compatible with the historical context in terms of geometry and design significance.

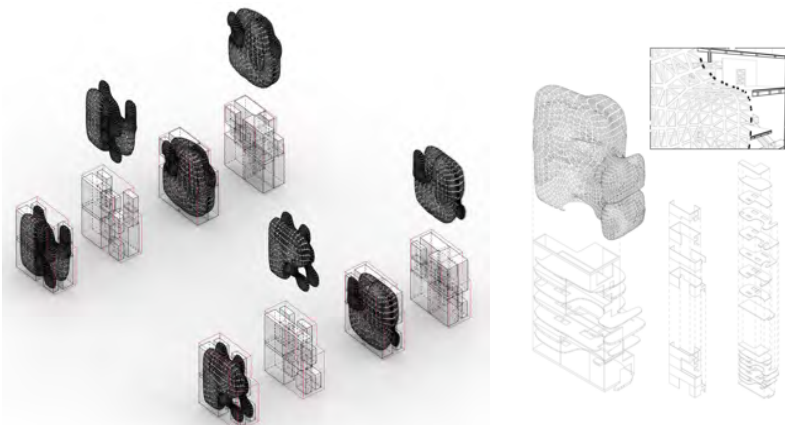

Figure 6: Examples of designs generated by a shape grammar developed by a student (Josh Ruiz) in relation to program analysis. The final design (right) was chosen based on the program analysis.



Figure 7: Final product developed by a student (Ryan Reyes) based on the hybrid grammar.

In a parallel study with a graduate student in the Master of Science in Architecture program with a concentration in historic preservation and design at Texas Tech University, the same methodology was implemented to generate contextualized urban façades in the focal context of Naser-Khosrow Street in Iran’s capital city of Tehran (Zolghadrasli & Hadighi 2021). Shape grammar was used to analyze historical examples of façade designs in the focal area—a significant historical urban street in downtown Tehran that dates back to the Safavid period (1501–1735)—and to generate hybrid façades that are not only compatible with the historical context but also take account of present-day architectural trends, satisfy local architectural regulations and principles, and follow sustainable strategies. In order to generate such hybrid designs the following steps were taken: (1) The characteristic features of the façades of iconic buildings located on the focal street were analyzed (Figure 8). (2) A grammar was developed based on the rules extracted from the façade analysis. (3) Characteristic features of contemporary and sustainable façades—built in 21st-century Iran—were analyzed. (4) Rules were extracted based on the analysis of contemporary and sustainable Iranian façades. (5) A hybrid grammar was developed based on the extracted and modified rules developed in the previous steps. (6) New hybrid designs were generated. (7) The generated designs were compared and contrasted with the original historical designs to determine the extent to which the new designs captured both traditional elements and contemporary architectural trends.

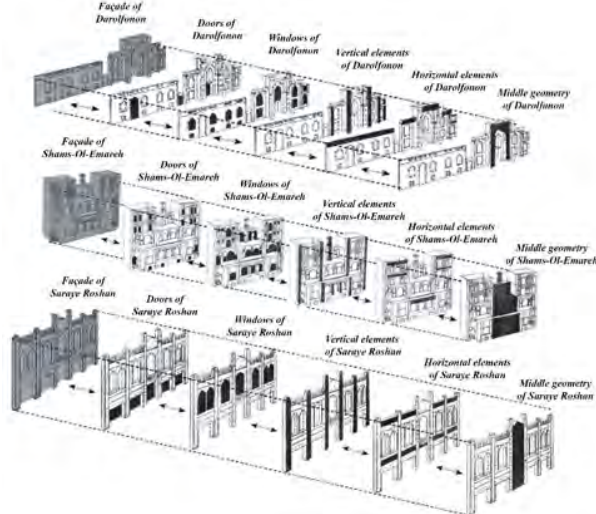

Figure 8: Analysis of the façades of three iconic historic buildings on Naser-Khosrow Street, from top to bottom: Darolfonoon, Shams-al-Emareh, and Sara-ye Roshan. Drawn by Niloofar Zolghadrasli. Source: XX & XX 2021.

4.0 DISCUSSION AND CONCLUSION

As Gwendolyn Wright commented, many architects and historians credit European émigrés with bringing modernism from Europe to the United States, “as if in a suitcase” (2008, 10). However, in Wright’s view, this is a myth that should be dispensed with. Regardless of the origin(s) of American modernism, this myth appears to be a reason why modernism/International Style was not accepted easily by the American public. As described earlier, the duality

between modern and traditional, international and local, and designed and vernacular in the practice of architecture has been addressed in both the literature and practice in a number of different ways. Since the mid-twentieth century, several architects from all around the world have tried to localize the elements of modern architecture. Among them, William Hajjar combined the forms, rules, and principles of modern architecture and traditional architecture in such a way that his work became popular in the region where he practiced at least. Lessons can be learned from this notion of hybridity in Hajjar's architectural language and applied to the future of architectural design in various aspects. In previous papers, shape grammar is shown to be an effective computational design methodology for considering the architecture of the past. However, in order to demonstrate that architecture evolves through a hybridization process, the goal of the present paper is to imagine an architecture of the future by applying a process of hybridization to generate new architectural style appropriate to a given context. Shape grammar has been used to analyze examples of historical architecture related to a particular architect, architectural style, or period. In the present paper, however, it is used to generate hybrid designs, i.e., designs that are simultaneously compatible with the historical context and compatible with present-day lifestyles, building codes, zoning regulations, sustainability strategies, and architectural trends.

REFERENCES

- Benros, D. 2018. *A generic housing grammar for the generation of different housing language*, Ph.D. Dissertation. London's Global University Bartlette School of Graduate Studies.
- Chase, S., and Ahmad, S. 2005. "Grammar Transformations: Using Composite Grammars to Understand Hybridity in Design with an example from Medieval Islamic Courtyard Buildings". *Proceedings of CAAD Futures*, 89-98.
- Çolakoğlu, B. 2005. "Design by Grammar: An Interpretation and Generation of Vernacular Hayat Houses in Contemporary Context." *Environment and Planning B: Planning and Design* 32, 141-149.
- Devlin, K. and Nasar, J. 1989. "The Beauty and the Beast: Some Preliminary Comparisons of 'High' Versus 'Popular' Residential Architecture and Public Versus Architect Judgments of Same." *Journal of Environmental Psychology* 9: 333-344.
- Downing, F. and Flemming, U. 1981. "The Bungalows of Buffalo." *Environment and Planning B*, 8, 269-293.
- Duarte, JP. 2005. "Towards the Mass Customization of Housing: The Grammar of Siza's Houses at Malagueira." *Environment and Planning B: Planning and Design*, 32, 347-380
- Eloy, S. and Duarte, JP. 2011. "Transformation Grammar for Housing Rehabilitation." *Nexus Network Journal*, 49-71
- Figueiredo, B. Sousa, L. Duarte, JP., Kruger, M. 2014. "Alberti Digital on Portuguese Architecture." *Joelho*, 5, 43-51.
- Flemming, U. 1987. "More Than the Sum of Parts: The Grammar of Queen Anne Houses," *Environment and Planning B: Planning and Design* 14: 323-350.
- Frampton, K. 1983. "Towards a Critical Regionalism: Six Points for an Architecture of Resistance." In *the Anti-Aesthetic-Essays on Postmodern Culture*, ed. by Hal Foster, 16-30. Seattle: Bay Press.
- Habraken, J. 1988. "Types as a Social Agreement." *Asian Congress of Architects*, Seoul.
- Hadighi, M. 2021. "Towards a Configurable Hybridity in Historic Preservation and Design." In *Towards New, Configurable Architecture, Proceedings of the 39th eCAADe Conference*, Novi Sad, Serbia, 293-302.
- Hadighi, M. and Duarte, J. 2020. "Local Adaptation of the International Style: Contextualizing Global Architecture between East and West." In *Anthropological Architecture and Fabrication in the Cognitive Age, Proceedings of the 38th eCAADe Conference*, Berlin, Germany, 331-340.
- Hadighi, M. and Duarte, J. 2019. "Bauhaus Internationalism to College Town Modernism: Exploring Bauhaus Culture in Hajjar's Hybrid Architecture." In J-H. Lee (ed.), *Computer-Aided Architectural Design. "Hello Culture"*. Daejeon, Korea: Springer, 429-443.
- Hadighi, M. and Duarte, J. 2019. "Using Grammars to Trace Architectural Hybridity in American Modernism." *Proceedings of the 37th eCAADe conference*, Porto, Portugal, 529-540.
- Hadighi, M. and Duarte, J. 2018. "Adapting Modern Architecture to a Local Context: A Grammar for Hajjar's Hybrid Domestic Architecture." In *Computing for a Better Tomorrow, Proceedings of the 36th eCAADe Conference*, Lodz, Poland, 515-524.
- King, A.D. 2007. "Internationalism, Imperialism, Postcolonialism, Globalisation: Framing Vernacular Architecture." *Perspectives in Vernacular Architecture* 13, no. 2: 64-75.
- Knight, T. 1983. "Transformations of Languages of Designs: part 3." *Environment and Planning B: Planning and Design*, 10, 155-177.
- Koning, H. and Elizenberg, J. 1981. "The Language of the Prairie: Frank Lloyd Wright's Prairie Houses." *Environment and Planning B*, 8, 295-323.
- Lara, F.L. 2008. *The Rise of Popular Modernist Architecture in Brazil*. Gainesville, FL: University Press of Florida.
- Stiny, G. and Gips, J. 1971. "Shape Grammars and the Generative Specification of Painting and Sculpture." *Information Processing 71*. C.V. Freiman (ed.). Amsterdam: North Holland.
- Stiny, G. and Mitchell, J. 1978. "The Palladian Grammar." *Environment and Planning*, B 5, XX-XX
- Umbach, M. and Huppauf, B., ed. 2005. *Vernacular Modernism: Heimat, Globalization, and the Built Environment*. Stanford, CA: Stanford University Press.
- Upton, D. and Vlach, J.M., ed. 1986. *Common Places: Readings in American Vernacular Architecture*. Athens and London: The University of Georgia Press.
- Wright, G. 2008. *USA, Modern Architecture in History*. London: Reaktion.
- Zolghadrassli, N. and Hadighi, M. 2021. "Towards a Systematic Methodology to generate Sustainable Hybrid Façades." *Proceedings of the 16th Advanced Building Skins Conference & Expo*, Bern, Switzerland, 147-156.

Evaluation of the Bioclimatic Building Performance in Hot Climate

Abdou Idris¹, Abdoukader Ibrahim¹, Assabo Mohamed¹

¹Université de Djibouti, Faculté d'Ingénieurs, CEALT/LME², Djibouti, DJIBOUTI

ABSTRACT: To reduce the energy consumption of buildings, a solution known for decades, consists of designing its envelope to exploit the energy resources existing in the environment. This is the very principle of so-called bioclimatic architecture. This is also true for hot climates. But up to now, the lack of criteria to identify the energy resources available in the environment and the level of performance of the technical solution has been a major obstacle. To solve this problem, we apply a practical approach for decision-making regarding passive cooling design for buildings under hot climates. This approach is based on a set of indicators that provide an overview of the exploitable environmental resource (external air through external convection, natural ventilation, and sky radiation cooling) referred to as the Environmental Resource Indicators and of the capacity of the building to exploit those resources referred as the Building Performance Indicators. Based on a study of a typical residential building in Djibouti, the analysis gives hints for better designer understanding of building interactions for the studied passive cooling solutions: external shading device, cool roof, external Insulation and natural ventilation. The results show not only the ability of the approach to reflect the bioclimatic performances of the buildings but also their ability to give an overview of the building heat exchanges, from which the implication of improper bioclimatic solutions on building cooling consumptions can easily be identified. This contribution will ultimately provide the basis for future thermal regulations of buildings in countries with hot climates, in general, and in Djibouti, in particular.

KEYWORDS: Environmental resources, Bioclimatic indicators, Performance indicators, Building envelope, Hot climate

INTRODUCTION

In developing countries, the proportion of the urban population is projected to increase from 47% in 2011 to 65% by 2050 (UN-HABITAT). This trend toward urbanization requires the construction of new buildings, but very often, those new buildings are designed without any consideration of energy efficiency and bioclimatic rules. Furthermore, many sub-Saharan African countries do not have energy regulations. Having full air conditioning is considered a necessity for these new constructions to be comfortable for occupants all the time in hot countries. These two factors (poor building performance and extensive use of air conditioning) increase the use of energy to achieve thermal comfort. For example, in Djibouti, electricity demand remains dominated by cooling needs and ventilation, which together account for more than 70% of consumption (Abdou 2020).

The principle of passive cooling techniques has been successfully used for centuries before the appearance of air conditioning. However, the economic growth and the standard of living improvement of the population in hot regions have favored the expansion of air conditioning use. Thus, having full air conditioning is considered a necessity for new constructions to be comfortable for occupants all the time. The indoor conditions which are achievable in fully bioclimatic buildings are not anymore compatible with the current standard of living that future occupant expect.

In this context, a bioclimatic design intends to a) protect the indoor environment from outdoor heat sources, b) exploit sources of freshness from outdoor environment, and c) make use of thermal inertia to manage the fluctuation of the outdoor freshness availability. The authors believe that their new approach is suited to quantify the performances of the buildings to follow at least the first two bioclimatic design goals. For these reasons, bioclimatic design is an alternative solution in new constructions. The ultimate achievement of the bioclimatic design is to obtain a fully passive building, which produce thermal comfort without mechanical system. However, the context of this study is the hot and humid climate. In this context, the weather pattern leads to the widespread use of air-conditioning systems and, thus, high electricity consumption. Consequently, this paper is restricted to fully space-conditioned buildings in a hot climate. In this context, bioclimatic strategies would take advantage of locally available environmental sources of freshness (air or sky vault) to minimize the cooling energy consumption of the buildings. Different strategies exist to protect the building from sun heat loads such as shading devices (Butera, Adhikari, et Aste 2014; Edmonds et Greenup 2002; Mazria 1979), surrounding vegetation (B. Givoni 1991; Liu et Baskaran 2003; Yu et Hien 2006), angular and spectral selective coatings (Reppel et Edmonds 1998; Lorenz 2001; Smith, Dligatch, et Jahan 1998; Granqvist et al. 2010) and double-skin facades or roofs (Ciampi, Leccese, et Tuoni 2003; Hamza 2008; Omar et al. 2017)]. Other technical solutions exist to exploit cooling from the environment, such as night sky cooling systems (Yannas, Erell, et Molina 2006; Raeissi et

Taheri 2000; Baruch Givoni 1994), natural ventilation (Santamouris et Asimakopoulos 1996; Saadatian et al. 2012; Aflaki et al. 2015) and ground cooling (Draoui et al. 2015). All these techniques need, from early stage of design, devoted analysis tools regarding the amount of available energy they could exploit. These tools are based on their own indicators. In a previous paper (Idris et al. 2020), the authors developed a new approach to evaluate the amount of cooling (or heating) energy that could be exploited (or sheltered) from the environment at a given location, and to assessing the capacity of the building and its systems to exploit (or shelter) those environmental cooling resources (or heat sources).

This paper aims at investigating the application of the new approach summarized in this paper to analyses the interaction between the envelope and its surrounding environment as well as the bioclimatic building performance in Djibouti. We analyzed the simulated results for a residential building through proposed Environmental Building Indicators (ERIs) and Building Performance Indicators (BPIs). We evaluated and compared the energy performance of some strategies considered bioclimatic with regard to indoor and outdoor environments:

- ✓ External shading device
- ✓ Cool Roof
- ✓ External Insulation
- ✓ Natural Ventilation

It is also important to note that these solutions are not optimized. The idea is to discuss the pertinence and relevance of using the new approach presented in this study to highlight and redefine the bioclimatic performance analysis.

1.0 METHODOLOGY

1.1 The new approach to evaluate the bioclimatic performance

In a previous paper (Idris et al. 2020), the authors proposed a new approach and a set of indicators illustrated in scheme given in Figure 1. These indicators could be an asset in the bioclimatic design procedure and help the building designers to properly select bioclimatic technologies in the context of using bioclimatic resources to reduce the cooling needs.

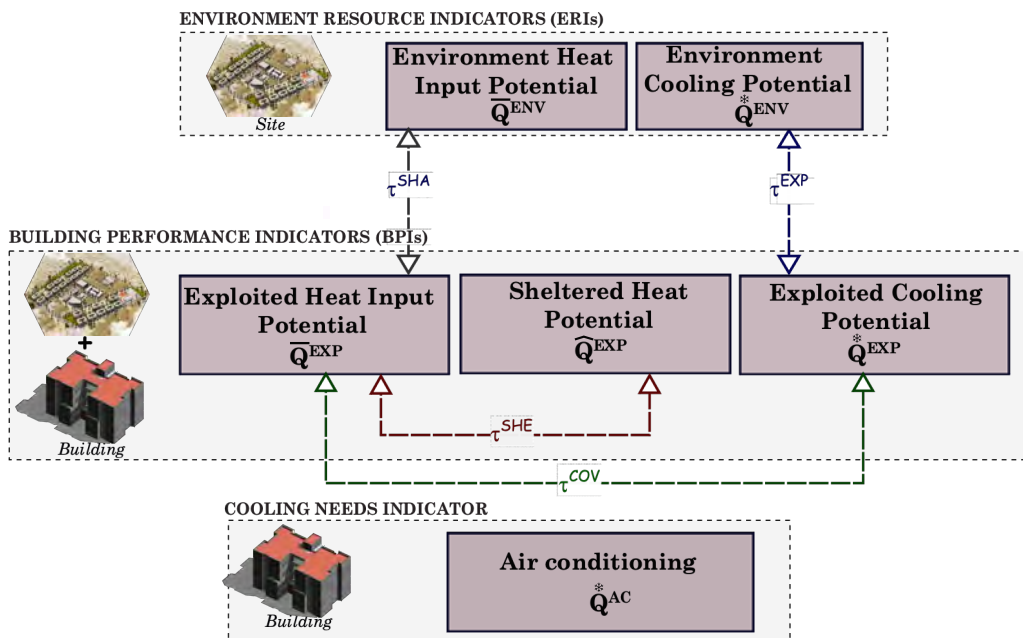

Figure 1: Overall view of the approach and the indicators

The bioclimatic indicators defined are energy potentials. The energy potentials are daily integrations of the incoming/ outgoing part of heat fluxes through the building envelope. The potential \bar{Q} is the integral of the negative part of heat flux Φ passing through the building envelope, which represents a cooling or sheltering potential for the building. The anti-potential \bar{Q}^* is the integral of the positive part of the heat flux, it represents the heat input for the building, as illustrated in Figure 2.

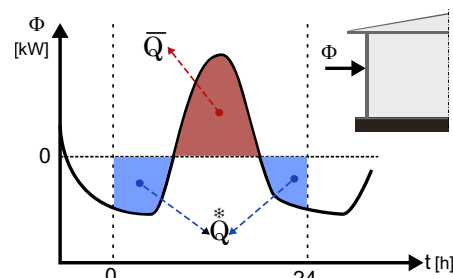

Figure 2: Basic computation principles for the energy potentials

The first set of energy potentials depends only on the construction location and the building dimensions. It evaluates, for each environmental elements (sun, external air through external convection, natural ventilation and sky radiation), the maximum available cooling energy Q^{*ENV} and the maximum heat input \bar{Q}^{ENV} . The related energy potentials are called environmental resource indicators (ERIs). They are computed from a so-called virtual highly permeable building (Idris et al. 2020) (VHPB) model.

The second set of energy potentials evaluates, for each environmental resource, the actual quantity of cooling energy that is utilized by a building, with a specific set of construction solutions. These are principally conceived to orientate the choice of designer toward pertinent solutions that optimize the exploitation of bioclimatic resources. The related energy potentials are called Building Performance Indicators (BPIs). The BPIs are calculated from building energy simulation outputs (BES). BES programs (EnergyPlus, Trnsys, DO2, etc.) provide access to all the computed heat fluxes that are needed to compute the BPI [ref]. Since flux amplitudes are much larger on the exterior surface than on the interior surface of the building envelope, the author distinguished between the outdoor and indoor exploited potentials. For the outdoor side, \hat{Q}^{EXP} represent the heat input potentials by each environmental heat source (shortwave radiation, convection, and longwave radiation). The \hat{Q}^{EXP} is the sheltering potentials. They are named the sheltering potentials because they mostly compensate the heat inputs; they rarely refresh the indoor environment. The sheltering effect is symbolized by the hat symbol over the letter Q .

For the indoor exploited potentials, it is quite difficult to distinguish between the shortwave radiation, the longwave radiation and the external convection components of the heat flux transmitted by the envelope. The residual exploited potential Q_{res}^{*EXP} results from convective and radiative cooling on the external side of the envelope. The exploited heat input potential \bar{Q}_{res}^{EXP} results from convection, longwave radiation and sun radiation heating on the external face of the building, including the shortwave radiation that passes through the windows. We also calculate within the same volume the potential Q_{vent}^{*EXP} , the exploited natural ventilation potential, and \hat{Q}^{*AC} , the cooling power provided by the air conditioning system to maintain the internal temperature below T_{ac} .

The last set of indicators provides four representatives ratios:

- the cover rate, τ^{COV} , that relates the exploited cooling energy from a specific resource to the internal heat loads through the envelope.
- the exploitation rate, τ^{EXP} , that relates the exploited cooling energy from a specific resource to the environmental cooling energy that would be exploitable for that specific resource.
- the sheltering rate, τ^{SHE} , represents the capacity of the envelope to act as a barrier facing the external heat sources.
- And the shading rate, τ^{SHA} , that relates the building shape and quantify the part of available environment heat input energy that would be avoided by the morphology of the building.

In this paper, the previously developed bioclimatic performance analysis criteria are applied to an existing residential building in Djibouti and evaluate the influence of some bioclimatic strategies. The main purpose of this case study is to show the nature of the information that can be drawn from the analysis of the indicator values and to demonstrate their applicability to different configurations.

1.2. Weather data for Djibouti

Characteristic features of the weather of Djibouti are displayed in Figure 3. Djibouti is classed under under the Koppen-Gigger hot desert climate classification "BWh" Figure 3a (Peel et al. 2007). The monthly distribution of solar radiation is displayed in Figure 3c. The solar radiation is constantly high throughout the year. The Monthly average daily irradiation oscillate between 7.5 kWh/m².day à 8.5 kWh/m².day with more direct component (on average, 60%). The monthly distributions of the outdoor air and sky temperatures are displayed in Figure 3d. The sky temperature was determined using an equation suggested by Centeno (Centeno 1982) and Clark and Allen (Clark et Allen 1978). The sky temperature is often lower than the ambient air temperature, and the difference is higher between November and March. The weather of Djibouti is characterized by very low rainfall and very high humidity. The monthly averaged outdoor air temperatures oscillate between 25°C and 35°C. The cool season, from November to March, is hot and very humid, with an east trade wind coming from the sea (figures 3b&3e). The summer season, from April to October, is very hot and slightly dryer, with west prevailing winds coming from the continent at a low speed (<5 m/s). Buildings under this climatic condition will exchange heat with different environmental elements: the sun, the sky, the outdoor air or the outdoor surfaces. Obviously, the sun will never be a cooling resource; its characteristic temperature is obviously too high. The building exchanges heat with the outdoor air mainly through external convection (on the building envelope) and natural ventilation (through window openings). Since those heat transfer modes are very different, the authors distinguish the outdoor air-cooling resource by convection (external convection resource) and by ventilation (ventilation resource). The buildings exchange heat with the outdoor surfaces by longwave radiation. The external surfaces include the ground, the walls of the surrounding buildings and the sky vault. The sky is considered as a cooling resource. To summarize, the authors have identified three environmental cooling resources: external convection, ventilation and the sky radiation.

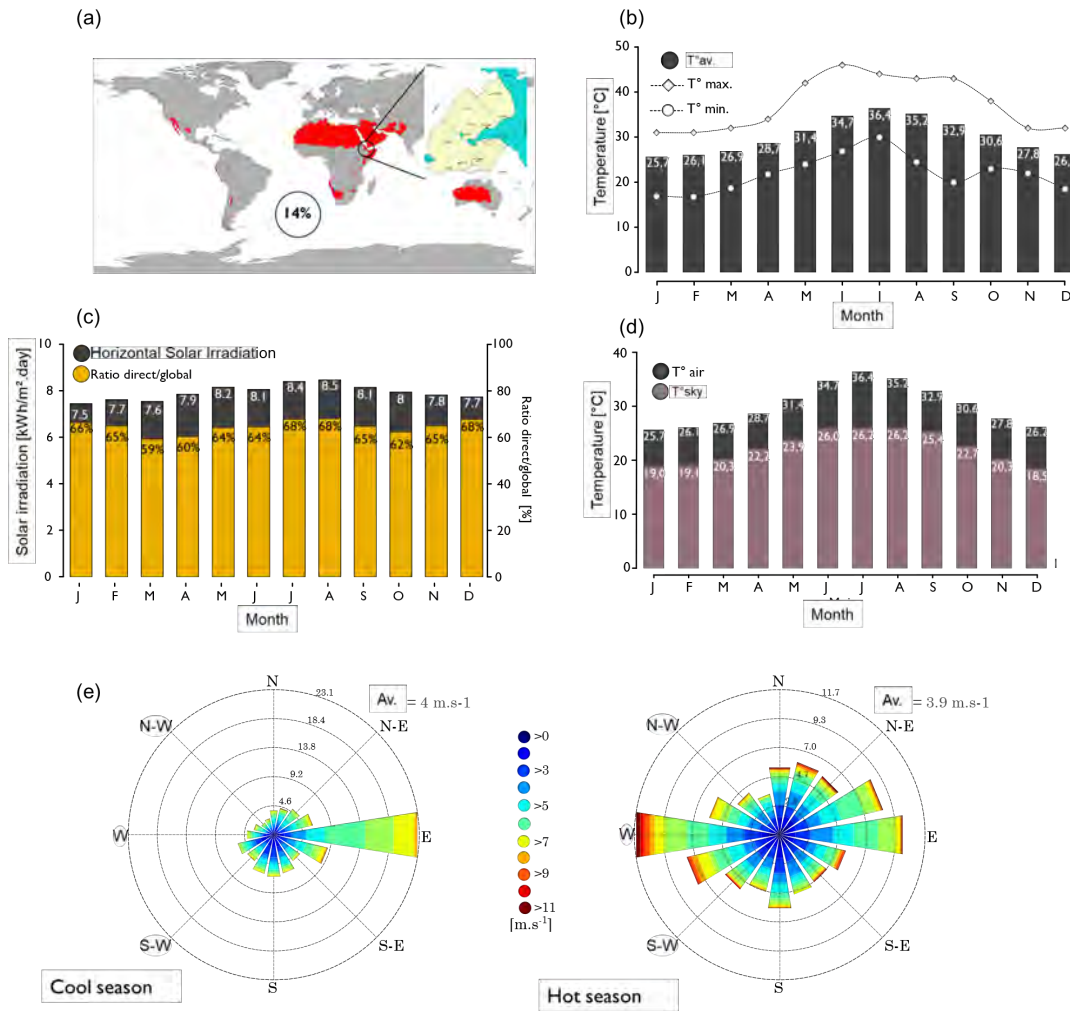

Figure 3 : Weather data in Djibouti (a) Countries under the Koppen-Giger hot desert climate classification "BWh". (Peel et al. 2007) (c). (b) Monthly mean temperatures - max, min and avg. (c) Monthly average daily irradiation and direct to global ratio. (d) Comparison of sky and air monthly avg. temperature. (e) Wind roses for the cool and hot season.

1.3. Description of the studied residential building

The studied building (Figure 4) is a typical residential building in Djibouti. In fact, such buildings are constructed by thousands as part of national project to increase the housing sector. It was modeled using DesignBuilder software (EnergyPlus), which is a validated program for building energy simulation. For the energy model, only one zone per block has been modelled. It consists of two blocks of buildings with a surface area of 158 m² connected by a stairwell in the center so that the whole has an H shape. The building is located in a new urban district called PK13 (the southwestern periphery of Djibouti-city). It is a G+3 building with a total floor area of 925 m² and a ceiling height of 3.2 m. The building has a low window-to-wall ratio (WWR of 7%) with horizontal sliding windows facing north and south. The vertical walls are composed of 2 cm of cement screed and 2 cm of internal cement screed. The windows consist of simple clear glass with aluminum frame. The 25 cm roof (reinforced concrete, and cement mortar with a smooth finish) is not protected from sun radiation. The slab (20 cm reinforced concrete, 5 cm mortar screed and tiles) is on a sandy ground. The Thermal inertia of the building is reinforced by the intermediate floor consisting of a 20 cm concrete slab with a layer of cement screed and tiles. The studied building is not insulated. In fact, thermal insulation in Djibouti buildings is still considered as a luxury only available for high-end buildings. Few building materials merchants sell it at a price of between €20/m² and €50/m² depending on the thickness. For this, the roof has a solar reflectance of 0.27 and a thermal emissivity of 0.9.

There is a lack of studies, in literature review, on infiltration of air through building envelopes in hot climates. The use of sliding system and the lack of airtightness of windows and external doors implies de facto a poor airtightness. This explains our choice to assume a very poor airtightness of 16.5 vol/h at 50 Pa difference between the exterior and the interior, according to the EN 13829 standard for the building envelope. Natural ventilation is not common in the country. Factors such as privacy, dust as well as mosquitoes and other insects limit natural ventilation even if the resource is available for cooling. In this study, air exchange with the outside is minimized in the building by closing the windows throughout the simulation.

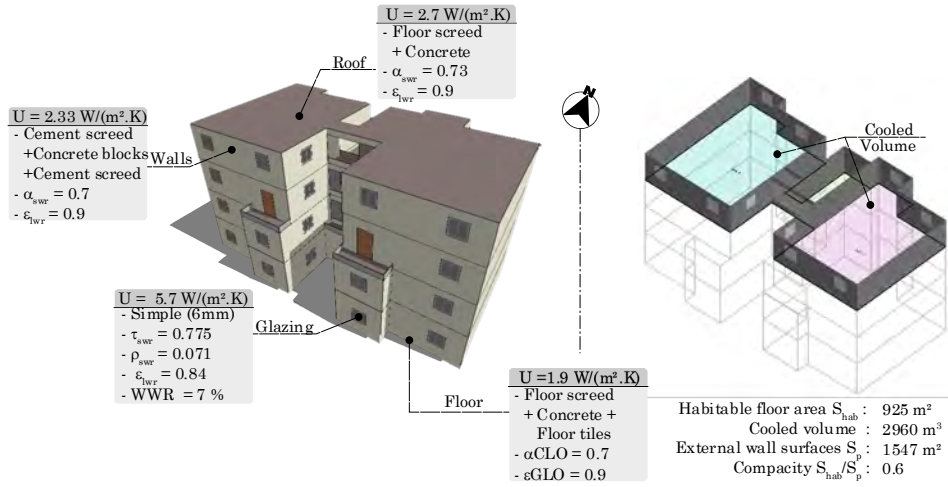

Figure 4 : Geometry model of the residential building in PK13.

An occupancy scenario is integrated into the simulation, Table 1 gives the total internal loads (occupants and electric devices) for one day.

Table 1: Daily occupancy and internal heat

0h - 5h	6h - 8h	9h - 12h	13h - 15h	16h - 18h	19h - 21h	22h - 23h
0.5 W/m ²	5 W/m ²	1 W/m ²	3 W/m ²	1 W/m ²	5 W/m ²	1 W/m ²

A cooling system is set to maintain the cooling setpoint temperature $T_{ac} = 26^\circ\text{C}$ when the building is occupied. No heating system is present in this building.

1.4. Thermal models for constructive solutions tested.

The bioclimatic performance of building four variants based on the reference case are investigated through the proposed indicators. It is important to note that the studied measures have not been optimized. The first investigated solution is an external solar shading of windows, one of the most typical bioclimatic building techniques in a hot climate. There are many architectural solutions for shading devices, but in this paper, only louvered shading systems in windows are studied. High-density local shading with 12 louvres inclined at 20° and spaced 10 cm apart, placed 10 cm from the window, were added to the windows of the basic variant (Figure 5.a). This variant was then compared with the initial configuration without external solar protection on the windows. The cool roof solution here consists of a roof-covering layer that limits the absorption of solar radiation by a high solar reflectivity, while emitting the accumulated heat towards the sky due to its high thermal emissivity. In fact, the façades of the building envelope that are in contact with the external environment, the roof is the most vulnerable due to its high level of solar radiation (around 33% of the building annual incident solar irradiation). Here, a solar reflectivity of 0.7 (against 0.27 for the reference case) was considered while maintaining the emissivity of the reference case (0.9) as shown in the Figure 5.b The effect of the reflectivity and emissivity properties combined gives a high solar reflectance index (SRI) of 86%. The third investigated solution is the thermal insulation of the building envelope. As far as it was possible to see, the basic composition of the walls has no thermal insulation. Insulation is quasi-inexistent in Djibouti. This observation can only invite us to question the influence of the thermal resistance of insulation on bioclimatic analysis. As the initial model has no insulation, a highly insulated model with an envelope insulated with 20 cm of extruded polystyrene (XPS) is studied. The composition of the external walls for this model is shown in the following Figure 5.c

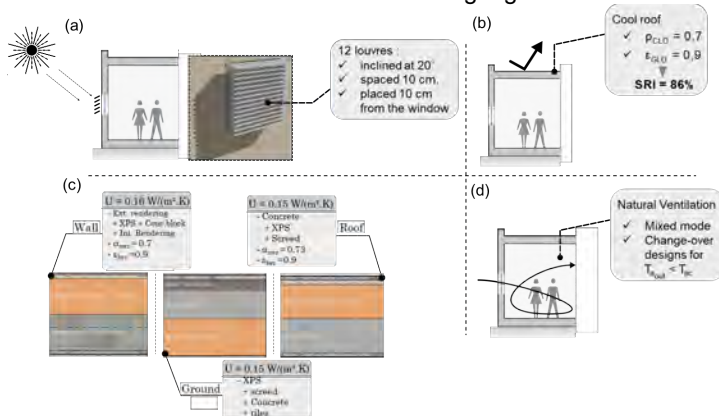

Figure 5: The four bioclimatic solutions tested: (a) solar shading device, (b) cool roof, (c) External insulation, (d) Natural ventilation
Evaluation of the Bioclimatic Building Performance in Hot Climate

Finally, the natural ventilation (NV) is ensured by mixed mode cooling. The later refers to a hybrid approach to space conditioning that uses a combination of natural ventilation from the horizontal sliding windows of the building, and air conditioner. The building change-over between NV and air-conditioning on a daily basis according to outdoor and indoor air temperatures ($T_{aout} < T_{ac}$). The choice of the limit for cooling and natural ventilation criteria is decisive for both the cooling potential of the natural ventilation and cooling needs.

2.0 RESULTS AND DISCUSSIONS

2.1. Bioclimatic analysis of the reference case

The results presented in this paragraph are aimed at evaluating the relevance of constructive solutions on a building. To do this we need to know the reference bioclimatic performance of the building model as defined in the previous section 1.3. Here, the energy potentials are presented as annual potentials (sum over the year of the daily potentials). All the energy potentials were divided by the total cooled floor area. Figure 5 shows the decomposition of the external (left-side) and internal (right-side) potentials for the reference case. Each subfigure provides a snapshot of the year-round bioclimatic performances of the building configuration. The vertical scale is different between the indoor and outdoor indicators because the orders of magnitude of the fluxes are different.

Table 2 : Values of the relative indicators of the initial configuration

Sky & external convection		Natural ventilation		sun	
τ^{EXP}	τ^{COV}	τ^{EXP}	τ^{COV}	τ^{SHE}	τ^{SHA}
7.3%	6.4 %	4.6%	1%	89.2%	19.8%

This presentation of the results provides a clear visualization of the heat balance, i.e. the equality of the incoming and outgoing flows in the interior volume of the building. In addition, Table 2 shows the values of the relative indicators of the reference building.

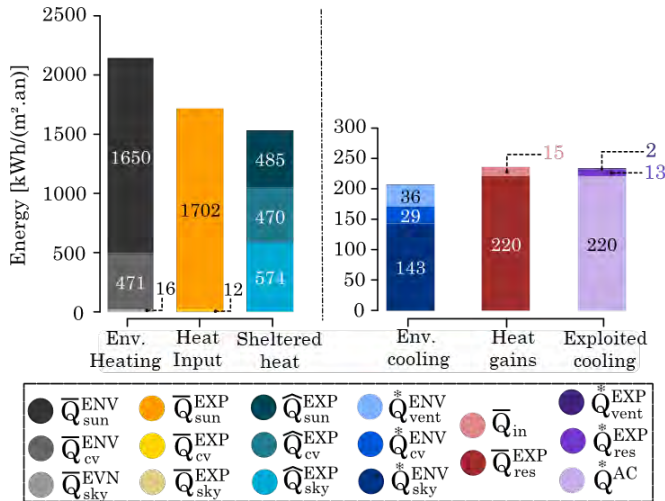

Figure 6: Comparison between the annual ERIs and BPIs (kWh.m². yr) for the studied building.

The results of the external indicators show firstly that less heat input potential ($\sum_i \bar{Q}_i^{EXP}$) impact on the building envelope compared to the available environment heat input ($\sum_i \bar{Q}_i^{ENV}$). Indeed, as the building envelope has a high thermal inertia, the external surface temperature rarely decreases below the external air temperature. This results in a systematically very low \bar{Q}_{cv}^{EXP} compared to \bar{Q}_{cv}^{ENV} (471 kWh/m².yr versus 12 kWh/m².yr), and a \bar{Q}_{sky}^{EXP} equal to zero. Most of the building heat input comes directly from sun radiation \bar{Q}_{sun}^{EXP} . In contrast, the reference building shape as it is currently constructed, with the setbacks in the middle of the south and north facades, exposes more external surfaces to the sun compared to its very compact shape (Virtual Highly Permeable Building). This implies an increase of the exploited heat input potential \bar{Q}_{sun}^{EXP} (from 1650 to 1702 kWh/m².yr). Overall, the building shading rate τ^{SHA} is 20% as shown in Table 2. This means that 80% of the environment available heat input on the site, most of which comes directly from solar radiation, will be absorbed by the external building envelope (1714 kWh/m².yr). A large part of the incoming radiation is directly reflected by the envelope ($\bar{Q}_{sun}^{EXP}=1529$ kWh/m².yr). Then, it is evacuated to the outdoor environment by longwave radiation and convection. Thus, the sheltering rate τ^{SHE} of the reference case is 89.2 % The

fact that the convection sheltering potential \hat{Q}_{cv}^{EXP} is lower than the sky sheltering potential \hat{Q}_{sky}^{EXP} is valuable because the energy associated with \hat{Q}_{sun}^{EXP} directly heats up the air around the building, which might result in outdoor discomfort near the building. Thus, the sheltering rate τ^{SHE} of the reference case is 89.2%, i.e., an exploited heat input permeability of about 11%. Therefore, the initial configuration exposes the indoor environment to a large residual exploited heat input ($\bar{Q}_{res}^{EXP} = 220 \text{ kWh/m}^2 \cdot \text{an}$). \bar{Q}_{res}^{EXP} is the actual amount of heat that travels through the envelope and reaches the indoor environment. The latter remain higher than the sum of the environmental available cooling potentials ($\bar{Q}_{vent}^{ENV} + \bar{Q}_{cv}^{ENV} + \bar{Q}_{sky}^{ENV}$). This leads to a very high cooling need ($\bar{Q}^{AC} = 220 \text{ kWh/m}^2 \cdot \text{yr}$). If we compare this with the context in France, it is interesting to note that this need is equivalent to the energy consumption of low-income households in social housing of low thermal quality in France (built before the 1980s) in moderate cold climates. This analysis also shows the building's difficulty in transmitting the cooling energy from external environment through the envelope. Normally, bioclimatic resources should be able to cover a large cooling demand if they could be properly exploited. Rather, the envelope of the reference case use only 15 kWh/m²·yr of the available cooling ($\sum_i \bar{Q}_i^{EXP}$), an exploited rate τ^{EXP} of the three resources combined less than 8%. This exploitation only covers about 6% of the residual exploited heat input (τ^{COV}). In the current reference configuration, the solar shading or bioclimatic cooling techniques are not sufficiently explored. This makes the building permeable to the external heat input. In the following section, the impacts of some solutions on the improvement of the building bioclimatic performance will be evaluated.

2.2. Bioclimatic analysis of the external solar shading device.

The first graph to be analyzed is the previous condensed graph of all indicators for this solution (Figure 7). Regardless of the absolute values, what we are interested in is the percentage change in performance compared to the reference case. The second graph simply reflects this variation. The relative indicators before and after modifications will also be analyzed.

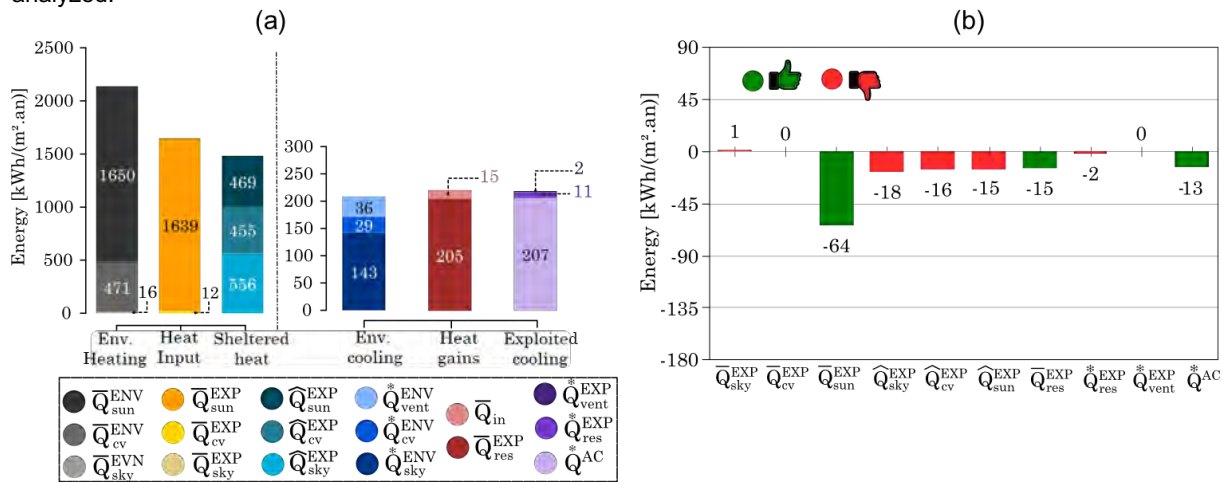

Figure 7 : Bioclimatic analysis of solar shading: (a) - Annual ERIs and BPIs for the solution; (b) - Change in indicators from the reference design.

The results are not unexpected. This solution reduces the exploited solar heat input by the building (\bar{Q}_{sun}^{EXP}). This variant effectively protect from the solar radiation with less than 64 kWh/m²·yr of solar heat input, which is a 3% improvement in the shading rate (τ^{SHA}) compared to the reference (Table 3).

Table 3 : Values of the relative indicators for solar shading solution

Sky & external convection		Natural ventilation		sun	
τ^{EXP}	τ^{COV}	τ^{EXP}	τ^{COV}	τ^{SHE}	τ^{SHA}
6.4%	6%	4.6%	0.9%	89.6%	22.7%

This shading effect is limited by a decrease of the sheltering potentials (\hat{Q}_{sun}^{EXP} , \hat{Q}_{cv}^{EXP} and \hat{Q}_{sky}^{EXP}) proportional to the external shading effect. In fact, a part of the walls and windows exchange less with the available cooling resources and reduce the sheltering potentials ($\sum_i \hat{Q}_i^{EXP}$) by 49 kWh/m²·yr. Regarding the indoor indicators, the change in performance show less residual heat input and therefore a saving in cooling demand of 13 kWh/m²·yr compared to the reference case.

2.3. Bioclimatic analysis of the external insulation

Figure 8 shows that the insulation increases the exploited heat input potential of the external convection by 36 kWh/m².yr (\bar{Q}_{cv}^{EXP}) compared to the reference. This effect on the envelope external surface allows more convection with the air and more radiation towards the sky ($\sum_i \hat{Q}_i^{EXP}$ increase by 173 kWh/m².yr). These two changes result, on the one hand, in a systematically lower shading rate of the available heat input ($\tau^{SHA} = 18,1\%$, 2% less comparing to the initial case) and, on the other hand, in a higher sheltering rate ($\tau^{SHE} = 97.2\%$, 8% more than the reference). Insulation therefore has a positive impact on the external building indicators.

Table 4 :Values of the relative indicators for external insulation case

Sky & external convection		Natural ventilation		sun	
τ^{EXP}	τ^{COV}	τ^{EXP}	τ^{COV}	τ^{SHE}	τ^{SHA}
2.3%	7.5 %	4.3%	3%	97.2%	18.1%

The most remarkable result is the impact of the insulation on the internal building indicators of the envelope. It significantly reduces the heat transmission toward the indoor environment by 144 kWh/m².yr compared to the reference non-insulated building, which result in a less annual cooling need (135 kWh/m².yr saved). With this solution, performance levels almost three times better than the reference case can be achieved. Figure 7 also shows that the reduction of the residual heat input energy (\bar{Q}_{res}^{EXP}) also increases the gap between the environmental cooling resources potential and the building cooling needs, what we can call the “bioclimatic margin”. Insulation increases the amount of cooling potential available to cover the residual exploited heat input.

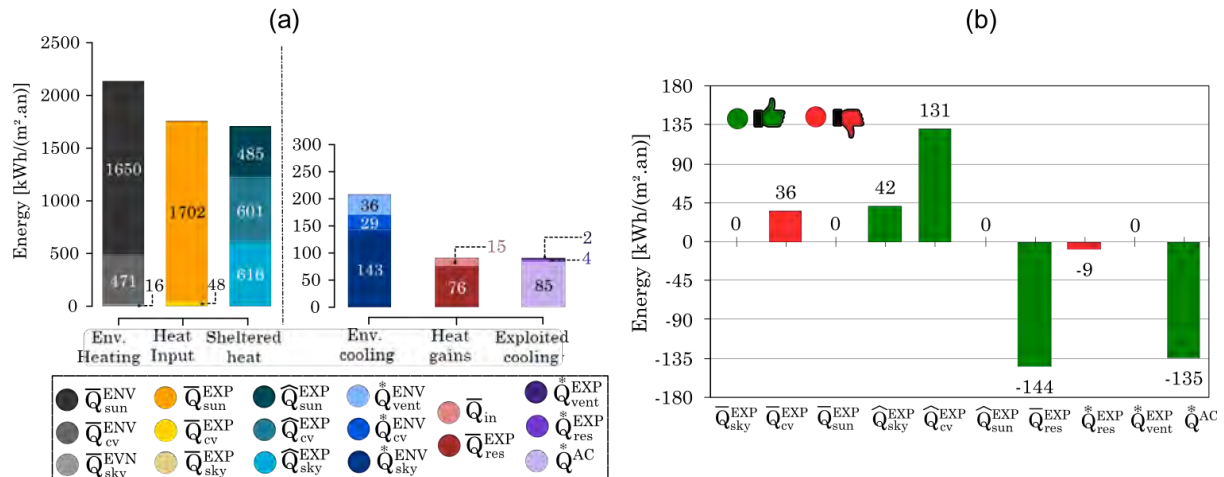

Figure 8 : Bioclimatic analysis of external insulation: (a) - Annual ERIs and BPIs for the solution; (b) - Change in indicators from the reference design.

the sum of the environmental cooling potentials ($\sum_i \hat{Q}_i^{ENV}$) is systematically higher than the sum of the heat inputs through the envelope (\bar{Q}_i^{EXP}). In principle, bioclimatic resources should globally be able to cover cooling demands if they could be properly exploited. However, these cooling potentials are less exploited by the insulated building than by the non-insulated one with an exploited rate τ^{EXP} of 2.3 %, for the sky and external convection resources which is 5 % lower than the reference (Table 4). Paradoxically, insulation, while increasing the bioclimatic margin, limits the environment cooling energy transfer through the envelope.

2.4. Bioclimatic analysis of the cool roof

The objective here is to reduce the solar heat input, and the graphs in Figure 9 show that the use of the cool roof reduces the solar sheltering potential \hat{Q}_{sun}^{EXP} by 262 kWh/m².yr, from 485 kWh/m².yr for the reference case to 223 kWh/m².yr for the studied model.

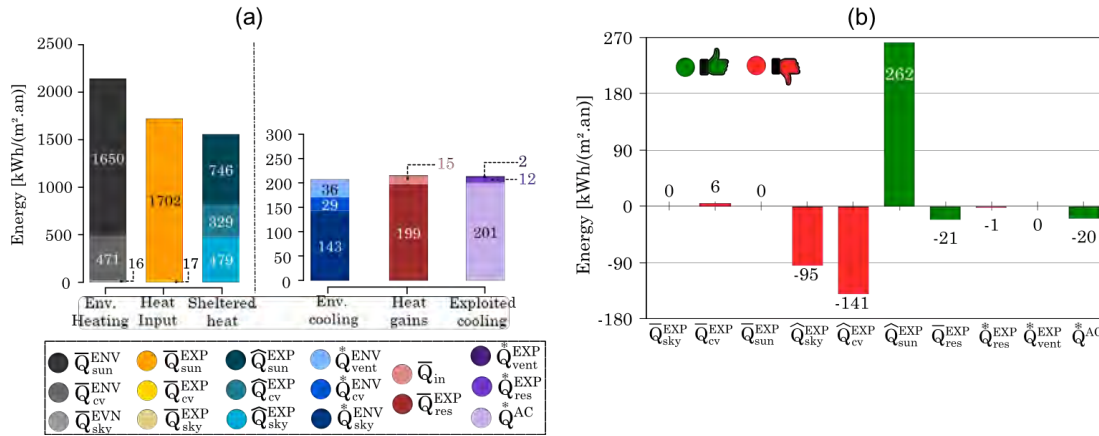

Figure 9 : Bioclimatic analysis of the cool roof: (a) - Annual ERIs and BPIs for the solution; (b) - Change in indicators from the reference design.

Table 5 : Values of the relative indicators for cool roof

Sky & external convection		Natural ventilation		sun	
τ^{EXP}	τ^{COV}	τ^{EXP}	τ^{COV}	τ^{SHE}	τ^{SHA}
6.8%	6.6%	4.4%	0.9%	90%	19.5%

However, another process interferes with this phenomenon and limits its positive impact on the envelope. Indeed, the high SRI index reduce the roof surface temperature. The surface absorbs less incident solar radiation and therefore remains cooler. This reduction in the temperature of the roof leads to an annual reduction in the sheltering potential \hat{Q}_{sky}^{EXP} and \hat{Q}_{cv}^{EXP} of 236 kWh/m².yr. Overall, the rather positive balance results in sheltering rate of $\tau^{SHE} = 90.4\%$ a small improvement of 1.2% compared to the reference. Thus, less heat loads are transmitted within the building (\hat{Q}_{res}^{EXP} of 21 kWh/m².yr less compared to the reference), which is cooling energy savings (120 kWh/m².yr less than the reference). Therefore, high reflection/emissivity coatings for roofing and on other facades are an overall improvement in building performance in hot climates. However, their durability is not guaranteed (they become dirty and dark due to dust, which reduces their reflective properties) and regular maintenance is recommended to maintain their effectiveness.

2.5. Bioclimatic analysis of the natural ventilation

The results in Figure 10 show more exploited natural ventilation potential (\hat{Q}_{vent}^{EXP}) compared to the initial reference (variation of 7 kWh/m².year of which more than two-thirds takes place at night).

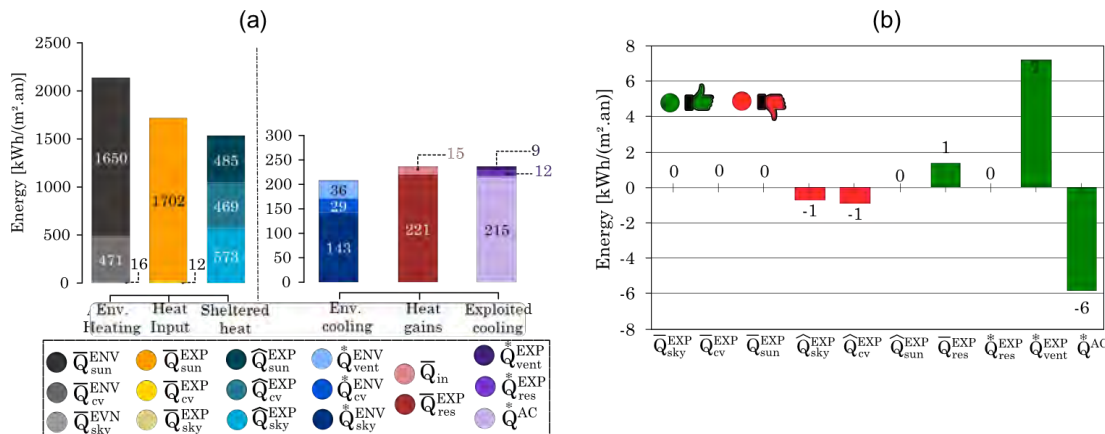

Figure 10: Bioclimatic analysis of the natural ventilation: (a) - Annual ERIs and BPIs for the solution; (b) - Change in indicators from the reference design.

Table 6 : Values of the relative indicators for natural ventilation

Sky & external convection		Natural ventilation		sun	
τ^{EXP}	τ^{COV}	τ^{EXP}	τ^{COV}	τ^{SHE}	τ^{SHA}
7.1%	6.1%	24.5%	4.5%	89.1%	19.8%

This results in a 20% improvement in the exploitation rate for natural ventilation compared to the reference. These additional exploited potentials cover more the exploited heat input potential (\overline{Q}_{res}^{EXP}) of the model. In fact, the exploited cooling from natural ventilation covers 4.5% of the internal heat loads through the envelope, 3,6% more than the initial case. Therefore, the overall increase in performance is only slightly higher than in the basic case.

CONCLUSION

In this paper the new sets of indicators developed by the authors were confronted with a study case. This confrontation showed that the information that can be drawn from the analysis of the indicators is valuable. They can orientate the choice of architects toward pertinent solutions in terms of bioclimatic architecture. The computation of the present indicators enrich the bioclimatic design by providing an overview of the exploitable resource and of the capacity of the building to exploit those resources. The tested solutions allow a decrease of the cooling needs potential in all cases. The most efficient technique from this point of view is external thermal insulation, which can reduce cooling by more than 60%. In fact, the energy saving is not mainly due to a better exploitation of the energy cooling potential, but to a reduction of the \overline{Q}_{res}^{EXP} . This is due to the protection of the envelope against available external heat input. Moreover, for the first time, we have highlighted two paradoxical requirements in terms of bioclimatic performance:

- ✓ Protect the building envelope to reduce environment heat input.
- ✓ Or increase the external surface exposure of the building to increase the sheltering potentials.

These results show, once again, the interest of an analysis of bioclimatic solutions using the developed indicators. If the tested techniques are efficient from the point of view of the classical criterion (i.e. they allow to reduce the air-conditioning needs), the analysis of the building performance indicators BPIs shows that there is still progress to be made in terms of sheltering potentials, bioclimatic margin improvement or exploitation of the cooling potentials.

REFERENCES

- Abdou, Idris Omar. 2020. « Études de l'amélioration de la performance énergétique et de stratégies de conception architecturale bioclimatique en climat chaud et humide ». Phdthesis, Université de Lyon. <https://tel.archives-ouvertes.fr/tel-03346755>.
- Aflaki, Ardalan, Norhayati Mahyuddin, Zakaria Al-Cheikh Mahmoud, et Mohamad Rizal Baharum. 2015. « A Review on Natural Ventilation Applications through Building Façade Components and Ventilation Openings in Tropical Climates ». *Energy and Buildings* 101 (août): 153-62. <https://doi.org/10.1016/j.enbuild.2015.04.033>.
- Butera, Federico, Rajendra Adhikari, et Niccolò Aste. 2014. *Sustainable Building Design for Tropical Climates: Principles and Applications for Eastern Africa*. UN-Habitat.
- Centeno, Melchor. 1982. « New Formulae for the Equivalent Night Sky Emissivity ». *Solar Energy* 28 (6): 489-98. [https://doi.org/10.1016/0038-092X\(82\)90320-6](https://doi.org/10.1016/0038-092X(82)90320-6).
- Ciampi, M., F. Leccese, et G. Tuoni. 2003. « Ventilated facades energy performance in summer cooling of buildings ». *Solar Energy* 75 (6): 491-502. <https://doi.org/10.1016/j.solener.2003.09.010>.
- Clark, Gene, et Chester Allen. 1978. « The estimation of atmospheric radiation for clear and cloudy skies ». In *Proc. 2nd National Passive Solar Conference (AS/ISES)*, 675-78.
- Draoui, B., B. Mebarki, S. Abdessemed, A. Keboucha, S. Drici, et A. Sahli. 2015. « Etude d'un système de climatisation intégrant un puits canadien dans les zones arides, cas de Béchar, cder ».
- Edmonds, I.R., et P.J. Greenup. 2002. « Daylighting in the tropics ». *Solar Energy* 73 (2): 111-21.
- Givoni, B. 1991. « Impact of planted areas on urban environmental quality: A review ». *Atmospheric Environment. Part B, Urban Atmosphere* 25 (3): 289-99. [https://doi.org/10.1016/0957-1272\(91\)90001-U](https://doi.org/10.1016/0957-1272(91)90001-U).
- Givoni, Baruch. 1994. *Passive Low Energy Cooling of Buildings*. John Wiley & Sons.
- Granqvist, C.G., S. Green, G.A. Niklasson, N.R. Mlyuka, S. von Kræmer, et P. Georén. 2010. « Advances in Chromogenic Materials and Devices ». *Thin Solid Films* 518 (11): 3046-53. <https://doi.org/10.1016/j.tsf.2009.08.058>.
- Hamza, Neveen. 2008. « Double versus Single Skin Facades in Hot Arid Areas ». *Energy and Buildings* 40 (3): 240-48. <https://doi.org/10.1016/j.enbuild.2007.02.025>.
- Idris, Abdou, Damien David, Etienne Vergnault, Joseph Virgone, et Abdoukader Ibrahim Idriss. 2020. « A New Set of Indicators to Evaluate the Bioclimatic Performance of Air Conditioned Buildings in a Hot and Humid Climate ». *Journal of Building Engineering* 31 (mars): 101350. <https://doi.org/10.1016/j.job.2020.101350>.
- Liu, Kyle, et Bas Baskaran. 2003. « Thermal performance of green roofs through field evaluation ». *Proceedings for the First North American Green Roof Infrastructure Conference, Awards, and Trade Show*, janvier.
- Lorenz, W. 2001. « A glazing unit for solar control, daylighting and energy conservation ». *Solar Energy* 70 (2): 109-30. [https://doi.org/10.1016/S0038-092X\(00\)00132-8](https://doi.org/10.1016/S0038-092X(00)00132-8).
- Mazria, Edward. 1979. *The Passive Solar Energy Book*. Rodale Press.
- Omar, Abdou Idris, Joseph Virgone, Etienne Vergnault, Damien David, et Abdoukader Ibrahim Idriss. 2017. « Energy Saving Potential with a Double-Skin Roof Ventilated by Natural Convection in Djibouti ». *Energy Procedia* 140 (décembre): 361-73.
- Peel, M. C., B. L. Finlayson, et T. A. McMahon. 2007. « Updated World Map of the Köppen-Geiger Climate Classification ». *Hydrology and Earth System Sciences* 11(5):1633-44. <https://doi.org/10.5194/hess-11-1633-2007>.
- Raeissi, S., et M. Taheri. 2000. « Skytherm: an approach to year-round thermal energy sufficient houses ». *Renewable Energy* 19 (4): 527-43. [https://doi.org/10.1016/S0960-1481\(99\)00079-8](https://doi.org/10.1016/S0960-1481(99)00079-8).
- Reppel, J., et I. R Edmonds. 1998. « Angle-selective glazing for radiant heat control in buildings: theory ». *Solar Energy* 62 (3): 245-53. [https://doi.org/10.1016/S0038-092X\(98\)00006-1](https://doi.org/10.1016/S0038-092X(98)00006-1).
- Saadatian, Omidreza, Lim Chin Haw, K. Sopian, et M. Y. Sulaiman. 2012. « Review of windcatcher technologies ». *Renewable and Sustainable Energy Reviews* 16 (3): 1477-95. <https://doi.org/10.1016/j.rser.2011.11.037>.
- Santamouris, M., et D. Asimakopoulos. 1996. *Passive Cooling of Buildings*. James & James.
- Smith, G.B., S. Dligatch, et F. Jahan. 1998. « Angular selective thin film glazing ». *Renewable Energy* 15 (1-4): 183-88.
- Yannas, Simos, Evyatar Erell, et Jose Luis Molina. 2006. *Roof Cooling Techniques: A Design Handbook*. Earthscan.
- Yu, Chen, et Wong Nyuk Hien. 2006. « Thermal benefits of city parks ». *Energy and Buildings* 38 (2): 105-20.

Informing Early-Stage Building Energy Retrofit for Prototypical Public Schools in Chile

Andrea Martínez Arias¹, María Isabel Rivera Barraza^{1,2}, Pablo Arriagada Ojeda¹

¹Facultad de Arquitectura, Urbanismo y Geografía, Universidad de Concepción, CHILE

²Researcher, Centre for Sustainable Urban Development (CEDEUS), CHILE

ABSTRACT: Climate change has local manifestations through extreme weather events, such as drought and heatwaves. While those extreme conditions can be mitigated in new buildings through improved designs and new construction codes, assessing existing buildings can be challenging. Existing buildings have been operative for many years, some built before energy codes, and many have reached their useful life with little or no maintenance. This study explores a workflow for assessing the improvement of existing public schools in Chile. Although public schools run with very little energy consumption, retrofitting those buildings represents an opportunity to achieve net-zero emissions while improving indoor comfort. A public school in the central-southern region of Chile is used as a case study. It features prefabricated metal frames with masonry infill in exterior walls, single glass panes, and no insulation on walls or roofs, with substantial evidence of thermal bridging. These types of schools are not equipped with active systems for conditioning, and therefore, it is still a predominant typology in the country built in the 1960s, which has low actual energy consumption and is therefore energy-efficient. However, that energy efficiency is a tradeoff in the indoor comfort of students and teachers. Retrofit alternatives were evaluated based on an energy model using software for early design stages. The model had an error margin of less than 5% than the school's actual energy consumption. Several improvement strategies on the thermal envelope are proven as potential effective retrofits. Net-zero emissions is visualized as likely considering the already low energy consumption of the building. This study is informative to many similar schools that are still operational long after having completed their useful lives with little maintenance. Finally, the study contributes a quick and easy alternative that designers could use to improve our extensive stock of existing buildings.

KEYWORDS: Existing Schools, Energy Retrofit, Calibration Models, Passive Design, Global Sustainability: Mitigation and Adaptation, Digital Design and Practices.

INTRODUCTION

Schools are a critical building type since they provide shelter to our children during their early years, and still, in Chile, there is no policy for schools to comply with high performance. Neither energy codes nor special certifications at a national level mandate schools to comply with high-environmental standards. Most of the existing schools were built with little consideration of energy and indoor environmental performances, and many are still operational despite having completed their useful lives. A few rules from the 1980s regulate a limited set of indoor parameters, such as the minimum temperature in classrooms, 12°C (53.6°F), or the minimum lighting levels in classrooms, 180 lux (Ministerio de Educación 1989). The norm also mentions that artificial light and mechanical ventilation can supply underlit and underventilated spaces. Mechanical ventilation should be provided whenever natural ventilation is impossible with existing fenestrations, which is rare in Chilean schools due to energy costs and restricted budgets in public schools. Still, some schools use wood furnaces inside the classrooms for heating in cold climates.

In the last years, the government has improved the standards for new schools. Along with reforms to education that started in 1997, the government recommends a series of sustainable criteria whenever new school facilities are built with public funding. The so-called "seal schools" (in Spanish "escuelas sello") are to be certified by a national system of sustainability. In the process, the government has assumed the global challenge that all new and improved existing buildings follow high standards of sustainability, comfort, and energy efficiency (Ministerio de Educación 2013, 30). However, these new schools are still a tiny portion of the country's extensive stock of schools, many of which are still operative long beyond their useful lives and urgently need renovation. More than 9,000 primary schools provide learning shelter for nearly 2 million children in the country (Ministerio de Educación 2018). The government started the first survey of school facilities in 2012 after the 8.8 magnitude earthquake suffered in 2010, collecting information from 5,530 school facilities (Ministerio de Educación 2020). School facilities have a wide range of ages and sizes and have different levels of damage. Fifty-six percent of the school buildings presented less than 20% damage; 34% of the buildings had between 20% and less than 40% damage; and about 10% of these surveyed buildings presented damage equal or superior to 40% (Montenegro 2016). Even though the school inventory was a monumental task, it still does not provide a precise diagnostic of the spatial and comfort conditions of the stock of schools.

On a global level, poor comfort conditions negatively affect students' performance, increase respiratory diseases and absenteeism, and high teacher turnover. Students learn in precarious conditions, and those are mostly the more vulnerable kids. The different environmental factors affecting children's health and learning in classroom settings have been widely reported in the existing literature. Improved acoustical, air quality, and thermal conditions are essential in schools (Bluyssen et al., 2018). Several studies have found a school with poor air quality—high levels of CO₂ concentration particulate matter or volatile organic compounds (Madureira et al. 2016, Krawczyk et al. 2016, Shendell et al. 2004). It is urgent to reduce children's exposure to the polluted environment to bring benefits in learning (Bakó-Biró et al. 2012) while reducing disease, mortality and improving wellbeing, especially for kids (World Health Organization 2018). Also, daylighting is a fundamental indoor condition, and windows are critical in student performance and learning (Heschong Mahone Group 2003, 119). Considering the individual differences in the perception of comfort in kids (Teli, Jentsch, and James 2014), the importance of indoor environmental conditions keeps being proven as fundamental, as is the perception of comfort from the users of these learning spaces (De Giuli, Da Pos, and De Carli 2012).

In Chile, spatial and indoor conditions for learning and comfort are not always achieved in schools, whether public or private (Trebilcock, Bobadilla, et al. 2012, Trebilcock et al. 2016, Armijo, Whitman, and Casals 2011). Indoor environmental conditions such as noise, reduced lighting levels, and overheating are typical considering overcrowded classrooms. Temperatures lower than 8°C have been registered in the winter season while concentrations of CO₂ are higher than 3,800 ppm (Montenegro 2016). In terms of thermal comfort in schools, combustion heating artifacts are still common in cold areas, schools in warmer areas, and no cooling systems. Artificial lighting is frequent due to insufficient natural daylighting, high contrast and glare, and uneven distribution. Consequently, what leads to artificial lighting are usually outdated or non-efficient fixtures. Finally, with around 1.1 m²/student, Chilean schools are among the most crowded compared to the 2 m²/student of OECD countries (Montenegro 2016). Too many children in the classroom is only one factor in schools registering CO₂ over 5,000ppm in classrooms in Chile (Rivera 2019). In addition, projectors introduced into the classroom derived from teachers keeping curtains closed, which also difficult ventilation from windows. With too many kids in a classroom, the spread of illnesses like SARS-CoV2 and the resulting absenteeism, high noise levels, and the low performance of students and teachers are always present risks.

With new standards and guidelines for healthy and high-performance schools being helpful resources in improving schools, there is still a long way to implement the existing ones. New standards and certifications have established parameters for proper ventilation and air quality, thermal comfort, acoustics, and various fundamental attributes in high-performance schools (ASHRAE 2018), and many leading international certifications include unique systems for schools. In Chile, some critical initiatives have focused on providing recommendations for the energy efficiency of schools (Trebilcock, Piderit, et al. 2012) and colleges (Marimón and Morell 2014). However, still more guidelines are needed to inform school stakeholders. Improvements such as replacing combustion systems to air conditioning equipment or replacing old light fixtures are standard partial retrofits in schools; however, these do not solve the problem. Those interventions might increase energy bills even when they are probably undersized to overcome the envelope deficiencies. These "low-hanging fruit" solutions do not adequately solve the problem.

Retrofitted schools are called to restore health, performance, environmental, and cost considerations together in a life-cycle perspective, maximizing wellbeing while minimizing ecological impacts. The initial investment of a whole-building retrofit may seem expensive. Still, from a whole-building lifespan perspective, that added cost could pay for itself due to decreased energy cost and future earnings from the yields of students' and teachers' improved wellbeing. High-performance schools have proved that increased value resulted in annual financial benefits by more than 15-fold, the most important of the estimated future gains for improved academic performance (Kats G, Perlman J, and S. 2005). Even if a complete retrofit could not be possible as one investment, a plan containing the right-step retrofit process should be provided.

Energy simulations made by experts can be prohibitive for most school districts and also a time-consuming process. While they are less accurate, user-friendly tools, such as plugins to the leading design software, would allow for early analysis using simple mass studies with few inputs. Those easy-to-use tools are handy to know performance displays while designing. But most important, to efficiently assess school improvement, easing early-stage analysis is fundamental to inform the decision-making process.

1.0 METHODOLOGY

1.1 Objectives

The objective of this study was to evaluate retrofit strategies in the early stages of the assessment process. For doing so, the following specific objectives were set:

- Identifying early-stages plugins would be more efficient for representing the actual energy use of existing buildings.
- Determining the error range of these models.
- Evaluating the flexibility for assessing retrofit strategies.

1.2. Methods

This study used the following methods and steps:

- Model a case study school in a commonly used modeling software for geometry (Sketchup – Revit). The study considered SketchUp (Trimble, 2021) a user-friendly software plugin to evaluate its capabilities for generating fast outputs during the early design, using EnergyPlus and Radiance engines for calculations. For the energy study, the Sefaira Plugin (Trimble, 2021) was used in conjunction with both models.
- Compare the simulated results to existing consumption for a year. A pre-pandemic year was used for the study since it represented a typical use in the school.
- Estimate the potential for energy generation to achieve net-zero energy condition.

1.3. Case Study

A public school building located in a valley city in the central-south region in Chile was used as a case study. The building represents a prototypical prefabricated school building constructed by the government to palliate schools' deficit in an educational reform implemented in the middle of the 20th century. The school, built in 1968, accounts for 2,400 m² on a site of 10,000 m². The school is administered by the municipality department responsible for the operation and maintenance of the school. The school has 420 students; however, the current enrollment is around 377 students from pre-school to 8th-grade, corresponding to the primary-cycle in the morning and afternoon uses. On average, classrooms have an occupancy of 20 students (DAEM, 2021). Figure 1 provides general view of the outside patio and corridors of the school.



Figure 1: Location Los Angeles, Chile (left). Image of exterior of the school (top right) and one of the corridors reaching the classroom pavilion (bottom right). Source: (Authors, 2021)

The school belongs to a typology resulting from a government plan for increasing literacy and instruction as public policy in the middle of the 20th century. The so-called Society for Construction of Educational Facilities (in Spanish Sociedad Constructora de Establecimientos Educacionales - SCEE) was created primarily to build schools in the whole country. This entity was responsible for constructing schools from 1937 until 1987 (Valdivia y Torres, 2016). Mass production of schools from that period contributed to building a stock strongly in quantity but not in space quality.

Looking at the energy use, the school has a very low energy use. Actual electricity use during the 2019 school year was 29,900 kWh/year as illustrated by monthly consumption in Figure 2. Based on the 2,463 m² of usable area, the school had a resulting Energy Use Intensity (EUI) of 12.45 kWh/m²/year. Energy consumption in this school is low mainly because it does not have conditioning systems for heating, ventilation, or cooling (HVAC). The school is heated by burning wood, including in classrooms, while cooling occurs mainly through natural ventilation. Therefore, this electricity consumption represents end uses such as lighting and plug loads.

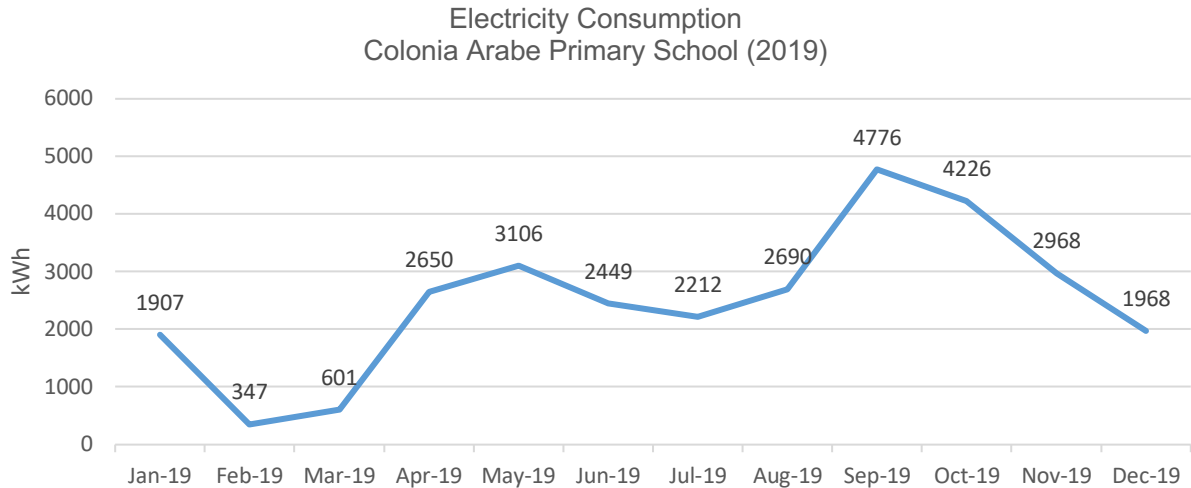

Figure 2: Electricity consumption by the case-study school for the year 2019. Source: (Authors, 2021)

The school's physical deficiencies represent a historical debt to this community. Figure 3 shows some thermal images of classrooms of thermal bridging in winter time (with wood stove on) and summer time heat transfer through the roof steel beams. The lower energy consumption is a tradeoff for comfort, evidenced by plans of demolition and parent strikes. In 2018, this school was listed for demolition, and in 2018 a national competition was opened for a new building (La Tribuna, 2018). However, the new building has been on hold during the COVID pandemic. Also, a peaceful strike was embraced by parents to protest the poor conditions, primarily due to deficiencies in bathroom facilities (El Contraste, 2019).

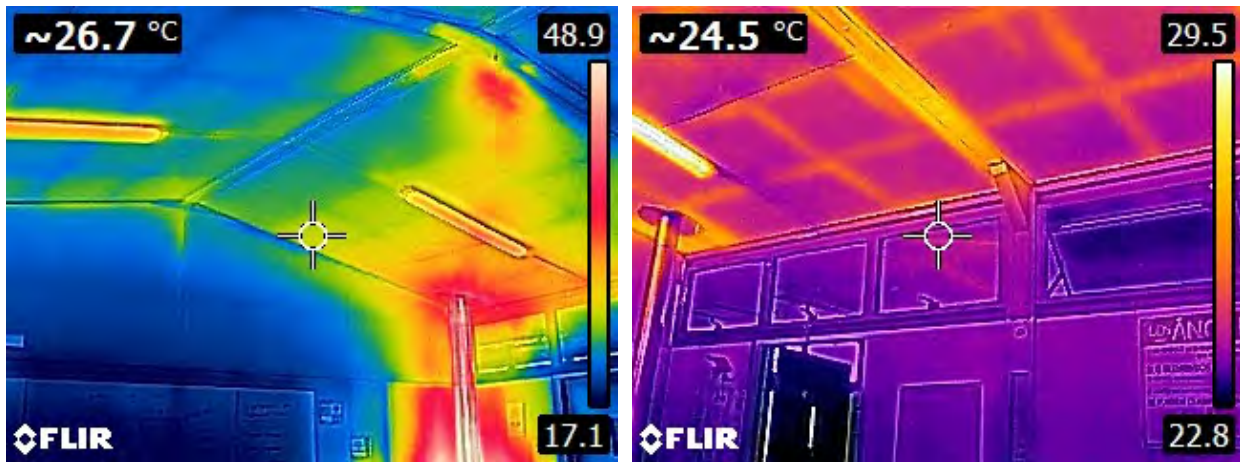

Figure 3: Thermal imaging of classrooms showing thermal bridges in roof areas during winter (left) and summer (right)

2.0 MODELS AND CALIBRATION

2.1. Analytic Model

As a first step, a geometry model was built in SketchUp (Trimble, 2021) and Revit, using little effort due to the lack of details. The Sefaira plugin automatically identifies envelope components such as roof, walls, windows, and floors, saving time on input parameters, as shown in Figure 3. The rapid feedback of energy performance is displayed through a dashboard displayed by the plugin.

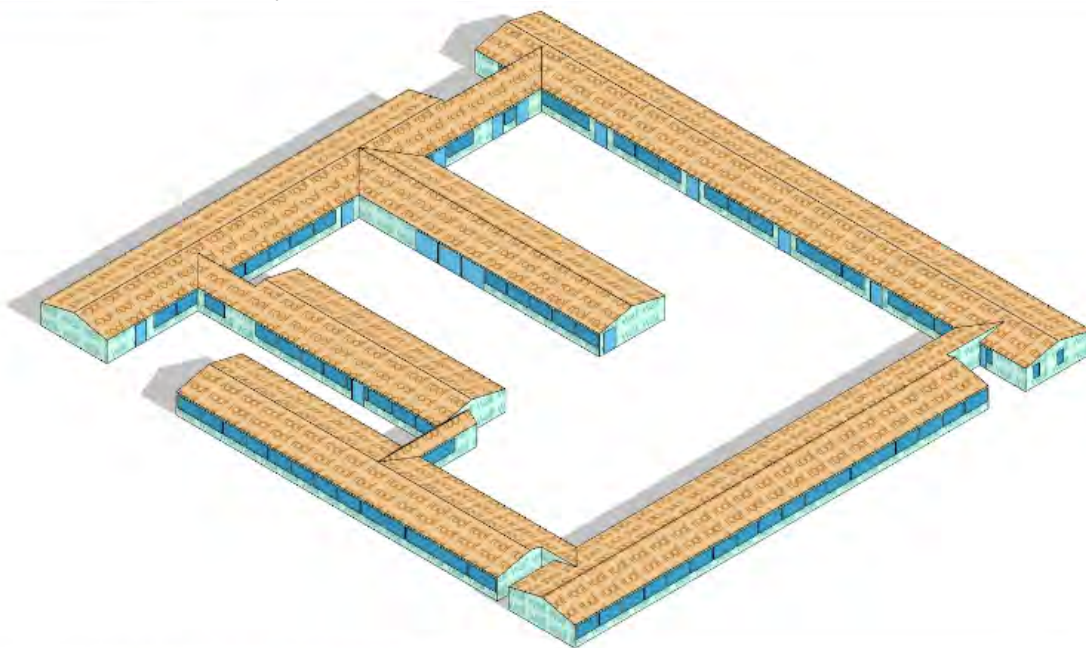

Figure 4: Image of geometry SketchUp model showing the roof, wall, and window components. Source: (Authors, 2021)

2.2. Input parameters

The geometry was obtained by modeling in Sketchup and Revit, and location and orientation were defined in the model. The Sefaira plugin allows for two levels of input/outputs with an increasing number of instances. The first set of inputs was defined considering the most sensitive parameters by the plugin, which are listed in Table 1. Those inputs allowed for a first baseline. However, the plugin assumes mechanical systems, which did not match the actual free-running school condition.

Table 1: Input at the screen plugin parameters for the baseline model. Source: (Authors) based on the Sefaira Plugin inputs.

Variable	Condition
Wall insulation	No insulation
Floor insulation	No insulation
Roof insulation	No insulation
Glazing U-Factor	1 Pane
Visible light transmittance	1 Pane
Solar heat gain coefficient	Clear single glazing
Infiltration rate	Leaky building
Ventilation rate	High ventilation
Equipment	Poor
Lighting	Poor

A final baseline was determined with a second level of inputs was defined on the cloud interphase, with an extended detail for envelope components, as shown in Table 2. The cloud fields allowed modifying performance parameters such as thermal conduction (μ) values. Also, inputs for internal loads such as occupancy, equipment, and lighting loads were defined on actual estimates from the school. Only at the cloud interphase was it possible to eliminate HVAC, which allowed to get closer to the free-running school condition. All these configurations produced changes in final consumption, resulting in energy use of 12.78 kWh/m²/year.

Table 2: Final input parameters for the baseline model. Source: Authors

Energy	Material	Unit	Value
Façade Glazing	Glass	W/m ² ·K	4.8
Walls	Brick	W/ m ² ·K	2.27
Floors	Tiles	W/ m ² ·K	0.70
Infiltration	Crack Infiltration	L/s-m	2.00
Roof glazing	Glass	W/ m ² ·K	0.40
Roofs	Metal Deck	W/ m ² ·K	1.90
Occupant density	-	m ² /person	7.0
Equipment power density	-	W/ m ²	3
Lighting power density	-	W/ m ²	3
EUI TOTAL			12.78 kWh/m²/year

3.0 RESULTS

3.1. Baseline model

With the EUI of 12.78 kWh/m²/yr, allowing results with a difference of 2.58% compared to the consumption shown in Table 3, it is possible to see all the configurations used, established for the purposes of the investigation as the Baseline. From this point, the exploration of optimizations began to reduce energy consumption.

Table 3: Final annual energy consumption by energy bills and Sefaira baseline model. Source: (Authors)

	EUI	Unit
<i>Actual electricity use</i>	12.45	kWh/m ² /year
<i>Model electricity use</i>	12.78	kWh/m ² /year
<i>Difference</i>	2.58%	

3.2. Retrofit strategies

Since the deficiencies known in the building were mainly in the envelope, the strategies focused on improving the thermal performance of the roof, walls, and glazing. It also contemplated improvement for lighting. Two rounds of retrofits were run. Input values for those changes are identified in Table 4.

Table 4: Final inputs for alternatives for retrofits.

Energy	Material	Unit	Baseline	Retrofit strategies #1	Retrofit strategies #2
<i>Façade Glazing</i>	<i>Glass</i>	W/m ² ·K	4.8	2.9	1.4
<i>Walls</i>	<i>Brick</i>	W/ m ² ·K	2.27	0.33	0.4
<i>Floors</i>	<i>Tiles</i>	W/ m ² ·K	0.70		
<i>Infiltration</i>	<i>Crack Infiltration</i>	L/s-m	2.00		
<i>Roof glazing</i>	<i>Glass</i>	W/ m ² ·K	0.40		
<i>Roofs</i>	<i>Metal Deck</i>	W/ m ² ·K	1.90	1	1
<i>Occupant density</i>	-	m ² /person	7.0		
<i>EPD</i>	-	W/ m ²	3		
<i>LPD</i>	-	W/ m ²	3	2	2
	EUI TOTAL	kWh/m²/year	12.78	9.21	9.18
				-27.94%	-28.17%

The first set of retrofit strategies (Retrofit Strategies #1), resulting in a final EUI of 9.21 kWh/m²/year:

- Firstly, replacing the school's windows from simple to insulated glass with better thermal resistance.
- Complementary, large windows throughout the school, the window-to-wall ratio was reduced, dropping from 40% to 20% on west façades.
- Likewise, opaque walls were improved by applying an exterior insulation system layer, EIFS, composed of expanded polystyrene and a rough coating, reducing thermal losses.
- The roof's insulation was improved by applying a ceiling and adding insulation.
- Finally, reducing energy consumption was postulated by changing the lighting, which are currently fluorescent tubes, to LED panels, reducing the Light Power Density to 2 W/m².

The second round of retrofit (Retrofit Strategies #2) looked to fine-tune on two specific instances of the envelope, resulting in a final EUI of 9.18 kWh/m²/year:

- It began with the variation of the composition of the glass on the façade, going from simple glass to insulated Low-E glass, from μ value of 4.8 W/m²·K to 1.4 W/m²·K.
- As the construction of this typology of schools is modular, within this modification, the possibility of replacing the composition of the walls was raised, replacing bricks with cement blocks, improving the μ -value of the brick wall from 2.27 W/m²·K to 0.4 W/m²·K.
- Reducing the window-to-wall ratio for the South and West façade from 50% to 40% and 20%, respectively.
- Like the previous set of retrofit strategies, the same improvement for the ceiling integrated an insulated false ceiling, reducing the value of the roof to 1 W/m²·K.
- Finally, reducing energy consumption was sought by changing the lighting, lowering the Light Power Density to 2 W/m².

4.0 DISCUSSION

The software tools were easy to use in the early stage of decision making. Overall, it was helpful in informing energy and daylighting performance, which in the case study, it did not refer to massing exploration, but changes on the building envelope through the definition of input parameters. However, it had some limitations when applied to the case study. The tool does not allow for elimination of HVAC in the plugin. The free-run condition was not represented in the plugin interphase but in the cloud interphase.

The actual EUI of 12.45 kWh/m²/year is shallow consumption for school buildings. This is especially true compared to schools that use active systems, such as in developed countries like the USA. Although there was a lower energy consumption at the end of the analyzed year, this energy consumption is still low because of the lack of conditioning systems in the building. Regarding energy savings, retrofits resulted in 27.94% and 28.17% reduction from retrofit #1 and #2, respectively. Although those are considerable savings, the extra effort from the second set of strategies might be marginal compared to the effort of those strategies. Nevertheless, a building with this energy consumption can be easily transformed into a net-zero energy building by implementing on-site energy generation. However, it does not solve the problem of energy conservation and the need for improved indoor comfort.

When comparing both optimizations carried out, there is no significant difference between one and the other; however, in the case of the first retrofit set, a change was sought in the construction elements that would have a lower cost than the second retrofit set. In the case of the second optimization, it was sought to reduce energy consumption by applying higher value construction elements. This improved the existing brick wall by applying a complement layer type EIFS.

Although this study covered strategies to reduce energy use, the final goal of the represented retrofit strategies would be for superior benefits: better indoor environment quality for learning. Considering that there is a debt on the public school system to minimum comfort, there must be a more robust effort to improve existing buildings. It is urgent to establish energy codes that could push for improvements that ensure, at least, a minimum level of comfort conditions for many kids and teachers that spend most of their day in these types of schools.

CONCLUSION

This study explored early-stage estimations of retrofits through commonly used software tools for early-stage designs. It showed that quick estimations can be made considering total energy use. With current plugins, retrofits are quickly estimated for sensitive input parameters. In the case study, a public school in the central-southern region in Chile, improvements resulted in energy reductions close to 30%. Although the case study has a low actual energy use, it is poorly built and has no active systems for indoor conditioning. While it is good from an energy perspective, unfortunately, the case study is representative of a large portion of schools in the country where energy efficiency is a tradeoff of children and teachers' comfort.

This research line is informative and does not hope to be an alternative to comprehensive energy calibrated models and parametric optimization analyses. This study covered the line of easy and quick first explorations that might be useful for early-stage retrofits assessments in the design process. Hopefully, this is a practice that starts to be more common, as we need to urgently assess our existing stock of buildings for both climate commitment and human commitments.

ACKNOWLEDGEMENTS

This study was possible thanks to the support provided by the following people/institutions: Faculty of Architecture, Urbanism and Geography (FAUG) of the University of Concepción; government-funded research by ANID PAI-77180057 and CEDEUS, ANID/FONDAP 15110020.

REFERENCES

- Armijo, G., C.J. Whitman, and R. Casals. 2011. "Post-occupancy evaluation of state schools in 5 climatic zones of Chile." *Gazi University Journal of Science* no. 24 (2):265-374.
- ASHRAE. 2018. *Advanced Energy Design Guide for K-12 School Buildings - Achieving Zero Energy*. Atlanta, GA: ASHRAE
- Bakó-Biró, Zs, D. J. Clements-Croome, N. Kochhar, H. B. Awbi, and M. J. Williams. 2012. "Ventilation rates in schools and pupils' performance." *Building and Environment* no. 48:215-223. doi: <https://doi.org/10.1016/j.buildenv.2011.08.018>.
- Bluyssen, Philomena M. , Dadi Zhang, Stanley Kurvers, Marjolein Overtoom, and Marco Ortiz-Sanchez. 2018. "Self-reported health and comfort of school children in 54 classrooms of 21 Dutch school buildings." *Building and Environment* no. 138 (2018):106-123.
- De Giuli, Valeria, Osvaldo Da Pos, and Michele De Carli. 2012. "Indoor environmental quality and pupil perception in Italian primary schools." *Building and Environment* no. 56:335-345. doi: <https://doi.org/10.1016/j.buildenv.2012.03.024>.
- Heschong Mahone Group. 2003. *Windows and Classrooms: A Study of Student Performance and the Indoor Environment*. California Energy Commission.
- Kats G, Perlman J, and Jamadagni S. 2005. *National review of green schools: costs, benefits, and implications for Massachusetts*. Original edition, Washington, DC.
- Krawczyk, D. A., A. Rodero, K. Gładyszewska-Fiedoruk, and A. Gajewski. 2016. "CO2 concentration in naturally ventilated classrooms located in different climates—Measurements and simulations." *Energy and Buildings* no. 129:491-498. doi: <https://doi.org/10.1016/j.enbuild.2016.08.003>.
- La Tribuna. (2018). *Escuela Colonia Árabe cada vez más cerca de contar con nueva infraestructura*. *Diario La Tribuna*. Recuperado de <https://www.latribuna.cl/noticias/2018/07/05/escuela-colonia-arabe-cada-vez-mas-cerca-de-contar-con-nueva-infraestructura.html>
- Madureira, Joana, Inês Paciência, João Rufo, Milton Severo, Elisabete Ramos, Henrique Barros, and Eduardo de Oliveira Fernandes. 2016. "Source apportionment of CO2, PM10 and VOCs levels and health risk assessment in naturally ventilated primary schools in Porto, Portugal." *Building and Environment* no. 96:198-205. doi: <https://doi.org/10.1016/j.buildenv.2015.11.031>.
- Marimón, Vanesa, and Alejandro Morell. 2014. *Guía de apoyo al desarrollo de diagnósticos energéticos para instituciones de educación superior IES*.
- Ministerio de Educacion. 1989. Decreto 548.
- Ministerio de Educacion. 2013. *Criterios de diseño para espacios educativos*.
- Ministerio de Educacion. 2018. *Estadísticas de la Educación 2017*. Santiago, Chile: Centro de Estudios MINEDUC.
- Ministerio de Educación. 2021. *Catastro de Infraestructura Escolar 2020* [cited 2021 april 1 2021]. Available from <https://infraestructuraescolar.mineduc.cl/estudios-y-publicaciones/catastro-infraestructura-escolar/>.
- Montenegro, Esteban. 2016. *Buena Arquitectura, Mejor Educacion CA Ciudad y Arquitectura*, 2016.
- Shendell, DG, R Prill, WJ Fisk, MG Apte, D Blake, and D. Faulkner. 2004. "Associations between classroom CO2 concentrations and student attendance in Washington and Idaho. ." *Indoor Air*. 2004 no. Oct;14(5) 333-41. doi: 10.1111/j.1600-0668.2004.00251.x. PMID: 15330793.
- Teli, Despoina, Mark F. Jentsch, and Patrick A. B. James. 2014. "The role of a building's thermal properties on pupils' thermal comfort in junior school classrooms as determined in field studies." *Building and Environment* no. 82:640-654. doi: <https://doi.org/10.1016/j.buildenv.2014.10.005>.
- Trebilcock, M., A. Bobadilla, B. Piderit, R. Figueroa, C. Muñoz, R. Sanchez, and J. Hernández. 2012. *Environmental Performance of Schools in Areas of Cultural Sensitivity*, . In PLEA 2012, 28th Conference, Opportunities, Limits & Needs Towards an environmentally responsible architecture. Lima, Perú.
- Trebilcock, M., J. Soto-Muñoz, M. Yañez, and R. Figueroa-San Martin. 2016. "The right to comfort: A field study on adaptive thermal comfort in free-running primary schools in Chile. ." *Building and Environment* no. 114:455-469. doi: <http://doi.org/10.1016/j.buildenv.2016.12.036>.
- Trebilcock, Maureen, María Piderit, Muriel Diaz, Freddy Guzmán, Ariel Bobadilla, Rodrigo Figueroa, Cristian Muñoz, Roberto Arriagada, Daniela Besser, and Tobias Hatt. 2012. *Guía de Eficiencia Energética de Establecimientos Educativos*. Agencia Chilena de Eficiencia Energética.
- Trimble (2021). Sketchup.
- World Health Organization. 2018. *Air Pollution and Child Health, Prescribing clean air*.
- Valdivia, S; Torres, C. (2016). *Infraestructura escolar pública. Historia, patrimonio y deuda*. *Revista Ciudad y Arquitectura*. Accessed from <http://revistaca.cl/portada-revista-ca-153/articulos-portada/articulo-02-soledad-valdivia/>

An Air-Depolluting System for Indoor VOC Reduction

Ketki Prashant Bapat¹, Ok-Kyun Im¹, Chengde Wu², Kyoung-Hee Kim¹,

¹University of North Carolina at Charlotte, Charlotte, NC

²Iowa State University, Ames, IA

ABSTRACT: Volatile Organic Compounds (VOCs) are one of the pollutants that impact indoor air quality, leading to many adverse health effects such as Asthma, and other breathing issues. Most of the VOCs are harmful and carcinogenic, usually emitted by indoor sources like disinfectants, insecticides, and building materials including wall paint, varnishes, and many more. As human beings spend 90% of their time indoors, it is necessary to maintain good indoor air quality by reducing harmful VOCs. Photocatalysis is one way to remove the VOCs in which catalytic compounds activate in presence of sunlight to initiate a chemical process that breaks down VOCs in the air. In this case, a photocatalytic compound TiO_2 is activated in presence of UV light and breaks down VOCs in the air. The more the surface area is covered with TiO_2 and in contact with sunlight, the more effective it removes VOCs. A building facade is one of the building elements that are in direct contact with sunlight and interior space. Therefore, it can serve as a prime location to implement TiO_2 photocatalytic facade and remove VOCs. The facade configuration studied in this paper was chosen as a tetrahedron geometry to increase more surface area for coating TiO_2 under a unit volume. Experiments were carried out to study the effect of TiO_2 coated facades in reducing VOCs, the source of which was generated by hand sanitizer and silicone sealant. Two TiO_2 coated facades were tested: one is with TiO_2 powder and the other with TiO_2 spray. The experiment result indicated that a significant amount of formaldehyde was reduced with the use of both powdered and sprayed TiO_2 facades. It was observed that sprayed TiO_2 was more effective in reducing formaldehyde compared to powdered TiO_2 . Varying levels of UV intensity from the sunlight were still effective in reducing formaldehyde.

KEYWORDS: Air Depolluting Facade, Indoor air quality, Photocatalysis, TiO_2 , Volatile Organic Compounds (VOCs)

INTRODUCTION

There are many air-polluting elements that are harmful to the environment as well as humans including particulate matter, ozone, Volatile Organic Compounds (VOCs), and many more. These harmful gases and matter cause many health issues in human beings. The scope of this paper is to reduce the VOCs present in the air using a photocatalytic facade system. According to the EPA, it is estimated that humans spend 90% of their time indoors where the concentration of VOCs is 10 times higher than the concentration outdoors because of limited sources of natural ventilation indoors (Wallace 1989). Building materials like paints and other solvents, wood products, furnishings, carpets are some of the major sources of VOCs in the interior. Disinfectants, aerosol spray, pesticides, adhesives, and glues are a few other sources of VOCs.

VOCs are pollutants that cause different impacts on humans and the environment. They are also responsible for increasing tropospheric ozone concentration that not only creates a greenhouse effect but also has carcinogenic properties. It was found that different types of paints, carpets, gypsum boards, and glues emit VOC into the air, causing symptoms like headache, nausea, dizziness, and sometimes the damaging liver and kidney (Environmental Protection Agency, n.d.). Research indicated that the indoor to outdoor ratio of VOC emission is greater than 2 to 5 (Environmental Protection Agency, n.d.). Most commonly found indoor VOCs are formaldehyde emitted from wood-based products flooring and furnishings, Toluene from carpets, xylenes from planters, and adhesives (Yu and Kim 2011). It was also found that the drying process of paints, wallpapers, or even finger paints emit VOCs. Another research revealed that the emission of VOCs is higher in winter, except for a few VOCs like formaldehyde and acetaldehyde (Wallace et al. 1991). In addition to building materials, occupants contribute to VOC generation. It was found that VOCs like aldehydes, ketones, alkanes, and many more VOCs are released by human skin which is more in adults than children (Zou, He, and Yang 2020) (Stonner, Edtbauer, and Williams 2018).

Temperature plays a role in the VOC levels. Research indicated that the concentration of VOC at nighttime is higher than daytime during the winter period (Wallace et al. 1991). Thus, it can be said that the concentration of VOCs increases at lower temperatures (Wallace et al. 1991). The emission of VOCs is constant under the changes of $\pm 2^\circ\text{C}$ temperature and $\pm 5\%$ relative humidity. While formaldehyde emission is doubled with a 7°C increase in temperature or the increase in relative humidity from 30% to 70% (Wolkoff 1998). As the relative humidity increases, the emission of VOCs also increases. (Markowicz 2015).

Table 1: Commonly found VOCs, their sources, and consequences of the human body. Source: (Environmental Protection Agency)

VOC	Acute REL target organs	Safe Harbour Level (Per day) (µg)	Occurrence
1,4 Dichlorobenzene	The nervous system, respiratory system, alimentary system, kidney	20	Insecticide, germicide, space and garbage deodorizer; chemical intermediate inorganic chemicals, dyes, and pharmaceuticals
Acetaldehyde	Respiratory system, eyes	90	Fruit and fish preservative, flavoring agent, denaturant for alcohol; solvent; component of tobacco smoke
Acrylic acid	Respiratory system, eyes		Polymers, paint, leather, and paper coatings, detergents, and water treatment chemicals;
Benzene	Reproductive/development, immune system, hematologic system	13	Veterinary medicine (disinfectant); production of detergents, pharmaceuticals, and dyestuffs;
Chloroform	Reproductive/development, nervous system, respiratory system		Pesticides; chemical intermediate;
Formaldehyde	Eye irritation	40	Disinfectant (antibacterial, fungicide), plastics, adhesives, preservatives, pressed wood products, automobile components
Methanol	Nervous System	47,000	solvent, antifreeze; chemical intermediate (formaldehyde, acetic acid)
n - Hexane	Nervous system		Cleaning agent (degreaser), low-temperature thermometer filling; component of solvents (edible oil extraction, adhesives)
Toluene	The nervous system, eye, respiratory system	13000	Solvent, cement for polystyrene kits; production of polymers; chemical intermediate (benzene dealkylation);
Xylenes	The nervous system, eye, respiratory system		Solvent for paints, varnishes, inks, dyes, adhesives, pharmaceuticals, detergents, and rubber; production of polymer fiber

1.0 BACKGROUND

1.1 Sick Building Syndrome

According to the US EPA, “sick building syndrome” (SBS) is a situation in which occupants of the building suffer from acute health and comfort issues that are linked to the time spent in a certain building. It is caused due to inadequate ventilation and indoor sources of air pollution like VOCs emitted by-products used inside the building. These VOCs are carcinogenic, that is they cause cancer and other health effects (Wallace 2000; Theloke and Friedrich 2007). Even low or moderate concentrations can cause breathing or skin-related problems.

1.2. Photocatalysis

To reduce or eliminate the concentration of VOCs, there are solutions such as reduction of VOC emitting materials and the use of low VOC products. Natural ventilation is also a passive design solution to reduce the concentration of indoor VOCs. However, natural ventilation could not be useful for thermal comfort in extreme weather. To this end, photocatalytic TiO₂ in presence of UV light can be an alternative solution to reduce VOCs indoors.

Photocatalysis follows the basic principle of the formation of electron-hole pairs by absorbing photons that have energy equal or greater to the semiconductor's material which excites the electrons producing reactive oxygen (Ameta et al. 2018). ZnS, CdS, ZrO₂ are a few of the semiconductors used for the process of photocatalysis (Yoneyama 1997; Fujiwara et al. 1997; Yoshida and Kohno 2001). TiO₂ is the most commonly used photocatalytic chemical. TiO₂ is a widely found, low-cost, and low maintenance material which also has strong oxidation properties (Weon et al. 2017). The efficacy of photocatalysis depends mainly on the intensity of UV rays and the amount of TiO₂ particles.

There is also a drawback that the UV rays have to be directly incident on the surface for maximum efficiency. Researchers are also focusing on using Vacuum UV which helps TiO₂ perform 70% better than UV irradiation (Shu et al. 2018). Researchers are working on the activation of TiO₂ in the presence of visible light spectrum (Etacheri et al. 2015). There are researchers doping TiO₂ with noble metals like Palladium that helps TiO₂ perform in a visible light spectrum with much more efficiency. It is also proven that doping TiO₂ increases the efficiency of TiO₂ photocatalysis by 90% since it oxidizes VOCs in visible light (Fujimoto et al. 2017). For the purpose of our research, we are mainly focusing on pure TiO₂ that performs under UVA rays. In addition, TiO₂ coated products allow the self-cleaning traits along with reducing the growth of phototrophic bacteria which are the reason for mold formation (Graziani et al. 2014). Therefore, our research focused on photocatalytic degradation of VOCs with TiO₂.

1.3. TiO₂ Coating

TiO₂ is usually made by laser interaction of titanium and oxygen in anatase form. (Fathi-Hafshejani et al. 2020). The coating of TiO₂ on stainless steel is rough thus larger surface area is formed which is much more beneficial for photocatalytic oxidation. Nanoparticle deposition system is a widely used technique to coat TiO₂. (Chun et al. 2008). The temperature of the substrate also plays a crucial role in the application of TiO₂ coating. Fine crystals of TiO₂ are formed when TiO₂ is coated on a cool substrate. The magnetron sputtering process for TiO₂ coating on TiO₂ films can be coated by heating the substrate. This is beneficial since the deposition of TiO₂ on low melting point substrates will be cost-saving (Zeman and Takabayashi 2002). TiO₂ films can be deposited on a silica glass substrate with the use of arc ion plating with a pulsed DC power supply with heating of the substrate. Hydrothermal-seeded techniques are also one of the effective techniques for obtaining porosity and anatase TiO₂ (Kartini et al. 2018).

2.0 METHOD

2.1.1. Testing Chamber Construction

A testing chamber was made from transparent acrylic sheets, as it would be beneficial to monitor the testing process and measure experiments. The size of the testing chamber is 35.5 cm x 35.5 cm x 35.5 with 10 mm thick acrylic sheets (Figure 1). All the acrylic sheets were joined together with 100% low-VOC silicone sealant. The top lid was made from glass attached to a foam board and was removable for positioning the samples and sensors. Since TiO₂ on the facade surface can be activated by UVA, it is important to let UV light penetrate the testing box with minimal absorption. We found that acrylic absorbs about 80~90% of UVA light through tests. Thus, 6 mm single pane glass was used instead of acrylic for the lid considering the altitude of the sun at the testing time (Figure 2). In addition, VOC sources and a fan were housed in a material holder box with 9.5 cm(w) x 18.0 cm(d) x 9.5 cm(h) dimension installed inside the testing chamber. After applying formaldehyde sources on woodblock, it was placed in front of the fan to circulate the indoor air evenly. The power required to operate the fan was provided by the solar power bank.

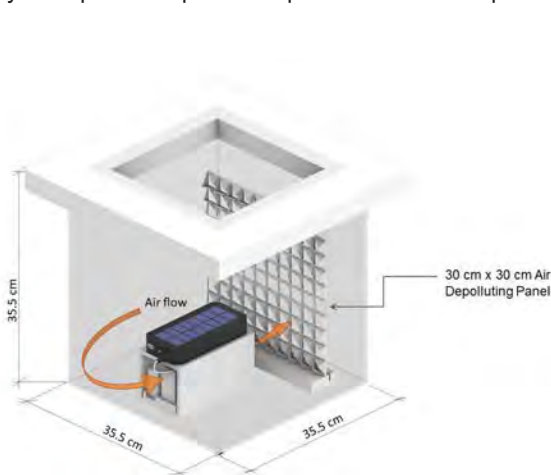

Figure 1: Testing Chamber - Isometric.

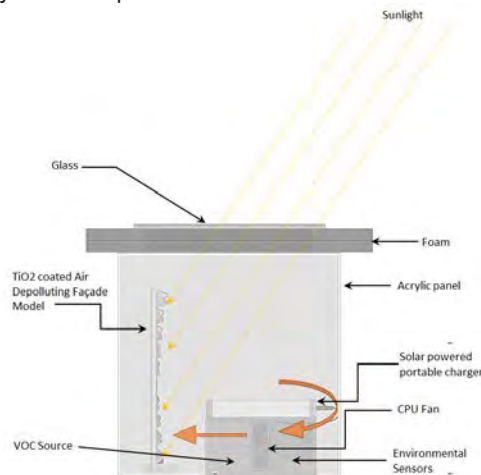

Figure 2: Testing Chamber - Side View.

2.1.2 Air quality and UV light Sensor

In this experiment, UV and HCHO sensors were connected to an Arduino Nano board to collect data. The UV sensor (Figure 3a) was used to measure the intensity of UVA light entering the testing box in the range of 320 to 400 nm. This sensor was made by Sparkfun using a VEML 6075 light sensor. The second sensor is DFRobot's HCHO sensor (Figure 3b) that can measure formaldehyde emitted from building materials such as silicone, glue, etc. This sensor can measure the range of 0-5 ppm formaldehyde in the indoor air. Both sensors were connected to the Arduino Nano (Figure 3c) and sensor data were collected at one-second intervals.

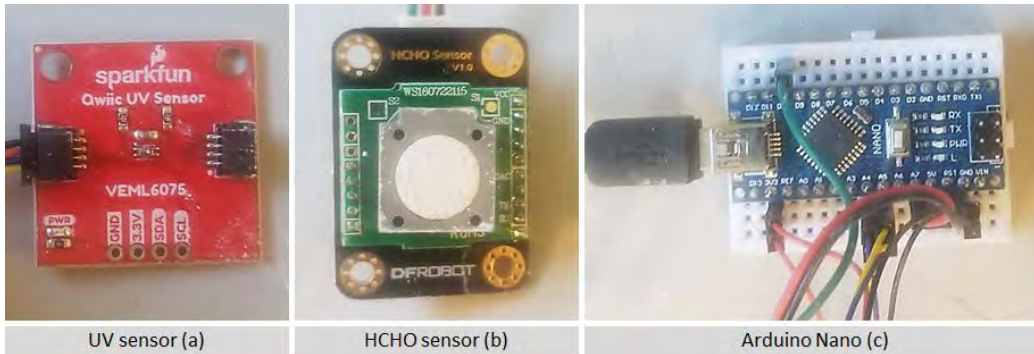

Figure 3: Air quality, UV light Sensor, and Arduino Nano

Table 2: Features of sensors

	UV sensor (Sparkfun)	HCHO sensor (DFROBOT)
Operating voltage range (V)	1.7-3.6 V	3.3-6 V
Resolution	0.93 counts/ μ W/cm ²	0.01 ppm
Detect range	UVA: 320~400 nm	0~5 ppm
Operating Temp	-40 °C ~ +85 °C	0 °C ~ 50 °C

2.1.3 TiO₂ Coated Facade Panels

Two TiO₂ facade specimens with a size of 30 cm x 30 cm were fabricated using a 3d printer. One specimen was coated with TiO₂ paste that was made from a mixture of power and water, applied with a brush to the facade panel. The other sample was prepared with TiO₂ spray that was applied on the facade and air-dried. Figure 4a shows the powder mixed with water and Figure 4b shows the spray type applied by spraying it on the facade surface.

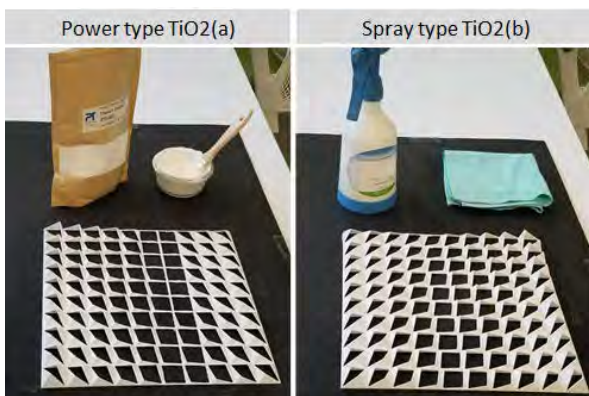

Figure 4: Two types of photocatalytic facades with TiO₂ coating

2.2. Procedure

First, facade samples, formaldehyde source on the wood panel, and sensors were placed inside the testing chamber. Next, the testing chamber was covered with a black curtain (Figure 5a) for 30 minutes to prevent TiO₂ from being activated by the sunlight. After 30 minutes, the black curtain was removed to expose the testing chamber to the sunlight (Figure 5b). The experiment was run for one hour and the sensors in the testing chamber measured the formaldehyde level (ppm) and UVA intensity (W/m²).



Figure 5: TiO₂ photocatalytic facade testing setup

3.0 RESULT AND DISCUSSION

In this study, sanitizer and silicone sealant were used as the VOC sources, and a total of four experiments were carried out by applying two types of TiO₂ samples, powder and spray. Table 3 summarizes the experimental setup of four different conditions.

Table 3: Four experiments for TiO₂ photocatalytic facades

Testing	Experiment conditions
A	Photocatalytic facade with TiO ₂ powder / Formaldehyde source from sanitizer
B	Photocatalytic facade with TiO ₂ powder / Formaldehyde source from silicone
C	Photocatalytic facade with TiO ₂ spray / Formaldehyde source from sanitizer
D	Photocatalytic facade with TiO ₂ spray / Formaldehyde source from silicone

Figure 6 shows experimental data in measuring the effect of photocatalytic facades in reducing air contaminants. First of all, it can be seen that both powder and spray types of TiO₂ on the facade surfaces are effective in reducing the formaldehyde emitted from the sanitizer and silicone. Although each experiment was exposed to different UVA intensity due to the natural variation from the sunlight, all experiments showed that the TiO₂ photocatalytic facades noticeably reduced the formaldehyde concentration. Another thing to note is that the formaldehyde level did not decrease proportionally with the UV light intensities. For example, when comparing the result from experiment A and C, although the UV intensity of experiment C is relatively lower than that of experiment A, the reduction rate of formaldehyde in experiment C using the TiO₂ spray (from 1.7 ppm to 0.7 ppm which was about 58%) is greater than the reduction rate in experiment A using the TiO₂ power (2.8 ppm to 1.5 ppm which was 46%). In the case of B and D, both power and spray cases showed a similar reduction rate with more than 70% regardless of UVA intensity. Another feature from the graphs is that although the UVA intensity in graphs A, C, and D fluctuates by time, the reduction amount of formaldehyde was not significantly affected by the UVA fluctuation. Especially in the case of experiment C, the UVA intensity at 2:40 pm was decreased sharply from 75 w/m² to 39 w/m², but formaldehyde concentration decreased constantly. As a result, this research found that both TiO₂ types on the facade surface were activated by UVA with a certain intensity level and effectively reduced indoor formaldehyde emitted from building materials.

CONCLUSION

People spend most of their time indoors. There is a correlation between indoor air quality and adverse health impacts. Common air pollutants are from building materials. The pandemic increased the use of sanitizing and cleaning products, making these sources of indoor pollution more relevant. This research focused on TiO₂ photocatalytic facades as an air quality control method. The effect of TiO₂ photocatalysis removing formaldehyde was studied. In both cases of powder-based and sprayed TiO₂ coating, a significant reduction of formaldehyde was observed. The TiO₂ powder reduced the formaldehyde by 40-70% while sprayed TiO₂ reduced the formaldehyde by 50-90%. Our experiment revealed that varying UV intensity has less effect on the reduction of formaldehyde. Therefore, it can be concluded that TiO₂ photocatalytic facade can improve indoor air quality.

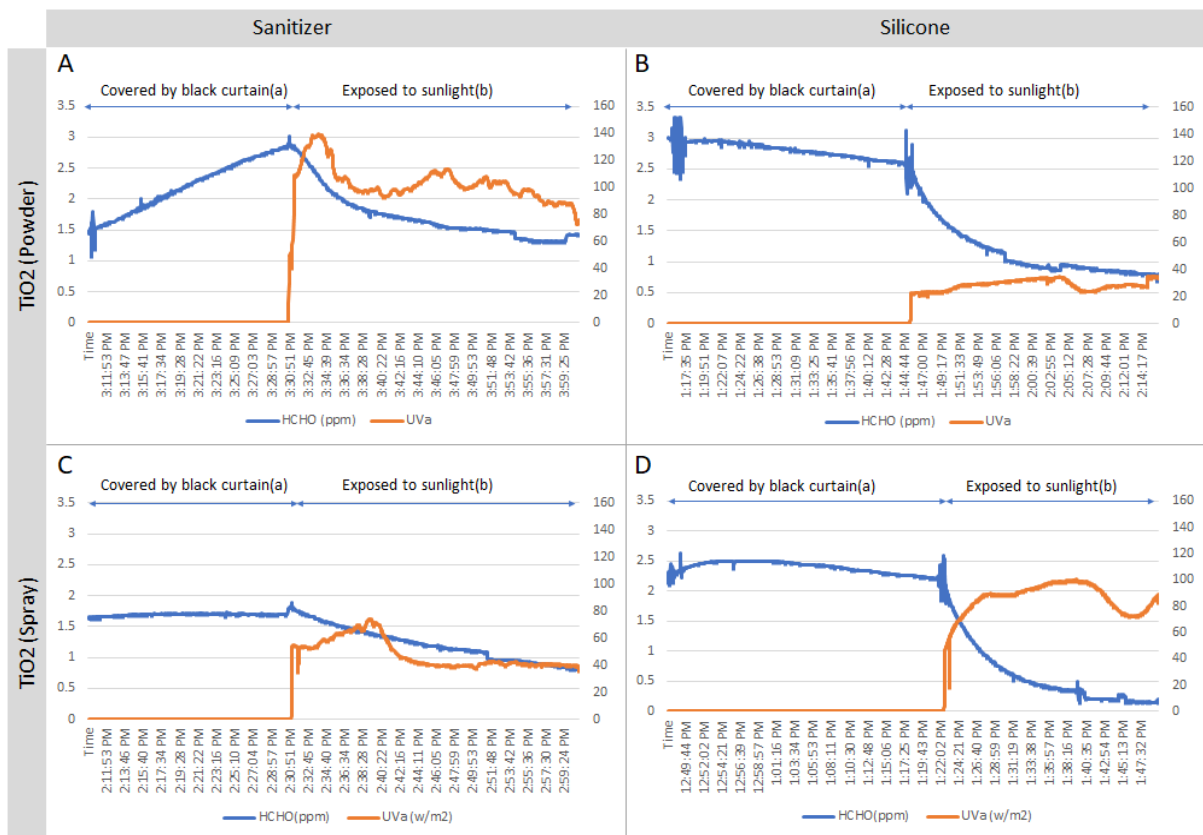

Figure 6: TiO₂ experimental results

ACKNOWLEDGEMENTS

The authors would like to acknowledge a 2020 NSF I-Corps Team program for funding support. The authors would like to thank Dante Gil Rivas, a graduate student at Rice University, who helped model the testing chamber.

REFERENCES

- Ameta, R., M. Solanki, S. Benjamin, and S. Ameta. 2018. *Advanced Oxidation Process for Waste Water Treatment*. Chennai: Candice Janco.
- Environmental Protection Agency. n.d. "Volatile Organic Compounds' Impact on Indoor Air Quality." *Indoor Air Quality*. <https://www.epa.gov/indoor-air-quality-iaq/volatile-organic-compounds-impact-indoor-air-quality>.
- Etacheri, V., C. Valentin, J. Schneider, D. Bahnemann, and S. Pillai. 2015. "Visible-light activation of TiO₂ photocatalysts: Advances in theory and experiments." *Journal of Photochemistry and Photobiology C: Photochemistry Reviews* 25:1-29.
- Fujiwara, H., H. Hosokawa, K. Murakoshi, Y. Wada, S. Yanagida, T. Okada, and H. Kobayashi. 1997. "Effect of surface structures on photocatalytic CO₂ reduction using quantized CdS nanocrystallites." *Journal of Physical Chemistry B* 101, no. 41 (October): 8270-8278.
- Shu, Y., Y. Xu, H. Huang, J. Ji, S. Liang, M. Wu, and D. Leung. 2018. "Catalytic oxidation of VOCs over Mn/TiO₂/activated carbon under 185 nm VUV irradiation." *Chemosphere* 208:550-558.
- Stonner, C., A. Edtbauer, and J. Williams. 2018. "Real-world volatile organic compound emission rates from seated adults and children for use in indoor air studies." *Indoor Air* 28.
- Theloke, J., and R. Friedrich. 2007. "Compilation of a database on the composition of anthropogenic VOC emissions for atmospheric modeling in Europe." *Atmospheric Environment* 41 (19): 4148-4160.
- Wallace, L., W. Nelson, R. Ziegenfuss, E. Pellizzari, L. Michael, R. Whitmore, H. Zelon, T. Hartwell, R. Perritt, and D. Westerdahl. 1991. "The Los Angeles TEAM Study: personal exposures, indoor-outdoor air concentrations, and breath concentrations of 25 volatile organic compounds." *Journal of Exposure Analysis and Environmental Epidemiology* 1, no. 2 (April): 157-192.
- Wallace, L. A. 1989. "The Total Exposure Assessment Methodology (TEAM) Study: An Analysis of Exposures, Sources, and Risks Associated with Four Volatile Organic Chemicals." *Journal of the American College of Toxicology* 8, no. 5 (September): 883-895.
- Wallace, L. A. 2000. *Assessing human exposure to volatile organic compounds*, in *Indoor Air Quality Handbook*. New York: n.p.
- Weon, S., J. Choi, T. Park, and W. Choi. 2017. "Freestanding doubly open-ended TiO₂ nanotubes for efficient photocatalytic degradation of volatile organic compounds." *Applied Catalysis B: Environmental* 205:386-392.
- Wolkoff, P. 1998. "Impact of air velocity, temperature, humidity, and air on long-term VOC emissions from building products." *Atmospheric Environment* 32 (14-15): 2659-2668. [https://doi.org/10.1016/S1352-2310\(97\)00402-0](https://doi.org/10.1016/S1352-2310(97)00402-0).
- Yoneyama, H. 1997. "Photoreduction of carbon dioxide on quantized semiconductor nanoparticles in solution." *Catalysis Today* 39 (3)
- Yoshida, S., and Y. Kohno. 2001. "A new type of photocatalysis initiated by photoexcitation of adsorbed carbon dioxide on ZrO₂." *Catalysis Surveys from Japan* 4, no. 2 (July): 107-114.
- Yu, C., and J. Kim. 2011. "Long-term Impact of Formaldehyde and VOC Emissions from Wood-based Products on Indoor Environments; and Issues with Recycled Products." *SAGE journals* 21, no. 1 (September): 137-149.
- Zou, Z., J. He, and X. Yang. 2020. "An experimental method for measuring VOC emissions from individual human whole-body skin under controlled conditions." *Building and Environment* 181.

Modular Makeup: Reconsidering Modularity of Gypsum Wallboard

Alyssa Kuhns¹, Jeff Kim²

¹University of Arkansas, Fayetteville, AR

²Auburn University, Auburn, AL

ABSTRACT: 2017 marked the 100th Anniversary of Sheetrock. Sheetrock, or gypsum wallboard, is the dominant material used in the construction and finishing of interior partitions. Despite its proliferation as a modularized commodity, both the manufacturing and installation methods of Sheetrock have remained essentially unchanged in the hundred-year span of its existence. Unlike other interior finishes –hardwood flooring, ceramic tile – gypsum wallboard is a modular unit that is finished as a homogeneous surface. The finishing process results in uniformity but requires highly skilled labor, creates excessive waste, and prevents the deconstruction and reuse of gypsum wallboard panels. Addressing these concerns, this research investigates the modular make-up of gypsum wallboard both from historical and contemporary perspectives. Through interviews with industry partners and on-site observation of installation methods, we documented the impact of gypsum wallboard modularization on accepted installation practices. This preliminary research informed explorations in reconsidering modularity of gypsum wallboard systems, employing both low-tech techniques such as casting and mold-making as well as high-tech applications of computational design. The resultants of these methods were evaluated based on their ability to create efficiencies in the installation process, both in terms of labor and waste. This paper summarizes findings of the preliminary research, including historical and contemporary impacts of gypsum wallboard modularization, and introduces methods of reconsidering modularity to address challenges associated with installation practices.

KEYWORDS: gypsum wallboard, modularity, fabrication, installation, construction practices

INTRODUCTION

With the advent of gypsum wallboard panels, interior finishing went from being a craft to a commodity. Despite the development of manufacturing methods to produce standardized panels, the gypsum wallboard installation process was and still is a hybridized technique. Manufactured panels are used in conjunction with hand-crafted on-site work to produce a cohesive interior finish. While laborers can quickly cover large areas with full-size gypsum wallboard panels, they are also required to cut custom sizes and finish seams to create a unified surface. These aspects of the installation process perpetuate the production of waste and dependency on highly skilled labor in gypsum wallboard installation.

The concern over labor dependency stems from consistent shortages of skilled labor in the construction industry that have been exacerbated by the pandemic. With a lack of skilled labor, the quality of gypsum wallboard installation and finishing has decreased. Alana Parker, owner of the gypsum wallboard supplier Rocket City Drywall, notes that home builders throughout the Alabama region have considered reducing the amount of natural light in rooms to make discrepancies in gypsum wallboard finishes less visible.

In addition to installation and finishing processes requiring skilled labor, they also create excessive waste. This is in part due to board cutoffs that are not typically salvaged on site because of low material costs. Additionally, gypsum wallboard material cannot be deconstructed or reused and, as a result, waste is also generated through the demolition. In total, these factors contribute to “13 million tons of gypsum wallboard debris generated in the US every year, 85% of which is landfilled” (Closed Loop Wallboard). Unfortunately, material efficiencies and on-site recycling are not currently valued by the industry since labor costs outweigh material costs. Therefore, to incentivize reductions in material waste, material efficiencies need to be tied to labor efficiencies.

To address issues of both labor shortages and waste associated with gypsum wallboard installation, this paper examines the impact of gypsum wallboard modularization on the installation process. This is done by outlining the historical and contemporary context of the manufacturing and installation of gypsum wallboard and offering alternative methods in considering modularization of this ubiquitous product.

1.0 HISTORICAL AND CURRENT TRENDS OF WALLBOARD MODULARIZATION

This section of the paper begins with an abbreviated history of gypsum wallboard through an examination of its earlier variants and the exogenous factors that helped shape the modern wallboard industry. This examination is also supported by taking a glimpse into the research of modularization as a means for making interior spaces more versatile while increasing design possibilities. This merging of modularization concepts to the modern uses of gypsum wallboard design and construction has potential ramifications for waste mitigation and construction practices that are paramount to today's sustainability-focused initiatives.

1.1. History

The history of gypsum wallboard in the US began in the early 1900s with the conventional interior partition construction consisting of lath and plaster. The process included lath which is a series of horizontal wooden slats nailed across wall studs or across ceiling joists then coated with multiple layers of plaster as the finished surface. The process of constructing these types of interior partitions was time-consuming and required a high level of skilled labor. An alternative was needed that could address these fundamental issues of lath and plaster construction while maintaining some attention toward flexibility and economized cost of labor and materials.

In the US, alternatives were sought to minimize the time to install the lath boards. In some regions of the country, the boards were often in short supply when milling factories were unable to keep up with the demand that a post-World War II housing boom created (Schwartz 2007). Panelized products made to replace the lath backing for walls were the precursor to a simplified wallboard assembly, however, this replacement still needed to be finished with multiple layers of plaster that required days of curing between the subsequent layers. To address this shortcoming of lath and plaster construction, Augustine Sackett, in 1890 was issued a patent for manufacturing a panelized product that did not require lath or a series of plaster layers as a finish surface. The product was a gypsum cement paste sandwiched between two layers of sheathing paper and cured so that the product could be installed as the finished product ready to receive whatever finish was desired (U.S. Patent No. 520123 1894). At the time, the boards were produced at 3/16 inch thick and roughly 36 inches square but did not gain widespread use until the housing boom after World War II (The Gypsum Association 2005). Around the same time as Sackett's patent, the US government began advocating for improved standards for manufactured products and founded the US Industries Board. Their aim was mainly in response to manufacturing around World War I but persisted in the US through World War II and affected products used to build the military infrastructure in the US (Bucher 2012). Chiefly among these standards was the use of wallboard, namely Sackett's patented product, that became a significant building material in military barracks. The new wallboard's quality was consistent, and its installation was significantly shorter than traditional lath and plaster.

Despite the pressures that the US Industries Board had on the early use for gypsum wallboard for the military, its use in the commercial sector was not significantly changed until after World War II (Bucher 2012). Around this time, the United States Gypsum Company purchased the patent, and several plants began producing Sackett's wallboard products. This along with modernizations concerning folded edge strengthening, the establishment of 4-foot standard widths, the use of cloth mesh, and plaster to join and finish panel edges enabled the gypsum wallboard product to realize mainstream use in the commercial building and residential industries. Future enhancements would also include fire-rated boards, water-resistant boards, and the use of synthetic gypsum.

1.2. Modularization Alternatives

Despite the move from lath and plaster to a panelized gypsum wallboard product, there remains an inherent inefficiency in the process of constructing a gypsum wallboard partition. The nature of constructing on-site is generally considered time-consuming and involves a significant output of waste for a project (Hansen 2020). Some researchers suggest that disrupting the current paradigm of in-situ construction is one way to respond to these contemporary challenges (Cucuzza 2021). Cucuzza et al.'s research considers moving certain operations off-site to streamline the process and support it by way of a "Panelization Design Tool" that is capable of automating parts of the design process early enough in the project to support modularization as an alternative option to traditional construction means and methods (2021). Similarly, Holley and Mancill proposed a methodology that incorporated the use of light detection and ranging (LiDAR) systems to scan an interior wall surface that required meticulous measurements and laborious field cuts for thru-wall penetrations of a gypsum wallboard partition (2014). By pre-scanning thru-wall penetration locations before installing the gypsum wallboard, they were able to produce detailed shop drawings that were used to manufacture modular gypsum wallboard panels off-site and in a controlled environment. The precision cutting that happened off-site resulted in improved quality of the finished product. As a proof-of-concept, their study highlights an opportunity for modularization within traditional construction techniques. It is these, among other similar research efforts, that invite a consideration of the panelization process as a means for improving the traditional gypsum wallboard assembly. Efficiencies in the construction process using modularization open additional opportunities for the design of contemporary partitions. A broader variation of design becomes available when the traditional monolithic gypsum wallboard assembly is addressed as a panelized and modular surface.

Panelized and modular wallboard assemblies that resemble the ones referred to in the previous paragraph are currently available as demountable and unitized partitions which are semi-permanent structures used to create individual spaces and are crafted from a variety of materials. It can be reasoned that demountable and unitized modular partitions challenge the permanency of conventional interior wall construction used for dividing spaces. An alternative design consideration arises with the merging of the demountable partition with some facet of a gypsum wallboard assembly. The recent impacts that prefabrication is having on the built environment are immeasurable at the moment, however, they do elicit a notion that our current methods are situated for change. The demountable partition has utility, and while temporary, can also contain infrastructure for building systems such as HVAC, plumbing, electrical, and others (Vandervaeren 2020). Reconsidering a wallboard system that is as versatile as conventional demountable and unitized partitions begins to introduce concepts of premanufacturing and has the potential to reduce waste without sacrificing options for design.

1.3. Commentary and Industry Perspectives

As a part of this study, we developed relationships with industry partners to understand the impacts of modularity on embedded practices of manufacturing and installation. Contemporary manufacturing practices are developed around the ability to produce standard module sizes at high volumes. At USG, panels are produced by pouring stucco directly onto paper backing with folded edges that act as a mold for the wet material. The paper and stucco assembly is then rolled across a board line to cure. This produces a continuous wallboard typically 4 feet wide by hundreds of feet in length. The continuous wallboard is cut into desired typical lengths of 8 feet, 10 feet, 12 feet, etc. before the boards are sent to the kiln to fully cure. (USG, site visit, 2019). While custom sizes can be requested for large-scale orders, typically manufacturers produce standard module sizes of gypsum wallboard, leaving cutting of custom sizes to be done by hand, on-site. The module size is a significant consideration since it impacts installation practices and waste generated from board cutoffs.

In addition to understanding standard industry practices of module production of gypsum wallboard, we interviewed a trade contractor that has taken an innovative look at premanufacturing interior wall construction assemblies. The Raymond Group is an interiors construction company that undertakes the work of prefabrication for parts of their process to increase productivity, improve quality, and reduce cost. An interview was conducted with their Director of Prefabrication to understand their process and to learn about their challenges and successes with the prefabrication of gypsum wallboard panels.

Overview

The Raymond Group undertakes premanufacturing on select projects, typically large scale, where the process is feasible and can save on productivity and cost. Unfortunately, this is not all their projects, but they are broadening their understanding and skills in the hopes that more projects can include prefabrication.

The process begins before construction with detailers preparing shop drawings that are used to panelize parts of the project. The shop drawings are digitally drafted by a detailer who determines a layout of full and partial gypsum wallboard panels. This procedure focuses on production output at the “home” shop using a drywall milling machine to precut panel sizes and, after, the materials are delivered to the construction project site numbered according to their layout.



Figure 1: The Raymond Group’s drywall prefabrication shop. Source: (The Raymond Group, 2021).

Precision Through Premanufacture

Some project teams “get it” and involve the Raymond Group early enough in the project to make the best use of the prefabrication process. Often, the struggle is about convincing people internal to The Raymond Group that prefabrication will make a project more successful.

I'm still fighting with people inside of my own company that prefabrication, actually is better, it's a mindset, you [have to] have the mindset to see it to get it.

While the struggle remains to convince people inside and outside of the company, the impact that prefabrication is having on quality is noticeable. Prefabrication benefits from a controlled environment at the “home” shop, where tools and materials are readily available at efficient working heights geared toward maximizing output. Simple workmanship items such as a consistent screw depth penetration to cut sharp edges ensure a better tape and mud finish when the panels are joined in the field. Also, when the work crews are cutting the panels at the “home” shop, they get more precise edges and have the ability to cut mitered corners for better joining by the installation crews in the field. The Director of Prefabrication noted:

There's [an] easier install, these are all the intangible things that you can't quantify, but you know that they are better.”

Continuous Improvement

Production manufacturing benefits from continuous improvement where each step in the process of prefabrication is scrutinized in ever shorter durations of assembly (Meiling 2012). The director at The Raymond Group offered:

[W]e've got the main processes down with [our equipment] we've got machines we know how to use, we know how to draw - we know we've got that down through the last four years of doing it. Now it's just all those little processes like finding out what the field has to cut out in the field and getting machines to do it inside the shop.

Expecting that premanufacturing continually improves requires an attention toward re-training. The Raymond Group carpenters reassign some of their best carpenters to shop work instead of working at the construction project site. This transition was necessary to make sure that the skillset was in the best location for training and to maintain quality and production expectations, as noted by the director:

We have some apprentices and people like that where we can but we're going for speed and it's all about speed for production [...].

This process of continuous improvement is fostered by a feedback loop that allows the “home” shop to encourage new ways of doing things on the assembly line. The Raymond Group listens to their production staff and changes their process constantly:

[...] we brainstorm all the time, we come up with new ideas, we had to get into the [shop] guy's head and come up with a plan of how we're going to execute, we're gonna change the plan a million times, you're gonna change the plan five minutes after you start.

The commentary offered by the Director of Prefabrication was informative to this research. Chiefly, for this research study, the conversation adds validity to the notion that prefabrication of gypsum wallboard panels is necessary if we are to improve construction installation and reduce waste in the process. Furthermore, realizing that The Raymond Group moved their production offsite to a “home” shop indicates that there is lost productivity when gypsum wallboard assemblies are constructed at the construction project site – this should encourage the industry to reconsider new products aimed at addressing this concern. It is thereby proposed that allowing the industry to improve their process, focusing on productivity and quality, will open new opportunities for reconsidering the monolithic design of contemporary gypsum wallboard partitions.

2.0 METHODOLOGY OF MODULAR RECONSIDERATION

By thoroughly understanding historical and current practices related to modularity within the gypsum wallboard material system, the shortcomings of those practices serve as criteria to reconsider the module aspects of the product. The findings of the preliminary research informed both physical and digital explorations studying the impact of modularity on installation practices. This portion of the paper is dedicated to describing prototyping and testing methodologies that consider module size of gypsum wallboard panels as well as prefabrication and installation techniques as points of redesign. The purpose of working within these parameters is to reduce on-site waste and dependencies on highly skilled labor through prefabrication processes while also considering opportunities for deconstruction, reuse, and recycling.

2.1. Modular Mock-up

To study the impact of gypsum wallboard modularity on the installation process, we created a full-scale framed mock-up to serve as a testing ground. Installation of various modules size was performed and documented to study the relationship between module and method. Each tested module size was derived by the division of a standard 4-foot by 8-foot sheet of gypsum wallboard and installed by a single, amateur laborer. The installation of each module size was examined based on the following criteria.



Figure 1: Installation of various gypsum panel sizes. Source: (Author 2020)

Orientation: Except for the square module, each module had an inherent directional orientation based on its proportion of width to height. In addition to the panel's orientation, each panel could be installed orientated vertically or horizontally on the framing. The orientation of both the panel and installation impacted the laborer's ability to grip, lift, and hold the panel during installation as well as the panel patterning needed to complete the wall surface.

Pattern: In this test, seams were to remain unfinished and would therefore be visible. As a result, the module size impacted the number and placement of seams across the wall surface, creating a pattern. Patterns could be oriented horizontally or vertically and were affected based on the ability of the module size to complete standard wall dimensions.

Ease of Installation: Modules of various sizes had different implications relative to installation. Modules were considered based on how they were gripped, their weight when being moved, their center of gravity and weight while lifting into place, and their ability to be held in place while being attached to the framing.

Attachment: Modules were secured to the wall framing using traditional drywall screws. Screws were needed on all edges of each module as well as on 16-inch intervals within the surface of the module. Any seam between gypsum wallboard panels doubles the amount of hardware needed to secure each panel, and panels with a small surface area are dependent on attachment at the edges to secure the panels to the framing.

Finishing: Initial findings determined that mid-sized panels, such as panels 2 feet, 4 inches wide by 4 feet tall, were manageable for a single, amateur laborer to hold, lift, and install while still covering a significant wall area and maintaining enough surface area for secure attachment. Smaller panels, while easy to move and install and best for creating a range of module patterning options, did not have enough surface area for secure attachment and created more seams, requiring more hardware.

Despite its shortcomings, the smallest panel size, 16 inches by 16 inches, was used to test small-scale production methods of custom panels that replicated techniques used in large-scale manufacturing of gypsum wallboard. In this work, a pedestrian version of stucco – quick-setting gypsum plaster and water – was poured or cast into molds lined with a paper backing. This method allows for the creation of custom panels that can test a variety of module sizes as well as edge and surface conditions. The development of this process allows for the design and testing of gypsum wallboard product advances that address issues associated with installation and finishing practices as well as aesthetic concerns.



Figure 2: Cast gypsum wallboard panels demonstrated method for small scale fabrication. Source: (Author 2021)

2.2. Parametric Permutations

To expand on The Raymond Group’s approach to prefabrication of gypsum wallboard panels, we integrated methods of automation based on parametric and computational perimeters. While reconsidering module size as outlined above results in shorter cuts and easier installation, efficiencies in gypsum wallboard installation come from maximizing the use of full-sized 4-foot by 8-foot sheets. The use of full-size sheets reduces the number of cuts and increases the use of factory edges, which results in less dependency on skilled labor and increased levels of finish. Less important to contractors due to minimal cost savings but significant for those concerned about climate impacts of material production and waste, there is also the need to consider waste created through on-site board cut-offs. Therefore, the goal of using parametric parameters is to maximize the use of full boards while reducing the total material needed and the resulting number of cuts and seams of the overall layout.

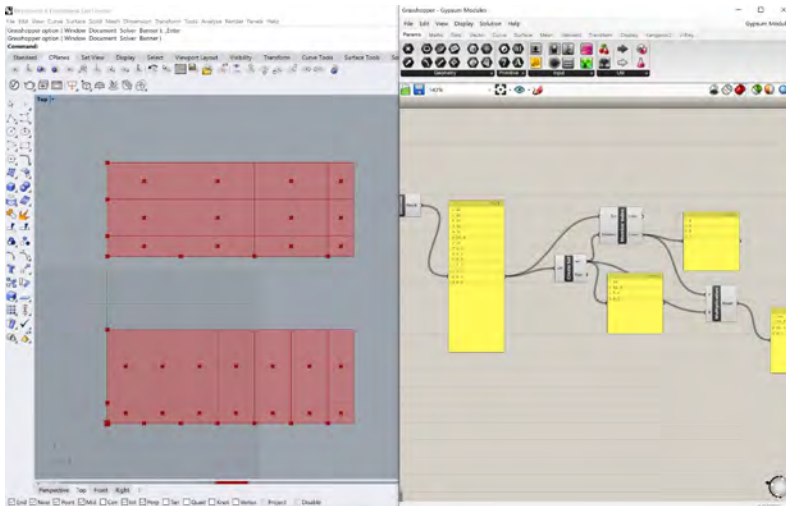

Figure 3: Parametric layouts of gypsum wallboard. Source: (Author 2021)

To develop a method of permutating through gypsum wallboard layouts to determine efficiencies, Grasshopper was used. The developed Grasshopper definition is based solely on the inputs of length and width of the wall. Using these inputs, the definition automates layouts of standard 4-foot by 8-foot boards oriented both horizontally and vertically. In addition to full board sizes, the remainder of the wall is divided into either 4-foot or 8-foot segments to ensure these partial panels can be cut from a full-size board. In the end, the Grasshopper definition outputs a number of statistics to help determine an efficient layout that would reduce the number of cuts and seams. These include:

- The number and total square feet of full-size boards
- Total square feet of partial panels and length and width of individual partial panels
- Linear feet of horizontal seams
- Linear feet of vertical seams
- Total linear feet of seams

Ideally, the most efficient layout would maximize the amount of square feet covered by full-size boards and minimize the amount of square feet of partial panels. Also, a layout with fewer total linear feet of seams and more horizontal seams than vertical seams would create cleaner seams that are easier to finish, reducing the amount of skilled labor required.

Once the overall layout approach is determined, the partial panels are distributed onto full-size boards. Permutations of the layout of the partial panels are developed to determine an efficient layout that would reduce cut-off waste. The layout can then be used to generate cut patterns for CNC routing to prefabricate partial panels so that cutting is automated and performed off-site.

3.0 FINDINGS

3.1. Summary of Outcomes

This section outlines a summary of findings to both highlight significant takeaways and note research parameters for further advancement of the work. Historically, advancements in manufacturing and prefabrication have proven to create on-site construction efficiencies – reducing time, increasing speed, and, therefore, decreasing costs. The Raymond Group confirms these results. By laying out gypsum wallboard modules in advance and using their best laborers to

facilitate the prefabrication process, The Raymond Group maximizes the use of full-size boards, speeds up the cutting and installation process, and uses milling machines to cut sharper edges to reduce dependencies on highly skilled labor and produce higher levels of finish. Board cutoffs typically generated by in situ cutting are either landfilled or salvaged through a curated process of on-site source separation, which, while effective, is difficult to implement. The prefabrication process allows for the collection of board scrap that is already segregated from other building material waste and debris. While the recycling of scrap from prefabrication is not yet fully realized to its best potential, there are clear opportunities and a low-barrier to entry to implement these practices.

Installation testing of various modules sizes proved that mid-sized modules are easiest to install while still covering a good amount of surface area. The smaller module size does create more linear feet of seams which would increase the need for skilled labor if using finishing practices. Developing casting methods used to produce panels allows for the manipulation of edge conditions that could potentially eliminate finishing practices. Like 3D printing, casting can be considered an additive process where no material is cut, removed, or discarded to produce a panel. Custom panel sizes can be manufactured using cast techniques which would eliminate any board scrap waste.

Finally, a computational approach to gypsum wallboard layouts generates values to help determine efficiencies in both material use and labor. By increasing the use of full-sized boards, decreasing the number of partial panels, and limiting the total amount of linear feet of seams, parametrically generated layouts can have a direct impact on the required time and skill of labor. Automated layouts and milling of partial panels create material efficiencies and produce clean panels edges, making seams easier to finish.

3.1. Potential Impacts on Installation Practices

To advance this work to have greater impacts on installation practices, next steps include the continued testing of both analog and digital prototypes for gypsum wallboard installation. In particular, the casting process will develop to include considerations of edge and surface conditions of the panels. These developments would impact the need for finishing and would consider gypsum wallboard as an exposed modular system. Development of the computational methods would consider layouts of various panel sizes so that patterning of exposed modules could be determined in advance.

By incorporating computational modeling into future phases of this research, real-world impacts such as labor costs, both during the prefabrication process and on-site, and waste quantities could be determined. Next steps would include continued engagement with subcontractors such as The Raymond Group to determine how computationally derived layouts and automated CNC milling operations could fit into their existing prefabrication systems. The goal would be to decrease waste from scrap material without increasing required labor and establish processes to ensure waste from the prefabrication process is being recycled as feedback for new gypsum wallboard in lieu of contributing to landfills.

CONCLUSION

To understand the potential of modularization and prefabrication of gypsum wallboard, it is important to first understand historical and contemporary impacts and perspectives. The simple innovation of paper backing and folded edges in the early 1900s created opportunities for the advancement of gypsum wallboard manufacturing. Since that time, little has changed in the manufacturing and installation practices of the product. Now, with the availability of skilled labor continuing to decline, increased concerns over climate change and resource depletion, and advancements in computationally based technologies, the product and practices of gypsum wallboard can be reconsidered. This research simultaneously considers both small-scale production of gypsum panels and larger systemic changes to prefabrication and installation processes couched in the context of embodied industry knowledge to impact issues of labor and waste within the gypsum wallboard material system.

ACKNOWLEDGEMENTS

Portions of this research were funded by the Center for Construction Innovation and Collaboration as well as the College of Architecture, Design and Construction's McWhorter Fund for Excellence at Auburn University.

REFERENCES

- Bucher, C. 2012. "Dating twentieth-century buildings by means of construction materials." *APT Bulletin: The Journal of Preservation Technology*, 43(2/3): 71-76.
- "Closed Loop Wallboard – Collaborative." Building Product Ecosystems LLC. Accessed April 3, 2020. <https://www.buildingproductecosystems.org/closed-loop-wallboard>.
- Cucuzza M., Masera M., Iannaccone G., Mainini A., Stefano A., Lencioni L., and Enna M. 2021. "A Panelization Design Tool to Inform Decisions About Façade Geometry and Environmental Performances." In: Littlewood J.R., Howlett R.J., Jain L.C. (eds) *Sustainability in Energy and Buildings 2021. Smart Innovation, Systems and Technologies*, vol 263. Springer, Singapore. https://doi.org/10.1007/978-981-16-6269-0_44.
- Foley, T. 2015. *A Company History*. United States Gypsum.
- Hansen, S. and Sadeghian P. 2020. "Recycled gypsum powder from waste drywalls combined with fly ash for partial cement replacement in concrete." *Journal of Cleaner Production*, 274(122785): 1-15.
- Holley P. and Mancill S. 2013. "Employing LiDAR Scanning for Drywall Prefabrication: A Qualitative Pilot Proof of Concept Study." *Construction Research Congress*, 2014. <https://doi.org/10.1061/9780784413517.025>.
- Meiling, J., Backlund, F., and Johnsson, H. 2012. "Managing for continuous improvement in off-site construction: Evaluation of lean management principles." *Engineering, Construction and Architectural Management*, vol. 19, no. 2: 141-158.
- Parker, A. (owner and president, Rocket City Drywall & Supply, Inc.), in discussion with the author, July 2020.
- Ross, S. (Director of Prefabrication, The Raymond Group), in discussion with the author, April 2021.
- Schwartz, Max and Walter F. Pruter, contributing ed. 2005. *Builder's Guide to Stucco, Lath and Plaster*. Canoga Park, California: Builder's Book, Inc.
- The Gypsum Association. 2005. *75 Years of Service*. Hysattville, Maryland: The Gypsum Association.
- U.S. Patent No. 520123. 1894. *Inside Wall Covering*.
- Vandervaeren C., Denis F., Galle W., and Temmereman N. 2020. "Challenging Architectural Design Choices with Quantified Evaluations of the Generality and Adaptability of Plan Layouts." *Sustainability in Energy and Buildings*, 2020, vol 203. https://doi.org/10.1007/978-981-15-8783-2_13.

Topology + Timber

Tsz Yan Ng¹, Wes McGee¹

¹University of Michigan, Ann Arbor, MI

ABSTRACT: This paper details a year-long M.Arch thesis course that examined timber construction through the lens of computational design and digital fabrication technologies. There is a renewed interest surrounding timber construction in the building industry. It is currently at an inflection point—widespread implementation, building code revisions, and innovative fabrication techniques are on the near horizon—and these new developments in timber construction will have an outsized impact on our built environment. The sponsored studio in collaboration with Skidmore Owings & Merrill (SOM) situated research, full-scale prototyping, and design development as applied research for a small-scale timber structure. The course, in addition to an extensive exposure to Computer Numeric Controlled (CNC) manufacturing technologies, included a comprehensive pedagogy that combined heuristic knowledge in material making and research, linking professional practice and engineering consultation with an architectural firm, with socially driven inspirations from Freedom Schools of the '60s to create an outdoor classroom for a Chicago Public School. As such, the reframing not only reconsidered timber construction with contemporary technology to redefine construction practices, but also deviated from the typical digitally fabricated pavilion as proof of concept devoid of programmatic drivers. The paper outlines not only the fall seminar preparation for the winter design studio but also highlights the challenges for the design studio that centers on computational design and physical prototyping for reciprocal frame structures. The focus of the studio centered on reciprocal frame research, design, and construction, using dimensional lumber, namely 2X4s, in a series of studies to propose alternative framing possibilities outside of typical domestic-scaled balloon framing. 5-axis milling explored complex joint conditions considered prohibitive in manual construction, offering assembly systems that is quick to manufacture and easy to assemble.

KEYWORDS: Prototyping, Timber, Reciprocal Frame, CNC technology

INTRODUCTION

In 2019, an announcement was made that the 2021 International Building Code (IBC) would be updated to reflect mass timber construction systems for mid-rise construction (up to 18 stories) for residential and business occupancy. (Breneman 2019) The update included changes to fire-resistance ratings and required noncombustible protection on mass timber elements. The code revision signaled the broad enthusiasm toward timber products as a renewable resource that is less carbon intensive compared to other building materials such as concrete and steel. (Kremer and Symmons 2015) As a renewable plant-based material, wood captures carbon emissions that effectively reduce overall embodied carbon in new constructions and ultimately translates to reductions in global warming effects. With engineered products such as cross/nail/dowel/glue-laminated timber (CLT, NLT, DLT, GLT), wood construction is no longer limited in terms of scale by the sawn timber's size. Simultaneous to the growing popularity with engineered timber products, technologies for digital fabrication have also reconfigured timber construction. Most notable is DFAB HOUSE in the use of robotic processes for assembly whereby labor in framing is substantially reduced through automation and tolerances are managed for material deviations. (Thoma 2019) Concurrent to advances in digital fabrication, computational analysis, namely topology optimization, is also applied to simulate design options relative to formal expression and can calculate structural efficiency which ultimately translates to material efficiency.

While each of these areas present exciting opportunities for innovation, the technical knowledge necessary to effectively leverage each's influence, e.g., between the knowledge in material crafting, design, prototyping, and computational analysis, is complex and involved, creating a barrier for Masters level students in architecture to engage in. These students may not have had the formal technical training as part of their two/three-year professional curriculum to get to a level where these diverse areas of building technology can be integrated. It is this premise that prompted the pedagogy development of the year-long M.Arch thesis course *Topology + timber*.

Topology + timber studio is structured to integrate computational design and digital fabrication processes as intrinsic to today's architectural training. For advanced design studio teaching, it provides an opportunity to address comprehensive design integration that incorporates innovations in construction technology (technical) and broader impact as it relates to the discipline (socially, politically, and culturally), all the while situating the work within historical and contemporary influences. The motivation for this type of comprehensive studio is that there is a desire for students to gain skills in computational design and digital fabrication, especially as architectural offices are responding to the growing demand for these skills from the building industry. The difficulty lies in the training, so as not to treat it as purely

a tool/technique-based curriculum, but rather, to remain exploratory and experimental for the students as a design studio. This includes addressing broader disciplinary and design concerns such as context to site parameters, programmatic charge with users, and historical and social underpinning. This paper details the curriculum of this year-long thesis course, along with results and discussion of successes and challenges.

1.0 COURSE STRUCTURE, PEDAGOGY

Topology + timber was structured as a three-credit fall semester seminar followed by a six-credit winter semester design studio. During the fall seminar, students gained technical training through a series of exercises that prepared them for the winter term design studio. As an SOM sponsored studio, the pedagogy was co-developed to design, fabricate, and install a timber pavilion (as a studio team) using advanced digital technologies. SOM's engagement was intended to inject more in-depth computational design teaching for the thesis group in the form of workshops and reviews. The pedagogical engagement with SOM allowed the students the opportunity to connect what they learned in the classroom with professional practice (including structural engineering consultation) and real-life design applications. The winter design studio is linked with Wes McGee's Advanced Digital Fabrication seminar where students received specialized training to work with tools and techniques unique to their material exploration. Their work is expanded in the design studio setting where it can be situated and tested against their design motivations.

While technical in scope, the course incorporated socially driven motivations. Most research teams that produce pavilions as proof-of-concept demonstrators usually ignore users and the projects are often devoid of context. The approach for the pavilion was to activate it with a specific program. Inspired by healthy outdoor learning spaces driven by the Covid-19 pandemic and Freedom Schools, the timber structure would become an outdoor classroom/learning space. Freedom Schools, which were informal alternative learning spaces due to inadequate public education for Black communities in the first half the 20th C. in the US, created spaces where civic engagement was taught and promoted, and community-based bond reinforced. (Hale 2011) Chicago has a strong community called Chicago Freedom School founded in 2007. (Hinkel 2020) (Fig. 1) (Also ref. *Chicago Freedom School*) We partnered with a Chicago Public School (CPS), Ray Elementary in Hyde Park (a public school with the student body made up of predominantly minorities) to incorporate community engagement as part of the studio pedagogy and SOM's presence in Chicago provided a direct line of communication. The motivation in creating these exchanges was to understand the real-life impact and contingencies that shape design decisions. It also injected socially, culturally, and civically charged ambitions to reinforce the notion that technically driven courses such as design build/fabrication can have broader societal impact. The winter design studio also included an Identity Workshop led by Taubman College's Diversity Equity & Inclusion (DEI) officer Joana Dos Santos. The workshop prepared the students for community outreach, ensuring that the space for conversation was an inclusive environment. The intent was for the students to be exposed to not just *why*, but *how* to work with communities outside of one's immediate world. It also reinforced the responsibility to be conscientious about racial equity in the sense of working *with* POC and *for* POC. Based on the initial conversation with the principal at Ray Elementary, the program for the timber pavilion would function as a flexible space for learning, performance, and social gathering, both during classes/recess time and outside of it.

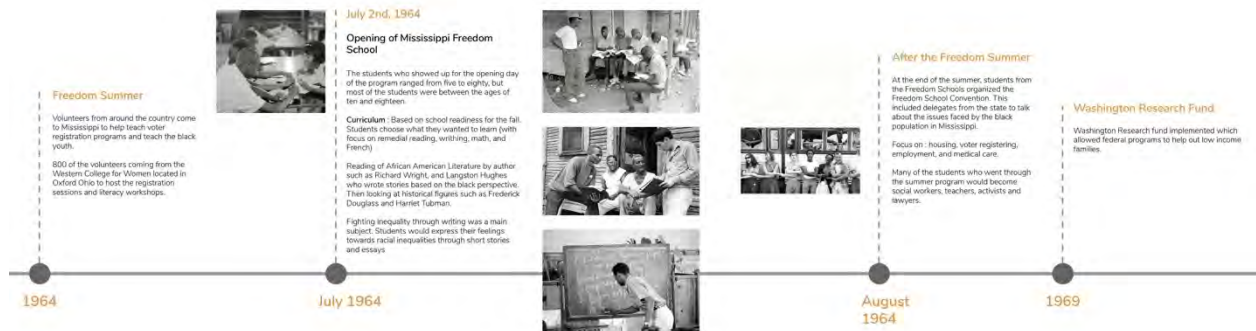

Fig. 1. Segment of timeline based on historical research on Freedom Schools for exercise three during the fall seminar. Research conducted by Charlette Fuss, Megan Owens, and Kaylee Tucker.

FALL SEMINAR

The fall seminar launched with an exercise on research and precedents. Students in teams of four covered topics that related to timber crafting, including anisotropic properties of wood, traditional joinery techniques, fabrication processes such as steam and kerf bending, lamination processes, and preservation treatments such as shou suji ban. Another team researched timber construction types, ranging from traditional post and beam structures, active bending structures, reciprocal frames, and modular timber structures with off-site prefabrication. The last team examined contemporary digital fabrication and computational design processes for timber construction, focusing on works from ICD, ETH, EPFL, and other projects that leverage digital processes for timber construction. Presentations by each team allowed students to engage with more content than if they were to conduct the research alone, enabling them to learn from each other during the first two weeks of classes.

The second exercise, to design and fabricate a wooden chair, sought to link technical skills in computational design, structural analysis, and CNC tool operation. (Fig. 2a & b) The production of a wooden chair allowed the students to acquaint themselves with some of the tools available in the fabrication lab. The chair, as a scaled object, enabled a manageable one-to-one prototyping project with learning objectives that included joint connection detailing, material behavior testing, and design/fabrication issues such as tolerance. Design criteria asked the students to feature specific techniques of fabrication to leverage the wood's behavior, enabling functionality to be integrated with the formal expression. The use of glue was prohibited to emphasize proper joint design. The performative requirement was that it should consider ergonomic design criteria and must support a person seated. During this four-week exercise, students received Grasshopper scripting training since many did not have prior experience with this Rhino plugin. A graphic statics lecture by external guests Ole Ohlbrock and Pierluigi D'Acunto of ETH provided a foundational understanding of structural forces relating to geometric configurations and topology optimization. Lastly, while it was not necessary to use the 3-axis router as a technique for fabrication, all twelve students were trained in anticipation of its use for the rest of the academic year. This included training on using Mastercam to prepare the files for routing. Outside of physical prototyping, most instructions, especially lectures and skill-based workshops were done remotely. Due to Covid-19, it was expected at the time that in-person convergence should be kept at a minimal. Students were allowed to use the shop and fabrication lab through scheduled appointments to prevent crowding.



Fig. 2a & b Kerf Bent Chair by Nicolas Di Donato and Hana Saifullah. (a) Plywood sheet routed with pattern before bending. (b) Final chair.

This approach to fabrication teaching is to invoke a heuristic form of discovery, where designs emerge directly from working with the material more so than focusing merely on students' acquisition of skills to operate the tools or learn the diverse methods to achieve any given result (technique). In this sense, prototyping is key. The prototyping process is usually iterative, testing against a set of concerns that demand adjustments by analytically assessing the next move relative to feedback. In these instances, failures or unexpected outcomes are crucial moments for learning. Developing the ability to advance their work intelligently, the students had to develop many tests, modifying the fabrication technique and weight design decisions against fabrication limitation and material behavior. As such, the students' engagement with craft in prototyping is both intellectual and physical.

The final three-week exercise focused on programmatic elements for design. Four different teams covered topics relating to: 1-the history of Freedom Schools and inequalities in public education, 2-outdoor classroom precedents in terms of architectural requirements, including historical outdoor learning spaces such as Open Air School by Jan Duiker and spatial criteria for learning and health, 3-outdoor learning and educational models including pedagogy, their relationship to outdoor environments, and advocacy for outdoor classroom such as Green Schoolyards America, and 4-contemporary examples and design requirements for outdoor classrooms including timber structures as outdoor classroom spaces. This portion of research prepared the students to ensure programmatic elements are incorporated in the design of the timber pavilion.

WINTER DESIGN STUDIO

The timber construction research conducted in the fall semester was wide-ranging in scale and scope. The pedagogy had to be narrowed to allow the students to focus on specific inquiries that were reasonable based on what could be accomplished in one semester. The approach was to focus on material manipulation for understanding joinery that could be expanded to a timber construction system. Reciprocal framing systems (RF) were chosen for several reasons. First, as a framing system, it is lightweight and typically made of smaller members, usually timber, which aggregate into a larger self-supporting structural system. This made it possible to use CNC equipment that was available in the fabrication lab. The typical reciprocal configurations of small elements (at minimum with three members arranged around a central node resting upon each other without the addition of an alternate material) allow wood members to be the primary focus of design, especially when it comes to joinery. RFs could also be studied using computational

methods, including topological optimization, to explore design variations. (Tai 2012) For the purpose of developing the project in Taubman College's FabLab and then shipping to Chicago, the idea of prefabrication off-site was also manageable with RF systems. To initiate quick prototyping work, the students were assigned to manufacture a RF node using three-dimensional joinery to both get familiarized with RF systems and to explore non-orthogonal jointing connections by using 5-axis milling processes. 2X4s were chosen as the prototyping material since it is widely available, cheap, and offers the opportunity to rethink the use of dimensional lumber outside of balloon framing for single-family homes. (Fig. 3) In the US, 90% of 2X4s are used for domestic homes (based on 2019 data). (Dietz 2020) Spruce-Pine-Fir (SPF) dimensional lumber are often used for stud framing but are covered over with other materials, hiding crafting imperfection and tolerance issues. The opportunity to use one of the most common dimensional lumber to do more than just framing was to rethink what this material could do given new contemporary design and fabrication technology.



Fig. 3. Jointing conditions of reciprocal frame nodes and an example of a double layer reciprocal frame with interstitial members in between as a type of 3D truss frame.

Based on students' research, advantages and disadvantages were identified with this framing system to explore how best to approach the design of a small timber pavilion/outdoor classroom. Geometric configurations in relation to structural load distribution were studied for RF systems. (Parigi & Kirkegaard 2014) (Larsen 2008) (Danz 2014) Based on conversations with Ray Elementary School which included students from K-12 grade level, the exploration ruled out the possibility of a surface that spans from floor to floor as a single or double curved surface (sectionally in the form of an arch). This was because elementary school students could climb the RF structure, making it hazardous when students are not supervised. As such, a planar roof structure was devised, supported by a combination of walls or columns. In order to build a RF spanning structure large enough to encompass at least two small classes (about 59 ft X 35 ft), a new system had to be developed. Taking note of a double-layer RF system explored by Aleksandra Apolinarska from the ETH, the studio focused on articulating an optimized double-layered RF truss system. (Apolinarska 2018) Apolinarska's RF system was designed with butt joints which limits the structure as a strictly planar surface. The studio's approach was to introduce variable thickness to the truss to place material where it is needed most within the sectional depth to direct loading forces to the vertical supports and manage non-orthogonal complex joint conditions with 5-axis milling processes. A series of options were analyzed to understand the limits of 2X4 joint relationships. This includes the number of members to create the interlocking RF nodes/modules, the amount of material that needs to be left after milling the joints, and the customization of geometric configurations that is necessary for an optimized RF surface. (Fig. 4) A quad mesh (all vertices with valence 4) was identified to work well across these different parameters. Additionally, the joints are considered with assembly in mind by including enough space around the nodes to account for screw connections made with a hand drill. This includes understanding the limitation of non-orthogonal screw connections and how best to connect the members in place in terms of directionality, leaving enough material grip where multiple screws are close to each other.

To arrive at the design of the pavilion canopy/roof, a series of iterative studies were done with computational design tools that included the use of scripting with Grasshopper (customizing structural parameters), Kangaroo (physics-based simulation to relax mesh into form), and C# scripting to generate the RF members with joinery intersections. (Fig. 5a) This workflow was recursive for all the design possibilities, especially as the vertical support variations are worked out to account for programmatic and spatial configurations for the classroom use. (Fig. 5b) The programmatic charge was to support two small classes that could occupy the pavilion at any one time, with the flexibility to expand into one large class with smaller conversation areas. Outside of school hours, the classroom could be a performance space to host an audience of about 200 in the park setting where the classroom is sited (across from the street of the school). The final design employed a roof structure shaped in plan as a parallelogram with decking for the floor to be a rectangle, exposing two triangles at the corner.

Reciprocal Frame - Basic Module Iterations

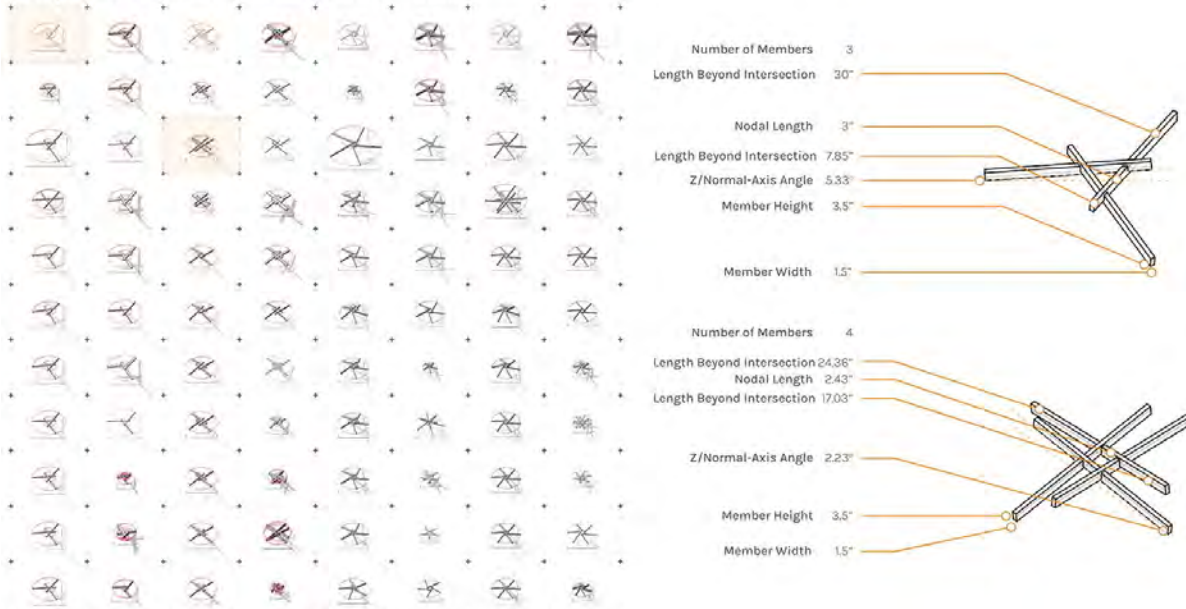

Fig. 4. Variations of 2X4 nodal intersections with two examples highlighted to the right identifying the parameters for the node generation.

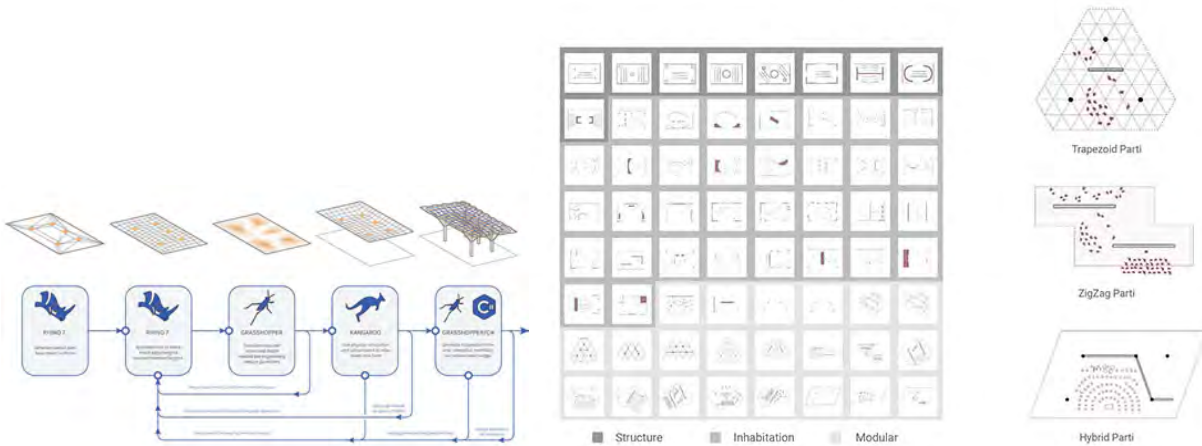

Fig. 5a & b. (5a) Computational workflow and process for geometric and structural analysis. (5b) Spatial configurations based on program and inhabitation.

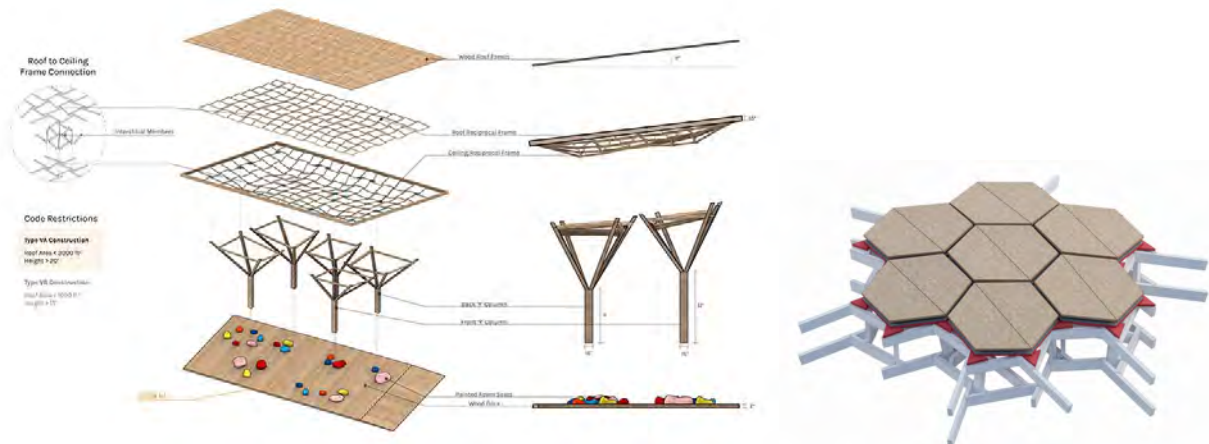

Fig. 6a & b. (6a) Exploded axonometric diagram showing components of the timber pavilion include the layers of the reciprocal frame and Y-column support. (6b) Composed roof cladding unit exploration for weather protection. Top surface can be any type of weather proofing material (cedar, aluminum, polycarbonate).

Y-columns were used to keep the occupiable space flexible. The height of the roof plan, with the underside to be sculpted through optimization, at minimum, had to clear 20'-0" by building code requirements. The current building code for outdoor opened timber structure, being more than 1,000 square feet, had to have 20 ft clearance for fire safety. (Fig. 6a) This was a design limitation that the students had to work with, and the architectural firm's involvement contributed to understanding not only structural calculation requirements for design but also building code standards as contingencies to respond to. Along with other siting parameters and adjustments, the outdoor classroom also included a top layer of cladding for cover over the RF. This allowed the timber to be untreated. The cladding was envisioned to be modular based on the RF geometry that can be assembled off site and attached as roofing as the last element to be installed. (Fig. 6b) Different roofing types were considered including off the shelf cedar and aluminum shingles as well as custom manufactured polycarbonate shingles. The final iteration considered a composed unit that has battens underneath a sheet material that could be pre-manufactured as a unitized system. A polycarbonate top layer was chosen for light filtration for the classroom and edges were to overlap for shedding water based on the directionality of the roof's slope. The cladding was not prototyped due to time limitations.

At this juncture of the studio, the class was divided into two teams to prototype a portion of two full-scale RF systems. The first prototype explored orthogonal RF nodes (controlling the modules of the nodes in terms of length) with the upper RF roof layer to align with the lower ceiling layer, and the interstitial members to bridge diagonally in elevation but orthogonally in plan. (Fig. 7) The second prototype was generated from a mesh in Kangaroo whereby the lengths of RF members were calculated based on structural depth for spanning between columns and cantilevering at the edge, as well as limitations of the members' intersecting joineries. (Fig. 8) In this case, the nodes are offset between the roof and ceiling layer and the interstitial members bridge from node to node between the layers to create the 3D truss. The two prototypes offered the opportunity for comparison and contrast in terms of geometric adaptability to topological optimization, node variations in terms of unique members for fabrication, assembly sequences and fabrication limitations including machining processes that the design had to account for, and registration/alignment features for assembly. The prototyping discoveries were continuously incorporated into the design to manage different facets of fabrication and construction.

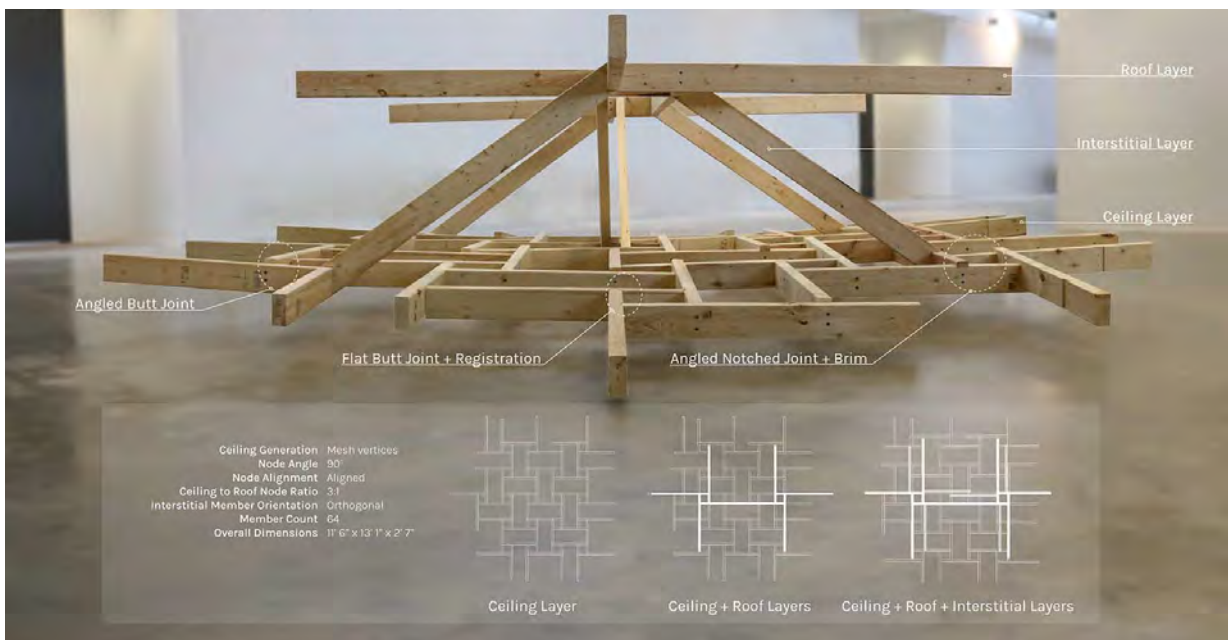

Fig. 7. Reciprocal frame prototype 1 showing relationships between ceiling layer, interstitial layer, and roof layer.

FINDINGS

The study highlighted that in prototype 1, where the modules were identical (which allowed members to be the same), required more modules as it was less flexible for topology optimization. Given that all the members are manufactured through digital processes, the uniqueness is only a barrier if one structure is ever built, allotting more time to program the milling files for unique types. Prototype 2 offered much more flexibility for optimization and is in fact more materially efficiency. The full-scale prototypes offered the students an opportunity to understand how fabrication limitations impact their final design. The fabrication of the prototypes also highlighted the importance of sequence in assembly. Where early joining of a single nodes did not need to account for alignments with adjacent nodes, the final two prototypes developed the sensibility that registration notches were important to reduce tolerance issues that could easily be multiplied as the RFs were being constructed. (Fig. 9) There were questions about the accuracy of milling when it became apparent that the assembly process required all four interstitial members to be in place to find the best fit before fixing in place with screws. Given these tolerance issues, for prototype 2, the assembly was deconstructed and

reconstructed, which resolved the tolerance issues based on alignment. Given the speed in assembly for the final prototypes (actual assembly took one day each), students were able to understand the value of off-site prefabrication to reduce on-site construction labor. While much more work was invested in the design and fabrication process, the ease of assembly as well as the integration of structural and programmatic parameters made frontloading the work worthwhile. For both prototypes, assembly was constructed right side up. While the top layer of the RF is flat, which could allow for the ground surface to be used as datum if assembled upside down, the decision to construct the prototype right side up was to relate to onsite building conditions where the ground may not be perfectly level. A temporary scaffold was necessary to prop the RF up for prototype 2 given that the ceiling layer of the RF is much more drastic in terms of changes in sectional thickness for the roof. For prototype 2, after disassembly, the RF was constructed upside down. This aided the four interstitial members to be in place to form the nodes, enabling tolerance issues to be resolved. Given this method of assembly, a small section of the RF could be preassembled and connected into larger portions on site.

The assembly process for prototype 1 identified that the members could be assembled even faster if registration notches were routed in place to position the intersecting members. The time that is spent on routing registration marks for joints, which adds to the overall routing time for the members, became a point of discussion in relation to time that would otherwise be saved when assembling on-site. It also enabled more accuracy in terms of joint tolerances, preventing joint deviations from multiplying as more members are added. Given the affordance of tighter tolerances and speed of assembly, the time invested in registration notches is preferred. Pilot holes for screws were incorporated to the milling files to ensure alignment and to keep the wood from splitting when screwing the members together. Especially with prototype 2, where the interstitial members are at more acute angles to the roof and ceiling layers, the pilot drilling was a two-step process to prevent the bit from deflecting when drilling into a surface that is non-orthogonal. When the bit was beyond 45 degrees to the surface normal, an added step of starting the hole perpendicular to the face was necessary in order for the bit to catch at the right location for the second step of drilling at the correct angle. The programmed files were generated in MasterCam and the computational simulations were used to check the machining sequence. Once the members are machined, it was discussed that the assembly should take place within no more than two days. This is due to the fact that timber, even though being processed indoors, will warp due to changes in humidity making the jointing alignments out of place. While there is some give to the timber as a material, tolerance was key to making sure the stress transfer of the RF is properly directed.

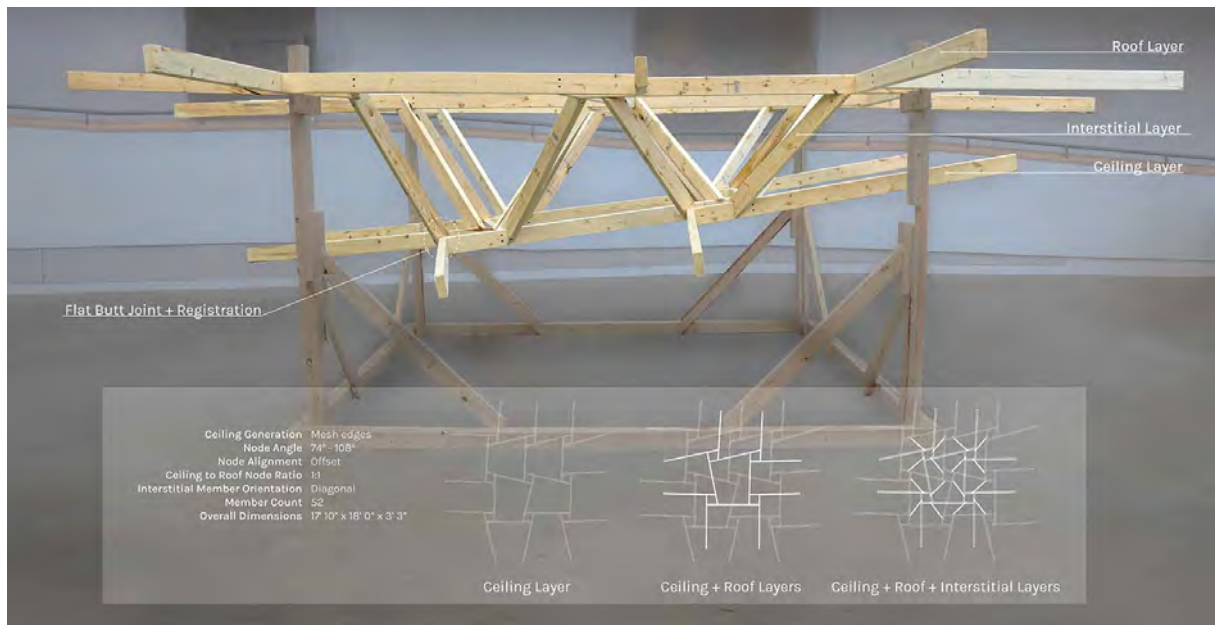

Fig. 8. Reciprocal frame prototype 2 showing relationships between ceiling layer, interstitial layer, and roof layer.



Fig. 9. Images highlight differences in tolerances incurred during the assembly process.

Due to CPS being overwhelmed with students returning for in-person learning in February of 2021, the studio was not able to coordinate an agreement in time for final production and installation. The students had developed a series of community programming workshops aimed to dialogue with different audiences at Ray Elementary. Unfortunately, the workshop did not take place as Ray Elementary was not able to handle external collaboration at that point. While the scope of realizing a pavilion seemed reasonable with twelve students as a group project, remote learning and general fatigue with digital communication exhausted the group. Even though the RFs were not realized, the impetus to explore timber construction with 2X4s continued as a research project between the faculty members and SOM during the summer of 2021.

CONCLUSION

The SOM sponsored studio *Topology + timber* aimed to integrate digital fabrication in timber construction with socially driven design motivations for an outdoor classroom for Ray Elementary School in Chicago. The pedagogy sought to lead students to embrace physical prototyping and experimentation with computational design techniques, working fluidly between different tools, media, and processes. The exploration of the final prototyped RFs highlights the pedagogical significance that design integration is critical for innovative construction systems. Often, digitally fabricated pavilions as demonstrators are criticized for prioritizing aesthetic value or structural performance as singular in its aim without the pushback of program and audience. The comprehensive parameters of users' input, spatial flexibility for the classroom inhabitation, site responses, programmatic drivers, building code requirements, and construction challenges were all carefully considered at different phases of the project. The pedagogy enabled students to apply and link knowledge between material crafting, design, prototyping, and computational analysis in a concise design project that was collaboratively produced. SOM's input, especially for structural analysis, brought a critical dimension to their design process. While what is described here are finished and documented work, the iterative component to prototyping and design saw many revisions and failures. The students, more than learning the techniques (of design and making), also learned to integrate tacit knowledge gained in making with design objectives for the outdoor classroom.

ACKNOWLEDGMENTS

The studio wants to acknowledge SOM for their generous support for the sponsored studio, both through financially and instructional contributions.

The SOM guest instructors: Ryan Culligan, Benton Johnson, Sydney Brown, Kyle Vansice, Rahul Attraya, Megan Mohney, Rishabh Moorjani, and Jonathan Baranowski.

The students in the thesis course: Nicholas Di Donato, Huiting Du, Charlotte Fuss, Nicolas Garcia, Jeong Su Han, Yuhao Huang, Hannah Kirkpatrick, Kyung Ho Lee, Megan Owens, Hana Saifullah, Xingyue Sun, Kaylee Tucker.

REFERENCES

- Apolinarska, Aleksandra Anna. 2018. *Complex Timber Structures from Simple Elements: Computational Design of Novel Bar Structures for Robotic Fabrication and Assembly*. Doctoral Thesis, ETH Zurich. <https://doi.org/10.3929/ethz-b-000266723>.
- Breneman, Scott, Matt Timmers, and Dennis Richardson. 2019. "Tall Wood Buildings in the 2021 IBC." In *Civil and Structural Engineering Media*, May 1, 2019. <https://cseengineermag.com/tall-wood-buildings-in-the-2021-ibc/>
- Chicago Freedom School. Last accessed 11/10/2021. <https://chicagofreedomschool.org/about-us/>
- Danz, Calder. 2014. "Reciprocal Frames, Nexorades and Lamellae: An Investigation into Mutually Supporting Structural Forms." White Paper. Design Machine Group: University of Washington.
- Dietz, Robert. 2020. "How Many Homes are Concrete-Framed?" *National Association of Home Builders*. <https://eyeonhousing.org/2020/09/how-many-homes-are-concrete-framed/>
- Hale, Jon N. (2011) "The Freedom Schools, the Civil Rights Movement, and Refocusing the Goals of American Education." *Journal of Social Studies Research*: 259-276.
- Hinkel, Dan. 2020. "Youth activist organization sues Chicago police, city officials over cease-and-desist order during protests." *Chicago Tribute*, June 25, 2020.
- Kremer, P D, and M A Symmons. 2015. "Mass Timber Construction as an Alternative to Concrete and Steel in the Australia Building Industry: A PESTEL Evaluation of the Potential." *International Wood Products Journal* 6 (3): 138–47. <https://doi.org/10.1179/2042645315Y.0000000010>.
- Larsen, Olga Popovic. 2008. *Reciprocal Frame Architecture*. Oxford: Architectural Press.
- Parigi, D., & Kirkegaard, P. H. 2014. "Design and Fabrication of Free-Form Reciprocal Structures." *Nexus Network Journal*, 16(1), 69–87.
- Tai, Alan Song-Ching. 2012. *Design for Assembly: A Computational Approach to Construct Interlockign Wooden Frames*. Master of Science in Architecture Studies, Massachusetts Institute of Technology, June 2012.
- Thoma A., Adel A., Helmreich M., Wehrle T., Gramazio F., Kohler M. (2019) "Robotic Fabrication of Bespoke Timber Frame Modules." In: Willmann J., Block P., Hutter M., Byrne K., Schork T. (eds) *Robotic Fabrication in Architecture, Art and Design 2018. ROBARCH 2018*. Springer, Cham. https://doi.org/10.1007/978-3-319-92294-2_34

Fabric Formed Poured Earth: Using Urban Site Soils in Fabric to Eliminate Portland Cement

Charlie O'Geen¹, Catherine Page Harris²

¹Kendall College of Art and Design, Grand Rapids, MI

²University of New Mexico, Albuquerque, NM

ABSTRACT: The poured earth process transforms a traditional building material, site soil, with its low embodied energy and low environmental impact, into a material that can be used like concrete, with formwork and a mechanical pouring method (Eid 2018; Gauvin-Muller 2017; amaco 2017), reducing the carbon footprint of the built environment. Only a few countries offer government support for raw earth construction (e.g., France's Cycle Terre), but it could be developed in urban areas across the world to increase the potential of earthen construction systems. Poured earth is commonly stabilized with Portland cement or geopolymers (amaco 2017; Eid 2018) and utilizes conventional formwork to eliminate cracking and to speed drying. Our research tests issues such as: modulus of rupture and compression for fabric-formed site soil and processes for testing and modifying site soils for an optimal range of grain sizes, clay, sand, and aggregate amounts. This article focuses on two methods of analyzing site soils for use in poured earth: jar sedimentation tests and particle size sorting. Secondly, we consider the aesthetic effects of using site soil with fabric formwork. Fabric formwork (West, 2017) mitigates form-tie cracks, accommodates the shrink, settle, and bulge of poured earth, and provides an even drying time across the pour without stabilizers, eliminating heavy additions of embodied energy. Fabric formwork also creates a sculptural wall form that allows the use of site soils by adding clay or aggregates for an optimal mixture. For centuries, earthen construction has remained a backbone of traditional architecture. This project investigates how to continue to shift the language of earth into contemporary urban contexts.

KEYWORDS: Global Sustainability: Mitigation and Adaptation, Design / build research, Unstabilized, Fabric formwork, Poured earth



Figure 1: Detail and context view of Fabric Formed Poured Earth wall mockup installed permanently in Detroit. (Source: Rearick 2020)

INTRODUCTION

This project proposes a terroir or place-knowing (van Leeuwen et al 2020) of building, site materials transformed into spatial organizational elements (walls) to develop a relationship to place. In the era of global climate change, both mitigation and adaptation are required to minimize and live with the already catastrophic effects of human-created

carbon in the atmosphere. One source of carbon, worldwide, is the Portland cement that stabilizes or comprises global construction. Portland cement is responsible for around 8% of carbon dioxide emissions worldwide (Rodgers 2018). To develop a path towards global sustainability, this paper proposes a method to use site soils in fabric formwork without Portland cement stabilization, eliminating transportation of material, the embodied energy of cement, and thus emissions. We propose using urban site soils to coax climate resilience out of the materials of the city itself.

Earthen materials are often considered rural solutions, dependent on ample area to create, e.g., adobe blocks. Urban spaces require workflows and physical arrangements that handle tight spaces, competing uses, limits on material storage, and technological answers, compressing time frames of installation and equipment space. Urban spaces also exist within a complex palimpsest of social and cultural expectations and audiences, not solely contemporary. Traditional methods for earthen building were used around 1000 CE in urban spaces developed by Native Americans such as Taos Pueblo, Jemez Pueblo, and in other sites throughout North America (Dethier 2020). Poured earth (Figure 1 below shows a previous installation by the authors) can bring together this history of earthen materials in urban space by using site soils and fabric formwork to avoid dependence on Portland cement. This article investigates two methods to analyze site soils for use in poured earth: jar sedimentation tests and particle size sorting.

To test the feasibility and aesthetics of our theory, the authors excavated a small 18"x18"x8" void at the Albuquerque Museum in Old Town, sorted the soil by particle size, and then created a site soil mix to pour a small sculptural wall in fabric formwork. The installation acts as a pedagogical tool, with a thick sheet of acrylic as a base that allows views into the excavation and extends under the poured piece. This illustration of the principle of urban site soil reuse as building material is a first gesture towards developing a workflow and vocabulary for this material use; later research will take up the question of the scalability of poured earth construction methods.

1.0 CONTEXT AND LITERATURE REVIEW

1.1. Contemporary building practices

The building construction industry is a complex network of components and resources that are heavily dependent on globalized economies. On-site construction, combining many different materials and trades, is a complicated equation relying on perfect timing and coordination for successful project delivery. A perfectly-orchestrated project composed of components relying on "just in time" delivery is rarely achieved in contemporary construction. Project delays and construction projects finishing over budget are more common than not, especially during the Covid-19 pandemic.

However, recent advancements in project delivery and execution have begun to change the construction industry. Modular construction, which promises to be on time and on budget as it relies on predictable schedules in a controlled environment, has gained in popularity. According to the 2019 Permanent Modular Construction (PMC) Report from the Modular Building Institute, new construction starts for PMCs have increased to 3.67 % of the construction market from 2.43% in 2015. This is an increase of \$5.27B of revenue for PMC firms in North America (Modular Building Institute 2019). This increase could be a key shift in the way that we think about material construction practices moving forward. Yet while off-site-made modular construction has the potential to minimize material waste and embodied energy, the added transportation component could bring the embodied energy back to even with on-site construction.

1.2. Urban building logistics examples

The authors have studied two examples of poured earth as urban building material. One is the *Médiathèque et maison des réfugiés*, Paris 19e, atelierphilippemadec et Nicolas Miessner, and the second is the "Building with Poured Earth" video, produced by amaco (amaco - English channel 2017). In conventional formwork, Fuchs and Müller, part of the consortium "amaco" require 3-5% Portland cement in the soil mix for viability (Gauzin-Müller and Fuchs 2020). *Médiathèque* employs precast panels in poured earth with no cement stabilization on an internal frame and then moved on site (Peyzieu 2010). In contrast to both these approaches, fabric forming means that for non-structural walls, the cracking with conventional formwork is not an issue, and thus the more flexible poured-in-place process can be used.

Poured Earth also allows for conventional pump delivery of material into a form. This workflow is established in the building industry, which allows for adoption in less artisanal circumstances. Muller discusses the need for artisanal skills in order to produce rammed earth (Gauzin-Müller 2020) and that the use of poured earth solves this issue by using skills already common to poured in place concrete construction on urban sites.

A significant cost to new construction in urban spaces is the removal of site soil when excavating for foundations, basements, and utilities. Those soils must be transported via truck to landfill sites. Re-using that soil in the construction eliminates transportation and dumping, both of which are climate change costs. This exploration posits another workflow, wherein site soils become wall forms, thus the construction contains its own detritus.

2.0 MAPPING SOILS

2.1 Analog site-based methods of sorting clay materials from site soils - water and dry

Using site soils requires a means to sort clay from the other materials in the soil. Clarence Cruz, Tewa Potter, teaches students in pueblo pottery at University of New Mexico traditional methods of harvesting clay to make pottery.

The clay soil is brought back to UNM in five-gallon buckets, screened to remove rocks and other debris, then put in water, which allows the clay to settle to the bottom. The clay slurry is then placed in a wooden frame on newspapers and canvas to allow the water to drain. (King 2019)

This water method reliably produces clay particles, but requires much movement of material and water.

The soil jar sedimentation test is a smaller-scale water-based method to articulate soil composition, but not to process large amounts of soil, is explored in this paper as an immediate way to discover amounts of organic material, clay, silt, and aggregates in a soil sample. Earth is put into a jar with a sufficient amount of water to have an inch more water than material; the jar is then shaken and the earth separates and settles (see Figure 5 below).

The dry method explored in this paper uses screen sieves to analyze soil composition by particle size. These sieves from Forestry Suppliers are stacked and soil shoveled in. The sieves are shaken as a group and each layer sorts particles into >4000 microns, >2000 microns, >500 microns, >250 microns, >125 microns, >63 microns and < 63 microns. The material that is < 63 microns includes some silt particles as well as clay particles (see Figure 4 below).

2.2. Urban soil mapping - soils mapping of Albuquerque

As our primary test case, we worked with “A Garden”, an ongoing installation by the University of New Mexico’s Art & Ecology program at the Albuquerque Museum in Old Town. Soil maps of Albuquerque depict a city built on river and alluvial deposits (see Figure 2 below). Sands, clays, and silts create a palimpsest of deposition through flooding, alluvial flows, and aeolian particle movement. Any one area of the city can have multiple substrata. Also present in urban soils are the detritus of occupation, Indigenous settlement, Spanish conquest and recent construction. In the sample excavation for this project, river-worn pebbles, road-base gravel, pieces of asphalt, and shards of glass can be found in the material. The site was once a truck farm for the railroad and the sample installation is in an area where trucks loaded produce. The process of excavating and building with site soil allows for a palimpsest understanding of the history of the site. Urban soils thus provide a material history that elucidates the human and non-human interactions with place.

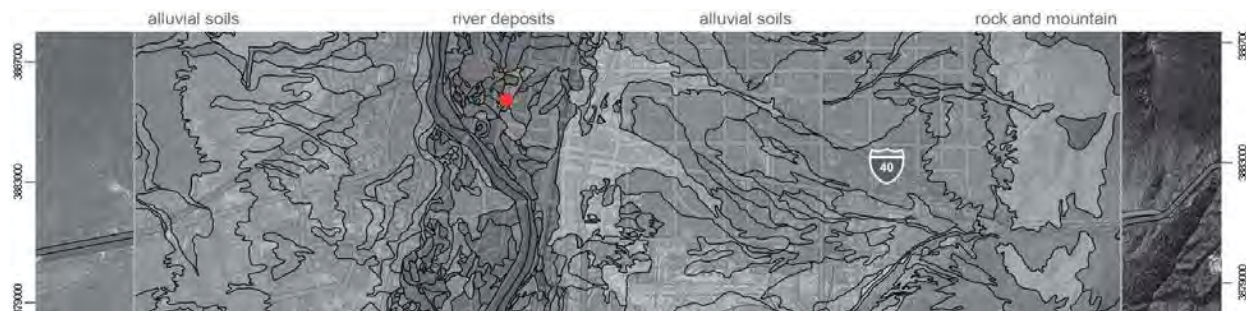

Figure 2: Soil Survey, Albuquerque New Mexico with site area shown in red. (Source: Authors 2021, modified from <https://websoilsurvey.nrcs.usda.gov/app/WebSoilSurvey.aspx>)

3.0 METHODS

3.1 Introduction: site sculptural installation

Raw earth is commonly a mix of organic matter, aggregates, (including sands), silt and clay (Forestry Suppliers 2021). Construction mixes of earthen materials do not include significant organic matter, although fibers added to adobes and poured earth mixes are often hays or other plant fibers, and thus include specific organics (Gauzin-Muller and Fuchs 2020). Site soil harvesting needs to avoid top soils with high organic content to avoid including seed banks, which might germinate, organic material, which might rot, or significant microbial and mycorrhizal life, which are decomposers and nutrient recyclers. The optimal mix so far determined by Poured Earth Collaborative (PEC) testing is 52% aggregate, (with one-third of that being sand), 18% water, and 30% clay (all by weight) with a small percentage of fiber added to the mix, roughly 1% by weight (see Table 2 below). In PEC’s previous research, these elements were purchased, rather than used from a specific site, to provide a consistent testing environment for our focus on the interaction of soil mix and fabric forms. The project described in this paper applies our earlier research with consistent, purchased, materials to the variability of site materials. We worked with the material proportions in the soil found at The Albuquerque Museum “A Garden,” a collaboration with Art & Ecology, on Mountain Rd. in Old Town, Albuquerque (see Figure 3 below).



Figure 3: Albuquerque Museum sculptural installation showing formwork, final pour with acrylic covered excavation and detail of surface and detail of agave fiber in mix. (Source: Authors 2021)

3.2. Site soil excavation and sieving for sculptural installation

Site soils are conventionally excavated for building foundations and to level sites. PEC tested using site soil from an excavation at the Albuquerque Museum to pour a poured earth sculptural installation. The soil was excavated in an 18"x18"x8" hole. A jar sedimentation test said the material was 5% organic, 12% silt/clay, 33% sands, and 50% of it was aggregates. The soils were then sieved into particle sizes to determine their classification. Soil constituent materials can be identified by their particle size: Agg. > .2", Sand .05-.2", Silt .002-.05", Clay <.002. Our sieves approximated these categories. By sieve, 6% was silt clay, 36% was sands, and 57% was aggregate with some organic included.

The testing, sorting, and mixing method developed for site soils must take place on site to minimize the carbon impact of building and to fully understand the terroir of the building materials. PEC seeks to develop a workflow with no embodied energy save that of the labor to process and mix the material on site. In the urban context, this is not limited to material considerations. Time spent on site also allows for curious passers-by to interrogate the process of sorting through the layout of piles; and it allows contemporary and site-specific concerns expressed in the streets to impact the process. For example, the Landback protest on Indigenous People's Day marching through the streets contrasted with our project's Enlightenment analytical methods of particle sizing (see Figure 4 below, Landback protest pictured far right).

3.3. Site soil particle size analysis for site material for sculptural installation

For this project, we used a graded sieve set used by forestry experts to identify soil types in the field. Particles were screened with 5 mesh (4,000 microns), 10 mesh (2,000 microns), 35 mesh (500 microns), 60 mesh (250 microns), 120 mesh (125 microns), and 230 mesh (63 microns) screens (see figure 4 below). This resulted in a silty clay rather than a completely pure clay. By weight, 9 lbs. of the excavated material was determined to be in the range of clay and silt particles, 50 lbs. of material was determined to be in the range of sands, and the final 78 lbs. was in an aggregate scale and above. A significant portion of the large aggregate is urban detritus, concrete, brick, and glass.



Figure 4: On-site soil particle analysis. Source: (Authors 2021)

The particles were then mixed by dry weight into the PEC formula with one mix created completely from site excavated materials and the second mix adding 27 lbs. of Hawthorne clay to create the optimal mix. Both mixes had agave fibers added to form a binder from a native, non-irrigated plant. The Hawthorne clay is excavated at some distance and travels to New Mexico via truck, adding embodied energy, but all aggregates and sands came from the site.

3.4. Site soil mix for sculptural installation with additions based on amounts of materials

Table 1: All site soil mix vs. Site Soil + off-site clay log. (Source: Authors 2021)

All site soil mix	weight (lbs.)	Site soil + off-site clay	weight (lbs.)
silt and clay particle sizes	09.0	<i>Hawthorne Fire clay 35 mesh</i>	27.0
site sand	03.9	site sand	12.0
site aggregate	11.7	site aggregate	35.0
water	05.4	water	16.0
	30 lbs. total		90 lbs. total

The table above shows the amounts of particle size sorted material from the site, as well as the mix the authors used, which was determined by earlier PEC testing to be optimal (30% clay, 18% water, 52% aggregates - divided into 25% sand and 75% aggregates above ¼" in size). The first column shows the site soil mix with no added clay. Two considerations emerged in our process of mixing and hydrating site materials for pouring: First, after a week of soaking, the site soil mix had a gaseous smell indicating organic materials in the mix. The second mix, with Hawthorne clay added, did not have any odor after the week of soaking. In future testing, silt should be removed altogether to avoid incorporation of organic materials. Second, soil dampness, despite the dry climate of New Mexico, added to the difficulty of sieving clay out of a raw material. Clay may also be present in larger aggregate sizes, clinging together and creating a pebble-like form. In future testing, the materials may be sieved on site and then soaked to put clays into suspension before it is dried and mixed into the by weight formula for poured earth.

4.0 Parallel testing - technical and empirical inside and outside New Mexico

4.1. Structural capacity: Non-site soil compression testing with various reinforcing results

In parallel with the sculptural installation, the Poured Earth Collaborative (PEC) comparison tested compression strength of the PEC standard mix with different organic fiber additives in the standard "+Clay" mix using a lab compression test. Previously, the PEC tested several mixes with different percentages of decomposed granite (D.G.) used as aggregate, clay, and water. Each mix was evaluated for pourability, durability, and shrinkage. The favorable proportions of these components, a mix we called "+Clay", are outlined below in Table 2. However, because of the reduced number of components in the mix, there was a great deal of separation in the grain size distribution (Minke 2006). We then poured test blocks of our "+Clay" mix with ⅓ of the aggregate being sand instead of it all being decomposed granite. Proportionally, we aligned the grain size distribution with that of a conventional concrete mix having roughly ⅓ fine aggregates (usually sand) and ⅔ coarse aggregates. Fibrous tensile reinforcement, both organic and non-organic, was incorporated in an attempt to make the mixes stronger. While the incorporation of ⅓ sand and fibers was a significant improvement in overall strength as shown in Table 2, the mixes still fall short of being "qualified soil" per the New Mexico Earthen Building Code, which is the only code in the United States specific to earthen construction (NM Building Code 2015). Eventually, PEC strives to make a site soil mix workflow that produces a material that can be certified by NM Earthen Building Code.

Table 2: Poured earth mix components log with reinforcing elements and compression testing results. (Source: Authors 2021)

Mix Name	Sand (lbs.)	D.G. (lbs.)	Total agg. (lbs.) = 52%	Clay (lbs.) = 30%	Water (lbs.) = 18%	Total (lbs.)	Reinforcing Material	Load Held (psi)
+Clay	0.0	35.0	35.0	20.0	12.0	67.0	NONE	<75.00
+Clay w/ ⅓ sand	11.5	23.5	35.0	20.0	12.0	67.0	NONE	118.68
+Clay w/ ⅓ sand & straw	11.5	23.5	35.0	20.0	12.0	67.0	Straw	123.84
+Clay w/ ⅓ sand & fibers	11.5	23.5	35.0	20.0	12.0	67.0	Conc. fibers	098.04

4.2 Extrapolation of soil suitability across North America: Social soil map

The jar sedimentation test for soil composition can be seen as a rough guide to the amount of alteration needed for site soils to become the optimal poured earth mix. As in the sculptural installation example above, the jar sedimentation test can be a good first step to estimate the amount of amendment required to arrive at an optimal mix. To understand the applicability of the site-based fabric formed poured earth building process across North America, the authors devised a Social Soil Map method. We mailed a jar marked with volumes, a piece of recycled denim moving blanket as backdrop, and a set of instructions to family, friends, and friends of friends. The participants were instructed to dig a hole below 6", extract a cup of soil, and shake it with to a specified amount of water to perform a soil jar sedimentation test (Minke 2006) on their local soil (see Figure 5 below). After 24 hours, each participant sent an image of their soil test showing layers. In many cases another image was sent after several days as not all samples settled out to clear water. Some samples were photographed after a week and still had not reached clear water.

This grid provides an image of soils in North America created by a network of people in urban and non-urban spaces. We anecdotally observed that people involved talked about their soils and differences among samples. These 24 samples expanded general awareness of soil compositions, increasing a sense of terroir for participants. Additionally, participants posed questions about where soils come from in urban spaces, since soils move in construction and filling in marshy or low-lying areas, where urban centers tend to be located. This grid images soils across North America.



Figure 5: Social Soil Map. (Source: Authors 2021)

5.0 Fabric-formed poured earth

5.1. Fabric forms and concrete

A final consideration in our project is the aesthetic potential of poured earth in fabric forms. Fabric formwork was popularized by Mark West’s extensive research within concrete casting systems, although West was not the first to use this method. West’s work foregrounded the fact that concrete is a liquid building material and that its plastic potential

is rarely realized in conventional construction. Normally, concrete is cast into rectilinear forms, whose geometry follows the linear and planar conventional building materials that it is made from (West 2017).

Like concrete, poured earth is a liquid and flexible material after it has properly hydrated. Concrete and poured earth also have very similar properties during the casting process. Both materials can be moved on the construction site using the same equipment (shovels, buckets, and pumps depending on the scale) and need to be vibrated to remove small air bubbles. Identical formwork rules relative to the elimination of undercuts, eased edges, coplanar termination edges, horizontal strength, etc. exist between the two materials.



Figure 6: Side by side comparison of standard wood formwork (left, with resultant slumping) and fabric formwork (center, no slumping because of even drying). Forms removed after two weeks. Detail of water escaping fabric at right. (Source: Authors 2021)

5.2. Fabric forms and poured earth

However, the similarities between concrete and poured earth end a few hours after the casting of each material. Although not fully cured for 28 days, concrete rapidly gains strength in the immediate hours after the cast and can be used, in most cases, a few days after the initial casting. This acceleration is due to the inclusion of Portland cement in the mix. While the Portland cement is necessary to achieve high strength and faster setup, it is also responsible for around 8% of global greenhouse gas emissions. Alternatively, poured earth does not contain environmentally damaging additives, and therefore takes several weeks to dry. During this time, the material moves; it shrinks, settles, and cracks. Fabric formwork is the ideal pairing for poured earth because it is malleable and can move with the material. It also provided built-in flexibility for settling and space to shrink in. These materials work together in a symbiotic relationship. The conventional rectilinear formwork with standard form ties does not work for this material. The form ties do not move with the material when attached to a conventionally static formwork, as they do when hung between sheets of fabric. Ultimately this means that the fabric formwork is listening to and following the intrinsic material properties of poured earth. These material properties are not being ignored; the material is not being forced to do something that it inherently does not want to do. Rather, it is allowed to move as it would like to, to be itself, and to honestly record its movement and its casting method permanently in its final shape and texture.

In conventional formwork systems, unstabilized poured earth dries in the upper parts of the pour in a matter of weeks but remains ductile for much longer in the bottom areas of the form and cracks at the form ties. With fabric formwork, these issues are alleviated without stabilizers. Figure 6 shows a comparison test with the same material in rigid plywood formwork and in a fabric form. On the far right, water beads from the fabric formwork. Both forms were removed after two weeks of drying time. The plywood form piece subsequently slumped, whereas the fabric block remained upright.

Our ultimate goal is to articulate a mix design that allows us to use materials directly from the site, replicating the honesty and simplicity of the material components. When processed on site immediately before use, the components are not transported, are not imported, and therefore are the site. The material contains the memories of the site history, from the glacial remnants of sedimentation to cultural detritus in the topping soils from human occupation. The site materials, after being exhumed from underground, are installed permanently above ground as a historical palimpsest. Questions of context-based camouflaging with conventionally mass-produced materials are transcended when the material movement from extraction to use is measured in feet and hours instead of miles and weeks (or perhaps months and years considering our current trade and pandemic predicament).

5.3. Aesthetic language

The language of a wall: Fabric Formed Poured Earth shifts the language of wall in significant aesthetic ways. A wall, here, is not a substrate, a least-expensive and most fireproof definition of space made from commodity products – wallboard, aluminum studs, and fasteners. Instead, FFPE is a wall with its own intrinsic definitions, an object with its own language of settling, bulging, stretching and shrinkage. This wall is infill, rather than structure. It has a significant thermal mass, but more than its construction language, it also speaks an aesthetic language of place – the soil from outside becomes the definition of inside – the wall that separates and protects. Walls define space and use, whether interior to a building or defining exterior rooms, as in Halprin's FDR memorial (Halprin 1997).

CONCLUSION

To summarize: this project used site soils from Albuquerque, testing the particle size method for analyzing and measuring soil composition, and building a small sculptural installation. The authors noted that in particle size methods, clay particles are lost to adherence to differently-sized particles, so further investigation will pair particle size analysis with traditional soaking and filtering to retrieve all the clay available. Further research will also investigate the scalability of site-soil-based poured earth construction. The flexible fabric formwork used for this project allowed the poured earth to shrink and settle such that a Portland cement stabilizer was not necessary thereby reducing the carbon footprint of the material, and building greater climate resilience into urban construction practice. Beyond its potential to reduce the carbon footprint of building, the site focus provides palimpsest information about the history of the site, including shards of materials and experiences of human and social uses. Fabric-formed poured earth from site-based soils is feasible for use in construction processes and provides tactile knowledge of place.

ACKNOWLEDGEMENTS

Many thanks to our families, friends, and friends of friends for digging holes in their backyards and being patient.

REFERENCES

- amaco, 2017. CONSTRUIRE EN TERRE COULÉE, FORMATION PROFESSIONNELLE, 17, 21, activities report amaco - English channel. 2017. "Building with raw earth - poured earth."
https://www.youtube.com/watch?v=gSJKaA0zg_s
- CRATerre. <http://craterre.org/recherche/>, accessed January 21, 2021.
- Dethier, Jean. 2020. *The Art of Earth Architecture: Past, Present, Future*. Princeton: Princeton Architectural Press
- Eid, J. 2018. "New construction material based on raw earth: cracking mechanisms, corrosion phenomena and physico-chemical interactions." *European Journal of Environmental and Civil Engineering*, VOL. 22, NO. 12, 1522–1537.
- Forestry Suppliers. Date unknown. "Screen Sieves Manual."
https://www.forestry-suppliers.com/Documents/1683_msds.pdf, accessed 08/20/2021
- Gauzin-Müller, D., Fuchs, M. 2020 *construire en terre coulee: une revolution?* D'architectures 278 – Mars '20, 46-67.
- Halprin, Lawrence. 1997. *The Franklin Delano Roosevelt Memorial*. San Francisco: Chronicle Books.
- Jojola, Theodore. 2016. "Back to the Fundamentals." *American Artscape Magazine*. No. 3 In Pursuit of the Creative Life, <https://www.arts.gov/stories/magazine/2016/3/pursuit-creative-life/back-fundamentals>
- King, Mary Beth. 2019. "Native American artist teaches traditional methods of making Pueblo pottery." *UNM*, November 4, 2019. <http://news.unm.edu/news/native-american-artist-teaches-traditional-methods-of-making-pueblo-pottery>
- Minke, Gernot. 2006. *Building with Earth: Design and Technology of a Sustainable Architecture*. Basel: Birkhäuser.
- Modular Building Institute. 2019. "2019 Permanent Modular Construction Report."
<https://www.modular.org/documents/public/images/2019-PMC-Report-reduced.pdf>
- NASA and Bradley University. 2017. *On-Site Habitat Competition Rules, Version 3.0*.
www.bradley.edu/sites-challenge-assets-documents-3DPH_Phase_3_Rules-v3.pdf
- New Mexico Earthen Building Materials Code. 2015. Title 14, Chapter 7, Part 4.
- Peyzieu, Jean. 2010. *Le Domaine de la Terre*. M.P.F. number 176 - 2T.
- Rodgers, Lucy. 2018. "Climate change: The massive CO2 emitter that you may not know about." *BBC*, December 17, 2018. <https://www.bbc.com/news/science-environment-46455844>
- van Leeuwen, Cornelis, Jean-Christophe Barbe, Philippe Darriet, Olivier Geffroy, Eric Gomès, Sabine Guillaumie, Pierre Helwi, Justine Laboyrie, Georgia Lytra, et al. 2020. "Recent Advancements in Understanding the Terroir Effect on Aromas in Grapes and Wines: This Article Is Published in Cooperation With the XIIIth International Terroir Congress November 17-18 2020, Adelaide, Australia. Guest Editors: Cassandra Collins and Roberta De Bei". *OENO One* 54 (4):985-1006. <https://doi.org/10.20870/oeno-one.2020.54.4.3983>
- West, Mark. 2017. *The Fabric Formwork Book: Methods for Building New Architectural and Structural Forms in Concrete*. New York: Routledge.

Employing Topology Optimization for Establishing Design Variability in Precast Façade Panels

Niloufar Emami¹

¹University of Illinois at Urbana-Champaign, IL

ABSTRACT: A hallmark of the industrial revolution was standardization in production, while the digital age is characterized by variation and non-standardization. The ability to create variation in degree and kind will not only be an aesthetic driver but potentially will enable us to shape projects specifically for programmatic need, structural capacity, and material properties. Nonetheless, the discipline of architecture has increased awareness of the environmental impact of material use and production methods, which has shifted attention to repeatability and reusability, material waste, material CO₂ emissions, and other involved factors such as labor. This shift is more pronounced in the design and fabrication of concrete elements used in building envelopes since both material and mold design can impact the environment. As a result, customized repetitive manufacturing (CRM) is well suited to address today's design needs for achieving complexity and variability while considering standardized fabrication methods and processes. This research study focuses on the design of precast elements used in facades. It first classifies design variability in architectural panels based on a survey of sixteen built precedents. With this classification, the design of panels is critically evaluated to save on materials using computational design methods, namely topology optimization. Topology optimization is used to determine the placement of openings considering the structural performance of the panels. The tools used for design include Rhino, Grasshopper, and a plugin for topology optimization. The CO₂ emissions of panels with different porosities are assessed to understand the relation between surface area of concrete panels and their environmental impact. The results of this study demonstrate innovative design approaches for precast panels used in building envelopes to save on materials and to reduce greenhouse gas emissions.

KEYWORDS: Digital design and practices; topology optimization; volumetric elements; facades; precast concrete.

INTRODUCTION

The curtain walls, inspired by wartime technical advances, were developed in 1950s in the United States by collaborations among architects, engineers, manufacturers and developers motivated by the desire to create a more economically efficient system with a progressive image (Rohan, 2011). However, the glossy, reflective surfaces of the curtain walls was questioned and lampooned by critiques, calling it "Graph paper architecture" (Rohan, 2011). In opposition to the glossy surfaces of curtain wall facades, concrete, a material whose plasticity and opacity lends itself to expressiveness, was a viable alternative. Architectural precast concrete panel emerged as a new concept in the field of precast concrete in the early 1960s. The architectural panel was used both in bespoke and large commercial projects, unlike the first panels produced in post-war Europe (Etxepare et al., 2015). The architectural panels were designed to hold mullions for glazing, such as in the works of Marcel Breuer's (Etxepare et al., 2015), which were then transformed into sculptural and volumetric elements installed on facades. Examples of using volumetric elements in facades include American Cement Building's facade in Los Angeles designed by Malcom Leland (Culver et al., 2016), IBM building in Honolulu by Vladimir Ossipoff (Liverman, 2008), Wellbeck Car Park by Michael Blampied & Partners (Prynn & Price, 2019), City Hall of Chemnitz by Rudolf Weißer and sculptor Hubert Schiefelbein (Grindrod, 2018).

The use of precast modules in building envelopes has evolved into today's architecture using either concrete or alternative materials. The Broad Museum designed by Diller Scofidio + Renfro Studio shows its departure from the 1960–70s precast facades (Stoughton, 2015). The use of computational and parametric design tools has allowed designers to design complex and non-identical elements for façades (Culver et al., 2016) while advanced fabrication techniques such as CNC milled and 3D printed formwork are affecting the way they are fabricated. It has become apparent that the discipline of architecture is becoming more aware of the environmental impact of material use and production methods, which in turn shifts the focus to repeatability and reusability, material waste, material CO₂ emissions, and other involved factors such as labor. Cement is considered a material with high CO₂ emissions. It is crucial to rethink the way that concrete building elements are designed and used in today's buildings. The larger framework of this study is to do more with less by designing precast panels with the goal of placing material where it is needed in order to conserve materials. The study also focuses on variability and repeatability. Limiting variability and emphasizing on repeatability of designed panels is a key consideration towards saving on materials and production methods.

Thus, this study proposes an advanced method namely topology optimization for designing the precast panels used in facades. Topology optimization is a rapidly expanding research field that has practical applications in the manufacturing

(Rozvany, 2009). Topology optimization allows a structural form to be shaped according to the flow of forces within to achieve a more efficient structural form (Shepherd & Pearson, 2013). This method has been employed in many design problems at different scales. Examples include designing a slab (Dombernowsky & Søndergaard, 2009) (Jipa et al., 2016), a high rise building (Gomez et al., 2020), framing for building envelopes (Paoletti & Nastro, 2018), cable bracing for the hanging steel façade (Richardson et al., 2013), and the cross-section of the PV panel connection to a secondary structure (Lu et al., 2017). Porous panels used in facades can largely benefit from topology optimization to make design decisions on the perforation ratio and material distribution of the panels to achieve highest strength with less material use. In this study, topology optimization is employed to inspire designers on the material distribution in façade panels based on the forces caused by connection types.

1.0 METHODOLOGY

The paper is organized by presenting a precedent analysis in section 1.1. Sixteen precedents were studied with a focus on the grid and geometries of precast panels used in facades. Following an understanding of how the panels differ in terms of their porosity and how they may be connected to a supporting structural system, the research asks how the connections can affect the porosity of the panels. To answer this question, first, the connection of the panels to the underlying supporting structural system was categorized into five main types. Next, section 1.2 demonstrates 2-dimensional (2D) topology optimization used to arrive at panel forms for every categorized connection type. In addition, an exploration was conducted that evaluates how prioritizing tension versus compression in topology optimization affects the computed geometries. In Section 1.3, these retrieved forms are critically evaluated for their environmental implications, namely CO₂ emissions, when used in building envelopes. The last section summarizes the results and discusses the future direction of the work.

1.1. Case Study Analysis

In order to better understand the current use and practices in designing and fabricating the architectural and volumetric panels, sixteen precedents were selected and analyzed in detail. The selection of precedents was based on a set of criteria:

- The panels were fabricated from a castable material.
- Some level of design complexity was present in the project. Example of design complexity included a varied distribution of volume in a panel rather than being flat.
- The buildings were constructed between 2010 and 2020.

Among the sixteen precedents, *seven* were in Europe, *five* were in USA, *two* were in South America, *one* was in Australia, and *one* was in East Asia. The list of precedents that were analyzed are presented in a chronological order in Table 1.

Table 1. List of precedents that were analysed.

	Name of the project	Year of completion	Location	Architect	Fabricator/ Precaster
1	Office Building and Logistic Center	2011	Naples, Italy	modostudio	Canova Prefabbricati
2	Perot Museum of Nature and Science	2012	Dallas, Texas, USA	Morphosis	Gate Precast
3	Extension Railway Service Facility	2013	Harden, Switzerland	EM2N	Betsinor Composites
4	Florida International University (FIU) science Complex	2013	Miami, Florida, USA	Perkins + Will	Gate Precast
5	The Mucem Museum	2013	Marseille, France	Rudy Ricciotti (in association with Roland Carta)	Ductal
6	Neutrabuilding	2014	Jena, Germany	Wurm + Wurm	NA
7	Italy Pavilion	2015	Milan, Italy	Nemesi Studio	Styl-Comp
8	Le Verona Building	2015	Saint-Denis, France	Wilmotte & Associates	TechniMoulage
9	The Broad Museum	2015	Los Angeles, California, USA	Diller Scofidio + Renfro	Willis Construction Co. Inc.
10	Las Americas Social Housing	2016	Leon, Mexico	SO-IL	NA
11	North Residential Commons	2016	Chicago, Illinois, USA	Studio Gang	International Concrete Products Inc.
12	Nike Flagship	2017	Miami, Florida, USA	Touzet Studio	Ductal
13	National Archives	2017	Mitchell, Australia	May + Russell	Bianco Precast
14	Kolon One & Only Tower	2018	Seoul, Korea	Morphosis	FACO
15	Egaligilo Pavilion	2019	Mexico City, Mexico	Gerardo Broissin	NA
16	La Alqueria Market	2019	Seville, Spain	SR Arquitectos	ULMA Architectural Solutions

All the case studies were drawn in a CAD software, and multiple aspects of their design were scrutinized. It was recognized that some panels were completely *solid* acting like cladding, whereas some panels were *porous* allowing daylight into the interior spaces. Some projects had a combination of both solid and porous panels. All precedents except Kolon One & Only One project (number 14 in Table 1) which was an exception since the volumetric elements were not used for ‘paneling’ per se. Instead, the solid elements had a non-orthogonal boundary and were offset from the glass façade of the building to allow daylight into the space.

Looking at the global geometry of the panels and the placement of perforations, it was realized that in porous panels, perforations were always placed according to the connection of the panel to the supporting structure. This is a very practical approach as the connection details are always concealed behind the solid portions of the porous panels. According to this observation, the underlying grid for panel propagation was identified as an important design factor. With a focus on connection placement of the panels connecting to the supporting structure, it was identified that the underlying grid for propagating the panels may or may not align with the geometry of the panel itself. As an example, for some panels both the base propagation grids and the panel’s geometry were square, thus aligning the grid with the panels, whereas for some panels the base propagation grids were square with Trapezius shaped panel’s geometry (Figure 1). It should be noted that the underlying grid for panel propagation in all selected precedents in the presented research were either square or trapezium.

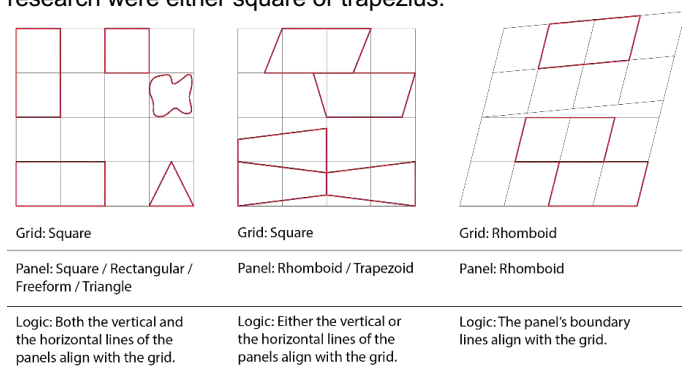

Figure 1. Underlying grid and panel propagation logic based on precedent study.

Studying the underlying grid for propagating the panels and the panel geometry led to categorizing precast façade panels based on their connection to the supporting structural system. The connection mechanisms (Figure 2) include:

- i. ‘Corner point connections’ that align with the geometry of the panel; and are either placed on the boundary of the panels or are offset inward.
- ii. ‘Perimeter point connections’ placing point connections anywhere on the perimeter of the panel.
- iii. ‘Parallel perimeter rails,’ where horizontal or vertical linear support systems are designed to connect the perimeter of the panels to the structural system.
- iv. ‘Frame’ support on the perimeter of the panels which aligns with the propagation grid.
- v. ‘Inner linear supports’ creating support on linear rails that are offset inward.

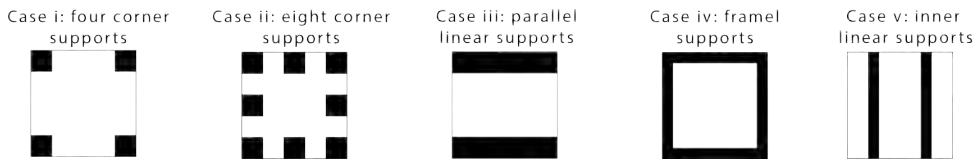

Figure 2. Different support positions for precast panels supported by a structural system.

The above categorization suggests that there are various mechanisms for connecting one assembly to another, which has implications on the way that forces are transferred from one assembly to the other. In other words, the ‘boundary condition’ of the panels are affected by the placement of support points used for connecting them to a structural system. During designing of the panels, the boundary conditions might be imposed to the panel after determining the panels’ geometry and porosity. This approach can be flipped by considering the connection placement first and finding a form that best performs under that boundary condition. Topology optimization is well suited for this design approach. Next section reviews topology optimization method employed for finding a porous form for the façade panels according to their boundary conditions.

1.2. Topology Optimization

Rhinoceros, Grasshopper, and TopOpt plugin for Grasshopper were used for computational design and evaluation processes. The TopOpt plugin for Grasshopper offers basic 2D-optimization (Aage et al., 2013). Briefly, topology optimization can be summarized as a process in which a surface or a volume is discretized, or subdivided, into a number of Finite Elements (equivalent to pixels in 2D and voxels in 3D). Each Finite Element is capable of varying its

material density from low to high densities, which can be interpreted as choosing between two (or more) materials, e.g. void and solid (Aage et al., 2013). TopOpt does not yet support interactive visualization of the ongoing optimization procedure, such as found in the TopOpt application.

a. General Model Setup

Model setup includes identifying a ‘design space’ or domain, which is the surface or volume defining the outer boundaries for the optimization process. Optionally, void or solid regions can be defined which remain constant during the optimization. It also requires a ‘load’ or a number of loads for which the domain is optimized. In addition, it requires a ‘number of supports’ specifying where the domain is supported or fixed. Optimization settings require setting a ‘volume fraction’ specifying how much material is globally available for redistribution within the design domain. Finally, a minimum length scale, ‘Rmin’ sets a minimum size for the features in the optimized design. Following these inputs an iterative process is initiated in which a Finite Element analysis is performed on a domain based on a starting guess (an even distribution of material) and the material is redistributed accordingly, after which the process is repeated until convergence is achieved.

b. Topologically Optimized Panel Configurations Based on Volume Fraction

According to the five types of connections identified in the previous section, five square panels with different boundary conditions (support conditions) were designed. These boundary conditions include:

- i. A square panel with four ‘Corner point connections.’
- ii. A square panel with eight ‘Perimeter point connections.’
- iii. A square panel with horizontal ‘Parallel perimeter rails.’
- iv. A square panel with a ‘Frame support.’
- v. A square panel with ‘Inner linear supports.’

The panels measure 100 cm by 100 cm in the x-y plane. No thickness was given to the panels since 2-D topology optimization only required a planar design domain. In addition, the 2-D topology optimization engine required the applied forces to be in the plane of the design domain. Therefore, façade panels were analyzed only under gravity load (applied in negative-y direction). TopOpt plugin does not require specific assignment of materials; it requires a definition of the main structural action for the structure (compression versus tension action) based on which the material distribution is optimized. The panels used a single-material optimization algorithm that does not have any preference for tension or compression. Each panel type is topologically optimized at 0.7, 0.5, and 0.3 volume fraction ratios for a total of fifteen topologies. Figure 3 demonstrates the configurations of the panels retrieved under different simulation setups. The icons on the top row represent the boundary conditions for the found form which includes support points and the applied load. Looking at the computed topologies, black represents solid and white represents void in each panel. In the next section, performance of these panels is assessed.

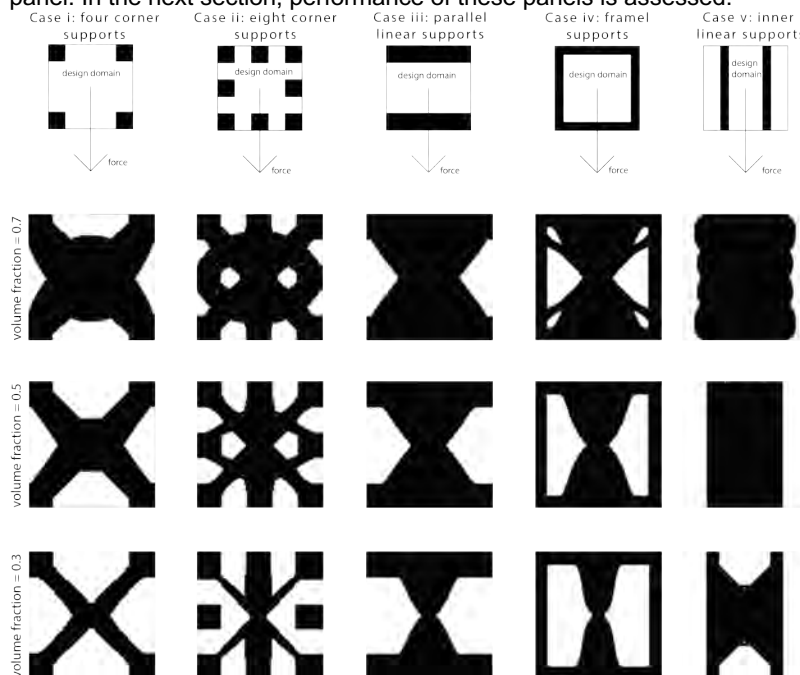

Figure 3. Topologically optimized square panels under gravity load using various boundary conditions (black represents solid and white represents void).

c. Topologically Optimized Panel Configurations Based on Compression and Tension Action

In the next phase of experiments, an optimization algorithm was employed, which allows for tension and compression prioritizations for designers. The algorithm still distributes a single linear-elastic, orthotropic material. It only enables designers to consider materials with superior properties either in tension or compression. The resulting forms will have material implications meaning that a form suited for a material that is strong in compression may differ from a form appropriate for a material that works equally well in compression and tension. For this exploration, all other settings, such as support conditions and volume fraction, are unchanged. This is an appropriate experiment for reinforced concrete as it can relate to varying fiber reinforcements in a homogeneous mix.

Case i with four corner supports with a volume fraction of 0.7 was selected to explore this feature. Changing a preference of tension versus compression can be done on a continuous range with limitations on the end. **Figure 4** illustrates typologies that were created with a priority on tension action. The typology on the far right demonstrates the maximum amount of allowed tension preference. All other settings such as supports and volume fraction are constant among the typologies. Looking at the optimized forms, the distribution of material is slowly swayed away from the center and moves towards the top of the panel. **Figure 5** illustrates typologies that were created with a preference for compression action. The typology on the far right demonstrates the maximum amount of allowed compression preference. More material is distributed at the bottom of the panel in this mode of computation.

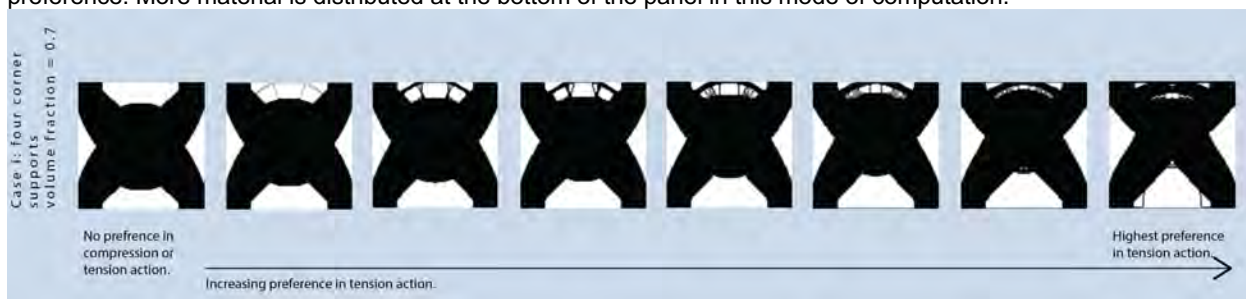

Figure 4. Case i with 0.7 volume fraction can have many shapes based on a change in the preference in the amount of tension action.



Figure 5. Case i with 0.7 volume fraction can have many shapes based on a change in the preference in the amount of compression action.

1.3. Assessing the Performance of the Topologically Optimized Forms

The topologically optimized forms are aesthetically inspiring; however, their enhanced performance needs to be verified. For comparing different geometries, the environmental impact of material use, namely CO₂ emissions, was used. In the first step (section a), two platforms for estimating CO₂ emissions were benchmarked with Athena software (*Athena Sustainable Materials Institute*, n.d.) and Granta EduPack (*Granta EduPack*, n.d.) in ANSYS. A three-meter wide and three-meter-tall concrete wall with a thickness of 20 cm and various window-to-wall ratios (wwr) was modeled in each platform for benchmarking the result. After analyzing and comparing the results, Granta EduPack in ANSYS was selected for estimating CO₂ emissions for any future investigations. In the next step (section b), a three-meter wide by three-meter-tall façade wall was modeled and covered with a total of nine panels. The experiment evaluated CO₂ emissions of the panels with the same boundary conditions with various volume fractions. Following this rationale, case i (having four corner supports), optimized at 0.7, 0.5, and 0.3 volume fraction was selected for calculating the CO₂ emissions. The goal was to see how reducing materials based on the topologically optimized volume fraction would affect performance.

a. Benchmarking CO₂ emissions in Athena software and Granta EduPack software

In this stage of the study, CO₂ emissions of a concrete wall with different porosities was estimated. Assuming all other building parts remain unchanged, only concrete walls were evaluated for their environmental impact. Also, only 'material use' of the wall was considered. Two software platforms, namely Athena software and Granta EduPack were used for calculating and benchmarking the CO₂ emissions.

Athena Sustainable Materials Institute is a stand-alone software for estimating the impact of buildings. It estimates different life cycle assessment (LCA) measures such as global warming potential, acidification potential, and ozone depletion potential in different life cycle stages of buildings (Khodadadi, 2019). Athena Software offers various building assemblies and requires the user to define them in their platform. A three-meter wide and three-meter-tall concrete wall (9.84 feet by 9.84 feet) was defined in the Athena software. The thickness of the concrete wall was set to the default value, which is 20 cm (8 inches). Next, the CO₂ emission of the wall with various porosities was calculated. A linear relation between concrete use and CO₂ emissions was expected. Therefore, a series of estimations were done where the window-to-wall ratio (wwr) of this concrete wall changes from 0 (solid wall without any windows) to 0.88 (a wall with an 8 square meter window). CO₂ emissions were reduced from a total of 451 kg in a solid concrete wall to a total of 50 kg in a concrete wall with a 0.88 wwr. It should be noted that this ratio will be different if the thickness of the concrete wall changes. One of the limitations of Athena software is that the thickness of the concrete wall and blocks are predefined, which reduces the flexibility of the platform.

To verify the results obtained from Athena software, a second software platform named Granta EduPack was utilized to calculate the CO₂ emissions of the concrete wall with different wwr. Granta EduPack formerly known as CES EduPack is currently acquired by ANSYS. EduPack comprises of a database of materials and process information, materials selection tools, and a range of supporting resources. It has a module named 'Eco Audit' where designers can calculate the environmental impacts of products made of different parts. Designers can consider the impacts of 'material,' 'manufacture,' 'transport,' 'use,' and 'disposal' of a product. Energy (MJ) and CO₂ footprint (kg) are the indices that are provided by the Eco Audit module. The module needs the mass of a material as an input to be able to provide environmental impact estimates. Density of materials are provided in EduPack material database which is easily accessible through the Eco Audit module to help with manually calculating the mass. A three-meter wide and three-meter-tall concrete wall (9.84 feet by 9.84 feet) was modeled in Rhino. The thickness of the concrete wall was set to 20 cm (8") to create a comparable model to the one previously created in the Athena software. An important difference between the two platforms is that Granta EduPack does not offer 'material assemblies.' Using Granta EduPack software to analyze concrete panels with various wwr, CO₂ emissions were reduced from a total of 480 kg in a solid concrete wall to a total of 56 kg in a concrete wall with a 0.88 wwr. It is important to note that this ratio will change when the wall thickness changes.

Figure 6 illustrates the comparison between the results retrieved from Athena software and Granta EduPack. the overall trend of The CO₂ emissions in concrete walls with different wwr estimated in the two platforms is consistent: there is a reduction in CO₂ emissions on increase of wwr. The estimated CO₂ emissions for concrete was similar in both platforms. On average, Granta EduPack slightly overestimates concrete CO₂ emissions by 8% compared to Athena software. After completing the benchmarking studies, and understanding their potential shortcomings, Granta EduPack was selected to calculate CO₂ emissions of the panels that are topologically optimized. Granta EduPack offers more flexibility in working with complex geometry, it is better suited for comparing different topologies in this study.

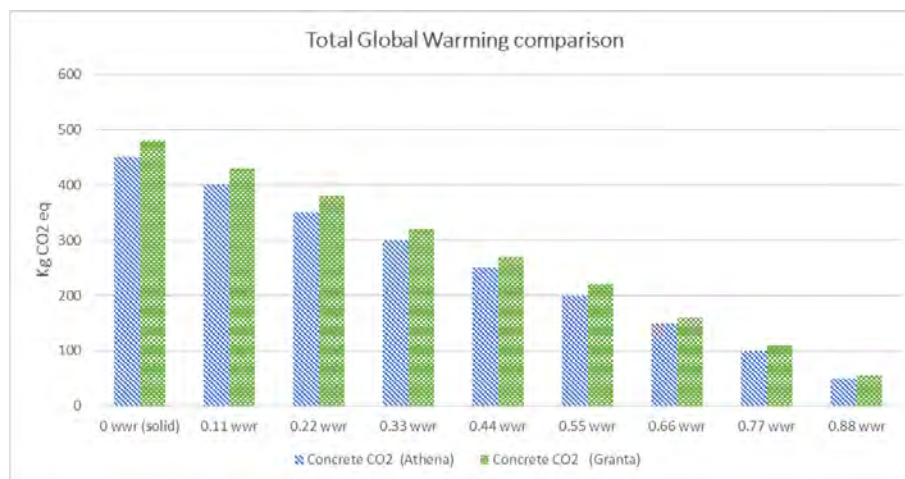

Figure 6. Comparison of results retrieved from Athena and Granta EduPack.

b. CO₂ emission estimations for case i

Three panels that were topologically optimized with 0.7, 0.5, and 0.3 volume fraction with corner supports (case i) were selected for further investigation. Nine 100 x 100 cm panels (39" x 39") with a thickness of 10 cm (4") each were modeled to form a three-meter wide and three-meter tall panel grid. It was assumed that there will be a separate layer of glass behind the panels. The CO₂ emissions of the panel assembly was estimated in Granta EduPack as shown in Figure 7. In addition, Table 2 summarizes the wwr of three topologically optimized panels with different volume fractions computed in Grasshopper. The weight of the panels was also calculated and shown in the Table 2. The density of concrete was retrieved from Granta EduPack database (concrete density = 2200 kg/m²).

Table 2. Estimated CO₂ emission a three-by-three panel grid of topologically optimized panels with various volume fractions with a thickness of 10-cm.

	window-to-wall ratio (wwr)	Weight [kg]	Total CO ₂ emissions of panels (10 cm concrete + glass)
Solid panel	0	1980	240
Case i- 0.7 volume fraction	0.2528	1479	180
Case i- 0.5 volume fraction	0.4251	1138	140
Case i- 0.3 volume fraction	0.5982	795	97

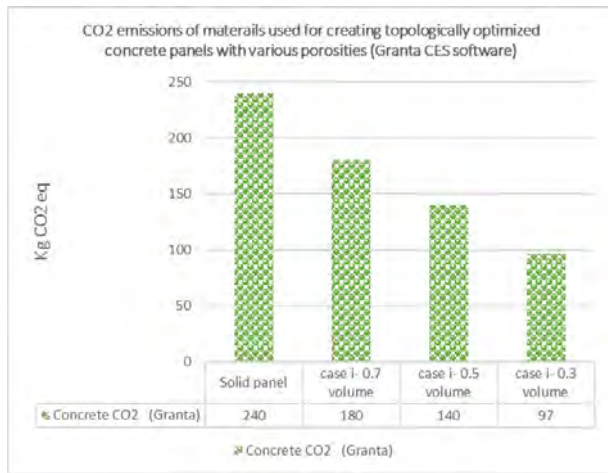

Figure 7. Estimated CO₂ emission of topologically optimized concrete panels using case i.

1.0 RESULTS

Computed topology optimized forms are inspiring for designing precast panels in facades. The boundary conditions of the panels, including the placement of the supports and the direction of applied loads, affect the computed forms. The optimized material distribution in the concrete building elements can impact the buildings at large and reshape the way that buildings look in the city. In addition, the ability to find a form based on material properties by giving a preference to compression or tension allows designers to consider material properties during the computational design process. This design mode will maximize benefiting from the inherent strengths of building materials.

The porosity of the computed topologically optimized panels has implications on the daylighting performance of the spaces. Therefore, calculating wwr is considered. However, according to Table 2, wwr is not necessarily calculated by subtracting the volume fraction from 1. For example, a topologically optimized panel with a volume fraction of 0.7 does not have a wwr of 0.3. Instead, it shows a wwr of 0.25. This discrepancy needs to be validated in future studies by using other topology optimization engines. For this study, the actual perforation ratios of the panels computed in Grasshopper were employed to explain the results.

From a different standpoint, optimizing material placement in concrete panels has environmental implications by saving on material use. Total CO₂ emissions of the three-by-three panel grid decrease from 240 kg when the panel is solid to 180 kg with 0.25 wwr, to 140 kg with 0.42 wwr, and finally to 97 kg in a panel with 0.59 wwr. For every 17% increase in wwr, CO₂ emissions were reduced by about 25%. It should be noted that the thickness of the concrete panels was set to 10 cm (4"), and the CO₂ reduction percentages will vary when the panel thickness changes.

2.0 DISCUSSION

A limitation of this study is using 2D topology optimization, which computes planar forms. These forms were assigned a constant thickness for calculating CO₂ emissions. This limitation is reflected in the linear calculated results between the mass and the CO₂ emissions. Using 3D topology optimization will create forms that are optimized in all three directions. Thus, calculating the environmental impact of panels will add more value to the literature. Therefore, 3D topology optimization where material distribution is optimized in all axes is an important next step. From a different point of view, changing wwr has other implications in the performance of concrete panels, such as daylighting performance. Future studies can consider how various topologically optimized forms will affect daylighting in interior spaces.

CONCLUSION

It is crucial to rethink the way that concrete building elements are designed and used in today's buildings. Porous panels used in facades can largely benefit from topology optimization to make design decisions on the perforation ratio and material distribution of the panels to achieve the highest strength with less material use based on their boundary conditions. The research asks how the connection of the panel to a structural system can affect the porosity of the panel, and proposes 2D topology optimization for generating perforations according to a predefined placement of structural support systems. Doing more with less is achieved by optimizing material use and placement. This line of research will have an impact on integrating building element design, structural system component analysis, and daylighting performance assessment. In addition, this research shows how computational design methods that are mainly used in engineering disciplines can be brought into the architectural design realm to reshape the future of cities.

This research will use 3D topology optimization to arrive at precast panel forms in the future. 3D topology optimization can vary the thickness of the panels and their surface area. Regarding panel fabrication, the fabrication of precast elements relies on creating molds into which concrete or other material is cast. Therefore, in the next phase of this study, design variability will be studied at the level of mold design affecting panel design.

REFERENCES

- Aage, N., Sigmund, O., Amir, O., Maier, D., & Søndergaard, A. (2013). *TopOpt for Grasshopper*. <https://www.topopt.mek.dtu.dk/apps-and-software/interactive-2d-topopt-app>
- Athena Sustainable Materials Institute. (n.d.). [http://www.athenasmi.org/#:~:text=Life cycle assessment \(LCA\) is, and consumption of construction materials](http://www.athenasmi.org/#:~:text=Life cycle assessment (LCA) is, and consumption of construction materials).
- Culver, R., Koerner, J., & Sarafian, J. (2016). Fabric Forms The Robotic Positioning of Fabric Formwork. In D. Reinhardt, R. Saunders, & J. Berry (Eds.), *Robotic Fabrication in Architecture, Art and Design* (pp. 107–121). Springer. <https://doi.org/10.1007/978-3-319-26378-6>
- Dombrowsky, P., & Søndergaard, A. (2009). Three-dimensional topology optimisation in architectural and structural design of concrete structures Evolution and Trends in Design, Analysis and Construction of Shell and Spatial Structures. *Proceedings of the International Association for Shell and Spatial Structures (IASS) Symposium, October*, 1066–1077.
- Etchepare, L., Uranga, E. J., & Zuazua-Guisasola, N. (2015). Marcel Breuer and Jean Baretts in Bayonne (1964-68): The use of architectural precast concrete panels in large public housing schemes. *Construction History*, 30(1), 109–126.
- Gomez, F., Spencer, B. F., & Carrion, J. (2020). Topology optimization of buildings subjected to stochastic base excitation. *Engineering Structures*, 223(August), 111111. <https://doi.org/10.1016/j.engstruct.2020.111111>
- Granta EduPack. (n.d.). <https://www.ansys.com/products/materials/granta-edupack>
- Grindrod, J. (2018). *How to love brutalism*. Pavilion Books.
- Jipa, A., Bernhard, M., Meibodi, M. A., & Dillenburger, B. (2016). 3D-Printed Stay-in-Place Formwork for Topologically Optimized Concrete Slabs. *TxA Emerging Design + Technology*, 97–107. <https://doi.org/10.3929/ETHZ-B-000237082>
- Khodadadi, A. (2019). *Eco-friendly Mid-rise Apartments Using CLT Panels Clean-Tech Design View project Conceptual Design Exploration View project Eco-friendly Mid-rise Apartments Using CLT Panels*. <https://www.researchgate.net/publication/336074007>
- Liverman, A. M. (2008). Hawaiian Modern: The Architecture of Vladimir Ossipoff. *Journal of Society of Architectural Historians*, 67(4), 595–597.
- Lu, X., Xu, J., Zhang, H., & Wei, P. (2017). *Topology optimization of the photovoltaic panel connector in high-rise buildings Topology optimization of the photovoltaic panel connector in high-rise buildings. November 2018*. <https://doi.org/10.12989/sem.2017.62.4.465>
- Paoletti, I., & Natri, M. (2018). Adaptive Façades and Topology Optimization. In M. Overend, L. Aelenei, A. Krstic-Furundzic, M. Perino, F. Goia, F. Wellershoff, S. Attia, U. Pottgiesser, U. Knaack, & C. Louter (Eds.), *Facade 2018 - Adaptive!* TU Delft Open.
- Prynn, J., & Price, C. (2019, February). Save our concrete diamond! Final plea on car park. *The London Evening Standard*, 32.
- Richardson, J. N., Nordenson, G., Laberenne, R., Coelho, R. F., & Adriaenssens, S. (2013). Flexible optimum design of a bracing system for façade design using multiobjective Genetic Algorithms. *Automation in Construction*, 32, 80–87. <https://doi.org/10.1016/j.autcon.2012.12.018>
- Rohan, T. M. (2011). Challenging the Curtain Wall. *Journal of the Society of Architectural Historians*, 66(1), 84–109. <https://www.jstor.org/stable/10.1525/jsah.2007.66.1.84>
- Rozvany, G. I. N. (2009). A critical review of established methods of structural topology optimization. *Structural and Multidisciplinary Optimization*, 37(3), 217–237. <https://doi.org/10.1007/s00158-007-0217-0>
- Shepherd, P., & Pearson, W. (2013). Topology Optimization of Algorithmically Generated Space Frames. *Proceedings of the International Association for Shell and Spatial Structures (IASS) Symposium 2013*, 1–7.
- Stoughton, J. (2015). *A Porous Building Skin for Downtown Los Angeles*.

Evaluation of Spatial Performance in Vertically Integrated Developments Using a Network Science-Based Approach

Srilalitha Gopalakrishnan¹, Chirag Hablani¹, Daniel Wong¹, Benny Chin¹, Anjanaa Devi Srikanth¹, Ajaykumar Manivannan², Roland Bouffanais², Thomas Schroepfer¹

¹Singapore University of Technology and Design, SINGAPORE

²University of Ottawa, Ottawa, CANADA

ABSTRACT: This paper proposes a Network Science-based approach to map the spatial use of public and social spaces on the ground and elevated levels and analyse these spaces as networks of socio-spatial nodes in high-density vertical urban environments to provide insights into actual space use. The presented study integrated micro-mobility sensors data with visual observation surveys and spatial maps to (1) identify mobility patterns of users, (2) establish correlations between mobility patterns, spatial networks, and space-use, and (3) analyse the efficacy of spatial arrangements and their use to allow for better-informed future planning and design decisions. The study used Kampung Admiralty (KA), an award-winning integrated mixed-use building designed by WOHA Architects, as a case study. KA is Singapore's first integrated public development that integrates and co-locates a mix of residential, commercial, retail, community facilities, and social amenities, including green open spaces in a vertically distributed spatial arrangement. The study provides important insights into the relationship between the socio-spatial networks at the ground and elevated levels and identifies key connectors that encourage, influence, and enable socially and spatially effective vertical public space networks. It further presents a framework for quantitative analysis that can inform the efficient and effective planning and design of vertically distributed spaces that can support higher population densities, higher environmental sustainability standards, and enhanced liveability.

KEYWORDS: Spatial performance, Spatial Network Analysis, Network Science, Mobility Patterns

INTRODUCTION

With cities in many locations becoming denser and built environments scaling new heights, the effective and efficient planning and design of sustainable high-density urban environments are critical to their successful integration into larger urban and natural contexts. In such environments, integrated mixed-use buildings are increasingly becoming vertical extensions of urban spaces on the ground level, where circulation, open spaces, ecological networks, and human activities are stacked vertically in an evolving relationship (Schröpfer 2020). As a result, socio-spatial networks extend and stretch vertically, and their planning and design need to reflect the complex interactions within themselves and with the larger urban network.

In recent times, researchers from many fields, including natural and social sciences, are collectively studying cities as 'Urban Complexity' (Batty 2012; Barthélemy 2003; Bettencourt 2013). The studies provide important insights on an informed approach to planning, designing, and managing urban built environments. Urban complexity focuses on the interactivity between the space users and their built environments (Alessandretti, Lehmann, and Baronchelli 2018; Manivannan et al. 2018). It leverages digital tools and techniques to develop new knowledge that can inform urban development processes. Increasingly, cities are embracing the predictive potential of a science-based approach to address the complex urban challenges of unpredictability and disruptions and plan future urban spaces that can dynamically respond to the evolving social, spatial and environmental needs of its people. However, while extensive research studies focus on horizontal mobility patterns, little is known about human vertical mobility (Bouffanais and Lim 2019). Complex System Studies thus need to be extended to the vertical dimension to systematically analyse and evaluate the character of spatial and social networks formed as users interact with such vertically integrated built environments.

1.0 RESEARCH CONTEXT AND SIGNIFICANCE

1.1 Network Science and the Built Environment

While the definition of the term 'complex system' is still evolving, definite characteristics of Complexity Theory are exhibited by the interactions within the urban systems of cities that help us understand their dynamic activity, growth and evolution (Batty 2012). A city manifests itself as a space that enables flows (energy, resources, people, etc.) (Kennedy, Pincetl, and Bunje 2011). Similarly, a vertically integrated building also translates as a network of

interconnected programmatic spaces and circulatory paths, with nodes and links (also called edges), within the superstructure of the urban spatial network (Barthélemy 2003). Each node has defined spatial attributes like the respective typology of space, location, size, etc. These spatial configurations influence human movements, initiate interactions, and generate socio-spatial networks. Studying these socio-spatial networks can provide important insights into the emergent patterns of pedestrian movement within the built environment and its influence on the effective use of social space. This paper presents a new Network Science-based research approach to a systematic analysis of the effects of vertically integrated built environments on human movement using KA as a case study. KA is a first-of-its-kind public development in Singapore, which integrates housing for the elderly with a wide range of social, healthcare, communal, commercial, and retail facility (Yap 2019). Our study focused on the inter-and intra-building networks at the building scale, defining spaces such as hawker centres, sky gardens, plazas, sky bridges, and lift lobbies as nodes.

1.2 Key Network Measures

Measuring network centrality is a mathematical method of quantifying the importance of nodes in a graph. As the name implies, centrality metrics focus primarily on how central each graph element is in relationship to the surrounding elements (Barthélemy 2003; Barrat et al. 2004). In a spatial network, spaces are assessed through network centrality measure algorithms to identify the most significant connectors based on their location and accessibility within the spatial network. In our study of KA, a node is a programmed space with defined boundaries. The edge of the network is an undirected link formed between directly adjacent spaces. Significant network measures include 'degree', 'closeness', and 'betweenness' centrality (Barrat et al. 2004).

Degree centrality measures a node's significance in terms of its connectivity, based on the number of its links. The higher the degree number, the more connected the node is within a network. This measure helps find the spaces with the most connections within a spatial or social network. Determining the degree centrality score allows for the effective planning of active social spaces that act as critical connectors. **Closeness centrality** scores each node based on its closeness to other nodes in a network. The closeness measure uses the shortest paths between each node. Closeness measures help in identifying spatial clusters within building development by highlighting the spatial distribution of high-degree nodes. **Betweenness centrality** characterises a node's global importance by measuring its ability to be part of the shortest paths taken between all nodes in a network. This measure allows for the identification of critical pathways between nodes. A high centrality measure indicates that a node is part of many shortest paths that typically translates into increased human movement and interactions in the built environment—comparing and correlating these various measures allows identifying the significance of spaces in terms of their function and location. It further helps identify parameters for the planning and design of size, co-location, and configurations of social spaces within larger developments.

2.0 METHODOLOGY

The KA study consisted of three key phases to establish the spatial network for analysis, collect real-world data for mapping user-space interactions and overlay real-world data to analyse the dynamic network processes occurring within the static spatial network.

Phase 1: Design Intent and Spatial Network Analysis- KA's architectural design intent and spatial arrangements were studied using the floor plans and architectural drawings. A network structure of nodes and edges was generated based on the built spatial layout and key network measures analysed to understand the designed space's network topology and strengths based on their spatial configurations.

Phase 2: Human Mobility Mapping - Human mobility is the dynamic process on the static spatial network. The study used infrared people counters along with low-energy Bluetooth (BLE) beacons combined with a mobile app for tracking and localisation to record user movements, activities, and space use.

Phase 3: Socio-spatial Network Analysis - Socio-spatial networks are temporal networks where edges form and disappear over time with actual human movements. The socio-spatial network was generated by overlaying the real-world data collected from BLE beacons and people counters on the static spatial network. It mapped user-space relationships, occupancy, and mobility flows as a dynamic process occurring within the embedded spatial structure.

The collected real-world data, analysed and compared with the spatial network measures, provided insight on user-space relationship and information on (1) the use of public and common spaces in the vertically integrated development, (2) user behaviour and movement in space, and (3) social interactions and activities over time.

2.1 Design intent and Spatial Network Analysis

Awarded 'World Building of the Year' in 2018, KA is Singapore's first integrated public development that brings together a mix of public facilities and services under one roof (Block 2018). As the increasing urban density in Singapore demands creative ways of intensifying land use effectively in the vertical dimension, the elevated and layered urban design and architecture approach to the project transformed the 0.9-ha site into a vertically integrated dynamic mini-neighbourhood for the community. As described by WOHA, the development's architect, the design uses a 'sandwich layered approach' that comprises a community plaza located in the lower layer, a medical centre in the middle layer, and a community park with senior apartments in the upper layer of the building (WOHA 2018). The project's community

plaza provides a fully public and pedestrianised ground plane to serve as a community 'living room'. The community park on the roof is a more intimately scaled, elevated green space accessible by residents and visitors. Co-location of complementary programmes such as childcare and an active ageing hub (including senior care) brings together all generations—two 11-storey residential towers consisting of 104 apartments house elderly singles and couples (Block 2018; Yap 2019).

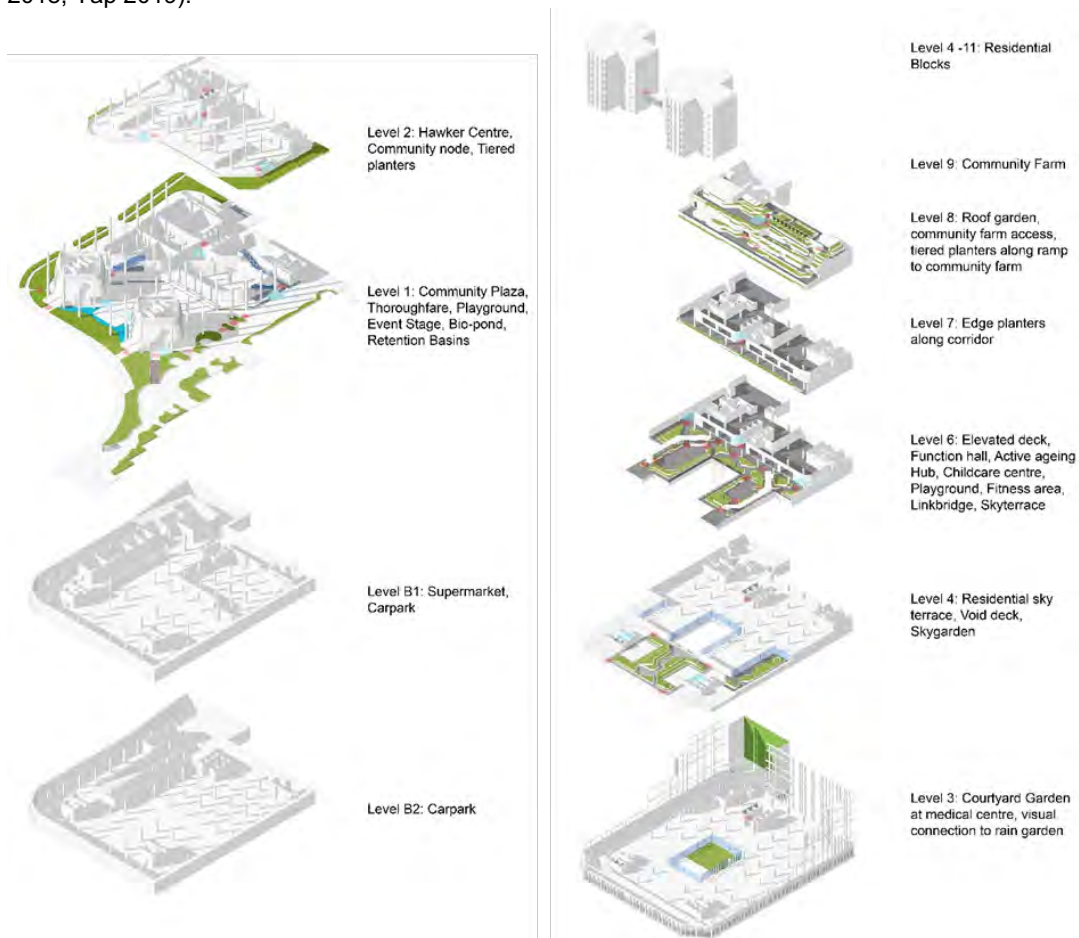

Figure 1: Exploded axonometric of KA showing the vertical distribution of public spaces. (Source: SUTD)

KA's spatial network considered two-node attributes, (1) space type and (2) floor level. Space types included residential, commercial, social, F&B programs, health facilities, and vertical streets (lifts and stairs lobbies). The floor level indicated the location of the nodes and included corridors, staircases, escalators, and ramps connecting the nodes that formed the edges for the analysis. The edges were the shortest routing distances connecting immediately adjacent nodes. In the vertical dimension, the lift and staircase lobbies were considered to have all-to-all connectivity, i.e., each lift lobby was connected to all other lift lobbies if they shared the same lift core. Based on the above classifications, the spatial layout of KA translated into a spatial network with 165 nodes and 392 edges (Figure 2).

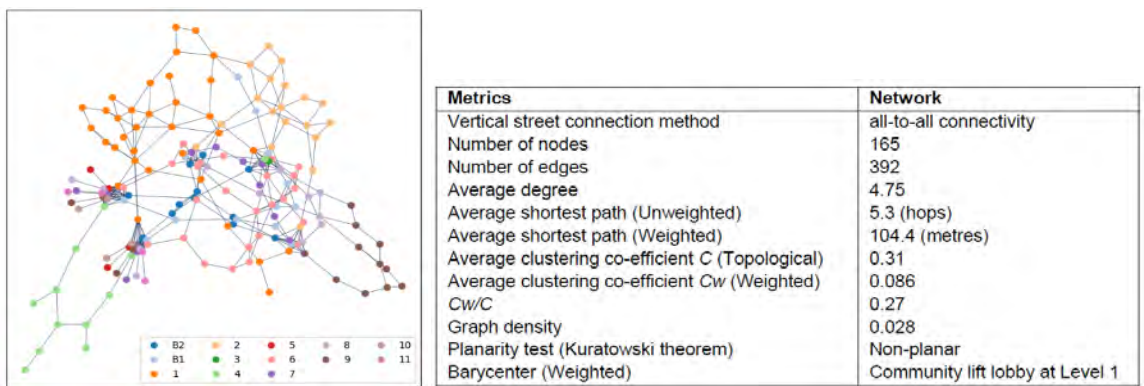

Figure 2: KA spatial network visualised by floor level and tabulation of global properties of the spatial network analysis (Source: SUTD)

The analysis of the spatial network structure of KA based on the spatial arrangements revealed some preliminary insights into the development's connectivity network. For a relatively small network with 165 nodes, the unweighted average shortest path was ~5 for the network, exhibiting the characteristics of a small-world network (Barthélemy 2003). The KA network structure resembled a classical air transportation network due to the presence of vertical streets that give the network a prominent non-planarity. With a compact and integrated spatial arrangement, most of the spaces were easily accessible with an average of 104.4 m travel distance. The community lift lobby was designed to be a central access point for all the community facilities within KA. The network structure confirmed this configuration. The Level 1 Community Lift Lobby was the barycentre of the network, the most convenient point to reach all other spaces within a 50 m travel distance.

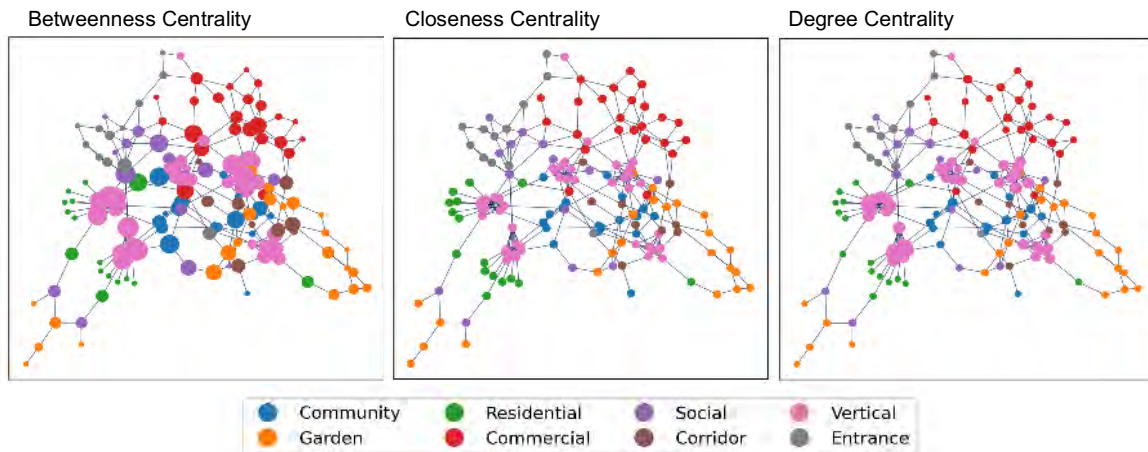

Figure 3: Weighted Centrality Measures of KA Spatial network visualised using Gephi (Source; SUTD)

The community facilities were distributed at multiple levels for heterogeneous pedestrian flows within the development. The more public and highly frequented facilities like supermarkets and retail shops were located at the lower levels. At the same time, the hawker centre at Level 2 provided a key connecting node for all users at KA. Social facilities like childcare, Active Ageing Hub, function rooms, pre-school were located at Level 6, adjacent to the sky garden, creating a more exclusive, intimate public space for the users and residents. The network structure outcomes in Figure 3 were as expected, with the Level 1 commercial spaces emerging as key connectivity nodes, followed by Level 2 and Level 6 spaces forming the second layer of connectivity within the development. The green spaces at Level 1 surrounded the development along the edges, creating a garden-like transition to the community plaza. Social activators at Level 1 like the public performance stage, playground, and water features were subtly placed along the edges to engage the users along their movement routes. In contrast, the sky gardens at the elevated levels were designed as lush green spaces featuring amenities like a playground, fitness corner, seating areas, and social corners to encourage users to spend time. The network structure revealed a hierarchy within the elevated garden spaces. The Level 6 sky gardens formed the most significant green node, followed by the roof garden spaces at Level 8, Level 9 and the Level 4 garden space at the residential blocks.

An unexpected result of the network analysis was the significance of the vertical connections in the overall connectivity of KA, as seen in Figure 3. While the residential lift lobbies were designed primarily to cater to the residents, they also emerged as highly significant vertical connectors to the community facilities, with high values of betweenness, closeness and degree centrality.

2.2 Human Mobility Mapping

The on-site study recruited a sample group of 73 KA users to participate in mapping movement tracking. The participants consisted of residents and non-resident users. Actual use data was collected using a combination of qualitative and quantitative methods. Movement tracking with Bluetooth localisation consisted of three components: (1) stationary low-energy Bluetooth beacons, (2) a mobile app, and (3) a cloud server. The tracking method used a 'peer-to-environment' sensing system that involved placing stationary Bluetooth beacons in locations of interest. 124 beacons were installed on different floors of KA. A custom app installed on participants' smartphones running iOS or Android worked in the background to scan for Bluetooth data from the BLE beacons. The received data contained information about the transmitting beacon such as unique ID, time, telemetry (temperature, etc.), and the transmitting distance (indicating the stationary beacon's reach from the mobile). The data collected from the participants' Bluetooth devices was plotted on the spatial layout to map the participants' movement routines over a continuous period of two to three weeks. In addition, bi-directional people counters using infrared sensors were installed at key nodes identified through spatial network analysis to gather data on the volume of inflow and outflow at the identified spaces during different times of the day and week. The data from the bi-directional counters provided information on the temporal variations in space use volume. BLE beacons and the people counters provided the actual use of the public and common spaces within KA.

2.3 Socio-spatial Network Analysis

The various sensor data collected on-site provided a rich source of over 42.6 million data points for analysis. The collected data from the people counters, Bluetooth beacons and participant surveys were overlaid on the static spatial network to analyse the temporal user-space interactions at KA. The results were then compared to the measures deduced from the initial spatial network analysis. Finally, the comparisons between the designed and actual use of the spaces provided design insights towards developing strategies for planning more effective vertically distributed social spaces. The following section describes the results of the Socio-spatial Network Analysis.

3.0 RESULTS AND ANALYSIS

3.1 Data from People Counters

The data collected from people counters analysed the use of garden spaces and community facilities at KA.

The hourly aggregated number of people at Level 4, Level 8, and the Level 9 garden areas is shown in Figure 4(L). Users predominantly used the Level 4 gardens during the daytime, and the number of visitors was lower than other levels. This correlated with the design intent as these garden spaces were designed primarily for the residential blocks as green niches within the larger development. Distinctly different use patterns at Level 8 and Level 9 gardens indicated the diverse profile of users. In addition to the residents, frequent visitors and volunteers at the rooftop community farm added to the number of users recorded. Interestingly, while the community gardens were frequented during early mornings and late evenings, Level 8 gardens were visited by users even during the afternoon time. Combining well-shaded attractive garden walks with well-defined seating areas effectively encouraged the use of the sky gardens regularly at all times of the day. The hourly aggregated number of people visiting communal facilities is shown in Figure 4 (R). The most traffic was recorded at vertical connections coming to or leaving from Level 2 (hawker centre). The recorded user flows were more significant after 7 am and 5 pm, with a distinct drop in user volumes between 3 pm and 5 pm. It is because the escalators at Level 2 served additionally as connectors to the centre of KA (Level 1 community plaza) and the main transport gateway (the MRT station adjacent to KA), and the peaks reflected the movement patterns of commuters or people who were “moving through”. On the other hand, the gardens on Level 6 and Level 9 served as attractors, and the patterns indicated the movement patterns of leisure users.

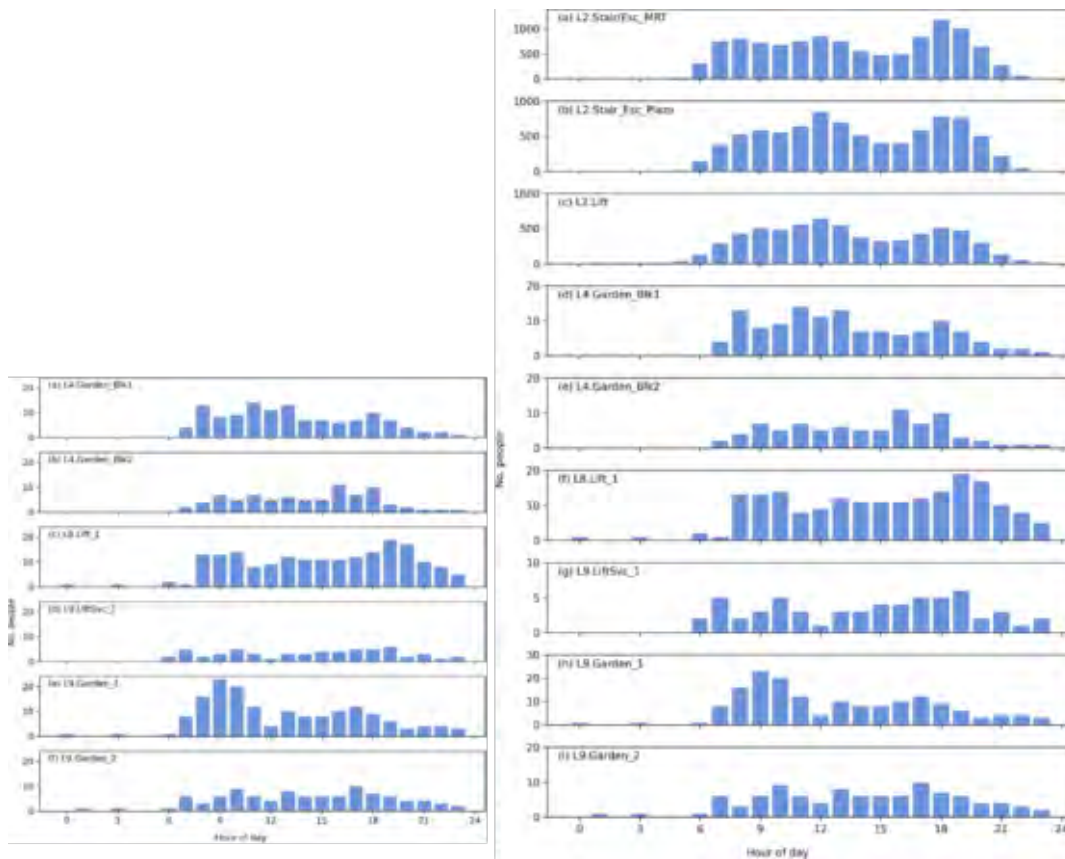

Figure 4: (L) Hourly aggregated use of gardens at different levels (Level 4, Level 8 and Level 9); (R) Hourly aggregated use of community facilities (Source: SUTD)

3.2 Data from Bluetooth Beacons

Bluetooth beacon data was analysed for the network process of mobility and occupancy time of the participant users. The figure below (Figure 5) shows the mobility flows and occupancy times at nodes grouped by floor level and location type. Level 1 registered the highest number of pedestrian flow, followed by Level 6 and Level 2. Among the vertical streets, beacons in Level 1 and Level 6 lobbies recorded the highest numbers in terms of pedestrian flow. At Level 1, mobility was recorded to be similar in magnitude across all the lateral and vertical streets, exhibiting equal flow distribution through different programmes. Another essential characteristic to study urban human mobility was the occupancy time distribution. Occupancy time is defined as the amount of time an individual spends in the defined space. Level 2 saw the highest occupancy time, closely followed by Level 1, Level 4, Level 6 and Level 9. Users in KA spent most time in the commercial streets followed by social spaces and garden corridors. Interestingly, all vertical streets in KA recorded high occupancy time, indicating that vertical mobility was significant and programs were well distributed across all levels within the development. Occupancy time in garden corridors was the longest at Level 9 and users actively spent significant time in the social streets at Level 1, Level 4 and Level 6.

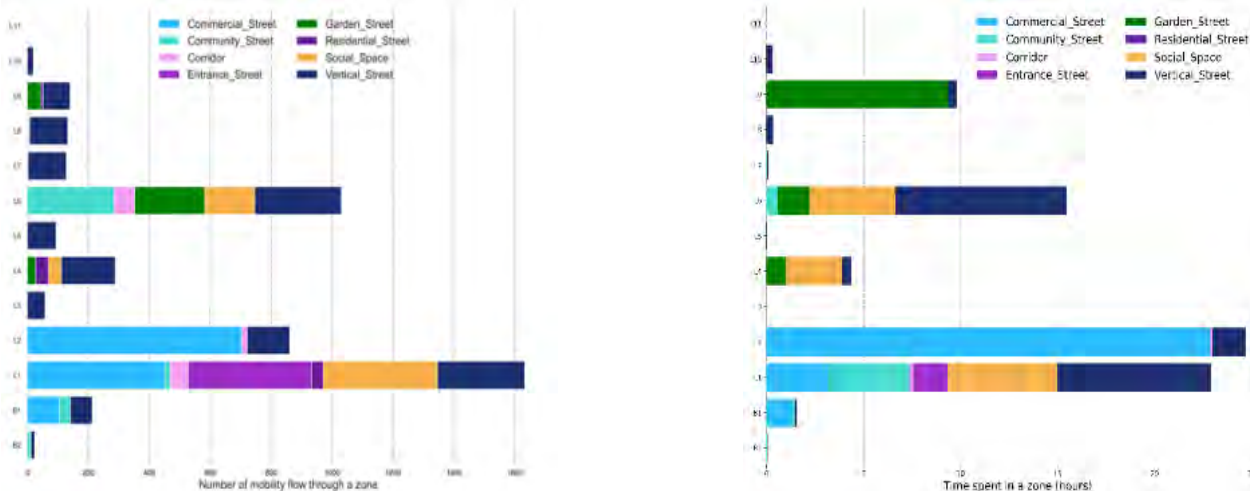

Figure 5: (L) Number of mobility inflow through KA public spaces per floor and location type (R) Time spent at KA public spaces per floor and location type (Source: SUTD)

The correlation between mobility flows and occupancy revealed that many nodes displayed prominence of one function (pathway to move or a place to spend time) more than the other. Figure 6 shows this interplay by floor level and location type. Both Level 1 and Level 2 showed significant mobility traffic and occupancy, with participants being more mobile at Level 1 and spending more time at Level 2. This can be attributed to the food court at Level 2, with ample seating, allowing for higher occupancy. The garden corridors at Level 6 were used primarily as mobility paths, while the Level 9 garden corridors leading to the community gardens saw more prolonged occupation.

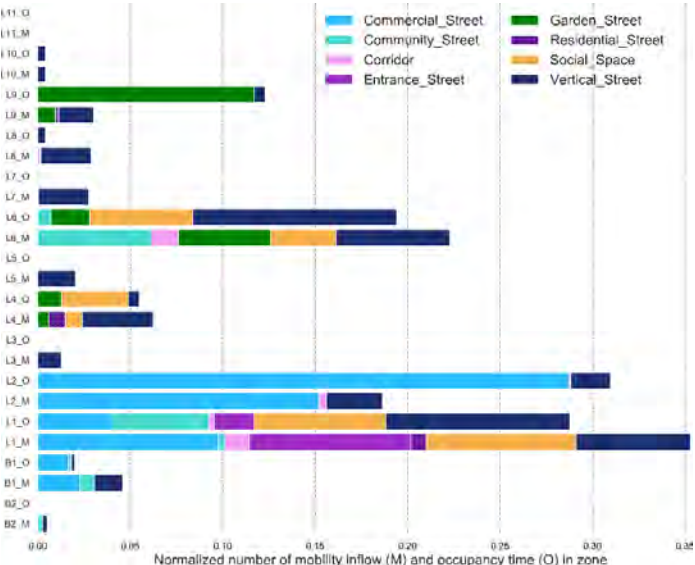

Figure 6: Interplay between mobility and occupancy in KA’s public spaces per floor and location type.

3.3 Visualisation of Participant Flows

The BLE sensor data collected was graphically visualised (Figure 7), allowing for comparisons across nodes. In addition, the activities were visualised as daily aggregates to show socio-temporal networks and how they evolve.

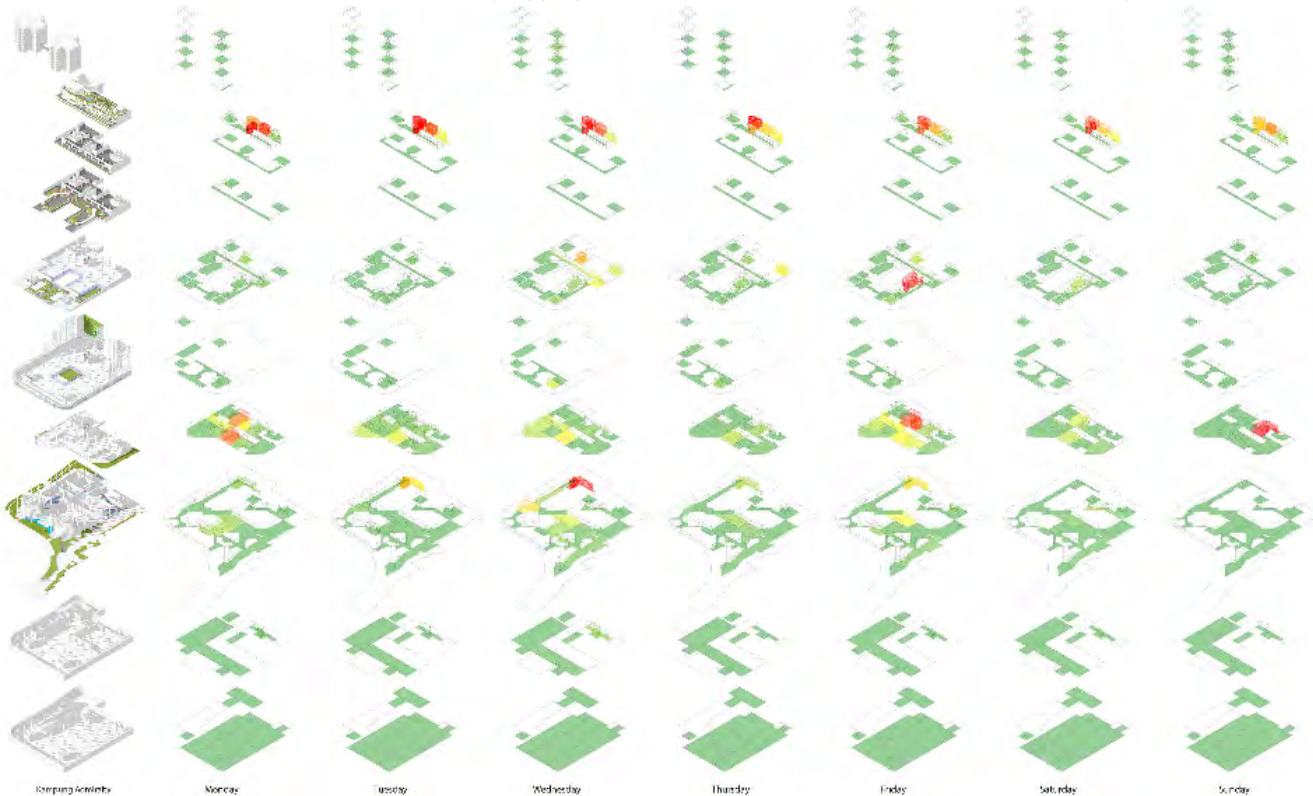

Figure 7: Beacon count at KA mapped on exploded axonometric (Source: SUTD)

4.0 DISCUSSION

The comparison between the actual space use with the centrality measures provides important insight into how socio-spatial temporal networks in KA differed and evolved compared to the theoretical model.

Vertical circulation spaces such as the residential and community lift lobbies served as the most critical paths in KA that connect amenities across levels. While all vertical 'streets' in KA were well connected, some were part of more travel routes than others due to their topological connectivity within the network. The common spaces with adjacency to commercial and retail areas in KA showed high mobility flows. Some commercial streets on L1 and L2 had higher betweenness values, indicating that they act as key connectors within the overall spatial network. KA's L1 community plaza, planned and designed as a central community node, served as a key social space with a high pedestrian flow and activity volume. It showed a high level of connectivity to lift lobbies, amenities within KA and the surrounding neighbourhood. The real-use sensor data collected on-site showed high visitor counts for all the nodes at this location, thus indicating high values of mobility flow. Interestingly, the analysis on the occupancy time in the community plaza showed that people tended to move through it rather than occupy it. The study demonstrated the opportunity for stronger attraction or anchor points in the Community plaza to enhance its potential as a vibrant, well-connected and well-occupied public space. Elevated garden connectors in such vertically integrated developments are effective in distributing and channelling the pedestrian flows. Strategically planning the adjacencies to these garden connectors is critical as access and proximity to KA facilities were key to encouraging elevated garden streets to become a preferred choice of movement and connectivity. The study validated KA's planning and design for placement of such amenities along the most traversed routes. The real-use data further confirmed the mobility flows at this level and its performance as a key central connector. In the vertical integration of public spaces, landscape spaces form key visual and physical connectivity elements with high recreational and social value in KA. These garden amenities form defined destinations with a strong identity or green pathways with activity niches along key connecting routes.

Space types and social programmes can influence circulation flows significantly. Strategically planning the location of attractive amenities in less well-connected areas within a network would help better utilise those parts of development. Doting these 'social attractors' strategically within the network topology would allow for well-distributed effective landscape destinations. The analysis also revealed that most social spaces exhibited prominence as either a movement space or an occupied space. Thus, while all social spaces were expected to be well occupied, nodes set away from

prime connecting routes performed better as social destinations. The mobility flows in KA were influenced by how the different spatial nodes were arranged within the development, their immediate adjacencies, and the travel distance between the different facilities. At the same time, the same network parameters may not drive the time spent by the users at the various spatial nodes. The analytical process showed a valid methodology to derive correlations between the topology, space, and network properties using the collected participant data. It also helped validate the expected versus actual space use of the vertically integrated public and common open spaces.

The KA study was conducted during the COVID-19 pandemic, where social interactions, space use, pedestrian movements, etc., were affected by safe-distancing regulations and requirements. The data would not fully represent how spaces were used before the pandemic when such restrictions on gathering and social interactions were not in place. On the other hand, the study was suitably placed with the status quo being an indicator of the changed urban life as 'new normal'.

CONCLUSION

The presented study explored a Network Science-based approach to the spatial performance analysis of KA and examined its spatial network structure and relationship with network processes such as mobility and occupancy based on real-world data. The results of the study validated our approach to developing (a) a reliable method to convert floor structure and programme to a weighted spatial network, (b) testing hardware and software required to collect user data, (c) developing models to convert sensor data to user-activity info, (d) providing fundamental analyses of the spatial network with tools available in Urban and Network Science, (e) providing a method to visualise network metrics for urban planners and designers, (f) analysing human-tracking data based on user- demographics, and finally (g) designing a method to analyse the relationship between topology, geography, and real-world pedestrian flows in urban built environments. The real-world data collection methods to track users in our study included (a) people counters to understand mobility flows, (b) beacon, mobile app, and cloud infrastructure to track occupancy time and mobility flows, (c) site observation and (d) user surveys. The study demonstrated how these collected data sets could help successfully understand user mobility and occupancy patterns over time. Classifying built spaces as relationships with attributes and applying various network measures to quantitative analytical models can complement current spatial planning and design practices and result in more informed decisions. The methodology explored in our study holds great promise in the validation of actual use of the vertically integrated urban landscape spaces with its predicted and intended use. However, to explore its full potential as a predictive design tool, the methodology needs to be tested more aggressively on different integrated building typologies at multiple scales to establish quantitative and qualitative planning and design parameters for wider application. Applying these research methods and tools to multiple case study sites at a building and urban district scale will potentially provide the necessary data to develop a predictive planning and design tool for vertically integrated urban developments and provide us with a better understanding of the complex correlations between humans and the built environment across multiple city scales.

ACKNOWLEDGMENTS

The research project presented in this paper was part of the Singapore Government's *Urban and Network Science for Urban Solutions Research Program*. It was a 'deep collaboration' with the Ministry of National Development Centre for Liveable Cities, the Urban Redevelopment Authority, and the Housing & Development Board Singapore. The project was supported by a Singapore Ministry of National Development research pilot grant.

REFERENCES

- Alessandretti, L., S. Lehmann, and A. Baronchelli. 2018. Understanding the Interplay between Social and Spatial Behaviour. *EPJ Data Science* 7 (36). <https://doi.org/10.1140/epjds/s13688-018-0164-6>.
- Barrat, A., M. Barthélemy, R. Pastor-Satorras, and A. Vespignani. 2004. The Architecture of Complex Weighted Networks. *Proceedings of the National Academy of Sciences of the United States of America* 101 (11): 3742–52. <https://doi.org/10.1073/pnas.0400087101>.
- Barthélemy, M. 2003. Crossover from Scale-Free to Spatial Networks. *EPL* 63 (6): 915. <https://doi.org/10.1209/epl/i2003-00600-6>.
- Batty, M. 2012. Building a Science of Cities. <https://doi.org/10.1016/j.cities.2011.11.008>.
- Bettencourt, L.M.A. 2013. The Origins of Scaling in Cities. *Science* 340 (6139): 1438–41. <https://doi.org/10.1126/science.1235823>.
- Block, I. 2018. WOHA Creates Green Community with Kampung Admiralty in Singapore. <https://www.dezeen.com/2018/12/07/kampung-admiralty-woha-singapore-world-building-year/>.
- Bouffanais, R., and S.S. Lim. 2019. *The Rise of Homo Verticalis*. In Scientific American Blog Network.
- Kennedy, C., S. Pincetl, and P. Bunje. 2011. The Study of Urban Metabolism and Its Applications to Urban Planning and Design. *Environmental Pollution* 159 (8–9). <https://doi.org/10.1016/j.envpol.2010.10.022>.
- Manivannan, A., WQ. Yow, R. Bouffanais, and A. Barrat. 2018. Are the Different Layers of a Social Network Conveying the Same Information? *EPJ Data Science* 7 (34). <https://doi.org/10.1140/epjds/s13688-018-0161-9>.
- Schröpfer, T. 2020. *Dense + Green Cities: Architecture As Urban Ecosystem*. Birkhäuser.
- WOHA 2018. Kampung Admiralty / WOHA |. *ArchDaily [Online Magazine]*. *ArchDaily*, October. <https://www.archdaily.com/904646/kampung-admiralty-woha>.
- Yap, C.B. 2019. Kampung Admiralty: Building for All Ages. *Ethos*, April. <https://www.csc.gov.sg/articles/kampung-admiralty-building-for-all-ages>.

Visual Data-Based Spatial Analysis of Built Environments

Daniel KH Wong¹, Chirag Hablani¹, Thomas Schroepfer¹

¹Singapore University of Technology and Design, SINGAPORE

ABSTRACT: The use of data-driven spatial analysis and design tools and methods to support traditional planning and design heuristics has become increasingly important over the last years. Incorporating data derived from the point of view of the user is vital for the successful planning and designing of urban and architectural spaces. These include data that considers the spatial perspective of users in built environments which can be empirically sensed. Precedents include photography, 2D and 3D isovists, Computer Vision-based approaches such as the mapping of urban green, using Google Street View images for public health indicators, social media photos, and architectural design classification. A multi-disciplinary approach could thus be applied to the analysis of the built environment, by systematically quantifying the users' visual experiences while navigating the built environment and then translating these through the use of data-driven tools and methods into relationships and interactions of a spatial network. Our research sets up a framework for the empirical mapping and analysis of the built environment using a combination of Computer Vision, 360-degree panoramic and point cloud-based techniques. These can quantify key features such as built structures, greenery, water bodies and sky, and their respective extents. Next, the framework embeds those features' values in a network of spatial nodes. We introduce a *Green-Sky-Building* (GSB) diagram that visualises these features, translated in conjunction with network connectivity measures. The contribution of this research is the combination of existing and newly developed technique across inter-disciplinary fields – scene semantic segmentation recognition with spatial network analysis – as a basis to aid spatial design analysis and decision-making. In our conclusion, we discuss how our novel approach to the analysis of the built environment can provide important insights and support the traditional heuristic for the planning and design of urban and architectural spaces.

KEYWORDS: Spatial Design and Analysis, Visual features, Computer Vision, Spatial network graphs

1 INTRODUCTION

The design and planning of urban and architectural spaces affects our daily activities in complex ways. Important small-scale components of the city have a greater influence on their surroundings than is commonly thought, and urban ecosystems deliver important benefits for the quality of the urban environment and for the health and psychological well-being of residents (Schroepfer, 2019). A scientific basis for the design of the interaction of these components of cities is thus crucial. The plethora and nature of information used to support decisions in this process is evolving rapidly in the current information technological renaissance. Since its early days, the goal of better analysis of data, deriving procedures of diagnosis, extracting indications, as well as graphical techniques was of a primary concern (Tukey, 1962). The use of data-informed spatial design and analysis methods to support traditional planning heuristics has become increasingly important over the last few years. The rule-of-thumbs of planners and designers are being augmented with empirical data from multiple sources and sensors, replacing or adding on to existing frameworks and techniques of understanding how built environments affect interactions of people, societies, and cities at the fine to larger scale.

Urban analytics now incorporates the structural as well as temporal science of cities, dealing with issues of complexity, scaling, allometry, as well as daily variations in transportation, social networks (Batty, 2019). It has become a mainstream approach in understanding the structure and circulation analysis of a spatial network (Boeing et al., 2021), using existing tools in graph-based spatial analysis, in conjunction with new and evolving computationally aided techniques from different disciplines. A ground-up approach from the spatial user point of view can be invaluable when understanding how individual users interact with their surroundings in a larger complex dynamic system that comprises other people, the built environment, and nature at scale. The research on *Imageability* studied the physical elements of the environment, including paths, edges, districts, nodes, and landmarks, which help people understand, navigate, and orientate themselves in it (Lynch, 1960). By incorporating multiple types of data derived from the diversity of the experience of cities, including that of the user, a more inclusive and successful planning and designing of urban and architectural spaces is facilitated. A multi-disciplinary approach could thus be applied to the design and analysis of the built environment, by systematically quantifying the users' visual experiences at street level, then embedding these analyses into the relationships and interactions of its spatial network.

Precedents have evolved from laborious traditional photography and survey-based research in the case of Lynch; to 2D and embodied 3D isovist simulations (Krukar et al., 2021); to recent Google-Street View (GSV) based approaches.

The use of street-view images in documenting urban scenes and architectural frontage has contributed to unique studies that harnessed existing visual datasets more often than generating new images for analysis. They used a combination of Computer Vision (CV)-based, spatial mapping, crowd-sourcing and/or geo-embedded information for various purposes: the urban mapping of green (Seiferling et al. 2017); Green index and Canyon Sky View (CSV) defined by building edges, and meta-data information of the GSV images used in their geolocation and analyses (Li et al, 2016); correlation of GSV building features with geolocated area public health indicators (Nguyen et al. 2019); architectural design classification (Yoshimura et al. 2018); safety, beauty, and historicity of places through crowd-sourced opinions on city streetscape photos which are then used to classify and rate more city images in MIT's Senseable Lab project *Placepulse* (2016); City Bikeability (Ito et al., 2021); social media imagery and text (Liu et al. 2020); In *FaceLift: A Transparent Deep Learning Framework to Beautify Urban Scenes* (Joglekar et al., 2020), a deep learning framework used GSV images and was trained to identify beautiful urban scenes, and subsequently alter and beautify existing views with specific urban elements. These views were then presented to 20 architectural experts who agreed that the results benefited three areas: *decision-making, participatory urbanism, and the promotion of restorative spaces*. In their paper (Liu et al., 2017), wide coverage GSV images were analysed through machine learning models, resulting in a "medium-to-good estimation of people's real experience", with the results applying to different stakeholders such as researchers, planners, and residents. These studies translated empirically sensed data in built environments including the spatial perspective of users into frameworks which can be further quantitatively analysed with some even directly generating resultant visualizations that further gave insight to stakeholders such as planners, designers, policymakers, and residents.

To this end, we study the use of visual data to answer the research questions: How can we use visual data to scientifically aid the design of circulation flow and spatial elements at the urban-architectural scale? How can we harness nascent technology in the field of architecture and urban analytics using visual data for potential real-time analysis of the built environment?

2.0 METHODS AND MATERIALS

2.1. Mapping Visual Data to Spatial Networks

Our research adds on to the framework of spatial network analysis at urban-architectural scale by the empirical mapping of the built environment and relating that to its spatial network for analysis, using a combination of methods. First, a computer vision analysis of 360-degree imaging panorama and point cloud-based techniques, which quantify key features such as urban built structures, greenery, water bodies and sky, and their respective extents. Next, the framework embeds the values of those features into a network of spatial nodes and analyses these nodes in conjunction with their network measures. These features, translated in conjunction with spatial network connectivity measures, are then visualized to identify emergent patterns of related spatial clusters and potential correlation with areas of higher connectivity and hence, potential space use. By quantifying and embedding key features as edge weights in a spatial network graph, we can map and differentiate regions with spatial and visual features that can potentially be used for the analyses of spatial experience and performance. Conversely, when used during the design process to intentionally include features of interest, this process can inform future planning and design strategy.

Our study was carried out in three phases. The first onsite phase included image capturing on the Singapore University of Technology and Design (SUTD) Campus. We mapped out the spatial network of the Campus. The image captures were analysed using a Deep Convolutional Neural Network (DCNN)-based computer vision algorithm with a model implementation pre-trained on the Cityscapes dataset. The results were visualized with Rhinoceros Grasshopper in conjunction with network centrality measures.

2.2. Visual Data Capture: 360-degree Panoramic Imaging

In this context, the 360-degree image capture of a space provided a snapshot in time and immersive experience of the built environment at a single point, simulating the visual experience of a person at the position from a 360-degree point of view. The commercial availability and end-user browser integration of this technology and platform allows quick documentation, representation, analysis, and information representation, for further integration with other platforms such as Virtual, Augmented and Mixed Reality.

Our study captured 360-degree panorama images from the node points of the SUTD Campus using a portable, commercially available camera, the Insta360 One X2. It was placed on a floor stand at about 1.5m height, approximating a person's visual perspective. This 360-degree camera uses dual fisheye lens with 5.7K resolution, H.265 video encoding, image stabilization, and purpose-built algorithms in the commercial app to stitch image captures into both spherical and equirectangular panoramic formats. The spherical output images are user-rotatable in the app simulating an immersive visual environment. We used the equirectangular images in our subsequent analysis (e.g., Figure 1)

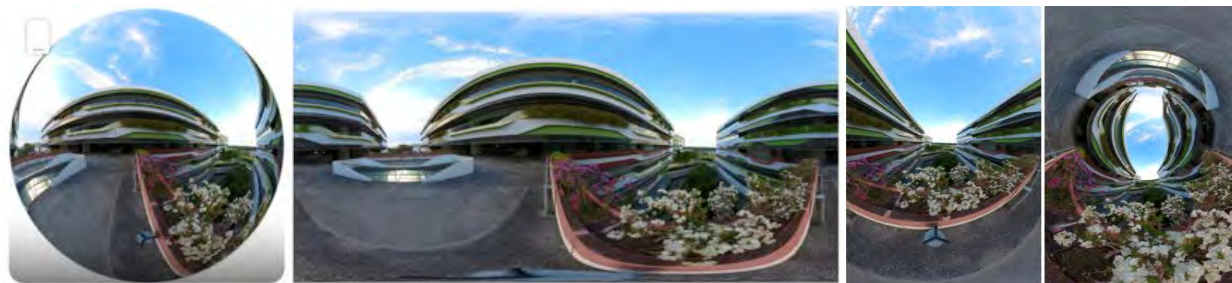

Figure 1: 1. Output Images of 360-camera captures. Spherical (first image), equirectangular panorama (second image), and 2 perspectives captured within the scrollable immersive app environment (third and fourth images).

2.3. Computer Vision Segmentation of Images

A subset of machine learning, the field of Computer Vision (CV) studies the automated extraction, analysis and understanding of useful information from images, achieving automatic visual understanding through development of theoretical and algorithmic basis (BMVA, 2017). In LeNet-5, the classic letter recognition Convolutional Neural Network (CNN), input images are subsampled several times into feature map layers, with each 'neuron' unit in a layer receiving inputs from a set of adjacent units in a previous layer (Lecun et al., 1999). Subsequently, a CV pipeline consists of training a CV model on a labelled training image set, validating with a validation set, then testing it on a test dataset to ensure the model shows minimal overfitting on the training set. Recent methods of object detection and recognition use pixel-level labelled semantic segmentation, for the separation of semantically related 'blobs or objects, making possible applications such as augmented reality wayfinding in GSV, virtual backgrounds and mixed reality in online conferences, and even street-embedded game applications. In general, CV semantic segmentation models today use a unique Deep Convolutional Neural Networks (DCNN) CV architecture tailored for it. Segnet, a widely referenced model uses

an encoder network, a corresponding decoder network followed by a pixel-wise classification layer. The architecture of the encoder network is topologically identical to the 13 convolutional layers in the VGG16 network. The role of the decoder network is to map the low-resolution encoder feature maps to full input resolution feature maps for pixel-wise classification. The novelty of SegNet lies in the manner in which the decoder upsamples its lower resolution input feature map(s). Specifically, the decoder uses pooling indices computed in the max-pooling step of the corresponding encoder to perform non-linear upsampling. This eliminates the need for learning to upsample. The upsampled maps are sparse and are then convolved with trainable filters to produce dense feature maps. (Badrinarayan et al., 2017)

As the objective of this study was discerning the extent of relevant object classes, we chose an available existing CV model already pre-trained in city datasets, the Enet Deep Neural Network semantic segmentation model. Based on Segnet, it has the advantage of speed as it was developed for application to mobile video analysis of vehicular scenes in mind. This gives it the future potential of applying to real-time urban analytics. Enet was scripted with Torch7 machine-learning library and uses several CV design principles to speed up the CV process. Enet follows the Segnet approach by downsampling thus reducing memory usage, with filters operating on downsampled images gathering more field context. Early downsampling reduces the input size while using only a small set of feature maps. These and other characteristics (Paszke et al. 2016), contributes to its speed and relative accuracy.

While we used the model that was pre-trained on the Cityscapes dataset (Cordts et al., 2016), the Enet CV model could be trained for specific datasets depending on the required application such as a variety of indoor or outdoor spatial contexts. The Cityscapes dataset consists of 20 classification type labels as follows: *unlabelled, road, sidewalk, building, wall, fence, pole, traffic light, traffic sign, vegetation, terrain, sky, person, rider, car, truck, bus, train, motorcycle, bicycle*.

As the image captures for this study were 360-degree equirectangular panoramas, consideration was given to research addressing specifically this format. We found that some studies used converted 360-degree panoramas such as perspectives (Lai et al., 2018), stereographical projections (Yang et al., 2018), or cube maps from which a saliency map is derived (Monroy et al., 2018), while others used scenes in spherical or equirectangular settings with rotational alignment (Davidson et al., 2020) or omnidirectional approaches (Sekkat et al., 2020). The recognition of indoor objects was also a consideration as the CV model chosen for this study was based on outdoor cityscapes. Hence, we noted for future exploration to pre-train CV model on indoor images, such as the SUN-RGB or 360-Indoor datasets (Chou. et al., 2020).

2.4. Visual Data Capture: Point Cloud Imagery

A 3-dimensional (3D) point cloud is a set of data points in a 3D coordinate system. These data points are usually defined by X, Y, and Z coordinates, and colour values for external surfaces of an object based on laser scanning or photogrammetry. Over the last decade, reality capture techniques such as laser imaging that can generate 3D point

cloud data have enabled increasingly accurate and economical point cloud data acquisition. Major applications of point cloud imaging today are 3D model reconstruction and quality inspection of construction works, as well as dimensional quality, surface quality, and displacement inspections. In addition to these major applications, 3D point cloud data has also been used for construction progress tracking, building performance analysis, construction safety management, building renovation, construction automation, heritage applications, and robot navigation. Infra-red and LiDAR scanners have been used for these purposes. There is great potential for point cloud captures in future image classification that can be incorporated into spatial analysis and contextual analysis techniques. Our study captured point clouds of several key nodes in the SUTD Campus spatial network using Faro Scene LiDAR for future exploration (e.g., Figure 2).

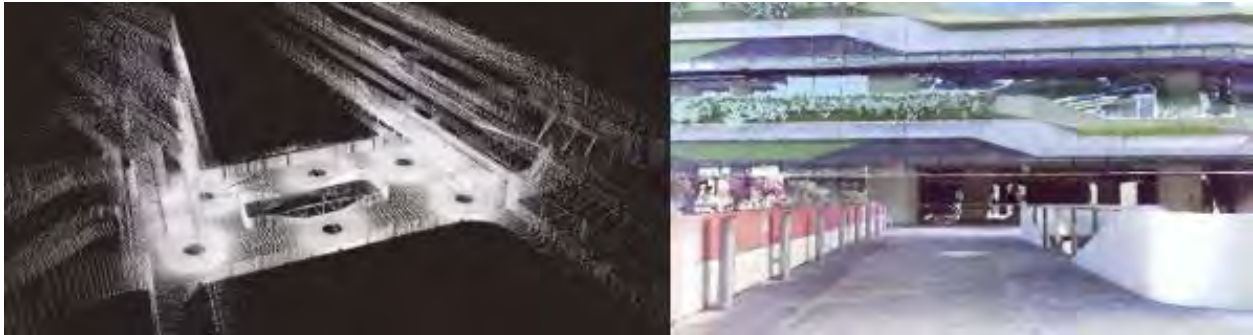

Figure 2: Output Images of LiDAR captures. Point Cloud (left) and combined with colour information (right).

While we applied the Enet CV script to our images, we also did a review of point cloud CV techniques for future exploration. Recent developments in LiDAR-based object inferences are in the field of robotics and autonomous driving and the potential for spatial analysis are due for further exploration. The advantage of using Point Cloud imagery is its accurate dimensional data for the spatial position of objects. In a survey on 3D point cloud deep learning, three broad categories were introduced to correspond to 3D shape classification, 3D object detection and tracking, and 3D point cloud segmentation (Guo et al., 2021). Some examples of CV models for Point Cloud image detection and segmentation follow. PointNet: Deep Learning on Point Sets for 3D Classification and Segmentation, PointPainting (Vora et al., 2019) works by projecting lidar points into the output of an image-only semantic segmentation network and appending the class scores to each point, and the resulting point cloud can then be fed to any lidar-only method. PolarNet, a lightweight neural network, quantizes points into grids using their polar coordinates, learns a fixed-length representation for each grid and uses a 2D neural network for point segmentation results. It achieved 57.2% mIoU performance in the SemanticKITTI dataset and addresses the objectives of “(1) the need for near-real-time latency with limited hardware; (2) uneven or even long-tailed distribution of LiDAR points across space; and (3) an increasing number of extremely fine-grained semantic classes” (Zhang et al., 2020).

2.5. Embedding and Visualizing Data in Spatial Network

Building on the author’s previous research on constructing a graph-based 3D spatial network model from the SUTD campus (Gopalakrishnan et al., 2021), the same spatial network model is used. It characterizes important functional spaces and circulation paths of the Campus as nodes and edges. The network centrality measures were then calculated with the NetworkX algorithm and visualized with the data in a Rhino Grasshopper workflow. We used the following three centralities (degree, closeness, and betweenness centrality) for measuring the connectivity of nodes (Freeman, 1978; Barrat et al., 2004). Degree centrality shows the number of connected links for each node. Closeness centrality measures the distance (in steps) from a node to the rest of the network. Betweenness centrality captures the critical level of a node in terms of being the connection between communities. The three centralities are simple yet useful measurements in complex network analysis for the measurement of important levels of nodes within the network.

3.0 RESULTS AND DISCUSSION

3.1. Image Captures on SUTD Campus

We Captured 73 images of unique locations on various levels in the SUTD Campus with the 360-degree camera. Based on visual assessment, the images were categorized as indoor (34), semi-outdoor (15) and outdoor images (24). The CV classification script was applied to these images (e.g., Figure 3), resulting in pixel counts of each of the 20 object classes for the images. The input images were 1024 x 512 pixels with a total of 524288 pixels for each image. All labelled pixels were tallied to ensure there were no unaccounted pixels in the analysis.

We noted various instances where the classified output images had variances with ground truth. As this was primarily an outdoor cityscape dataset, certain elements in the outdoor scenes such as ground, sidewalk, vegetation, terrain, building, and walls appeared to be more accurately classified. For the interior images however, the results were mixed. Next, we recorded the pixel extents of each class in a table.

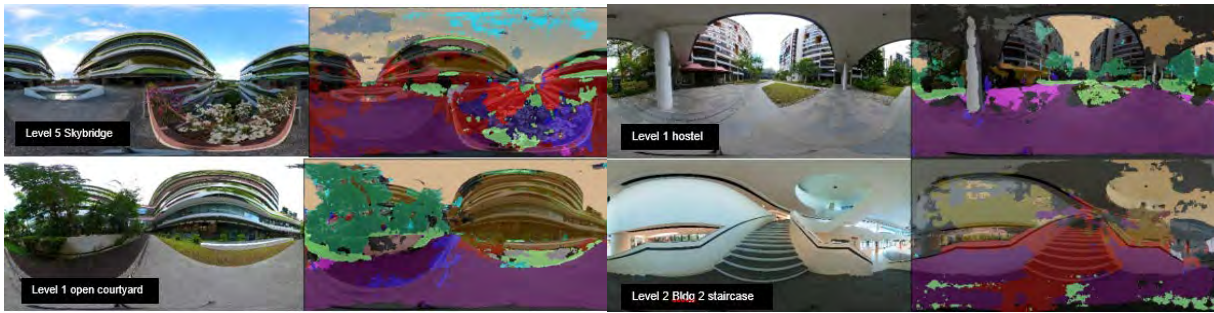

Figure 3: Equirectangular panorama images and detected object classes – outdoor, semi-outdoor and indoor scenes are shown.

We also tested converting some images from equirectangular panorama to cube map formats (e.g., figure 4), and using the same CV segmentation model, noted that the percentage of object class *unlabelled* decreased, thus indicating more accuracy in detecting labelled segments. However, there was variance in the classes, *road*, *vegetation*, *terrain* and *sky* which form most pixels in the images, likely from the mathematical contortion of the image. This would require a more detailed future study in this direction, using models trained on spherical training sets. However, for the purposes of our study, we found the use of equirectangular panoramas sufficient in capturing the proportions of the object class extents.



Figure 4: Comparison of Equirectangular Panorama (left), Cube map (centre), and their variance in Object Class pixels (right).

3.2. Verification of Indoor, Semi-Indoor and Outdoor Scenes

Next, we verified the CV classification of the image set. From the pixel segmentation results, 13 object classes were removed as they were irrelevant to the spatial analysis being carried out in the context of this study, leaving seven classes: *road*, *sidewalk*, *building*, *wall*, *vegetation*, *terrain*, *sky*. These labels correspond broadly to four urban-architectural spatial elements of ground plane (*road + sidewalk*), vertical built surfaces (*building + wall*), greenery (*vegetation + terrain*), and *sky*. For this study, we further removed the ground plane elements that correspond to the *road* and *sidewalk* labels to focus on the other three spatial elements. Figure 5 shows the amounts of greenery, sky, and vertical built surfaces in the indoor, semi-outdoor, and outdoor images. It can be observed that the CV classification corresponds to our expected amount of sky, greenery and built surface views in the three scene types. Thus overall, the CV segmentation classification result is representative of the types of actual views.

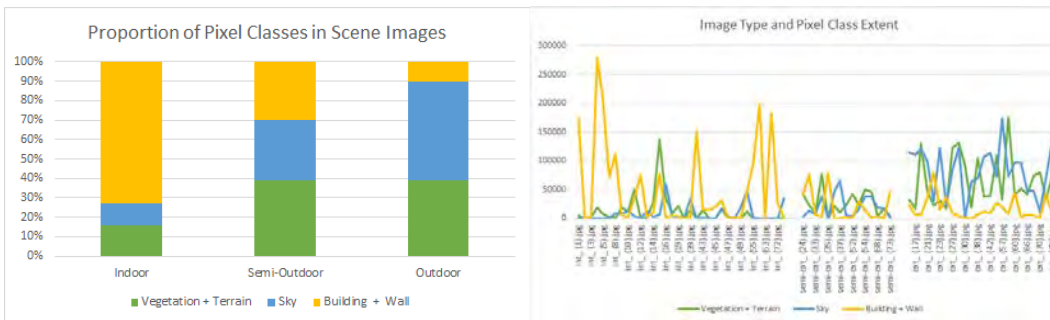

Figure 5: Proportion of 3 types of pixel classes in indoor, semi-outdoor and outdoor scene images (left), and the same comparison, in number of pixels, of individual images (right).

3.3. Urban-Architectural Spatial Elements: Ground, Building, Greenery and Sky

Subsequently we extracted the pixel extents of our defined classes corresponding to *Building*, *Greenery* and *Sky* and applied them to the spatial nodes of SUTD Campus. This spatial network of SUTD was constructed by assigning important functional spaces as nodes and connecting them to adjacent nodes with links, with the lifts and staircase cores serving as vertical all-to-all links in the network. The distribution of the proportion of visible *Building*, *Green*, and

Sky spaces were visualized by overlaying line strokes with the colours red, green, and blue respectively onto the 3D spatial map. The number of coloured line strokes in that space reflects the proportion of object class pixels across the whole collection of images. The visual density of the line strokes in a space is related to both the number of object class pixel numbers and the area of that space. We called this spatial overlay the *Green-Sky-Building* (GSB) diagram (e.g., Figure 6).

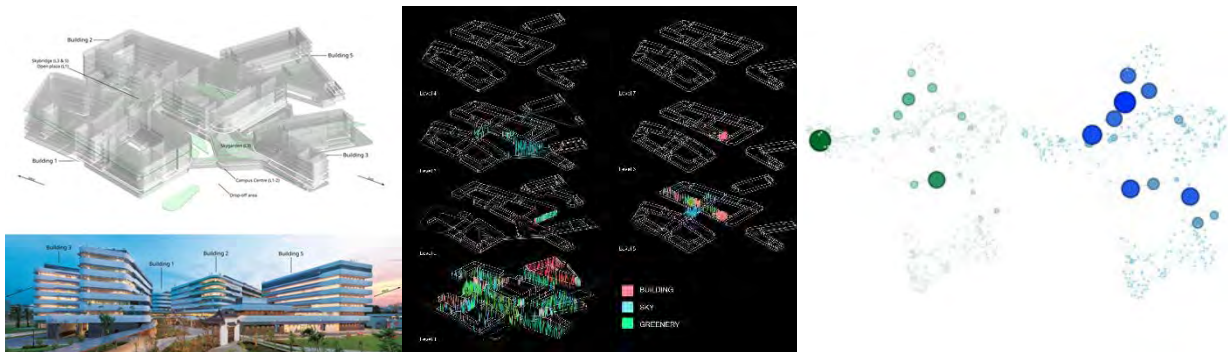

Figure 6: Image and conceptual diagram of SUTD Campus (left; Photograph by Daniel Swee), Image of GSB spatial overlay with selected nodes on all levels (centre), and comparison of graph map of campus nodes overlaid with Green and Sky values (right).

This overlay of GSB information is an indicator of the visual access to the identified categories at a specific location. These data informed our analysis of the experience of the Campus. The analysis is useful for understanding the experience of openness, green and building in each space and in relation to other spaces. When combined with further information such as complexity of pathways, number of fenestrations, materiality of surfaces, signages, presence of seating, and other architectural qualities, an even fuller picture of imageability of spaces can be derived from the visual data. This information can potentially be included using additional visual training datasets with the needed elements. In the context of digital twins, virtual perspective views that incorporate this information are a useful tool that can augment remote sensing of other data in the nodes, such as human activity, and environmental measurements.

3.4. Visualizing Spatial Element Data in Conjunction with Spatial Network Centralities

In this phase, we embedded network centrality information with the visual information as they are indicators of connectivity of the overall spatial system. This provides insights into the potential spatial experience at important nodes and links. The data obtained from the visual analysis can be embedded into the spatial network and visualized as a spatially embedded bar-graph map. In this process, we modified the value line strokes of the GSB diagram with the network centrality measures of the corresponding node to understand the interaction between areas of different connectivity and their visual data. Figure 7 shows the original values of the GSB values, and how they are modified by the relative betweenness and closeness centrality measure of each node, shown by the extended height in red. By quantifying and embedding visual data features in a spatial network graph, we can map and differentiate regions according to their relative importance in the entire spatial network. Conversely, when used as part of the design process, we can analyse a proposed plan for a range of desired spatial and visual features, filtering limits for required design function and spatial experience at key nodes in the urban or architectural plan. This enhances the process of planning and design as well as post-built analyses.

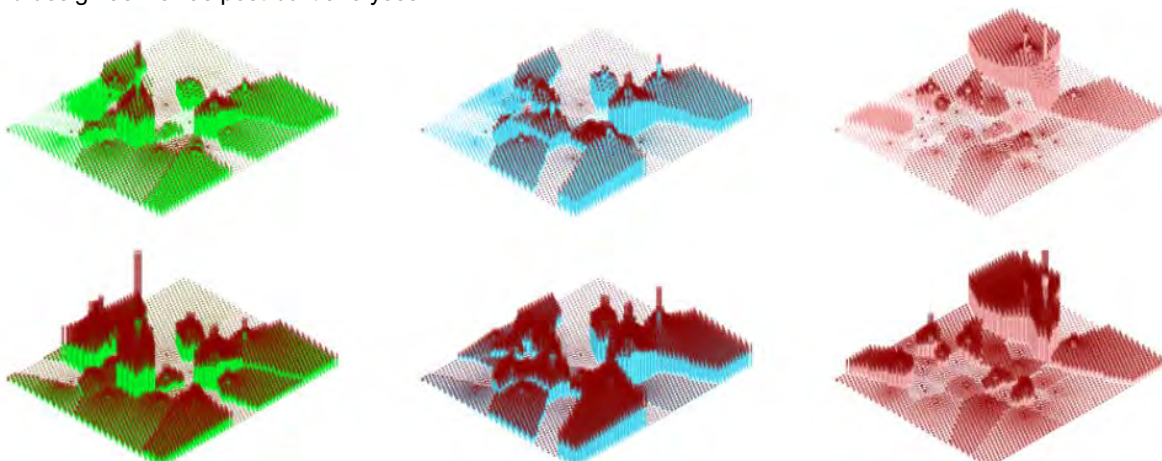

Figure 7: Green(L), Sky(C), Building(R) diagrams of Level 1, modified by Betweenness(top) and Closeness Centralities(bottom)

4.0 CONCLUSION, LIMITATIONS AND FUTURE DIRECTIONS

We studied the use of visual data to answer the following research questions: (1) How can visual data be quantified and used scientifically to inform the planning and design of circulation flow and spatial elements at the urban and architectural scale? (2) How can we harness nascent technology for timely visual analysis of the built environment? We demonstrated that by quantifying and embedding visual data features in conjunction with a spatial network graph, we can map and differentiate regions with spatial and visual features, adding filters for limits in GSB measures. This revealed spaces that correspond to design programme as needed. This can be used for analysing e.g., space use which informs future design urban and architectural design. This framework could be adapted for timely use in various formats, such as table, graphical and visual format, in augmenting design decision-making.

We noted the limitation of available datasets that span the 'in-between' urban and architectural scale containing both outdoor and indoor spatial elements. We observed examples that corresponded in varying degrees with ground truth. Further study could be conducted on models with relevant datasets that have greater mIoU benchmarking accuracy. For the purpose of this study, we used the CV model pre-trained on the Cityscapes dataset as is. In particular, we observed that the Cityscapes feature class *Bus* was represented disproportionately, due to the building facades of the SUTD Campus having a similar visual morphology to linear bands of colour (i.e., roof, glass, sidewall). This relates to facades that bear resemblance to objects that are prevalent in the class features of a particular CV model and visual training set. However, this also engages the intuition of the similarity of design morphology and proportions across differing design categories (i.e., buildings and vehicles) that designers may not identify as grouped similarly – both the façade design of building and buses could very well result in similar floor to ceiling heights and visual banding as they are both based on the human proportion. We acknowledge the limitations of the perspective view - however, our study also aims to consider what is seen from the point of view of a person. Hence, we plan to further explore the use of combined photo and LiDAR based point-cloud segmentation in visual data extraction augmented with depth data for the analysis of visual connectivity of nodes for more comprehensive analysis.

In conclusion, we showed that our framework for a bottom-up approach that uses visual assessment of the built environment can provide important insights and support the traditional heuristic for the planning and design of urban and architectural spaces. The objective of this study was to create a framework for augmenting nodes in a spatial network with quantified visual feature data within a built environment. By being able to analyse features that affect the performance of spaces, we can inform future spatial planning and design. Ultimately, the development of planning and design strategies that include the classification of visual features at an early stage, is the goal of our research.

ACKNOWLEDGEMENTS

This research is supported by a SUTD grant (Cities: PIE-SGP-CTRS-1803).

REFERENCES

- Badrinarayanan, V., Kendall, A., & Cipolla, R. (2017). Segnet: A deep convolutional encoder-decoder architecture for image segmentation. *IEEE Transactions on Pattern Analysis and Machine Intelligence*, 39(12), 2481-2495.
- Barrat, A., Barthelemy, M., Pastor-Satorras, R., & Vespignani, A. (2004). The architecture of complex weighted networks. *Proceedings of the National Academy of Sciences*, 101(11), 3747-3752.
- Batty, M. (2019). Urban analytics defined. *Environment and Planning B: Urban Analytics and City Science*, 43(3), 403-405.
- Boeing, G., Batty, M., Jiang, S., & Schweitzer, L. (2021). Urban Analytics: History, Trajectory, and Critique. *Trajectory, and Critique. SSRN*, 3846508.
- Chou, S. H., Sun, C., Chang, W. Y., Hsu, W. T., Sun, M., & Fu, J. (2020). 360°-indoor: Towards learning real-world objects in 360° indoor equirectangular images. In *Proceedings of the IEEE/CVF Winter Conference on Applications of Computer Vision* (pp. 845-842).
- Cordts, M., Omran, M., Ramos, S., Rehfeld, T., Enzweiler, M., Benenson, R., Franke, U., Roth, S., & Schiele, B. (2016). The cityscapes dataset for semantic urban scene understanding. In *Proceedings of the IEEE Conference on Computer Vision and Pattern Recognition (CVPR)* (pp. 3213-3223).
- Davidson, B., Alvi, M. S., & Henriques, J. F. (2020). 360° Camera Alignment via Segmentation. In *Computer Vision—ECCV 2020: 16th European Conference, Glasgow, UK, August 23–28, 2020, Proceedings, Part XXVIII 16* (pp. 579-595). Springer International Publishing.
- Freeman, L. C. (1978). Centrality in social networks conceptual clarification. *Social Networks*, 1(3), 215-239.
- Gopalakrishnan S., Wong, D., Manivannan, A., Bouffanais, R. and Schroepfer, T. 2021. "User-driven evaluation of emergent patterns of space use in vertically integrated urban environments." *Architectural Research Centers Consortium 2021 International Conference*, April 7-10, 2021, Virtual/Tucson.
- Guo, Y., Wang, H., Hu, Q., Liu, H., Liu, L., & Bennamoun, M. (2020). Deep learning for 3d point clouds: A survey. *IEEE Transactions on Pattern Analysis and Machine Intelligence*, 43(12), 4338-4364.
- Joglekar, S., Quercia, D., Redi, M., Aiello, L. M., Kauer, T., & Sastry, N. (2020). FaceLift: A transparent deep learning framework to beautify urban scenes. *Royal Society Open Science*, 7(1), 190987.
- Ito, K., & Biljecki, F. (2021). Assessing bikeability with street view imagery and computer vision. *Transportation Research Part C: Emerging Technologies*, 132, 103371.

- Krukar, J., Manivannan, C., Bhatt, M., & Schultz, C. (2021). Embodied 3D isovists: A method to model the visual perception of space. *Environment and Planning B: Urban Analytics and City Science*, 48(8), 2307-2325.
- Lai, W. S., Huang, Y., Joshi, N., Buehler, C., Yang, M. H., & Kang, S. B. (2018). Semantic-driven generation of hyperlapse from 360-degree video. *IEEE Transactions on Visualization and Computer Graphics*, 24(9), 2610-2621.
- LeCun, Y., Haffner, P., Bottou, L., & Bengio, Y. (2000). Object recognition with gradient-based learning. In *Shape, Contour and Grouping in Computer Vision* (pp. 319-345). Springer, Berlin, Heidelberg.
- Liu, L., Silva, E. A., Wu, C., & Wang, H. (2017). A machine learning-based method for the large-scale evaluation of the qualities of the urban environment. *Computers, Environment and Urban Systems*, 65, 113-125.
- Liu, Y., Yuan, Y., & Zhang, F. (2020). Mining urban perceptions from social media data. *Journal of Spatial Information Science*, 20, 51-55.
- Lynch K. (1960), *The Image of the City*, The MIT Press: Cambridge, Massachusetts.
- Monroy, R., Lutz, S., Chalasani, T., & Smolic, A. (2018). Salnet360: Saliency maps for omni-directional images with CNN. *Signal Processing: Image Communication*, 69, 26-34.
- Nguyen, Q. C., Khanna, S., Dwivedi, P., Huang, D., Huang, Y., Tasdizen, T., Brunisholz, K. D., Li, F., Gorman, W., Nguyen, T. T., & Jiang, C. (2019). Using Google Street View to examine associations between built environment characteristics and US health outcomes. *Preventive Medicine Reports*, 14, 100859.
- Paszke, A., Chaurasia, A., Kim, S., & Culurciello, E. (2016). Enet: A deep neural network architecture for real-time semantic segmentation. *arXiv preprint*, 1606.02147.
- Schröpfer, T., Menz, S., Jiang, M., Belcher, R., Erdolu, E., Kaushal, M., Pilsudski, T., Raju P., Suen, E., & Tan, J. K. N. (2019). Dense and Green Building Typologies: Architecture as Urban Ecosystem. In *Indicia 02: Future Cities Laboratory* (pp. 32-42). Lars Müller Publishers.
- Seiferling, I., Naik, N., Ratti, C., & Proulx, R. (2017). Green streets – Quantifying and mapping urban trees with street-level imagery and computer vision. *Landscape and Urban Planning*, 165, 93-101.
- Sekkat, A. R., Dupuis, Y., Honeine, P., & Vasseur, P. (2020, June). A comparative study of semantic segmentation using omnidirectional images. In *Congrès Reconnaissance des Formes, Image, Apprentissage et Perception (RFIAP)* (ffhal-03088368f). Vannes, France.
- The British Machine Vision Association and Society for Pattern Recognition (BMVA), 2017-02-16. What is computer vision? *The British Machine Vision Association and Society for Pattern Recognition*.
<https://web.archive.org/web/20170216180225/http://www.bmva.org/visionoverview> (Accessed on November 11, 2021, via Wayback Machine).
- Tukey, J. W. (1962). The future of data analysis. *The Annals of Mathematical Statistics*, 33(1), 1-67.
- Vora, S., Lang, A. H., Helou, B., & Beijbom, O. (2020). Pointpainting: Sequential fusion for 3D object detection. In *Proceedings of the IEEE/CVF Conference on Computer Vision and Pattern Recognition* (pp. 4604-4612).
- Yang, W., Qian, Y., Kämäräinen, J. K., Cricri, F., & Fan, L. (2018, August). Object detection in equirectangular panorama. In *2018 24th International Conference on Pattern Recognition (ICPR)* (pp. 2190-2195). IEEE.
- Yoshimura, Y., Cai, B., Wang, Z., & Ratti, C. (2019, July). Deep learning architect: Classification for architectural design through the eye of artificial intelligence. In *International Conference on Computers in Urban Planning and Urban Management* (pp. 249-265). Springer, Cham.
- Zhang, Y., Zhou, Z., David, P., Yue, X., Xi, Z., Gong, B., & Foroosh, H. (2020). Polarnet: An improved grid representation for online lidar point clouds semantic segmentation. In *Proceedings of the IEEE/CVF Conference on Computer Vision and Pattern Recognition* (pp. 9601-9610).

Thermoelectric Facades: Modeling Procedure and Comparative Analysis of Energy Performance in Various Climate Conditions

Ajla Aksamija¹, Mahsa Farid Mohajer²

¹University of Utah, Salt Lake City, UT

²University of Massachusetts, Amherst, MA

ABSTRACT: This research study presents a methodology for simulating energy performance of thermoelectric (TE) facade systems. These novel facade systems can be used for localized heating and cooling in buildings. Simulations were performed to investigate impacts of TEs on buildings' energy performance by comparing them against a conventional HVAC system. The study was carried out by modeling a typical office space in IDA ICE software program, with an area of 3x3 m² (10x10 ft²) and included one exterior wall (with an incorporated window), three adiabatic interior walls, a floor, and a ceiling. Simulations were performed for 15 different climates (climate zones 1A to 8). To simulate TE system's energy performance, an electric radiator, with characteristics that most closely matched that of the TE system, was used. This included assigning a certain area to the radiator and calculating its rated input power based on the climate condition. Based on the previously conducted research, 15% wall coverage was determined as the optimum area for heating and cooling production. Therefore, area of the electric radiator was assigned as 1.35 m² (15 ft²). Given that the TE system's performance and output depend on the temperature difference between the building's internal and external environments, this was separately calculated for each climate zone and used for modeling energy performance of the TE system. Energy modeling results showed a reduction in energy consumption and improved performance of TE facade systems, compared to conventional HVAC systems. Energy Usage Intensity (EUI) comparison showed that the TE system exhibited improved performance in all climate zones. The results concluded that TE materials are promising intelligent components that can be used in facade assemblies for heating and cooling purposes.

KEYWORDS: Active facades, thermoelectric materials, energy performance, simulation, modeling

INTRODUCTION

Thermoelectric (TE) materials are smart materials that can generate a voltage when exposed to a temperature gradient, utilizing the Seebeck effect and produce a temperature gradient when electricity is applied, exploiting the Peltier effect. They can be used for heating, cooling, and/or power generation, where heating and cooling modes can be switched by reversing current direction. It is possible to use TE modules as an alternative to conventional HVAC systems, when coupled with proper heat exchangers (Snyder et al. 2008). Thermoelectric heating and cooling have several advantages, compared to the conventional systems. The light-weight and compact size of TE modules, lack of mechanical parts, less maintenance requirements and cost, and elimination of chlorofluorocarbons (CFCs) and toxic refrigerants make TE systems environmentally friendly (Boukai et al. 2008; Upadhyaya et al. 2015). Research and development have focused on TE modules that convert heat energy into electricity (Montecucco et al. 2012; Snyder et al. 2008) and TE materials that offer higher energy efficiency through nanoscale engineering (Snyder et al. 2008).

Ibanez-Puy et al. (2015) investigated the design and construction process of a ventilated facade prototype that integrated TE materials. This research investigated the adaptability of heat transfer process within the prototype's air cavity by promoting it when heat dissipation is needed and reducing it when heat losses are not welcome (Ibanez-Puy et al. 2015). Aksamija et al. (2019) studied design and construction of two prototypes with incorporated TEs. One prototype was used to evaluate TE modules as stand-alone elements in the facade assembly, while the other was used to explore integration of TE modules and heatsinks in the assembly (Aksamija et al. 2019). In another study, Aksamija et al. (2020) investigated TE's heating and cooling potential by modeling facade-integrated TE systems and analyzing their thermal performance under varying external conditions. Results were promising and showed the applicability of this novel system for architectural and facade applications (Aksamija et al. 2020).

This study investigated heating and cooling potential and energy performance of TE facade systems, compared to a conventional VAV system. The following sections describe the background, research questions and methodology, and results.

1.0 BACKGROUND AND METHODOLOGY

1.1 Previous Work and Research Objectives

The research study presented in this paper is a part of larger research project, focusing on the integration of TE materials in facade assemblies. The research project started with experimental evaluation of built prototypes, thermal measurements, and simulations of heating and cooling potential. Figure 1 shows one of the prototypes that was used in the experimental study.



Figure 1: Experimental prototype and thermal imaging. Source: (Author 2018)

In the experimental study, prototype's heating and cooling outputs were evaluated using a thermal chamber to represent different external temperatures, while internal temperature was kept constant. Thermal chamber was set to 32°C, 16°C, -1°C, and -18°C (90°F, 60°F, 30°F, and 0°F), representing typical external temperatures found in most climates. The heating mode was tested under 16°C, -1°C, and -18°C (60°F, 30°F, and 0°F) temperatures, while the cooling mode was tested under 32°C and 16°C (90°F and 60°F). A thermal camera was used to measure the temperature of the exterior surface of the prototype. Results indicated that facade-integrated TE materials provide sufficient heating and cooling, as shown in Tables 1 and 2.

Table 1: Experimental results of thermal chamber testing, indicating temperature outputs in heating mode.

Chamber T °C (°F)	Voltage (v)	Current (A)	Power (W)	T output °C (°F)
-18 (0)	0	0	0	20 (68)
	1	0.17	0.17	19 (67)
	2	0.45	0.9	21 (70)
	3	0.74	2.22	23 (73)
	4	1.02	4.08	22 (72)
	5	1.12	5.6	24 (76)
	6	1.42	8.52	27 (80)
-1 (30)	0	0	0	12 (52)
	1	0.16	0.16	14 (56)
	2	0.45	0.9	21 (70)
	3	0.62	1.86	22 (72)
	4	0.87	3.48	21 (69)
	5	1.23	6.15	28 (82)
	6	1.4	8.4	24 (76)
16 (60)	0	0	0	23 (73)
	1	0.08	0.08	23 (74)
	2	0.73	1.46	23 (74)
	3	0.64	1.92	26 (79)
	4	0.9	3.6	27 (81)
	5	1.12	5.6	31 (88)
	6	1.41	8.46	36 (97)

Table 2: Experimental results of thermal chamber testing, indicating temperature outputs in cooling mode.

Chamber T °C (°F)	Voltage (v)	Current (A)	Power (W)	T output °C (°F)
16 (60)	0	0	0	24 (76)
	1	0.36	0.36	22 (72)
	2	0.65	1.3	21 (70)
	3	0.77	2.31	17 (63)
	4	1.08	4.32	8 (46)
	5	1.41	7.05	12 (54)
	6	1.82	10.92	10 (50)
32 (90)	0	0	0	23 (73)
	1	0.19	0.19	17 (63)
	2	0.43	0.86	19 (67)
	3	0.65	1.95	14 (57)
	4	0.92	3.68	19 (67)
	5	1.27	6.35	19 (67)
	6	1.6	9.6	16 (61)

The study was further extended by developing methods for integrating TE materials in various facade assemblies, as shown in Figure 2. For example, aluminium panels would act both as cladding and exterior heat sinks and would be connected to the TE materials with a copper conducting system. An interior heat sink would be installed, acting as a radiant panel to provide heating and cooling. Facade-integrated TE system could be installed as a modular piece and would be insulated from the rest of the exterior wall. The modular nature of this system makes it suitable for all building types and retrofits of the existing buildings.

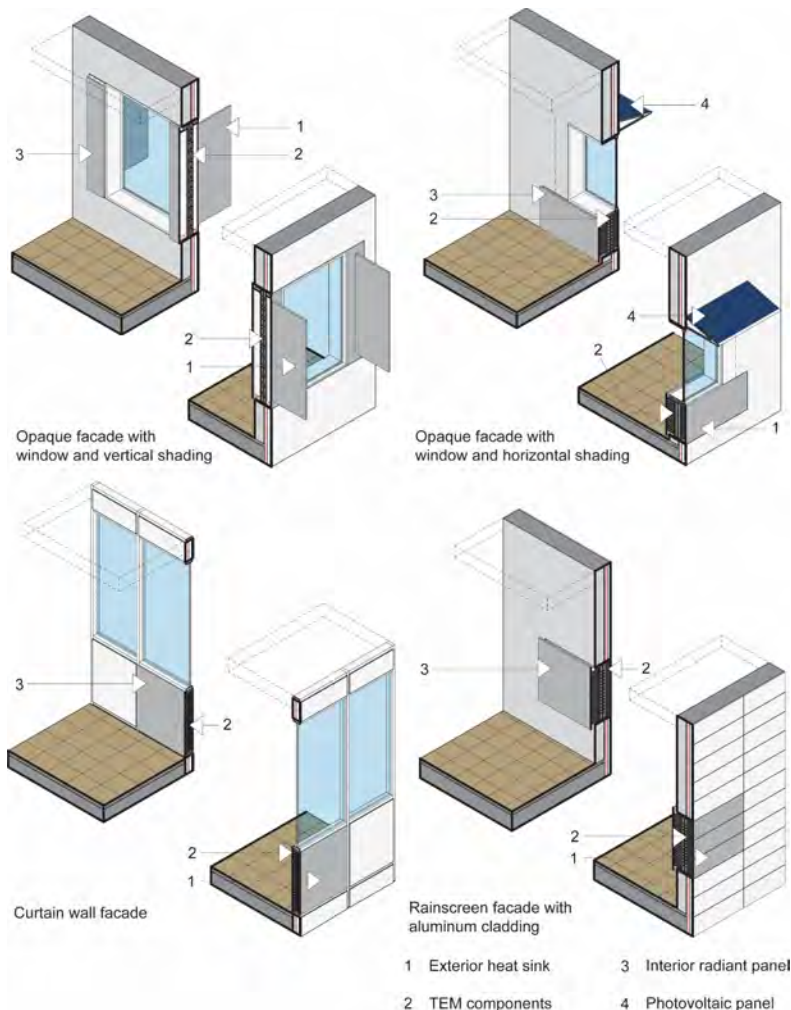

Figure 2: Different types of active facade systems with integrated TE materials. Source: (Author 2020)

In this research study, the objectives were:

- To evaluate energy performance of TE facade systems in various climatic conditions and
- To compare their energy consumption against a conventional HVAC system.

The study was conducted by modeling a typical office in IDA ICE software program, where a single office space was considered. Variables included HVAC system (TE facade as a novel and a VAV as a conventional system), and climate conditions. Fifteen different climate zones were considered, as shown in Table 3.

Table 3: Selected climate zones/regions and representative cities used for the energy modelling.

Climate zone	City	Zone	Region
1A	Miami, FL	Very hot	Moist
2A	Houston, TX	Hot	Moist
2B	Phoenix, AZ	Hot	Dry
3A	Memphis, TN	Warm	Moist
3B	El Paso, TX	Warm	Dry
3C	San Francisco, CA	Warm	Marine
4A	Baltimore, MD	Mixed	Moist
4B	Albuquerque, NM	Mixed	Dry
4C	Salem, OR	Mixed	Marine
5A	Chicago, IL	Cool	Moist
5B	Boise, ID	Cool	Dry
6A	Burlington, VT	Cold	Moist
6B	Helena, MT	Cold	Dry
7	Duluth, MN	Very cold	N/A
8	Fairbanks, AK	Subarctic	N/A

The office space had an area of 3x3 m² (10x10 ft²) and included one exterior wall (with an incorporated window), three adiabatic interior walls, a floor, and a ceiling. The internal loads included one occupant, constant equipment and lighting loads, which were identical in all the developed models.

1.2. Thermoelectric modeling

To model the TE system in IDA ICE software program, 15% wall coverage with TE modules was treated as an electric radiator, covering 1.35 m² (15 ft²) of the building envelope. Due to inability of the existing energy modelling software programs to model and simulate TE systems, the radiant system was used as a representative system. To model the TE system and simulate its impacts on energy performance, characteristics that most closely matched that of the TE system were assigned to the electric radiator, including a certain area (in respect to the building envelope's total area) and a calculated input power. Since TE's performance and output depend on the temperature difference between the building external and internal environments, the input powers were calculated separately based on each climate zone. Here, the indoor temperature was constantly kept at 21°C (70°F) and the maximum and minimum outdoor temperatures were extracted from the historical weather data, specific to each location. In Table 4, power rating calculations for various climate zones are shown. This information was used to develop 30 different energy models, two for each climate zone, where the only differences between the models considered different HVAC type. Results of energy modelling are presented in the following section and implications of these results are discussed.

Table 3: External and internal temperature difference and the associated power rating values for TE system.

Climate zone	Mean delta T °C (°F)	Power rating per TE module (W)	Total power rating (W)
1A	15 (59)	80	2,160
2A	18 (64)	78	2,106
2B	21 (70)	75	2,025
3A	25 (77)	70	1,890
3B	22 (72)	75	2,025
3C	15 (59)	80	2,160
4A	25 (77)	70	1,890
4B	24 (75)	70	1,890
4C	25 (77)	70	1,890
5A	29 (84)	63	1,701
5B	27 (81)	65	1,755
6A	33 (91)	55	1,485
6B	30 (86)	60	1,620
7	32 (90)	57	1,539
8	34 (93)	55	1,485

2.0 RESULTS

Results of the thirty simulations in IDA ICE program included monthly and annual energy performance, as well as Energy Usage Intensity (EUI) for each analyzed climate zone. Monthly energy data included lighting, equipment, HVAC auxiliary, electric cooling, electric heating, and fuel heating. Additionally, given that lighting and equipment types and schedules were identical in all simulation models, energy consumption data associated with them were eliminated from the comparisons. Therefore, in the comparative analysis of the energy performance results, HVAC auxiliary, electric cooling, and fuel heating energy performance were the only data taken into consideration.

Trend of the monthly energy use of TE system vs. that of VAV system was summarized by merging the fifteen climate zones into three categories: very hot to warm (1A to 3C), mixed (4A to 4C), and cool to subarctic (5A to 8). From each category, two zones/locations were selected to represent energy performance differences, as shown in Figures 3 and 4.

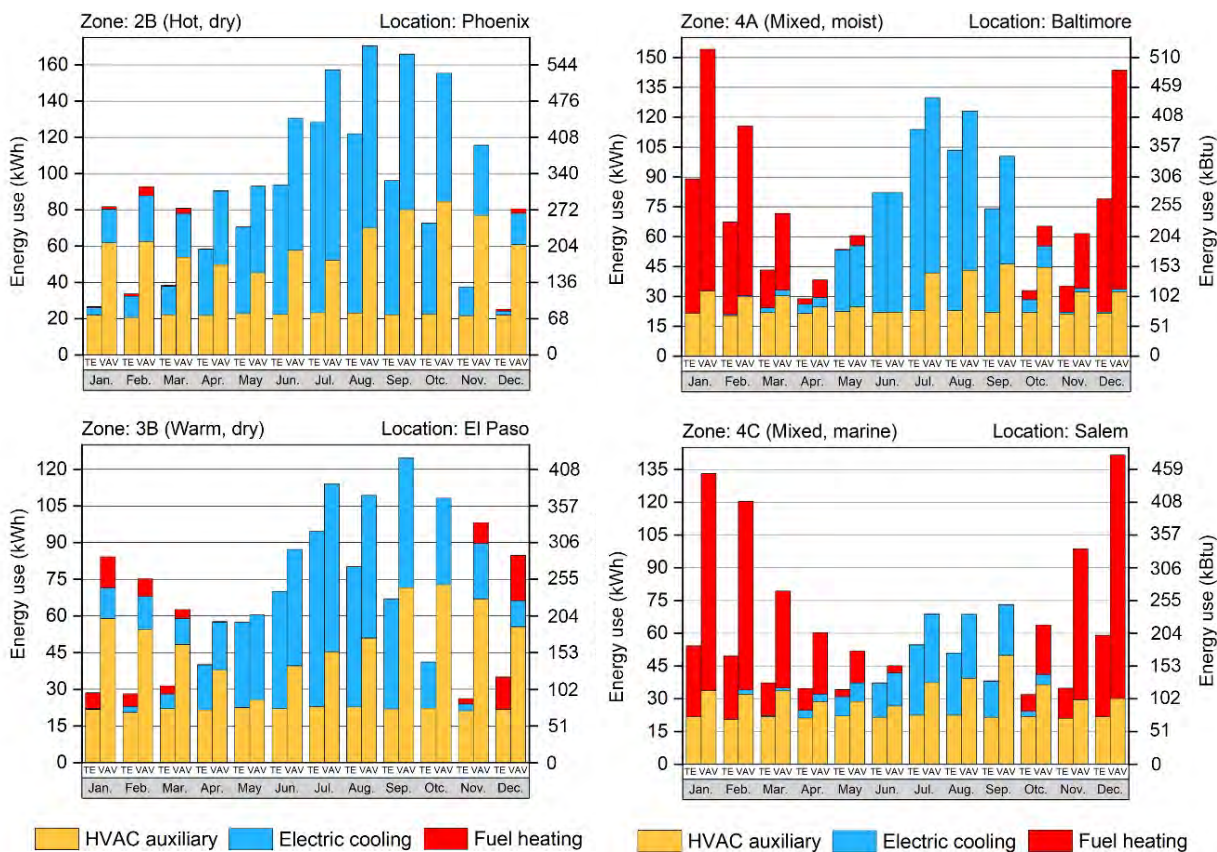

Figure 3: TE vs. VAV monthly energy use in climate zones 2B (Phoenix), 3B (El Paso), 4A (Baltimore) and 4C (Salem). Source: (Author 2021)

Results indicate that monthly energy consumption with the VAV system was always higher than for the TE facade system. Here, considering climate conditions (very hot to warm), higher amount of energy was needed for cooling purposes, compared to heating loads. Heating was only used during the coldest months of the year (January, February, March, November, and December), while electric cooling was predominant during the summer and fall months. Monthly energy usage of the two systems in mixed climates (zones 4A and 4C) was higher than for very hot to warm zones (zones 2B and 3B) due to higher heating loads. TE system showed a significant performance improvement compared to the conventional HVAC system, especially in heating modes.

Figure 4 shows results for monthly energy consumption in climate zones 6A and 8. Here, TE system showed a much higher energy efficiency, specifically during coldest months. In this category (cold to subarctic), there was a significant reduction in monthly electricity use since most of the cooling loads were eliminated except during the hottest months of the year. Moreover, fuel usage for heating purposes was higher than that of the other two climate categories (very hot to warm and mixed), due to the much colder weather conditions.

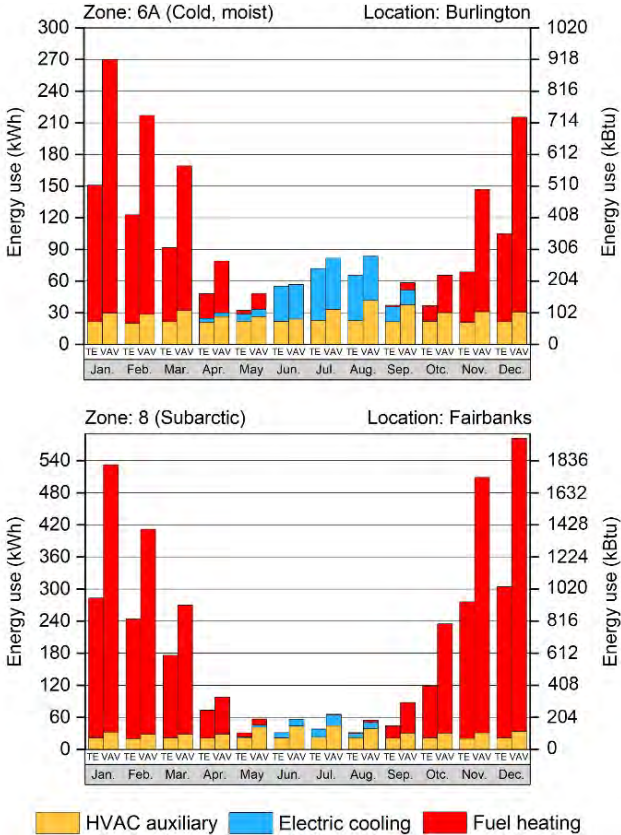

Figure 4: TE vs. VAV monthly energy use in use in climate zones 6A (Burlington) and 8 (Fairbanks). Source: (Author 2021)

Annual energy consumption comparisons of the TE facade vs. VAV systems are illustrated in Figure 5. Here, changes in energy usage (i.e., HVAC auxiliary, electricity, fuel consumption) between the two systems are shown. Considering the variation in weather conditions, moving from climate zone 1A to 8, electricity use for cooling significantly decreased, while consumed fuel for heating purposes remarkably increased. Unsurprisingly, total energy use in climate zone 8 (subarctic), due to the significant increase in heating loads, and consequently, fuel consumption, was significantly higher than other climate zones. In Figure 6, deviations in Energy Usage Intensities (EUIs) between the two systems in the selected climate zones are shown. For this purpose, VAV’s EUI was selected as the baseline, with the objective to compare energy performance of the innovative TE system against that of the conventional HVAC system. Results of the EUI comparison showed that, regardless of climate zones, EUI deviations were always negative, indicating improved energy performance when TE system was used.

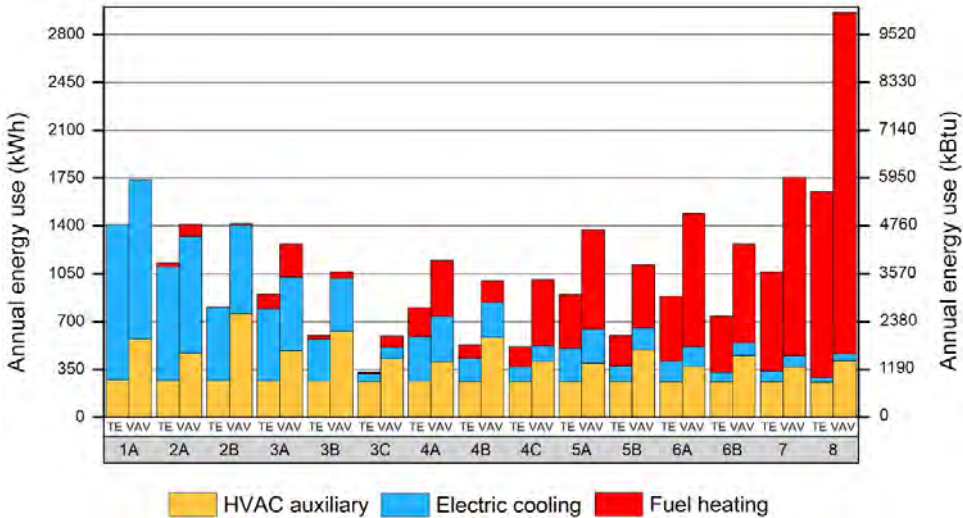

Figure 5: Annual energy use comparison of TE vs. VAV system, in various climate zones. Source: (Author 2021)

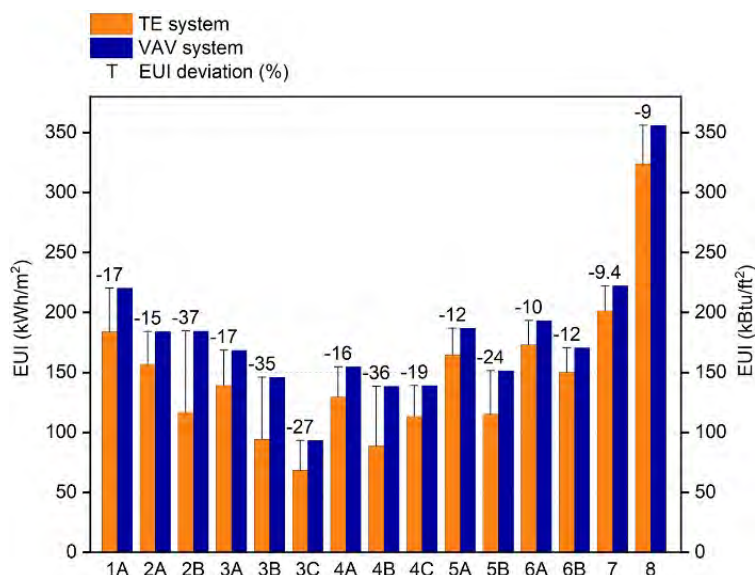

Figure 6: EUI comparison between the two systems in various climate zones. Source: (Author 2021)

CONCLUSION

The results of the current and previous research indicated that TE materials are promising active components that can be used in facade assemblies for localized heating and cooling purposes. TE system is an independent system that solely operates based on the temperature differences between the internal and external environments, containing no moving parts or harmful substances. Utilizing the temperature differences, TEs can warm up in heating mode and absorb heat in cooling mode. Compared to the conventional HVAC systems, maintenance of TE systems is easier due to the modularity of their components. Moreover, occupants of each room within the same building can use the system based on their personal preferences.

Energy modeling results, performed for various climate zones, showed reduction in energy use and improved performance of TE systems, compared to conventional VAV system. It was concluded that TE system was more energy efficient in all climate zones and conditions, compared to the VAV system. Regardless of the climate zones, monthly and annual energy usage (i.e., electricity, fuel, and HVAC auxiliary) of the TE facade system was lower than that of VAV system.

The developed TE system shows a promising direction for intelligent, active facades that react to environmental conditions and can be used for localized heating and cooling. Future studies will investigate and test full-scale facade mock-ups that integrate TE modules, with the objective to evaluate their thermal performances.

REFERENCES

- Aksamija, A., Z. Aksamija, M. Farid Mohajer, G. Vigneau and M. Upadhyaya. 2020. Thermoelectric facades: simulation of heating and cooling potential for novel intelligent facades. *Facade Tectonics 2020 World Conference*. Los Angeles (US), 5-27 August 2020.
- Aksamija, A., Z. Aksamija, C. Counihan, D. Brown and M. Upadhyaya. 2019. Experimental study of operating conditions and integration of thermoelectric materials in facade systems. *Frontiers in Energy Research: Special Issue on New Materials and Design of the Building Enclosure*. Article 6.
- Boukai, A. I., Y. Bunimovich, J. Tahir-Kheli, J. Kan Yu, W. A. Goddard and J. R. Goddard. 2008. Silicon nanowires as efficient thermoelectric materials. *Nature* 451 (7175), 168–71.
- Ibanez-Puy M., J. A. S. Fernandez, C. Martin-Gomez and M. Vidaurre-Arbizu. 2015. Development and construction of a thermoelectric active facade module. *Facade Design and Engineering* 3, 15-25.
- Montecucco A., J. Buckle, and A. Knox. 2012. Solution to the 1-D unsteady heat conduction equation with internal joule heat generation for thermoelectric devices. *Applied Thermal Engineering* 35 (1), 177–84.
- Snyder, G. J. and E. S. Toberer. 2008. Complex thermoelectric materials. *Nature Materials* 7 (2), 105–14.
- Upadhyaya M., S. N. Khatami, Z. Khatami (2015). Engineering thermal transport in SiGe-based nanostructures for thermoelectric applications. *Journal of Materials Research* 30 (17), 2649–62.

Building with Air: The Internet of Things (IoT) as a Pedagogical Tool for Design-Build Education

Nate Imai¹

¹Texas Tech University, Lubbock, TX



Opening Figure: In this investigation the Internet of Things (IoT) serves as a pedagogical tool for allowing students to experience changes in temperature, wind speed, and humidity through shifts in hue, saturation, and brightness. Source: (Author 2019).

ABSTRACT: How can we teach design and building performance as an integrated process to instill principles of resilience in our next generation of architectural designers? Through the analysis of a project that integrates temperature, wind speed, and humidity data in the design of a passively heated and cooled interactive installation, this paper proposes methods for leveraging the Internet of Things (IoT) to make tangible the relationship between buildings and their environments. By combining sensor data with the experience of building, the paper examines how IoT can serve as a pedagogical tool for students to learn, understand, and apply building performance concepts in their architectural designs. This paper investigates the growing field of IoT, detailing its current applications and future opportunities for impacting architectural research and practice. It next covers the methods and results of a one-semester design-build project that incorporates IoT technology in the construction of a digitally fabricated tea house to create a feedback loop for students to understand the performance of their built structure. The research outcomes of this investigation are two-fold: 1) the development of a method for translating real time sensor and web data into microcontroller outputs for creating an interactive interface, and 2) a pedagogical model for teaching design and building performance as an integrated process by combining IoT technology with design-build projects. By teaching design and building performance as an integrated process through an experience-centered approach, this paper argues students can better understand and apply performance concepts in their architectural designs to help achieve our goals for urban resilience.

KEYWORDS: Digital Design and Practices, Design-Build, Interactive Architecture, Computational Design, Internet of Things

INTRODUCTION

The growing complexity of architectural practice asks us to reevaluate our approaches to educating students in preparation for an evolving discipline. The increasing demand for building performance; the large role building systems and technologies play in the design, development, and construction process; the growing number of consultants and contractors needed to collaborate with; and the expanding suite of software and digital design tools makes the task of educating contemporary architecture students a challenging endeavor. By teaching design and building technology in isolation from one another, content is abstracted and students' opportunities to understand "why" certain technologies and methods are implemented in practice are curtailed.

To bridge the existing divide between design and evaluation, this paper advocates for an experiential approach to learning to address the diverse and growing responsibilities of practitioners in the discipline today. This sentiment is reflected by contemporary educators such as Kiel Moe's call for "integrated design" (Moe 2008) and Tricia Stuth's "designbuild-and-evaluate" (Stuth 2017) approach that frame the act of design and assessment as an interrelated process. Through a project that teaches students fundamentals on building performance, this investigation leverages the Internet of Things (IoT) as a pedagogical tool for deepening students' cognitive understanding of the structures they design and build through the framework of experience.

1.0 CONTEXT

This investigation asks the question: "how can IoT technologies be leveraged as a pedagogical tool for students to learn, understand, and apply concepts related to building performance in their architectural designs?" While IoT is advancing at a rapid rate and becoming increasingly present in our built environment, its application in design education remains untested and limited. This paper envisions IoT, with its capacity to interface with buildings and their environments, as an asset for helping students learn, understand, and apply building performance concepts in their architectural designs. By integrating IoT with design-build projects, students can understand building performance concepts through the process of making and building.

Defined as "'things' or 'objects' that connect to the internet" by Samuel Greengard in his book, *The Internet of Things*, IoT's value lies in connecting "physical-first products and items to each other as well as connecting them to digital-first devices" (Greengard 2015). Beginning in 2007 with Apple's introduction of the iPhone and its sale of approximately 37 million units in 2008, IoT is poised for an era of rapid expansion and application within our built environment (Greengard 2015). IoT machine to machine communication (M2M) devices are expected to grow from 6.1 billion in 2018 to 14.7 billion by 2023, with home applications predicted to represent 48 percent of all connections by 2023 and connected cities applications slated to have the second-fastest growth (26 CAGR) over the six-year period (Cisco 2020).

The proliferation of IoT smart devices in the built environment has provided new opportunities for understanding how our cities perform through the large-scale collection of data. The term "smart cities" provides a framework for addressing issues related to resilience at an urban level, as reflected by architectural historian Antoine Picon (2015) who identifies "sustainable development" as a central point of focus and poses the question "is it possible to speak of smart cities if urban zones continue...to contribute to environmental degradation?" If smart cities represent an optimistic vision on the role technology may play in outlining strategies for resilience, recent discourse amongst architects and urbanists provides more critical and rigorous methods for realizing these cities' potential. Allen Sayegh and Harvard's Responsive Environments and Artifacts Lab's (REAL) (2021) concept of "responsive environments" serves as a counterpoint to smart cities' top-down and optimized approach and focuses on the intersection of architecture and urbanism to develop ways for integrating emerging technologies such as IoT into cities and exploring the dynamic relationship between physical and digital spaces. Through responsive environments, resilience can be framed as being achieved through bottom-up processes, especially those that involve designing the ways in which smart technologies are integrated into the built environment. Such moments of integration not only provide a higher resolution picture of how our cities perform, but also the potential to reveal new architectural meaning latent within our buildings and environments.

Taken within the context of architecture schools, this paper frames IoT as a pedagogical opportunity frame the processes of design and performance evaluation as an interrelated process through the creation of real-time feedback loops that, when applied at scale, have the potential to enhance resilience at architectural and urban scales. As a means for integrating IoT in the design-build process, this investigation identifies microcontrollers as a suitable platform for learning and understanding how buildings perform. Microcontrollers are a familiar technology in architecture schools with a robust community of users to draw upon and learn from. They provide an ideal tool for experimenting and prototyping IoT setups and are customizable to address the specific demands of design-build projects. The arrival of Wi-Fi-enabled microcontrollers in recent years has provided designers a gateway to engage in the world of IoT. No longer inhibited by a need for a computer connection, this generation of microcontrollers allow users to monitor and relay environmental conditions across distributed networks and at a variety of scales.

In focusing on the emerging potential of IoT, the intention of this paper is not to advocate for a shift towards a utilitarian application of technology or vocational attitude in design education, but rather identifying a currently underutilized tool to enhance student cognition through the framework of experience. By leveraging IoT as a pedagogical opportunity for learning, understanding, and applying disciplinary concepts through the act of making and building, this investigation promotes a student-centered model for engaging the growing complexity of architectural practice.

2.0 METHODOLOGY

[Project Name Redacted] is an installation that explores the pedagogical potential of IoT to allow students to study thermodynamic principles through their architectural designs. This project was designed, fabricated, and constructed with undergraduate and graduate students at [Institution Name Redacted]. The installation integrates computer coding, Wi-Fi enabled microcontrollers, and sensor data with digital fabrication techniques and construction methods to produce

a space that allows visitors to understand thermodynamic principles through their interactions with the structure. The methods used to create this installation serve to teach students thermal concepts, digital fabrication techniques, and construction logics through the process of making and building.

The project is designed as a feedback loop for understanding thermodynamic principles through an interactive space that makes tangible for visitors the temperature, wind speed, and humidity of the air around them. The installation's feedback system combines sensors, weather data, and addressable LED lights to communicate thermal conditions by comparing and contrasting building interiors with their exterior environment. In a three-step process, sensor data collected at the ventilation openings is measured in relation to local weather data and translated in the form of light. Using hue, saturation, and brightness to communicate differences in temperature, wind speed, and humidity respectively, the system creates a qualitative interface for understanding quantitative differences within the space.

[Project Name Redacted] is an 84 square-foot tea house that leverages intelligence gained through the integration of IoT to reduce material excess and eliminate the use of active building systems. (4) air inlets at the corners of the floor and door and (2) along the roof ridge induce natural ventilation flows within the space through a stack-effect (Figure 1). Movable furniture and the doorway located at the corners create a system for modulating airflow through the interior. By understanding and applying thermal principles through reading the lights and arranging the furniture, occupants can regulate their thermal comfort through their interactions with the structure (Figure 2).

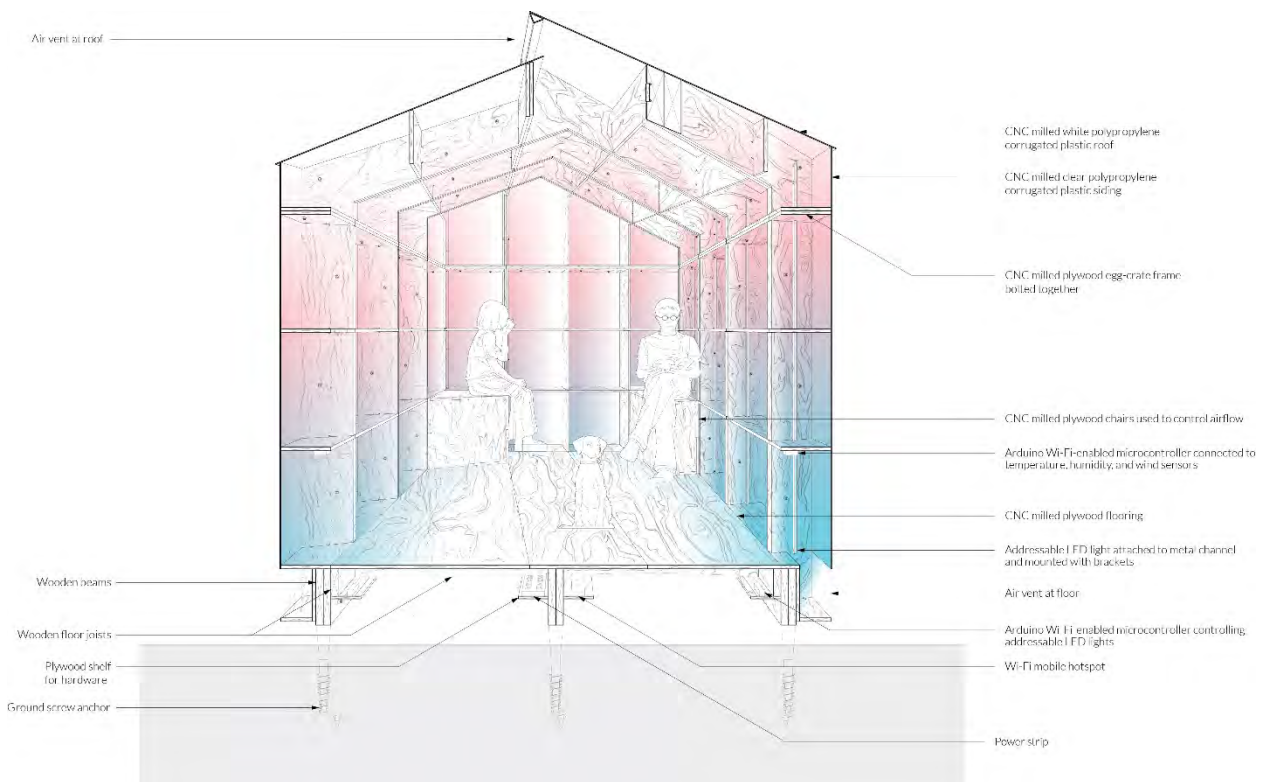

Figure 1: Openings at the floor and along the roof ridge induce natural ventilation through the space. Source: (Matthew Conway + Author 2019)

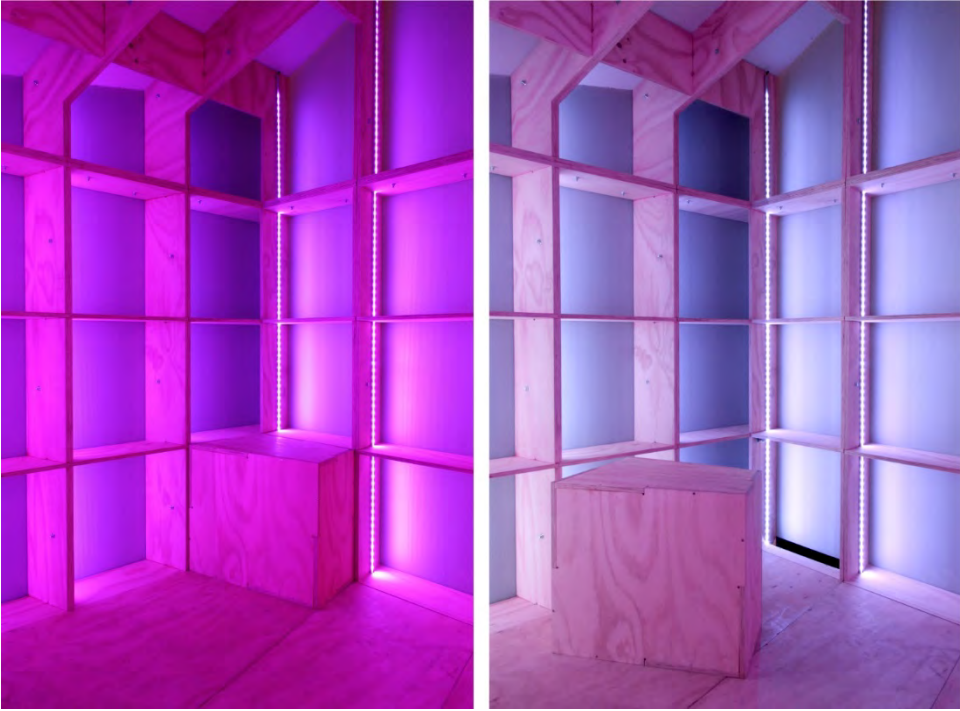

Figure 2: Movable furniture can restrict airflow by being positioned at the corners (left) or induce it by being positioned further away (right). Source: (Author 2019)

2.1. Translating Weather and Sensor Data to LED Lights

To represent the thermal conditions within the installation in real-time, addressable LED lights are used to communicate the temperature, wind speed, and humidity of the air within the space. The process of translating thermal sensor data is a three-part process: 1) Wi-Fi-enabled microcontrollers connected to sensors monitor temperature, wind speed, and humidity conditions while a JavaScript code parses local weather information from the publicly accessible website OpenWeatherMap, 2) an MQ Telemetry Transport (MQTT) platform shares the parsed data with Wi-Fi enabled Arduinos connected to addressable LED lights, and 3) the Arduino microcontrollers operate the LED lights to communicate the data through changes in hue, saturation, and brightness (Figure 3).

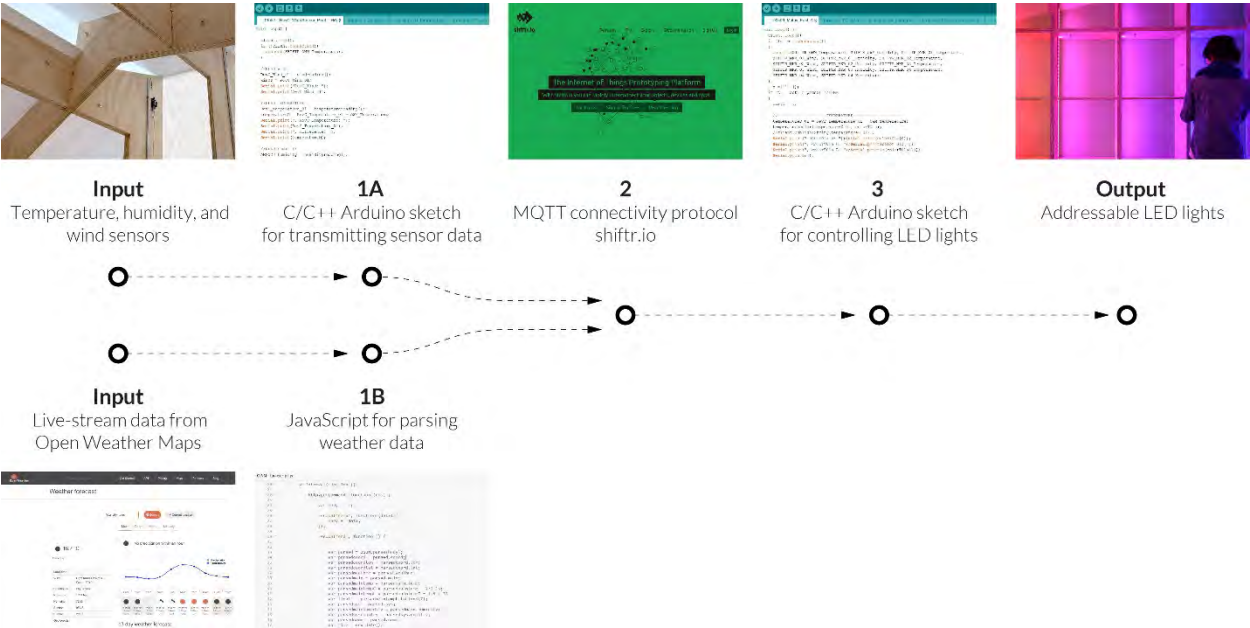

Figure 3: Sensor data collected at the ventilation openings is measured in relation to local weather data and translated into lights through a three-step process. Source: (Author 2019)

2.2. Collecting Temperature, Wind Speed, and Humidity Data

Arduino MKR1000 microcontrollers are used for their Wi-Fi capacity and compact size. (6) MKR1000s are each connected to an AM 2320 digital temperature and humidity sensor and a Modern Device Rev C. wind sensor. C/C++ sketches written using Arduino's Integrated Development Environment (IDE) gather data generated by the sensors.

Simultaneously, local weather data is collected from OpenWeatherMap to calculate the temperature difference between the installation's interior and the exterior environment. OpenWeatherMap allows local temperature data to be publicly accessible through their Application Programming Interface (API) in the form of a JavaScript Object Notification (JSON). A JavaScript code parses the JSON and returns the local temperature in Fahrenheit degrees. The JavaScript code is executed on a Wi-Fi-enabled Raspberry Pi Zero using the JavaScript runtime environment Node.js (Node.js n.d.).

2.3. Using MQTT to Connect JavaScript and C/C++ Arduino Devices

An MQTT machine to machine (M2M) IoT connectivity protocol is used to network Arduino devices running C/C++ and the Raspberry Pi Zero running JavaScript (MQTT n.d.). The IoT prototyping platform shiftr.io was selected for its capacity to connect JavaScript and Arduino devices and its visual interface that shows these connections in real-time (Shiftr.io n.d.). This platform permits (15) devices to be connected simultaneously: (6) Wi-Fi-enabled MKR1000s connected to AM 2320 digital temperature and humidity sensors and Rev C. wind sensors, (1) Wi-Fi-enabled Raspberry Pi Zero running the JavaScript code, and (8) Wi-Fi-enabled MKR1000s operating addressable LED lights.

2.4. Controlling Addressable LED Lights

(8) MKR1000s each control (2) strips of WS2812B "NeoPixel" addressable LED lights with strips running between 11 to 87 pixels in length depending upon the height of the facade. Each facade contains (4) strips of LED lights operated by (2) MKR1000s. C/C++ sketches written using Arduino's IDE translate temperature, wind speed, and humidity data as changes in hue, saturation, and brightness respectively. For changes in temperature, the sketch calculates the difference between sensor data and the local weather temperature to communicate the relationship between interior and exterior conditions. A warmer interior temperature results in a red hue, whereas a cooler interior temperature results in a blue hue. For changes in wind speed, no airflow results in no change to the lights' color, whereas increased airflow results in a desaturated white color. For changes in humidity, low humidity results in decreased brightness, whereas high humidity results in increased brightness.

The sketch calculates the data gathered from each sensor location and translates the quantitative values into a qualitative gradient of lights (Figure 4). East and west facades create a gradient from (4) sensor locations: (2) along the roof ridge and (2) at the floor corners and door. North and south facades create a gradient from (3) sensor locations: (1) along the roof ridge and (2) at the floor corners and door. The result is an interface that provides continuous feedback on the installation's thermodynamics through constantly updating lights. By studying the lighting patterns and arranging the movable furniture and door, occupants can understand and apply stack-effect principles through their interactions and experience within the space.

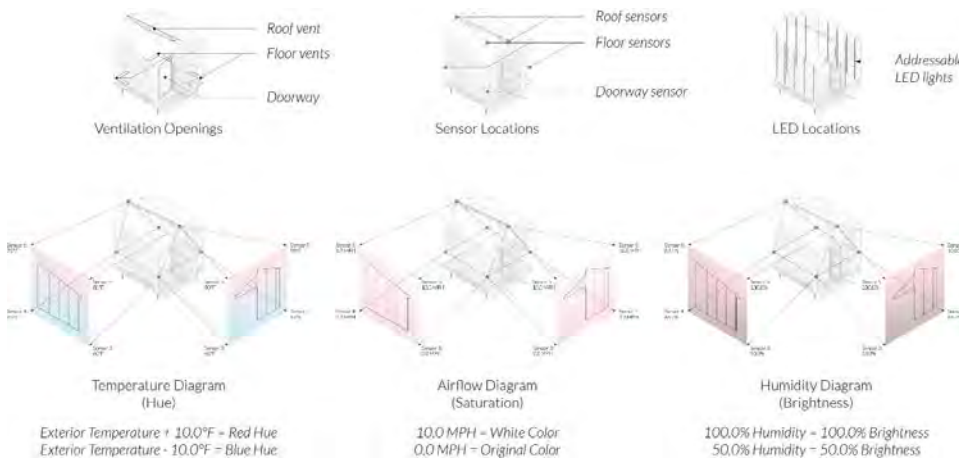

Figure 4: Differences in temperature, wind speed, and humidity are registered as shifts in the lights' hue, saturation, and brightness, respectively. Source: (Author 2019)

3.0 DESIGN PEDAGOGY

The installation was realized through a one-semester seminar course that sought to leverage IoT technology as a pedagogical tool to teach thermodynamic concepts through the process of making and building. The class was composed of eleven students—six undergraduate and five graduate students from [Institution Name Redacted].

Students worked on the design development, fabrication, and construction of the 1:1 scale tea house to be installed on campus and at the local botanical garden and arboretum. Students at the outset of the semester were subdivided into four teams—material research, digital fabrication, lighting design, and computer coding—that worked collaboratively to develop the project as synthetic whole. The teamwork was split into three parts over the course of the semester: research, design, and fabrication and construction. Students worked on specific aspects of the project in depth within their specific teams and coordinated with other teams in the design, development, and construction of the installation.

The structure's modular design allows for it to be constructed in a single day (Figure 5). The process of assembling and disassembling the structure for installation at [Institution Name Redacted] and the local botanical garden and arboretum not only reinforced students' conceptual understanding of the project's fabrication and construction logics, but also allowed them to evaluate its performance in two distinct environmental conditions (Figure 6).

By seeing the project through from beginning to end, students were able to fully comprehend the installation's conceptual and design intent. Each student was introduced to the project's code on the first day of class, and their familiarity with the IoT technology behind the installation not only allowed them to understand the inner workings of the tea house, but also develop an experiential understanding of the thermal principles that inform design decisions in practice.

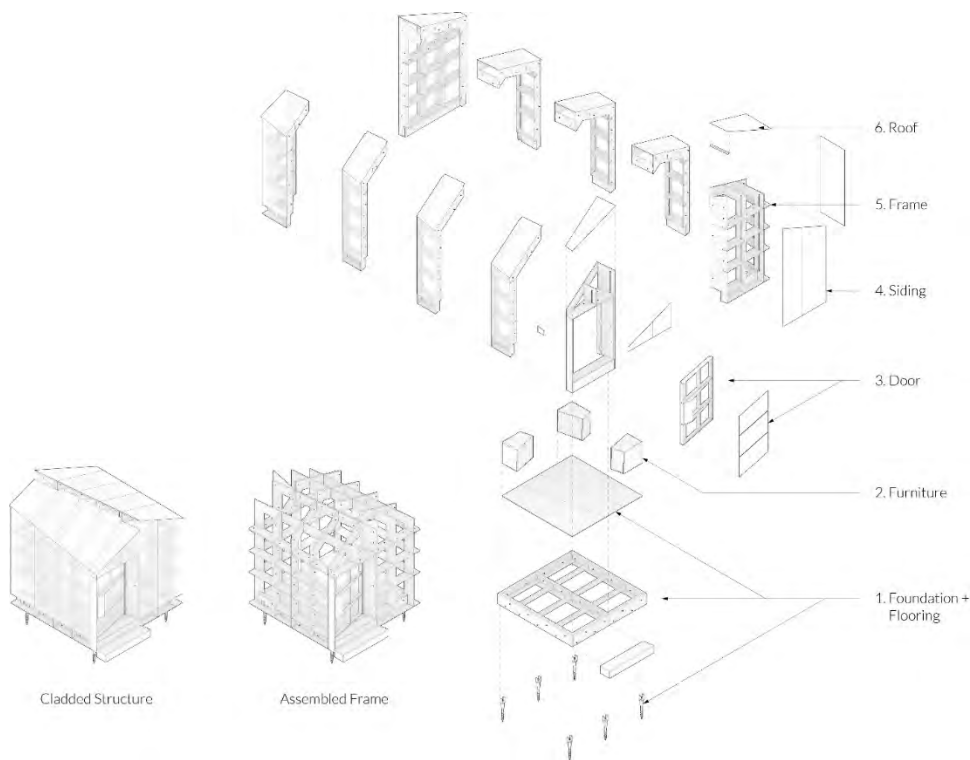

Figure 5: The project combines traditional wood framing and digital fabrication methods to develop a construction system that is modular and designed for disassembly. Source: (Author 2019)



Figure 6: The process of disassembling and reassembling the structure for installation reinforced students' conceptual understanding of the project's fabrication and construction logics. Source: (Author 2019)

4.0 DISCUSSION

Incorporating IoT in the design-build process provides students a pedagogical scaffold for not only understanding how buildings are designed and constructed but also how they perform. Through a pedagogy that emphasizes an experiential approach to learning, this course provides a model for engaging with the growing complexity of the architectural profession today. By integrating topics such as IoT, thermodynamics, fabrication techniques, and construction methods, students are able to draw connections in their education and apply learned concepts through the process of making and building. The integration of IoT into the design process has three observed outcomes: 1) it allows students to understand their environments in quantitative and qualitative terms, 2) the continuous feedback provided by IoT allows students to constantly test hypotheses, evaluate results, and apply learned concepts in their designs, and 3) it provides a framework for students to evaluate and apply their designs at multiple scales.

This investigation sees opportunities to expand upon the project in two ways. The first proposed application is the integration of the project's sensor data with a digital model to produce a "digital twin." Defined as "a dynamic virtual representation of a physical object or system" (Stanford-Clark et al. 2019), digital twins can provide students a real-time digital representation of their built structures that can be used for further analysis. By using data communication plugins such as gHowl for Grasshopper to integrate sensor data, students can engage with digital modeling software not only as a tool for design but also performance evaluation (Grasshopper n.d.). The second proposed application is the further development of the light-weight construction methods utilized in this design-build installation for application in small-scale domestic projects. Referencing UCLA cityLAB's research on Backyard Homes (2010), this investigation sees potential in integrating IoT in the design of lightweight Additional Dwelling Units (ADUs) to address cities housing issues while minimizing the environmental impact of construction. As a housing solution that can add density to a variety of urban conditions and across multiple cities, intelligently designed ADUs that leverage IoT to eliminate material excess can have a profound impact on achieving urban resilience moving forward.

In addition to these future applications, an additional observed pedagogical outcome from this course structure was the active role students took in their design education. For many of the participating students this course served as an introduction to working with microcontrollers, sensors, coding, laser cutting, CNC milling, and vacuum forming. The experiential and project-based approach of the class provided a framework for students to learn, understand, and apply these technologies to their designs. Furthermore, the need to collaborate with each other and coordinate with outside vendors, consultants, and clients gave students experience and confidence to engage the numerous collaborators necessary to practice in today's professional environment.

5.0 CONCLUSION

This investigation proposes a methodology for leveraging IoT as a pedagogical tool for students to learn, understand, and apply concepts related to building performance in their architectural designs. By leveraging IoT to create informative feedback loops between design and performance, architecture schools can provide students a pedagogical scaffold to understand and apply lessons from their education through a teaching approach centered on personal experience.

IoT technology allows students the opportunity to test hypotheses, evaluate results, and apply learned concepts in their designs through scalable networks that provide constant qualitative and quantitative feedback. Combined with the design-build model, IoT is a potent tool for teaching students abstract technical concepts typically isolated from the design process in architecture education. By leveraging IoT to create interactive and tangible interfaces, students can engage their environments to learn, understand, and apply building performance concepts such as thermodynamics through the framework of experience.

Beyond its utilitarian application, the Internet of Things is an impactful pedagogical tool for building intelligence within our students of architecture. By increasing students' cognitive ability through a framework that allows students to learn, understand, and apply building performance concepts in their architectural designs, we can better prepare the next generation of practitioners to engage issues of resilience that impact our cities now and in the future.



Closing Figure: By engaging local contexts and conditions, IoT provides architecture educators a pedagogical tool for teaching building performance principles through the framework of experience. Source: (Author 2019)

REFERENCES

- Cisco. "Cisco Annual Internet Report (2018-2023)." March 9, 2020, <https://www.cisco.com/c/en/us/solutions/collateral/executive-perspectives/annual-internet-report/white-paper-c11-741490.pdf>.
- cityLAB. *Backyard Homes*. Los Angeles: cityLAB, 2010.
- Greengard, Samuel. *The Internet of Things*. Cambridge: MIT Press, 2015.
- Moe, Kiel. *Integrated Design in Contemporary Architecture*. New York: Princeton Architectural Press, 2008.
- MQTT. "MQTT.org." Accessed January 15, 2021. <http://mqtt.org/>.
- Node.js. "Node.js." Accessed January 15, 2021. <https://nodejs.org/en/>.
- Picon, Antoine. *Smart Cities : A Spatialised Intelligence*. Chichester, England: Wiley, 2015.
- Sayegh, Allen, Stefano Andreani, Matteo Kalchschmidt, Edith Ackermann, Isa He, and REAL Lab. *Responsive Environments : An Interdisciplinary Manifesto on Design, Technology and the Human Experience*. New York, NY: Actar, 2021.
- Shiftr.io. "Shiftr.io." Accessed January 15, 2021. <https://shiftr.io/>.
- Stanford-Clark, Andy, Erwin Frank-Schultz, and Martin Harris. "What are digital twins?" IBM Developer, November 14, 2019. <https://developer.ibm.com/technologies/iot/articles/what-are-digital-twins/>.
- Stuth, Tricia. "Second Nature: Embedded Knowledge through Designbuild Education." In *Designbuild Education*, edited by Chad Kraus. New York: Routledge, 2017.
- Grasshopper. "gHowl." Accessed January 15, 2021. <https://www.grasshopper3d.com/group/ghowl>.

Exploring Low-cost Acoustic Panels with Origami Patterns for Classrooms

Julio C. Diarte¹, Elena M. Vazquez²

¹Pennsylvania State University, State College, PA

²Universidad Nacional de Asuncion, San Lorenzo, PARAGUAY

ABSTRACT: The goal of the work presented in this paper was to provide an alternative method to improve the acoustic conditions of classrooms in public schools in low-income contexts by designing, fabricating, and testing low-cost and modular acoustic panels. The panels used are shaped with Origami-patterns, and they were made of waste cardboard sheets collected from the urban waste stream. The exploratory work combined physical prototyping and simulation using Pachyderm, an acoustic simulation plugin for Rhinoceros-Grasshopper. While prototyping focused on assessing fabrication workflow, simulation focused on determining Reverberation time of three types of three-layered Origami-based panels. Fabrication results showed that all panels were easy to produce with simple tools. The simulation confirmed that panels with a denser pattern decreased Reverberation time between 27% to 48% for 125, 250, and 500 Hz frequencies. Further research will explore increasing panels layers and adding alternative and recycled materials to test sound absorption. The solution presents promising results for low-income contexts with a high need to improve the physical conditions of classrooms and other buildings.

KEYWORDS: Waste Cardboard, Origami, Acoustic Insulation, Classrooms

INTRODUCTION

Climate change challenges everyone to create innovative and more affordable ways to increase buildings resiliency. This challenge is challenging for those living in low-income contexts which cannot afford to build using conventional and high-quality materials. The study described in this paper is part of research that explores waste cardboard applications for architecture and provides guidelines to design and fabricate low-cost and modular insulation panels using Origami patterns and waste cardboard sheets as the primary material.

The goal is to improve the acoustic performance of classrooms in primary public schools in developing countries, commonly characterized by poor internal conditions. A primary public school located in Paraguay was selected as the case study selected for the exploration. The school represents a common case of building that requires substantial improvements in the physical infrastructure to help children improve their education environment.

The work is based on two strands of research. There is a body of literature that investigates Origami patterns for structural and non-structural purposes including acoustic panels, such as the work by Turco et al. (2017). There is also work by Kang et al. (2021) where researchers proposed multi-layered and perforated flat cardboard panels to improve acoustic performance of housing apartments in Seoul.

In this work, we followed a mixed-method approach combining prototyping and simulation. In the first part, the authors designed panel templates using the Miura-ori pattern –one of the simplest and more common Origami patterns. The digital templates were used to test the fabrication process and perform simulation using the Pachyderm Acoustical Simulation for Rhino Grasshopper. Simulation evaluated the Reverberation time of designed panels, and the results allowed to obtain adequate design parameters for prototypes improvement.

We conclude that using waste cardboard sheets obtained from urban waste and fabricated following an Origami pattern can work for acoustic panels. The guidelines offered in this work are intended for both professionals and laypeople who have access to waste cardboard and need low-cost alternatives to improve the acoustic conditions of classrooms. Future work will focus on housing in similar socio-economical contexts that require improvements to fulfill acoustic requirements. The study contributes to the growing body of research that utilizes smart geometries for architectural applications and studies exploring sustainable materials to mitigate buildings' impact on climate change.

1.0 BACKGROUND

The background information that supports the project is presented in three parts. The first part contextualizes the situation of primary public schools in Paraguay, where there is an urgent need to improve classrooms infrastructure where acoustical conditions are an overlooked issue. The second part comments on recent advances in Cardboard Architecture, highlighting the opportunities to use this material. The third part provides a brief overview of Origami engineering and why this geometry is helpful for acoustic panels.

Paraguay suffers one of the highest deficits in educational building infrastructure in Latin America, negatively impacting the educational development of children between 5-14 who attend public schools (Murillo and Román 2011). The deficit is both quantitative and qualitative, seriously affecting rural areas where public primary schools do not have enough classrooms and suffer from problems in the structure of buildings (Yanes-Pagans, Bedoya, and Zarza 2018). As an example of local efforts to improve the current situation, Mauricio Villalba, an architect from Paraguay, worked on a project that sought to improve the physical conditions and thermal performance of roofs in public primary schools in rural areas (Villalba 2021). Simulations on the thermal performance of the lightweight and modular roof system proposed by Villalba indeed showed improvements in the indoor conditions of classrooms that currently do not have any thermal insulation. However, there are no ongoing projects that look at the acoustic conditions of classrooms in rural schools considering there is no treatment whatsoever in existing buildings. In this context, this work aims to contribute to local efforts by proposing a low-cost and lightweight acoustic panel system made of waste corrugated cardboard that can be easy to fabricate, transport, assembly, and recyclable. The acoustic condition addressed in this work is Reverberation time.

Recent published architectural research about acoustical conditions of multi-use educational spaces pointed out the importance of acoustical qualities to support better learning (Butko 2021). Butko proposed porous concrete material as an alternative to improve absorption and diffusion qualities of spaces where users manifested acoustical issues. Absorption and diffusion are essential to assuring good communication in educational spaces, and designers commonly use materials such as wood or foam panels to tackle these issues. Although Butko's research reported improved speech legibility, clarity, and sound reflection, porous concrete materials could be costly for low-income contexts and challenging to transport to remote areas.

Cardboard materials are paper-based products that are not typically used in building design. Nevertheless, work by Shigeru Ban has increasingly brought attention to the material since the 1990s, showing the potential of cardboard in works such as the Nomadic Museum in various locations (2005), the Cardboard Cathedral in New Zealand (2013), and the Concert Hall in France (2017). In the Concert Hall, the architect used paper-based materials as acoustic elements creating a warm and intimate spatial character. A recent publication by the author on Cardboard Architecture has drawn attention to the use of cardboard products during the last eight decades as both structural and non-structural building components (Author, 2021). The review summarized research into cardboard architecture in academia and professional practice, identifying different cardboard structural systems such as active vector and active surface structures. The main advantage of using cardboard as a building material is its low cost, relatively good mechanical properties, and ease of recycling (Latka 2017). In terms of applications in building construction, cardboard can be used in several ways, for instance, to build formwork for casting panels (Authors, Year) or make tubes for chairs and furniture, as seen in the work of Shigeru Ban.

Cardboard can also be used for making panels for thermal and acoustic insulation for buildings. A group of studies has found positive results in terms of performance and cost. Asdrubali et al. (2015), for example, measured transmission loss and thermal conductivity and reported that cardboard works for light thermal insulation panels for non-structural and internal partitions. Similarly, a comprehensive review on insulation materials that compare conventional, alternative, and advanced insulation materials (Schiavoni et al. 2016) pointed out that although sound absorption results are unfavorable due to its inner structure, cardboard is a remarkable material for sound insulation. Two other seminal works for this project investigated sound absorption and insulation performance of perforated and non-perforated cardboard panels, including panels with multi-frequency resonators reporting excellent results as stated by the authors (C. W. Kang and Seo 2018; C.-W. Kang, Kim, and Jang 2021). In these works, authors tested flat panels made of three corrugated cardboard sheets with different perforation configurations for housing purposes.

Origami is a craft technique that is concerned with folding paper. This is a method for creating three-dimensional structures from flat surfaces, appealing for engineering applications. A comprehensive review by Sorguc et al. (2009) describes origami applications in architecture and how the technique can be a medium for inquiry in design. Regarding Origami patterns, the design is typical for structural components and panels. Designers commonly use Origami patterns because they are simple and effective in fabricating rigid elements with flat materials, facilitating a minimum number of elements, and being easy to transport (Gattas and You 2016). In this sense, the work by Turco et al. (2017) applied Origami techniques for adjustable acoustic panels made of cardboard and wood to fit acoustic and visual requirements. Their results showed that shape variation and size increase could improve acoustic panels' scattering/diffusing properties at lower frequencies. Another remarkable precedent that used Origami patterns for acoustic panels developed a computational method to integrate design and acoustic engineering, including parametric design, acoustic simulation, and optimization (Takeanada and Okabe 2013).

The work presented in this paper adds to the literature on Cardboard Architecture by exploring Miura-ori origami patterns with different design variables to build acoustic panels using waste cardboard sheets. Furthermore, it uses a case study of primary schools in rural areas to argue that these origami acoustic panels could be an economical way of improving the performance of such buildings.

2.0 METHODS

2.1 Design and Prototyping

In this project, design variables for acoustic panels included Reverberation time (RT), modularity, cost, ease of fabrication, transportability, and recyclability. Acoustic performance variables include absorption and diffusion requirements. We focused on diffusion, specifically on RT measured in seconds, considering this is a crucial classroom issue. We relayed in previous research by Asdrubali et al. (2015) and Secchi et al. (2016) for sound transmission and sound insulation.

Modularity allows for adaptation to different uses in interior spaces of different dimensions (e.g., wall and/or ceiling). We intend to keep the system low-cost and easy to fabricate to help people with little money and little experience to obtain the materials and tools needed to produce the panels. In this case, we used sheets of waste cardboard that can be picked up for free from the streets and are free of contamination and in good shape, any cutting surface, knife, ruler, pencil, and conventional water-based glue. Water-based glue counts to make these panels easy to recycle or repurpose. The templates were created using parametric design software (Grasshopper); therefore, they can be generated in different shapes and dimensions as printed guidelines to facilitate the fabrication process.

2.2 Selected Case Study of Housing

In this paper, we adopted a case study methodology, where we designed and tested acoustic cardboard panels for a classroom for a primary public school in Paraguay. The room measures 7.2 x 7.2 meters and is 3 meters high (155.52 m³). The case study is a typical sample of a government-sponsored school in Paraguay, and Figure 1 illustrates the building layout. The school is built with concrete floors, brick masonry walls of 15 cm thick and no plastering, and corrugated steel panel roofs (no ceiling) supported with a steel structure. Classrooms have no thermal/acoustic insulation in the walls or under the roof. The room sizes define the design conditions for panel size and modularity, which is critical for efficiency and low costs. All doors are made of metal sheets, and windows have a single layer of tempered glass with metal framing. Studies reported poor quality conditions of classrooms physical conditions harming children's education and development (Murillo and Román 2011).

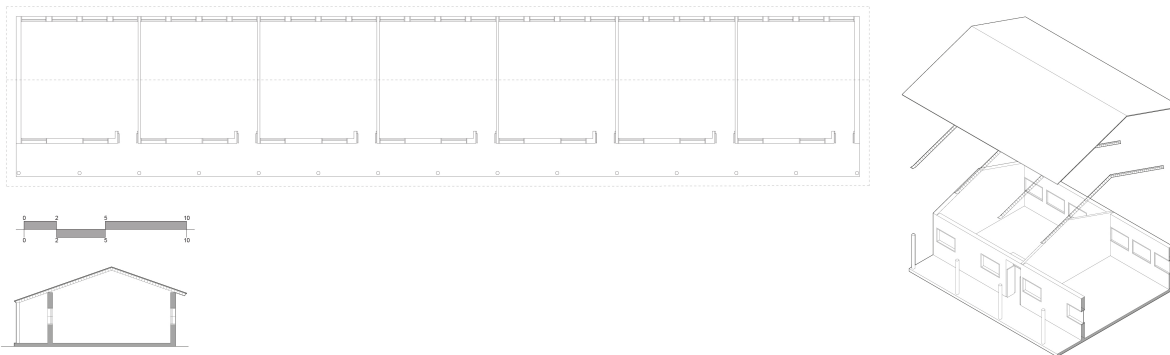

Figure 1: Floorplan, section, and partial axonometric view of a *Colegio Nacional Los Primeros Colonos del Chaco* new Loma Plata in the Chaco Region, Paraguay. Source: Mauricio Villalba

2.3 Simulation

In this research, we conducted a simulation study to assess the acoustic properties of the origami-shaped cardboard panels. While there are many indicators of acoustic performance, we focused on Reverberation time, measured in seconds, as this parameter is used in many standards, such as LEED and ANSI standard S12.50.2002. Reverberation time is defined as the time it takes for a sound to decay to a specified level, typically 60 dB. We used Pachyderm, an acoustic simulation plugin for Rhinoceros-Grasshopper, to measure the Reverberation time. This software can be used to predict noise and create a visualization of sound propagation, and it is intended to aid designers in developing spaces with good acoustic performance.

The simulation settings are shown in Figure 2. The basic simulation settings include defining a sound source and a receiver. These were set on opposite sides of the room. The interior walls were defined in the simulation as a standard indoor partition, and conventional materials were selected for the floor, walls, and roof. To simulate the acoustic performance of the cardboard panels, we obtained values for absorption coefficient from work by Kang, Kim, and Jang (2021). In a seminal study, the authors experimentally characterized the absorption coefficient of triple-layered-panels cardboard panels using the method of an impedance tube and calculated the noise-reduction coefficient. One limitation of the software we used is that it is difficult to make calculations using materials with exceptionally low absorption coefficients: the simulation tends not to converge since the sound takes too long to decay. We, therefore, are limited in the material selections for the simulation.

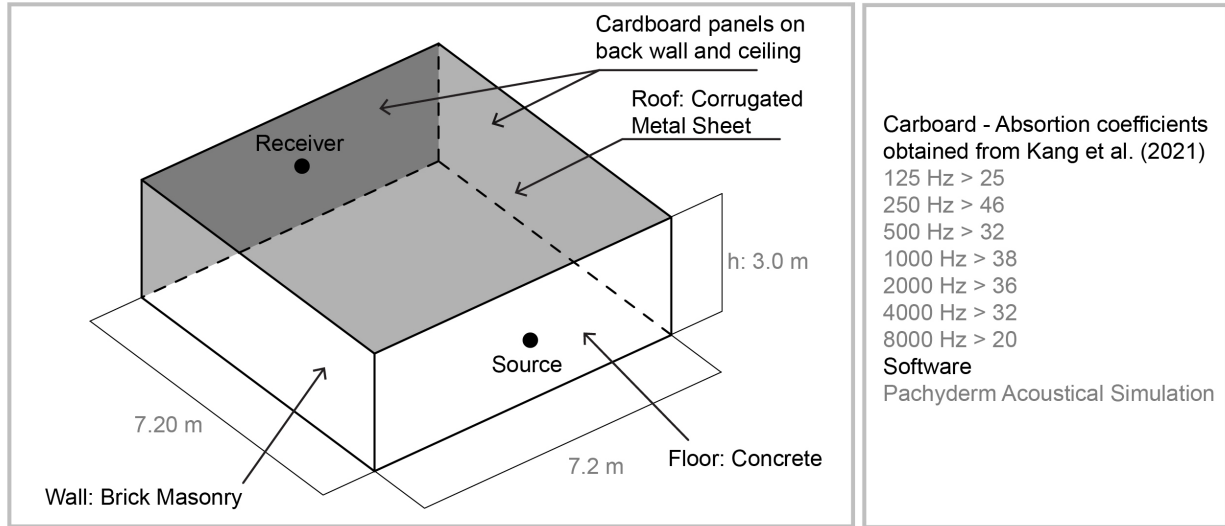

Figure 2: Simulation settings. Source: Authors

3.0 RESULTS

3.1 Fabrication

Figure 3.1 illustrates panel templates, modules, and finished panels. Templates include folding lines as mountains and valleys. All panels fit in a 457 x 812 mm frame for laser cutter fabrication; however, frame size can be adjusted to available cardboard sheets if necessary. We tested panels with large, medium, and small size modules to measure fabrication time. Figure 3.2 shows the prototype panels, each made with three layers of 3 mm thick sheets or single wall glued with a conventional water-based adhesive applied by hand with a spatula. The cutting time difference between panels is irrelevant if done with a laser cutter; nevertheless, the smaller the module, the more difficult it is to mount with time variation between 2-4 minutes for Panels 1 and 2 and 8-12 minutes for Panel 1. The work can be done entirely by hand, and although this will increase fabrication time, it will make the process low-tech and low-cost affordable for anyone or have access to the templates and material. We tested making perforations in Panel 3 following the same method used by Kang et al. (2021) 2.5 mm perforations were done quickly using an electric drill.

These panels can be attached to the wall or ceiling using adhesive strips, hot glue, or tape. The modularity facilitates their assembly, and they can be cut easily with a knife or handsaw to fit irregular spaces. Cardboard surface is easy to paint with either water-based or oil-based paint allowing households to use whatever they have at hand to decorate the panels.

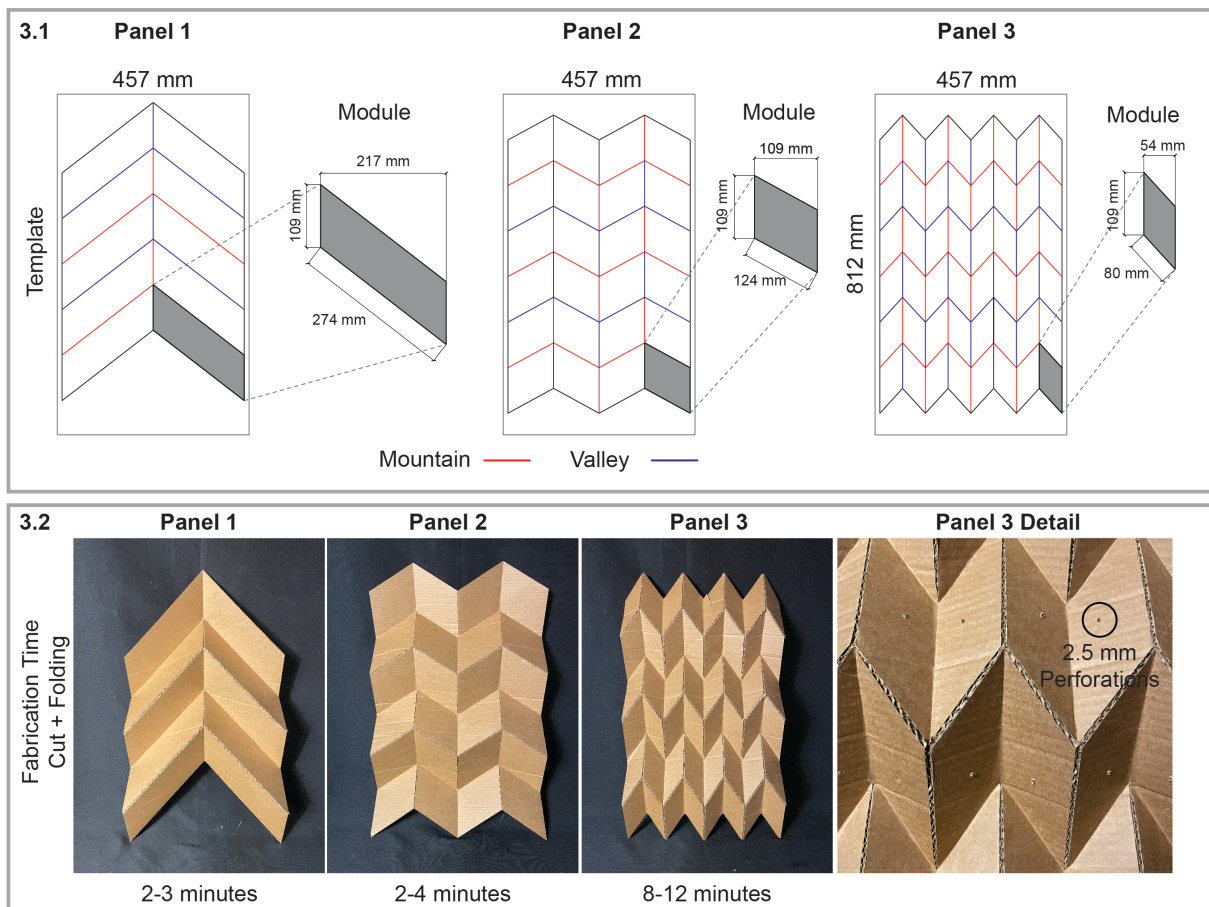

Figure 3: Templates and finished panels. Source: Authors

3.2 Simulation

Figure 4.1 shows a visualization of sound propagation in the room, with the left-hand side depicting the first moments and the right-hand side showing the sound waves as they reflect into the panels and the walls. The sound pressure simulation results are shown in Figure 4.2. We simulated the acoustic performance of a baseline case with no panel to assess how the introduction of the panels helped improve or not the acoustic performance. As shown in the graph depicting sound pressure levels (dB) vs. time in seconds, the panels overall help considerably improve the acoustic performance and decrease RT in the room. Overall, all panels present similar acoustic performance, with Panels 2 and 3 presenting the best performance. The reason might be related to their design, which has a denser pattern, which makes the sound waves diffuse more than the other prototypes. Panel 1 has the most 'open' Origami pattern; however, reverberation decreased -45%, -37%, and -22% for 125, 250, and 500 kHz wavelengths—speech frequency levels range. The table below Figure 4.2 compares the reverberation times for the three panels and the baseline case with no panel.

An interesting observation that emerges from the data comparison of the three panels and the baseline case is that there is not much of a difference in the acoustic performance of the different origami panels. Taken together, the simulation results indicate that there might be other characteristics that more greatly affect acoustic performance other than pattern design. These can be, for instance, material characteristics and layer count of the cardboard panels. One way that has been proven effective to improve the acoustic performance of cardboard panels is to make perforations into corrugated cardboard, as shown in a study by Kang et al. (2021). As shown in section 3.1, we tested fabricating non-perforated and perforated panels following the study; however, our simulation corresponds to non-perforated panels for now. Another alternative is increasing cardboard layers and arrangement of the cardboard panels, as proposed in an experimental study by Asdrubali et al. (2015). It is also possible to combine layers of cardboard with other recovered materials with high acoustic absorption, such as recycled paper, textiles (denim or towels), jute, or hemp fiber. Nevertheless, for the target case study of a classroom, the panels sufficiently improve the acoustic performance, and the results indicate that it is up to the abovementioned standards.

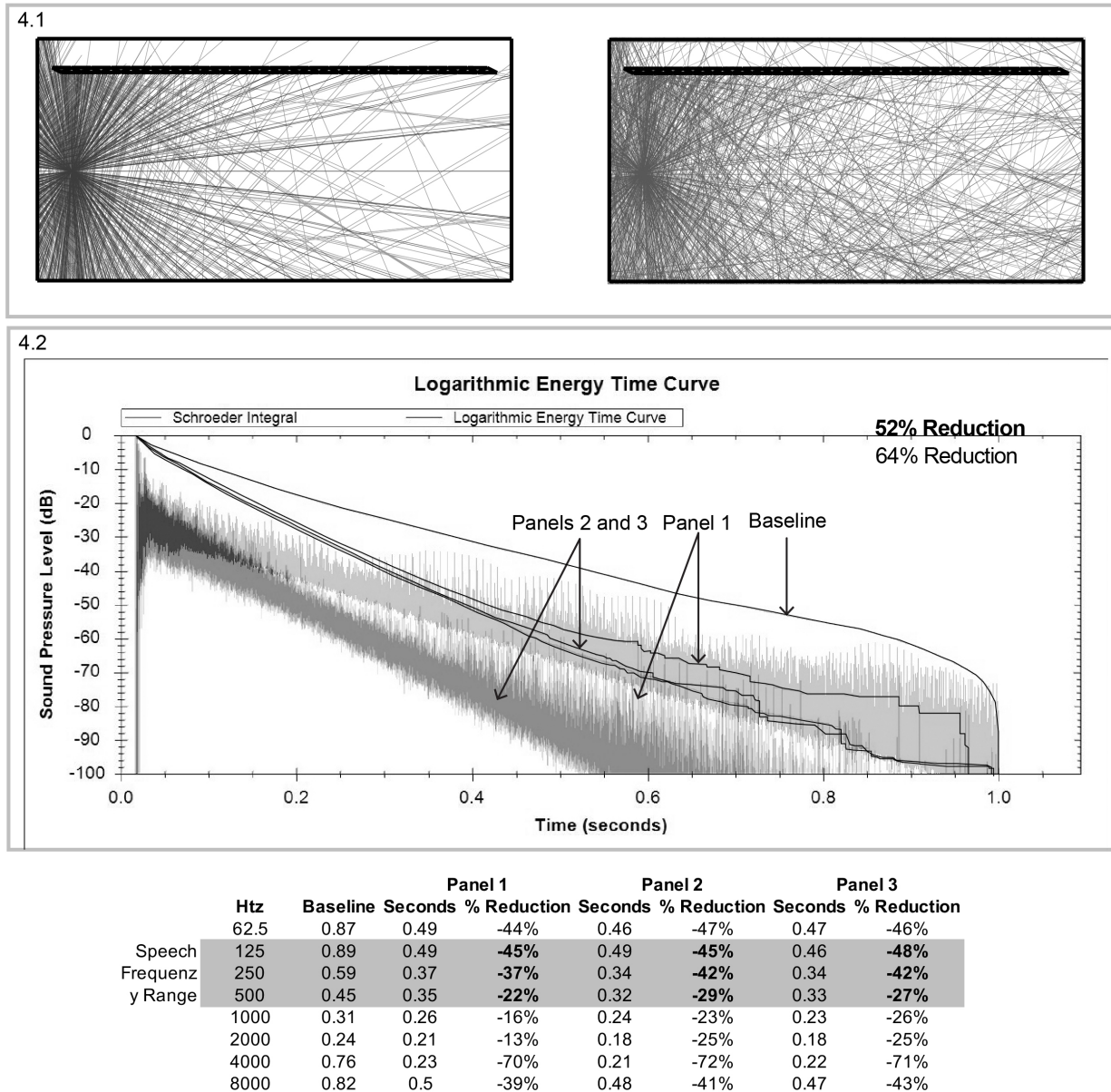

Figure 4: Simulation results. Source: Authors

CONCLUSION

The goal of the exploratory work presented in this paper was to explore alternative materials to improve the acoustic conditions of classrooms in primary public schools in developing contexts by making low-cost insulation panels made of waste corrugate cardboard sheets and conventional glue. The study tested the fabrication of three types of cardboard panels designed with origami patterns and simulated the acoustic performance using the Pachyderm software for Rhinoceros. All designs decreased reverberation time considerably for different wavelengths suggesting the panels could work. Although the differences between the three versions do not appear to be significant, ranking the panels with a denser pattern the most efficient (Panel 2 and 3), the findings suggest the potential positive impact of the system for classrooms at a meager cost. Fabrication workflow was also considered to assess panels design, and in this case, the panels with the less dense pattern were the easiest to fabricate (Panels 1 and 2).

In order to improve the acoustic performance even more, future research can try out other strategies to improve the performance of the panels, such as layering more sheets of cardboard, perforating them, combining layers of cardboard with other recycled material to increase sound absorption (e.g., shredded paper, denim, toweling fabric, and natural fibers). Although these additions might increase fabrication complexity and cost, they could make panels more efficient. One limitation of the work is that we only focused on the Reverberation time. Future research can simulate or test the thermal efficiency of these cardboard origami panels, which is also critical in these types of buildings located in hot and humid climates.

Finally, we are looking to extend the use of these prototype panels for housing in developing contexts with poor building qualities, high reverberation time, and low thermal performance. In this way, we hope to increase buildings resiliency and take advantage of urban solid waste like corrugated cardboard that is currently underutilized.

REFERENCES

- Asdrubali, F., A. L. Pisello, F. D'Alessandro, F. Bianchi, M. Cornicchia, and C. Fabiani. 2015. "Innovative Cardboard-Based Panels with Recycled Materials from the Packaging Industry: Thermal and Acoustic Performance Analysis." *Energy Procedia* 78: 321–26. <https://doi.org/10.1016/j.egypro.2015.11.652>.
- Butko, Daniel. 2021. "A Sound Approach to Concrete: Transforming Concrete Through Shape and Porosity for Acoustical Reflection, Diffusion, and Absorption." *Technology|Architecture + Design* 5 (1): 46–58. <https://doi.org/10.1080/24751448.2021.1863673>.
- Gattas, J. M., and Z. You. 2016. "Design and Digital Fabrication of Folded Sandwich Structures." *Automation in Construction* 63: 79–87. <https://doi.org/10.1016/j.autcon.2015.12.002>.
- Gönenç Sorguç, Arzu, Ichiro Hagiwara, and Semra Arslan Selçuk. 2009. "Origamics In Architecture: A Medium Of Inquiry Or Design In Architecture." *METU Journal of the Faculty of Architecture* 26 (2): 235–47. <https://doi.org/10.4305/METU.JFA.2009.2.12>.
- Kang, Chun-Won, Mina K. Kim, and Eun-Suk Jang. 2021. "An Experimental Study on the Performance of Corrugated Cardboard as a Sustainable Sound-Absorbing and Insulating Material." *Sustainability* 13 (10): 5546. <https://doi.org/10.3390/su13105546>.
- Kang, Chun Won, and Yung Bum Seo. 2018. "Sound Absorption and Sound Transmission Loss of Perforated Corrugated Board." *Palpu Chonggi Gisu/Journal of Korea Technical Association of the Pulp and Paper Industry* 50 (4): 32–39. <https://doi.org/10.7584/JKTAPPI.2018.08.50.4.32>.
- Latka, Jerzy F. 2017. "Paper in Architecture: Research by Design, Engineering, and Prototyping." Delft University of Technology.
- Murillo, F Javier, and Marcela Román. 2011. "School Infrastructure and Resources Do Matter: Analysis of the Incidence of School Resources on the Performance of Latin American Students." *School Effectiveness and School Improvement* 22 (1): 29–50. <https://doi.org/10.1080/09243453.2010.543538>.
- Schiavoni, S., F. D'Alessandro, F. Bianchi, and F. Asdrubali. 2016. "Insulation Materials for the Building Sector: A Review and Comparative Analysis." *Renewable and Sustainable Energy Reviews* 62: 988–1011. <https://doi.org/10.1016/j.rser.2016.05.045>.
- Secchi, Simone, Francesco Asdrubali, Gianfranco Cellai, Elisa Nannipieri, Antonella Rotili, and Irene Vannucchi. 2016. "Experimental and Environmental Analysis of New Sound-Absorbing and Insulating Elements in Recycled Cardboard." *Journal of Building Engineering* 5 (March): 1–12. <https://doi.org/10.1016/j.jobe.2015.10.005>.
- Takeanada, Tsukasa, and Aya Okabe. 2013. "A Computational Method for Integrating Parametric Origami Design and Acoustic Engineering." In *Computation and Performance – Proceedings of the 31st ECAADe Conference*, edited by Rudi Stouffs and Sevil Sariyildiz, 2:289–95. Delft: TU Delft. http://papers.cumincad.org/cgi-bin/works/paper/ecaade2013_203.
- Turco, Massimiliano Lo, Ursula Zich, Arianna Astolfi, Louena Shtrepi, and Matteo Botto Paola. 2017. "From Digital Design to Physical Model: Origami Techniques Applied to Dynamic Paneling Shapes for Acoustic Performance Control." *ECAADe* 2: 77–86.
- Villalba, Mauricio. 2021. "Contribuciones a La Cultura Del Diseño Paramétrico y La Fabricación Digital En Paraguay Con Énfasis En Un Ejercicio de Diseño y Simulación de Cerramientos Superiores. Caso: Colegio Nacional Los Primeros Colonos Del Chaco." Universidad Nacional de Asuncion.
- Yanes-Pagans, Monica, Juan Bedoya, and Dalila Zarza. 2018. "Paraguay. Invertir En Capital Humano.: Una Revision Del Gasto Publico y de La Gestion En Los Sectores Sociales." <http://documents1.worldbank.org/curated/en/145651542655422647/pdf/132203-replacement-Chapter-Education-final1.pdf>.

Design for Change - Climate Centered Pedagogy in the Architecture Studio

Gabriel Kaprielian¹, Alex Hirsig²

¹Temple University, Philadelphia, PA

²California Polytechnic State University, San Luis Obispo, CA

ABSTRACT: Climate change is truly the existential threat of our time. With buildings generating nearly 40% of annual global CO₂ emissions, architects have an ethical and professional responsibility to consider the implications of their design on the environment, while architecture students need to be educated in effective adaptation and mitigation strategies. Organizations such as Architecture 2030 offer important framing of this topic, while also providing educational tools. However, there is still a dearth of information about how pedagogy in the architecture classroom can be developed to address the climate crisis. This paper describes how climate change has been foreground in the architecture studio at two collaborating universities. Each studio offers an important case study in developing climate smart architectural pedagogy to train the next generation of practitioners. While there were differences in scope of work and site location, shared investigative methods engaged with a multi-scalar perspective, expanding the role of architecture beyond the boundary of a building footprint to explore an interconnected network of the urban fabric and ecological systems. A mutual premise of the studios was to reframe climate change problems confronting our cities instead as opportunities for design innovation. This approach challenges students as future architects to rethink the current toolbox of the discipline and develop new methods of inquiry, analysis, and design of the built environment. Research outcomes discuss how pedagogical approaches in the studio led students to develop innovative methods of climate mitigation through research and application of sustainable building materials and construction methods reducing embodied carbon, net zero energy and closed-loop systems improving efficiency in building operations, in addition to climate adaptation addressing sea-level rise, urban heat island, and migration. The conclusion reflects on lessons learned from the studios to better train future architects to consider climate change as a primary component of their design.

KEYWORDS: Climate Change, Resilience, Pedagogy, Collaborative, Interdisciplinary

INTRODUCTION

In the most recent report by the Intergovernmental Panel on Climate Change (IPCC), scientists paint a dire portrait of the planet, where climate change is intensifying and global warming is increasing more rapidly than previously predicted (IPCC, 2021). This means that mitigation efforts to reduce greenhouse gas emissions have not been substantial enough, and adaptation strategies will need to be increasingly employed. With sustained reduction in emission of greenhouse gases, it could still take 20-30 years for global temperatures to stabilize and sea level rise will be irreversible over hundreds to thousands of years (IPCC, 2021).

Now, more than ever, there is a pressing need for sustainable and resilient solutions in design and planning of the building environment that directly address the mounting issues of climate change facing our cities. The Fourth U.S. National Climate Assessment report states that while many impacts of climate change are unavoidable, much is still largely determined by our collective actions (Hayhoe, 2018). With embodied carbon in building materials and construction contributing 10% of global CO₂ emissions and building operations generating 28%, architects have a professional and moral responsibility to do better to mitigate climate change (United Nations, 2020). Strategies to make buildings net-zero energy and zero-carbon will be essential for global decarbonization and according to the Global Alliance for Building and Construction, this “should become the primary form of building construction across all economies to achieve net zero emissions by 2050” (United Nations, 2020). Furthermore, architects will need to consider new and innovative strategies to adapt to a changing climate that respond to more intense rainfall and flooding, continued sea level rise, extended droughts, and amplified heat waves.

It is clear that climate change mitigation and adaptation should be an essential part of architecture in professional practice and in the education of future architects. In turn, curriculum in architecture schools must be able to train students to understand the challenges and impart solutions for addressing climate change in the built environment. The American Institute of Architects has developed a Climate Action plan that declares an “urgent climate imperative for carbon reduction,” pressing architectural practice to “achieve a zero carbon, equitable, resilient, and healthy built environment” (AIA, 2020). In their climate action goals they call for: (1) “*Mitigating the sources*” to “achieve zero CO₂

emissions in the building sector by 2040;" (2) "*Adapting to the impacts*" to "design buildings and communities that can anticipate and adapt;" (3) "*Catalyzing architects to act*" through leadership in "partnership with our global community" (AIA, 2020). How do these goals take action, rather than just serving as appealing aspirations and formal platitudes? How do we train the next generation of architects to have the knowledge and skillsets to address the complex and wicked problems related to climate change?

1.0 CLIMATE CHANGE AS ARCHITECTURAL PEDAGOGY

1.1 Architecture education leading the profession

Architecture envisions speculative futures and makes tangible spatial imaginaries into physical form. By its very nature, architecture is an optimistic pursuit that believes in creating a better world. The pressing challenges posed by climate change, present opportunities for design innovation. Architecture students today, may very well be the leaders tomorrow in developing and applying climate change mitigation and adaptation efforts in professional practice. This, of course, will very much depend on how students are taught and if there is a focus on these topics in the classroom and throughout the curriculum. Much like how the introduction and application of digital tool for drafting, modeling, and rendering radically changed architectural education and practice in the early 2000's, there can be a new shift related to a focus on climate change. If addressing the climate crisis is a major part of architectural pedagogy, recent graduates may take on important roles and responsibilities early on in their careers, similar to how graduates with strong digital skills have influenced firm dynamics.

1.2. Program criteria goals for climate curriculum

There is often no formal program criteria in architecture schools for educational goals related to climate change. The recent NAAB guidelines may present an opportunity for schools to further define how issues of environmental sustainability are integrated into the Program Criteria. Schools are asked to "demonstrate how its curriculum, structure, and other experiences" address the (8) Program Criteria (NAAB, 2020). The NAAB criteria include "PC.3 *Ecological Knowledge and Responsibility*," which is expected to show how architecture students are learning to "mitigate climate change responsibly by leveraging ecological, advanced building performance, adaptation, and resilience principles in their work and advocacy activities" (NAAB, 2020). In faculty meetings at Temple University, it has become clear that PC.3 could be incorporated into nearly every class. However, questions remain about what materials should be taught, how can they be incorporated, and what resources are out there to guide this?

1.3. Platforms for academic resources

Organizations such as Architecture 2030 offer a platform to share knowledge and direct architectural development of "sustainable, resilient, equitable, and zero-carbon buildings, communities, and cities" (Architecture 2030). Their contributions include the 2030 Palette, an online resource for climate change responsive strategies from the building to regional scale (Architecture 2030). Architects Climate Action Network (ACAN) offers online resources for architecture instructors with their Education Toolkit and Educators Workshops. Resilience by Design University (RBD_U), an offshoot of the Rebuild by Design Competition brings together students, practitioners, and community in workshops and symposium on issues of resilience, in addition with current efforts to coordinate and share climate change related curriculum in architecture schools. US Architect's Declare has a similar committee underway that seeks to create climate change related educational tools and resources for both practitioners and students of architecture.

1.4. Intercollegiate studio coordination

It is within this context that Professor Gabriel Kaprielian of Temple University and Professor Alex Hirsig of Cal Poly developed climate change pedagogy for their architecture studios. However, it was a matter of chance invitation to serve as a mid-review guest critic that the content of each studio was shared. It just so happened that both studios at were developing projects for a Climate Change Institute in Philadelphia and Center for Climate Change in New York. This shed light on the lack of present coordination and collaboration between architecture schools to address climate change. Seeing an opportunity to share resources and amplify the educational experience of the students, coordination of the studios took place from mid-semester onward. This included combining the students on opposite sides of the country for shared group presentations using *Miro* virtual whiteboard and *Zoom*, sitting in on each other's reviews, and sharing of syllabus and course material. The result of the collaboration was beneficial to both instructors and students alike. It resulted in planned further alignment of climate change related studios and the writing of this paper with the intended goal to bring climate change related architectural pedagogy into the foreground as a vital element of contemporary architecture education. By sharing examples of each studio methodology, outcomes, and reflection the intended purpose is to serve as precedent and establish discourse on how best to incorporate these pressing challenges in the architectural classroom.

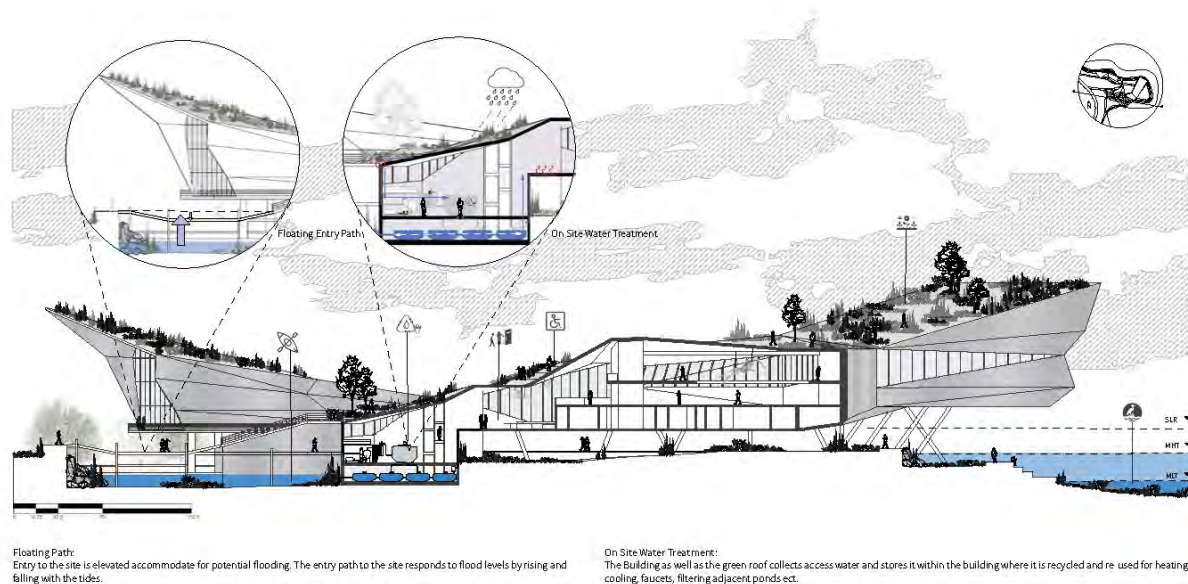

Figure 1: Climate Change Institute Section Drawing. Source: (Isaiah Graham – Temple University, 2021)

2.0 STUDIO PROJECT: CLIMATE CHANGE INSTITUTE, PHILADELPHIA

2.1. Studio Introduction

The 4th year Capstone Architecture Studio project at Temple University was titled, “Climate Change Institute - Adaptation in the Anthropocene: Resilience, Ecology, and Poetics.” The goal of the studio was to explore the role architects can have in adaptation and mitigation efforts related to a changing climate. The semester-long studio project was located on Philadelphia’s Delaware River waterfront. The course was structured into three phases: (1) *Site Analysis + Research*, focusing on precedents from Rebuild by Design and Resilience by Design competitions and interdisciplinary research, such as the Urban Waterfront Adaptation Strategies handbook developed by NYC Planning and other international studies; (2) *Neighborhood Master Planning*, exploring a multi-scalar urban design and planning strategy for the year 2121 to accommodate sea-level rise and increasingly severe storm events, resilient infrastructure, and the reintroduction of tidal wetlands; (3) *Architectural Design for a Climate Change Institute* sited on the water’s edge at Pier 55 that is adaptive and resilient to continually changing site conditions.

2.2. Instructional Methodology

Through extensive fieldwork and research of the past, present, and future transformations, the site became a significant factor in the studio project. A major premise of the studio brief was considering how to design architecture that is adaptable to ever changing site conditions within the contested landscape of a tidal waterfront. In “Why Site Matters,” Carol Burns and Andrea Kahn describe site thinking as “continually oscillating between material and conceptual, abstract and physical, discursive and experiential, and general and specific points of view” (Burns and Kahn, 2005). This varied and contradictory interpretation reconfigures site as a dynamic process and places it in a broader architectural discourse. Like many urban waterfronts in tidal cities, the post-industrial area in the studio site is no longer used as an active port and includes mostly underutilized and vacant land. Much of the site was built with landfill on the historic tidal wetlands, also making it highly prone to inundation from sea level rise and increasingly severe storm events. These challenges presented students with an opportunity to redefine the waterfront in Philadelphia, developing a resilient urban form that blurs the edge between water and land. The students were asked to develop a Master Plan where they choose what development to protect, where to have a managed retreat, and how to accommodate of sea level rise, while reintroducing tidal wetland ecologies that coexist with resilient new forms of built environment.

The incorporation of multi-scalar design was a fundamental part of the studio project. Through designing a Masterplan for the neighborhood, architecture students were able to contextualize the subsequent building design of the Climate Change Institute within a larger system of built and natural environments. Expanding beyond the building footprint, students explored the interconnected networks of social, infrastructural, and ecological systems that later influenced decisions at the architectural scale. A *21st century toolkit* of adaptation and mitigation strategies was developed by each student team from case study research to be applied in phased planning and architectural design from 2021 to 2121.



Figure 2: Climate Change Institute Perspective Renderings. Source: (Tanzina Islam – Temple University, 2021)

Scenario planning and the introduction of *chance events cards* established design thinking to include the multiplicity of unknown and external factors that could contribute to success or failure of the strategies. Students were asked to further interrogate their plans by creating *stakeholders profiles* to develop design empathy to understand who they might be designing for and to consider multiple personal perspectives and motivations.

In addition to collaborating Cal Poly architecture studio, there was planned coordination with a graduate landscape architecture studio at Temple University focused on the same site and scope to incorporate a cross-disciplinary perspective. Since the studios met on different days, a co-taught interdisciplinary team studio was not possible. However, each instructor coordinated meetings between the landscape and architecture students to consult each other's projects as the "disciplinary expert." By foregrounding the issue of climate change, students from both studios were able to consider how integration of site and building design can create robust adaptation and mitigation efforts.

Students utilized resources from the Architecture 2030 Palette to explore strategies for the "design of zero-carbon, adaptable and resilient built environments" from the scale of region and city, district and site, building and material (Architecture 2030). These examples offer a good starting point for students to consider incorporating climate change adaptation and mitigation strategies at different scales of design. Furthermore, the AIA COTE student competition focused on solutions to climate change as a framework that the studio was built upon. This competition offered criteria with which to judge the meaningful impacts to imagine "healthy, sustainable, and equitable future in the categories of: Design for Integration, Equitable Communities, Ecosystems, Water, Economy, Energy, Well-Being, Resources, Change, and Discovery" (Architecture 2030). The studio guide further illustrated supplemental resources for instruction to consider the site, project, and analysis.

2.3. Student Projects

The students responded to the complex challenge of the studio with brilliance and ingenuity. At the urban scale, student projects envisioned a changing waterfront that became a mosaic of spongy tidal wetlands, boardwalks, parks, and programmed spaces that embraced the wet and constantly changing landscape including consideration of a more-than-human-world. Masterplans sought to stitch together the current residential neighborhood with future resilient development built into tidal wetlands, connected through blue/green infrastructure and multi-modal transportation in a post-combustion engine world. Architectural designs of the Climate Change Institute were integrated into new adaptive urban fabric such as Student Isaiah Graham's project "Restore the Store," [fig. 1] which allows for the managed retreat of the shoreline as sea levels rise, while embracing the reintroduction of the tidal wetlands with a network of pathways. "Inhabiting Nature," [fig. 2] by Tanzina Islam utilized a raised foundation along with pier and submerged architecture, while cohabitating with rising water and tidal ecologies. In the Urban Design proposal by Joe LaPorta and Marcos Diaz-Sanchez [fig. 3], they transform the city grid into a new system of buildings raised on piers along a ring road and tidal wetlands, while utilizing existing infrastructure of the highway as a tidal barrier and lock to protect dense new raised development connected both to the historic city fabric and water transportation along the Delaware River.

2.4. Studio Reflections

The final projects in the studio were consistently strong at the application of design responses to address climate change. It was evident that the collaboration with Cal Poly and the graduate Landscape Architecture studio at Temple University made a considerable impact through sharing of ideas and motivation in pushing students to explore new modes of architectural design. However, it was also a challenging semester for all students, asking them to consider so many factors in their project from design at both urban and architectural scales, interdisciplinary design integrating building and site, and design that responded to climate change adaptation and mitigation. Student projects were far more developed in adaptation rather than mitigation. This was perhaps due to having already developed an adaptation framework in the masterplan that was then applied at the architectural scale to respond to sea-level rise. While some student projects applied sustainable strategies in their building design, it was not a primary design driver as it was with the comprehensive studio at Cal Poly. If students would have had more exposure to courses in the curriculum that foreground climate change adaptation and mitigation, a better integration of the two may have been more successful.



Figure 3: Climate Change Institute Site Design Isometric Drawing. Source: (Joe LaPorta + Marcos Diaz-Sanchez – Temple University, 2021)

3.0 STUDIO PROJECT: CENTER FOR CLIMATE CHANGE, NEW YORK +

3.1. Studio Introduction

For the past four years, a 3rd year architectural design studio taught by Professor Alex Hirsig at Cal Poly has designed a Center for Climate Change, leveraging the museum typology to explore the social and performative challenges surrounding architecture and climate change. For many, museums remain trusted sources of knowledge, a civic space akin to the library. Science and art museums are particularly adept weaving a tapestry of complex social, cultural, and technological phenomena into a tangible place for provocation. The studio brief asks how civic museums can curate the discussion on climate change and become a catalyst for change, and what role the architect can have in shaping the culture of climate change through this place-making. A deviation in the project brief has been a unique coastal context, which offers an opportunity for interpretations in its influence. The first project site was a small coastal town of Morro Bay, CA, the second in the urban SOMA neighborhood of San Francisco similar in climate. Most recently students have researched and agreed upon a NYC site evaluated by its perceived potential.

3.2. Instructional Methodology

Cal Poly operates on a quarter schedule, allowing students ten weeks to generate a conceptual design proposal. This studio began with a two-week warm-up project asking students to generate an expressive sculptural response to a topic of their interest that is generated by climate change events. The objective of this site-less assignment is to tap into a student's self-interest and personal history and reveal a studio fabric of individual perceptions about climate change through a shared creative medium. The students spend the following eight weeks developing a Center for Climate Change, with two weeks in site, typology, and climate change discourse, three weeks generating conceptual leads, and five weeks developing the Schematic Design.

Students arrive in the studio with different attitudes toward climate change issues. In a contextual learning approach the studio aims to recognize the third space, where the students bring their own experiences and imagination to bear in the interpretation of the artwork (Stevenson, 2005). The studio environment is an opportunity to leverage their individual histories and find places where collaborative discussion can reveal alternative concerns and perceptions. In *The Third Space Why Learning Matters* a student explains,

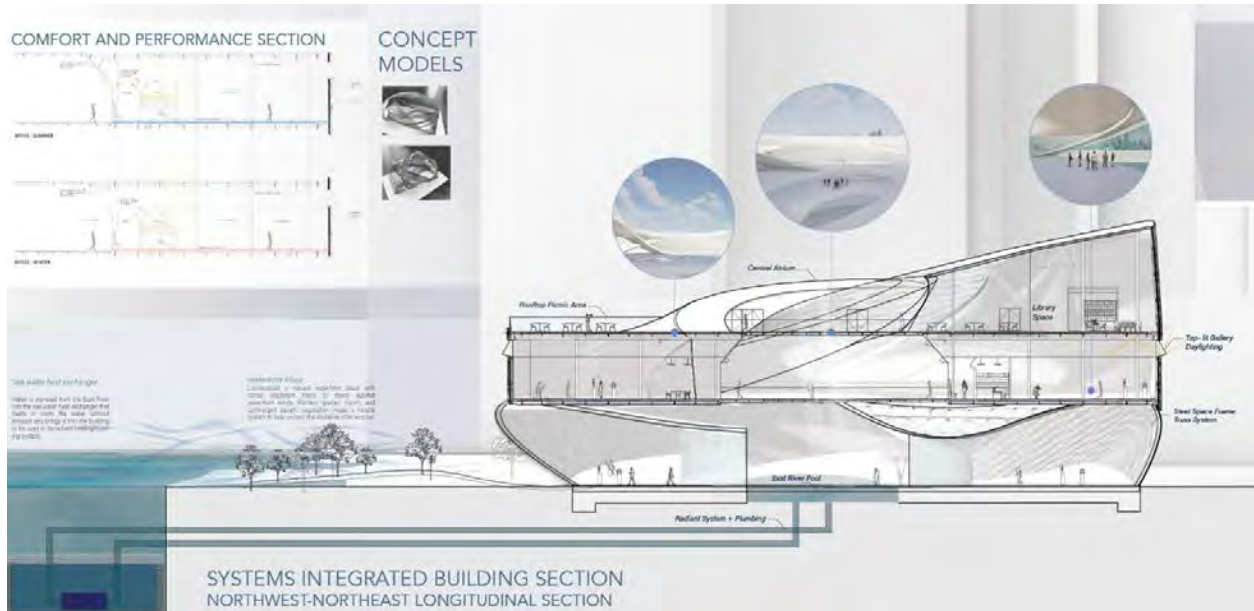

Figure 4: Center for Climate Change Building and Site Section Drawing. Source: (Cal Poly, 2021)

“If you don’t see things from different points of view it will be boring, just that’s right and that’s wrong. With art you can go around the subject. You can curve, make shapes; find new ways to enter it” (Stevenson, 2005).

The studio objective is to continually find new ways to “enter” the problems creating climate change. Designing a “Center for Climate Change” places a tremendous responsibility on the architectural solution to be a forward-thinking model for sustainable design, and the project site has had a strong influence on the potency of the student’s response. The studio takes a whole systems approach to the site, which asks students to consider their site not within a property line, but where water, energy, and probable materials are sourced. The AIA Framework for Design Excellence is unpacked to discuss how the project might serve two communities, local and global.

Given the museum typology, the studio discussions are tailored toward impactful building performance solutions and visitor provocation more than adaptation. Allowing the students to start design by story and aesthetics invites performance problems to emerge but also signals an imagination safe-zone in the project. An important pedagogic interference occurs in dedicating time to discussing how initial gestural interests for the project might affect social and performance values related to climate change. These challenges can prompt brainstorming of imaginative solutions for climate change mitigation where precedents offer only partial views. A pedagogical goal is to help students assign a currency to their ideas which can better inform decision making.

Digital models have come to dominate the design process, offering a gateway for integrated building performance simulation. We use simulation tools in our studio to estimate EUI and daylight distribution at first formal concept, however the effective application of the studies are limited by student’s concurrent first-time introduction to active building systems and course time constraints. Simulation software has been slow to adopt in professional practice due to intermittent use, workflow shifts, and interdisciplinary training (Hirsig, 2010). These challenges are overcome in practice through collaborative architecture and engineering teams, and a model adaptable to the college studio is of future interest to this studio.

3.3. Student Projects

Students are eager to adopt strategies to mitigate climate change. Given the studio prompt it is not surprising to see projects including technical features like photovoltaics and geothermal aimed at net zero energy, or rainwater retention for re-use. The students recognize reducing embodied carbon through declaration of the structural system and building envelope materials, but typically in absence of quantitative study. Student ideas which reach beyond the engineering applications and explore sensory influences are encouraged as promising examples of deeper thinking about climate change and our place between buildings and the natural environment. The following projects exemplify a synergy between performance and experience to provoke sensory awareness of environmental conditions and comfort among visitors. In a 2017 project the student accelerated the experience of sea level rise by locating a portion of the project entry in the tidal zone, providing previously unavailable “shoreline” to a bay fill bluff. In a 2018 project the piezoelectric hairs adopt an anthropomorphic presence. In a 2020 project [fig. 5] the student wrestles with the requirement for a civic institution to provide energy consuming conditioned space by programming mid-doors spaces. In a 2021 project [fig. 4] the turbid water of the East River mixes with harvested stormwater to reimagine the community-centered water play space that couples for building thermal exchange.

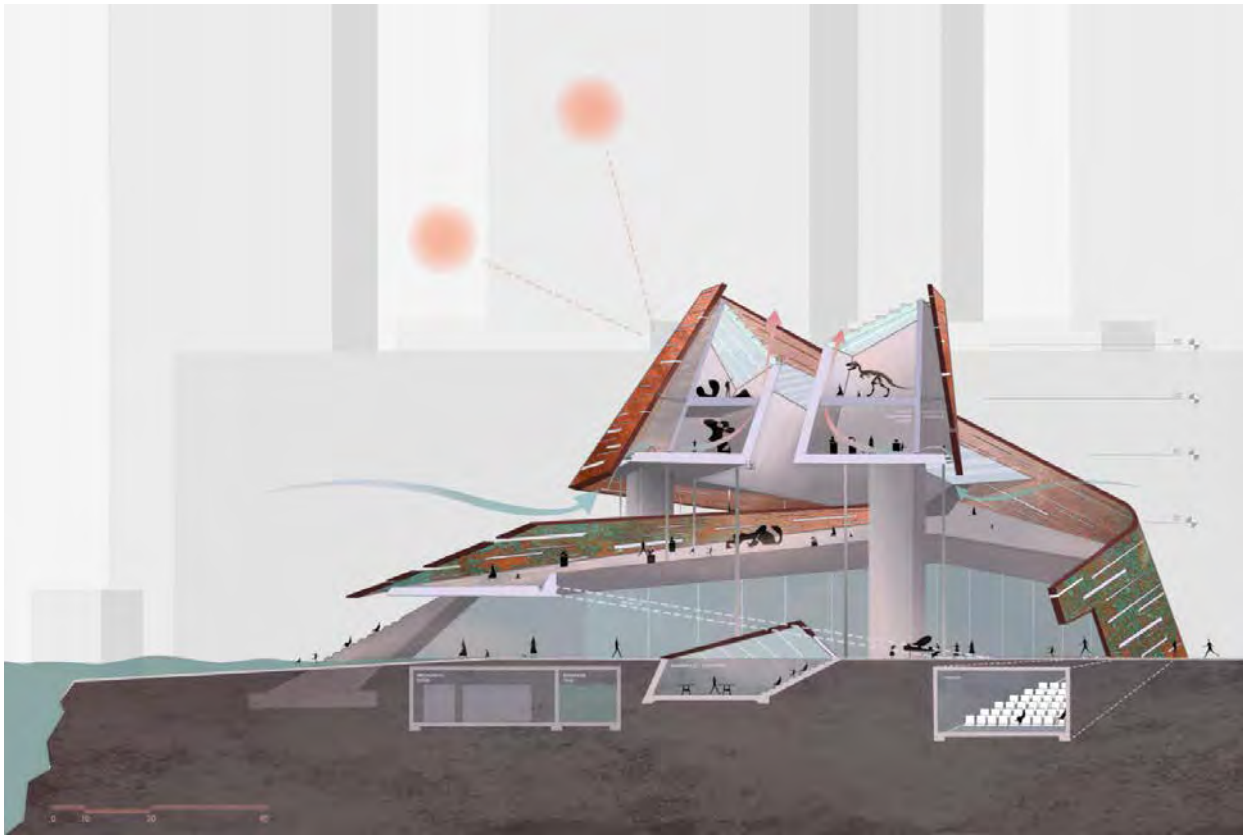

Figure 5: Center for Climate Change Building and Site Section Drawing. Source: (Cal Poly, 2020)

3.4. Studio Reflection

While student interest in mitigating climate change is personal, resolving climate change is a community concern. The college design studio environment provides the platform of community, reinforcing a collective interest and benefit. The intercollegiate studio discussions actively broaden the definition of community to the scale of climate change. Climate change conscious decisions may appear at different magnitudes for different individuals and recognizing and celebrating these moments is important encouragement. Drawing upon student’s personal experiences has proven successful to igniting interest in design for climate change, while allowing agency has produced the most memorable concepts.

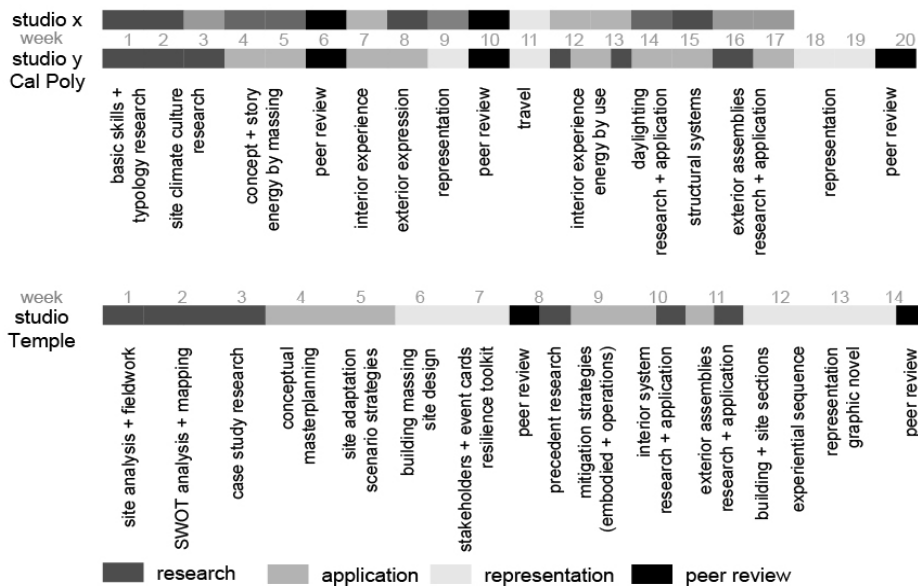

Figure 6: Studio Sequence Graph. Source: (Gabriel Kaprielian + Alex Hirsig, 2021)

CONCLUSION

The increasing urgency of the climate crisis is a call to architects to strive for further innovation and application of climate change mitigation and adaptation strategies. It is essential that curriculum foreground climate change in architectural pedagogy to prepare students to be the future leaders in the profession. The new NAAB Program Criteria requirements offer an opportunity for schools to define new sustainability and resilience focused curricular goals. While organizations such as Architecture 2030 and Architects Climate Action Network currently provide tools and resources for administrators and instructors. The climate change studios by Temple University and Cal Poly offer precedents for successful course structure and instructional methodology, while also offering insight on the benefits of leveraging intercollegiate studio coordination to share resources, amplify student engagement, and grow an academic community. To address the pressing challenges in the built environment, our best hope is for architecture schools to further develop platforms for collaboration, knowledge sharing, and interdisciplinary thinking that respond to the climate crisis.

REFERENCES

- AIA 2020. *Climate Action Plan*. New York: AIA.org (https://content.aia.org/sites/default/files/2020-07/AIA_Climate_Action_Plan.pdf)
- ACAN 2021. *Climate Action Resources for Schools of Architecture*. Architects Climate Action Network. (<https://www.architectscan.org/education-toolkit>)
- Architecture 2030 2021. *2030 Palette*. Santa Fe: Architecture 2030. (<https://architecture2030.org/education/>)
- Burkett, V.R. and Davidson, M.A. [Eds.] 2012. *Coastal Impacts, Adaptation and Vulnerability: A Technical Input to the 2013 National Climate Assessment*, Chicago, IL: Island Press, The National Oceanic and Atmospheric Administration
- Burns C. and Kahn A. 2005. "Why Site Matters" in *Site Matters: Design Concepts, Histories, and Strategies*, Burns, Carol J. and Andrea Kahn, eds. New York: Routledge.
- Hayhoe K. and Fahey D., et. al. 2018). *Volume III: Impacts, Risk, and Adaptation in the U.S.*" *Fourth U.S. National Climate Assessment*, U.S. global Change Research Program.
- IPCC 2021. *Summary for Policymakers. In: Climate Change 2021: The Physical Science Basis. Contribution of Working Group I to the Sixth Assessment Report of the Intergovernmental Panel on Climate Change* [Masson-Delmotte, V., P. Zhai, A. Pirani, S. L. Connors, C. Péan, S. Berger, N. Caud, Y. Chen, L. Goldfarb, M. I. Gomis, M. Huang, K. Leitzell, E. Lonnoy, J.B.R. Matthews, T. K. Maycock, T. Waterfield, O. Yelekçi, R. Yu and B. Zhou (eds.)]. Cambridge University Press. In Press.
- Hirsig, A. 2010. *Finding Synergy in Simulation, Modeling by Architects and Engineers in Conceptual Design*, SIMAUD.
- NAAB 2020. *Conditions for Accreditation 2020 Edition*. Virginia: National Architectural Accrediting Board. (<https://www.naab.org/wp-content/uploads/2020-NAAB-Conditions-for-Accreditation.pdf>)
- RBD U 2021. *Resilience by Design University*. New York: Rebuild by Design. (<http://www.rebuildbydesign.org/news-and-events/updates/resilience-by-design-university-rbd-u>)
- Stevenson L, Richard J., and Deasy C. 2005. *Third Space: When Learning Matters*, Arts Education Partnership
- United Nations Environmental Programme 2020. *2020 Global Status Report for Buildings and Construction: Towards a Zero-emission, Efficient and Resilient Buildings and Construction Sector*. United Nations Environmental Programme: Nairobi.

Reimagining Growth: Cross Analysis of Environmental and Social Data Between Shifting Populations

Nicole Hall¹, Milad Hosseini-Mozari²

¹School of the Art Institute of Chicago, Chicago, IL

²University of Utah, Salt Lake City, UT

ABSTRACT: In the last decade populations have been shifting across the United States, trends further impacted by environmental changes and a global pandemic. To further understand these shifts, this paper looks at statistical, environmental, and social data in two cities: Chicago, Illinois (declining population) and Salt Lake City, Utah (growing population). In Salt Lake City with the high desert terrain of a valley and an expanded grid, the extensive city layout has seen a consistent increase in population the past few decades. Coined as the "silicon slopes" for the influx of tech companies relocating to the area, being branded for its "smart sprawl" the lure of the amount of space, low cost of living, and the accessibility of the recreational outdoor. In Chicago with an ever-evolving urban economy relying largely on tourism, large corporate headquarters, and the higher education-medical facility industry, city planners have been focused on vertical growth and density with allocated leisure space since 1909. Long grappling with inequities and economic segregation, Chicago has struggled to build a global reputation on par with its cultural, economic, and geographic strengths. While each city has built its own dynamic urban landscape and evolved over time to accommodate an ever-changing landscape, climate change, and the ensuing environmental repercussions, both have seen the disparities of air quality, green space, and clean water deepen across communities. By comparing factors including air quality, noise levels, green space, health disparities, community services, cultural organizations, and socio-economic factors in a multi-layer statistical analysis, it is possible to understand commonalities and differences of each city as well as across its individual communities. If data can provide cause and effect insight on shared experiences across two wildly different urban cities, it is possible to develop essential resources towards predictive analysis and remediation efforts across urban cities.

KEYWORDS: Climate, technology, equity

INTRODUCTION

In the last decade, populations have been shifting across the United States, further impacted by the global Covid-19 pandemic beginning in 2020. To better understand these shifts, this paper looks at statistical and social data in two cities: Chicago, Illinois (which has a declining population) and Salt Lake City, Utah (which has a growing population). The United States exists in a moment of transitions where populations have resettled between urban and rural spaces and across regions. Much of the research on this topic focuses on response, looking at ways localities can adapt to new populations. In this research, we seek to understand the factors that influence these population shifts. Recognizing that no one factor has the power to move humans through physical space, we opted for a multi-layer spatial analysis based on layers of health, social, economic, environmental, and historical data. In this way, it is possible to more clearly understand connections between data points and patterns of migration.

In particular, this study looks at two very different cities as case studies in population growth and decline. Both cities share a carefully executed initial master plan, created on a largely blank slate. Salt Lake City's master plan was designed prior to settlement in 1847, while Chicago's was redesigned in 1909, after the Great Chicago Fire. Both plans were developed to meet the needs of specific populations and both have had to adapt drastically over the years as those populations evolved through human and environmental changes.

While each city has built its dynamic urban landscape that is adaptive, both have seen disparities deepen across communities in the recent pandemic. By comparing life expectancy, real estate costs, cultural organizations, leisure activities, and environmental factors in a multi-layer statistical analysis, it is possible to understand commonalities and differences of each city as well as across its individual communities. If data can provide insight on shared experiences across two wildly different urban cities, it is possible to develop essential resources towards predictive analysis and remediation efforts across urban cities.

1.0 HISTORY

1.1 Salt Lake City

In the past decade, the Salt Lake City metropolitan area population has grown at approximately 0.07% annually, while Chicago's metropolitan area has declined at approximately 0.02% annually. In this study, we compare factors both within each city and between them, identifying clusters of correlating data, commonalities of urban experience, and statistically significant differences to create a system of metrics to empirically understand and predict shifts in urban populations.

Heavily inspired by the Plat of Zion, Salt Lake City's layout accommodates a grid system similar to many other western United States cities planning of the 19th century. Devised initially by Joseph Smith in the June of 1835, the aspiration grid system organizes a city layout that accommodates belief system, community, and small-scale farming. This land interpretation situated in the valley has made for both positive and lesser than favorable growth conditions.

In its expansion, the tech and construction industry are continuously growing within the city and state as more companies, families, and individuals migrate for space and means of living. This can be partnered with the increased population, where since the 1990s, there has been a steady 16-24% change and increase. Coined as the "silicon slopes" for the influx of tech companies relocating to the expanding area, the "smart sprawl" lures those with a certain level of education seeking more living space, low cost of living, and accessibility of the recreational outdoors. However, this growth has not been uniform across demographics. With its already lacking diverse population, more middle-class professionals disproportionately fill its suburban southern edge.

Additionally, having recorded the "worst air in the world" in the past year, the accelerated growth of Salt Lake City doesn't seem to keep up with its surroundings or proximity. In other words, the city's industrial growth and terrain have a hard time being environmentally sustainable. Alongside a steady increase in temperature since the 1990s, the valley is becoming more inhabited and coupled with the dry heat seasoned with PM 2.5.

1.2 Chicago

In Chicago, with an ever-evolving urban economy relying mainly on tourism, large corporate headquarters, and the higher education-medical facility industry, city planners have been focused on vertical growth with allocated leisure space since Daniel Burnham's first post-fire city plan in 1909. Forever struggling with its reputation as the 'second city', Chicago is a resilient city. However, the inequities and economic segregation across many of its communities still reflect the early disparate neighborhoods from which it was built.

Chicago was presented with a unique opportunity to redesign its urban landscape due to the Great Fire of 1871 in which 1/3 of the city was ruined. While this tragedy left many homeless, the fire did not impact transportation or industrial structures, allowing the city the economic strength to rebuild. As Daniel Burnham embarked on his urban plan, we were guided by the City Beautiful Movement, a direct response to the realization that Chicago had become dirty, overcrowded, and polluted as it evolved around early industrialization. As American cities grappled with these challenges (in many cases resulting in mass migration out of urban areas in the early 20th century), Chicago took the opportunity to structure its new grid around a thriving vertical downtown, accessible green space, and the division of commercial/residential and industrial spaces. Unfortunately, this plan neglected to address poverty, immigration, and affordable housing. While typical of the era, this oversight set the stage for issues of segregation and health inequity, which the city continues to grapple with.

2.0 RESEARCH CONCEPTS

As a result of massive changes in the geography, composition, and world economic frameworks, globalization has impacted cities immensely. Traditional economic centers of manufacturing have moved abroad and to satellite hubs leaving behind vacant land and environmental concerns. Associated with the decline of business is the loss of jobs resulting in unemployment, poverty, and social issues within cities. While these problems have been created by the global market, finding solutions falls most directly on the political leaders of U.S. cities who must negotiate the impact and potential of economic globalization and urban redevelopment. At the same time, populations have become transient. Particularly with evolutions in remote work, and its rapid growth during the pandemic, many citizens are no longer tied to place. Such workers tend to be in higher-paying positions, resulting in a widening gap of economic opportunity and clustering.

Strategies for local economies include a focus on education and remote workforce development while tackling the physical structure of their spaces. In order to improve these areas, connections to new economies become essential, and cities must negotiate support to draw in new citizens and improve environmental conditions while managing the needs and expectations of the residential community at its core.

As cities begin to address the reterritorialization of urban space, the immense change since global supply stresses and export of labor is clearly evident. As a result, political and civic leaders have had to evolve their strategies around investments in a balance of new urban and residential needs. Common policy approaches have included luring individual business firms, building economic sectors, and improving urban amenities and green spaces.

Improving amenities is one of the most visually evident elements of urban redevelopment. Older industrial cities frequently possess distinctive physical features, including waterfronts, transportation, architecture, and economic centers such as metropolitan cores and cultural districts. Progressive political leaders have focused on leveraging these assets to capitalize on their economic potential. This push for market-based urban development reflects a “growing awareness of the nexus between city revitalization and competitive, sustainable metropolitan growth” (Vey, 2007). These features identify a distinct culture and community, which articulated well can inspire a resurgence of new residents with positive environmental impact.

Another important theme is the importance of understanding the dynamic role of physical space. Centered around the idea of defensible spaces and the identification that the physical environment affects social behaviors and interactions (Coley, Sullivan, & Kuo, 1997). When thinking about physical space it also becomes important to think outside of the common conversation on architecture and the built environment to also consider the natural elements and common routes through communities. Recognizing the connection between physical space and social interactions is an important element that echoes throughout the literature and is essential to consider in any evaluation of urban social dynamics.

Building economic sectors have changed drastically through the shift of resources and labor. Where economies used to be extremely place-based, technology and infrastructure have enabled businesses to operate decentralized. Economic sectors now place a higher value on the bottom line than geographic connection to their customer base. Where once businesses chose to build economies based on physical contact to customers, services, and connection to trade, today, those decisions are directed by financial incentives that travel within milliseconds across continents.

As cities experience post-industrial population shifts, they also lose the market activity to support essential services. It is in this context that incentivizing business becomes a core strategy. While this has long been part of urban redevelopment strategies, their use has become increasingly significant in the modern era, with poor cities providing some of the most generous packages out of perceived necessity.

While the construction of economic sectors around luring individual firms with incentives is seemingly effective, this type of policy largely privatizes urban redevelopment with little restrictions on the parameters of these deals, often leading to corruption and a devastating impact on investment in necessary urban resources. This creates a structure where cities must now compete for businesses to support their economies, and the competition is fierce, particularly when citizens can now choose locations by factors other than place-based employment. This has led to a necessity to balance finances more carefully and to stretch more limited resources. Doing this to continue to support the social sustainability of a city is an immense challenge. In this way, it is important to look at the greater economic sector and promote contributions of non-subsidized urban redevelopment strategies as well.

With all the varying approaches to urban redevelopment, the most significant impact of globalization has been the change in the relationship between political/civic leaders and businesses. As business is no longer tethered to place, cities must seek ways to create value and community as a driver of urban development. This presents a series of complicated and multi-disciplinary discussions, which are all vital to the conversation. Saskia Sassen (Sassen, 2006) writes, “We need to enter the diverse worlds of work and social contexts present in urban space, and we need to understand whether and how they are connected to the global functions that are partly structured in these cities”.

Recognizing that globalization has structured these unique relationships helps analyze urban redevelopment strategies with an understanding of the impact of inequality, immigration, and politics of culture post-pandemic.

3.0 RESEARCH METHODOLOGIES

3.1 Study Methodologies

In this study, we utilize a combination of analysis methodologies, including GIS and comparative data analysis. With this information, we seek to build a narrative correlation study to better understand two cities experiencing contrary population shifts over the same ten year period.

A Geographic Information System (GIS) is a program that allows for the management, creation, and analysis of complex data in a spatial way. Typically used in urban planning and statistics for urban spatial analysis, the system is rooted deeply in social geography in its ability to understand human patterns, relationships, and movement. Unlike a chart based or direct statistical analysis, GIS allows for the identification of patterns in a visual way, often allowing for quick and intuitive assessment of data.

Comparative data analysis allows for the collection of data sets from the General Social Survey (GSS) to understand topical trends across spaces. The GSS is a nationally representative survey of adults in the United States on an array of contemporary topics. Collected by NORC at the University of Chicago since 1972, the survey seeks to monitor and explain trends in the attitudes and behaviors of contemporary American Society. In this study, the GSS provides insight into Salt Lake City and Chicago and the sociological positioning of its residents over the same span of the population, greenspace, and social service evolutions in our GIS analysis.

3.2 Process of Analysis

3.2.1 City Selection

As researchers working in Chicago and Salt Lake City respectively, the conceptualizing of this project began with conversations about the population shifts we were each experiencing. While we recognized these spaces are drastically different in many facets, our intimate knowledge of each allowed us to dig more deeply into the cultural factors and nuanced neighborhood characteristics. It is also our hope to expand this research to look at additional cities, using the impactful factors identified in this study. In this way, embracing the challenges of comparing asimilar cities allowed for the creation of a framework for statistically viable comparison.

3.2.2 Side-By-Side GIS Analysis of Population Change

Population data for this study was collected from the United States Census data for 2010 and 2020. Recognizing that census boundaries change slightly between collection years, calculations were made using areal interpolation, a reaggregation of polygon attribute data. By estimating the proportion of each census tract (in terms of both area and population) that overlaps the neighborhood polygon, the sum of these fractional populations gives us a reasonably accurate estimate of the population of the neighborhood.

We began our analysis with a comparison of US Census data to look at the overall change in population in the counties containing Salt Lake City and Chicago in a side-by-side format. In our first analysis, we reviewed the data numerically and immediately identified how different the scales immediately presented. For example, Salt Lake County experienced significantly higher growth areas, separated into quadrants with the most significant change on the southwestern edge of the county. Alternately, Cook County saw the majority of its growth anchored in Chicago’s downtown area, with a near band of flat change immediately surrounding. While this provided a compelling starting point for analysis individually, in the side-by-side analysis, the changes presented at such a significant scale that comparison was ineffective.

Shifting the scales from actual numeric counts to percentage change in population density allowed for a more effective side-by-side analysis. In this perspective it presented a clearer view of the contrast between the two cities. No area in Cook County presented the same growth as large swaths of Salt Lake County. While the banding around central Chicago became less defined, it remained and highlighted the differential between outer ring population decline and growth only in the most central areas of the city. Conversely, in Salt Lake County, the growth areas remained more clustered with the largest growth areas at double the percentage of any area in Cook County. With a goal of identifying factors that influence growth versus decline in population, these maps allowed us to outline areas for detailed analysis.

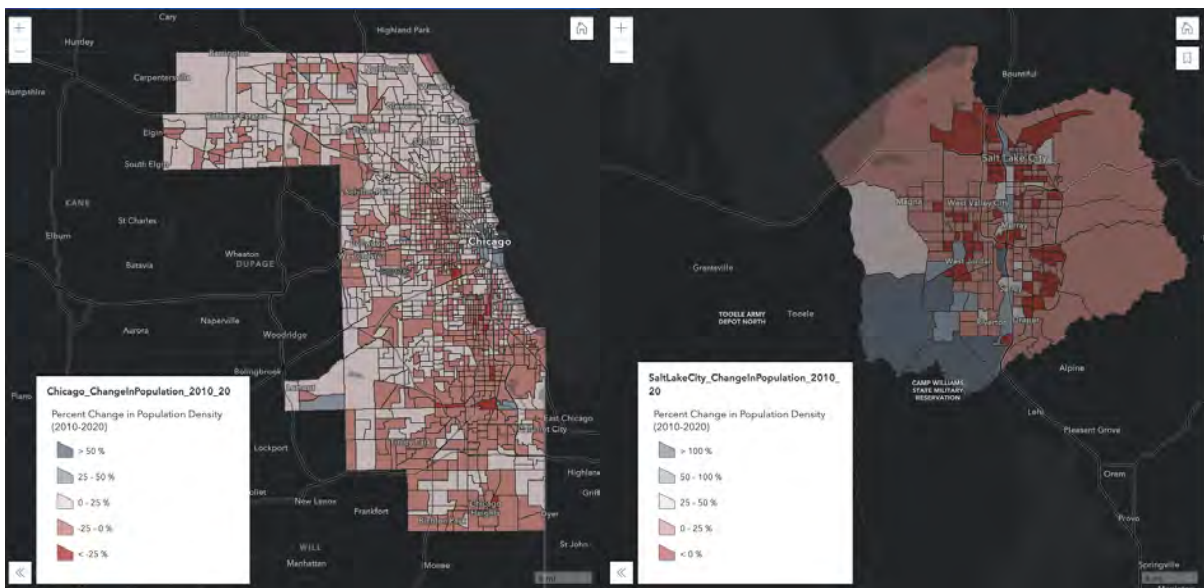

Figure 1: Side by side comparison of population change between 2010-2020. Cook County (left) and Salt Lake County (right). Source: Andrew Nelson, 2021

3.3 Impacting Factors

Understanding shifts in population is a nuanced calculation. Our collective research has looked at the impact of individual factors on urban populations, but here we seek to combine multiple impactful factors to understand the range of health, wellbeing, and place. The categories identified for analysis were health, government, community programming, population, leisure, history, planning, and green space, real estate, Covid-19 statistics, air and water quality, socio-economic measures, and sound. As we began collecting potential factors, it became clear that the list was potentially infinite, so we sought to identify sample factors from each category for an initial cross-analysis. This with the goal of a long-term project expanding this into a robust data collection and analysis project.

For this case study, we begin with the sample factors of public greenspace and libraries, looking at the proliferation and decline of these spaces as representative indicators of each County's commitment to environmental connection and public social services. Greenspace (defined for this study as parks, graveyards, golf courses, campsites, dog parks, picnic areas, and playgrounds) represents recreational, publicly accessible, managed, natural areas in both cities. Library locations indicate unique library branches. The library systems in both cities offer an array of public services in addition to book sharing. Both urban areas, recognizing the changing roles of libraries to essential public service centers (Greenhalgh and Worpole, 2019) have adapted programming to include disability support services, technology education, literacy projects, and community integrated programming. While these in no way encompass all environmental and social spaces, they serve in this study as representational data to begin correlation.

3.3.1 Greenspace

As we look at greenspaces both Salt Lake and Cook County have small greenspaces scattered across urban neighborhoods. While this indicates each area's commitment to greenspace compared to other more dense metropolitan cities, they do not indicate a discernible difference in neighborhood subgroups. Representation of this data provided varying nuance. At first looking at greenspace as centroids presented a similar spread. However, when reviewing the data in it's true polygons, the form of these spaces provided a more compelling comparison. A significant difference presents in areas of larger, planned greenspaces. In Chicago, we see long lines of connected greenspace, often spanning multiple neighborhoods. Most uniquely, greenspace follows the length of the lakeshore - an ongoing commitment to the original 1909 master plan's dedication of this area as publicly available to all. Otherwise, larger parks in both areas exist outside the city in areas of little public transportation connection.



Figure 2: Side by side interpretations of green spaces (polygon) of Cook County (left) and Salt Lake County (right). Source: Andrew Nelson, 2021

3.3.2 Libraries

For the distribution of libraries, both Cook and Salt Lake County have a fairly even distribution of libraries though Chicago's libraries exist in far greater density. While both cities see the density thin towards the outer edges of the county, in Salt Lake County this is so drastic that large areas, including those with the highest growing population, often have no libraries within their communities. Chicago has no areas with this large of an expanse between libraries. One interesting point of note is that the area of highest population growth in Chicago's (around the near north and sides of the downtown 'loop') is an area with public libraries on the outskirts but none within. This presents an interesting point of investigation. Research into requests for libraries in these areas yielded no results, indicating this was not a hypothesized limitation on city funding. Both areas have independently accommodated population growth through the

development of new residential construction and carefully plotted community amenities. The fact that libraries are notably missing from these spaces therefore seems to indicate a lack of market desire for these institutions and the public social services they offer.

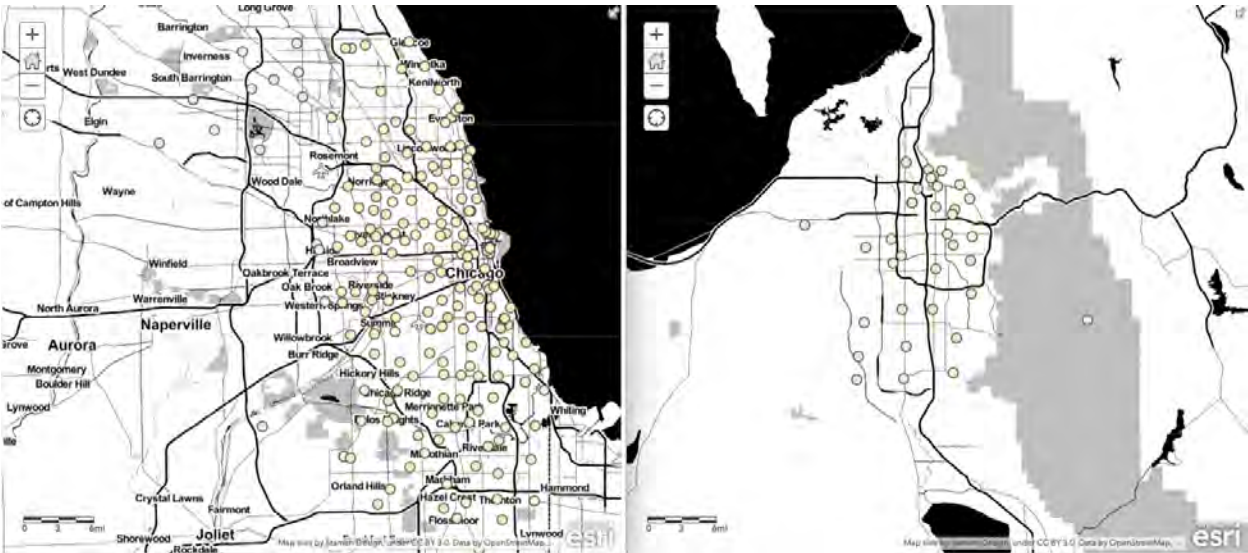

Figure 3: Side by side interpretations of libraries (unique locations) of Cook County (left) and Salt Lake County (right). Source: Andrew Nelson, 2021

3.3.3 Multi-Layer Analysis

By layering population change, greenspace (as our environmental indicator), and libraries (as social service centers), we were able to identify and examine individual areas with shared characteristics. While Chicago's development has occurred next to existing green space, Salt Lake has integrated additional greenspace into new development. Similarly, Salt Lake has added libraries in its growing communities while Chicago's growth areas - previously vacant post-industrial land - contain no new libraries.

This layered map analysis is ideal for this type of detailed investigation. Even in varying cities like ours, we can find points of comparison through the examination of this data in a relational way. This provides us with an array of next steps for continued analysis. As we seek to understand why nuanced differences exist, we can guide our research with compelling options. We could explore General Social Survey or American Community Survey human centric data to understand how development in these census tracts have responded and aligned with the expectations of its citizens. We could also look at environmental health data to understand the impact the planning decisions made in accommodating population shifts.

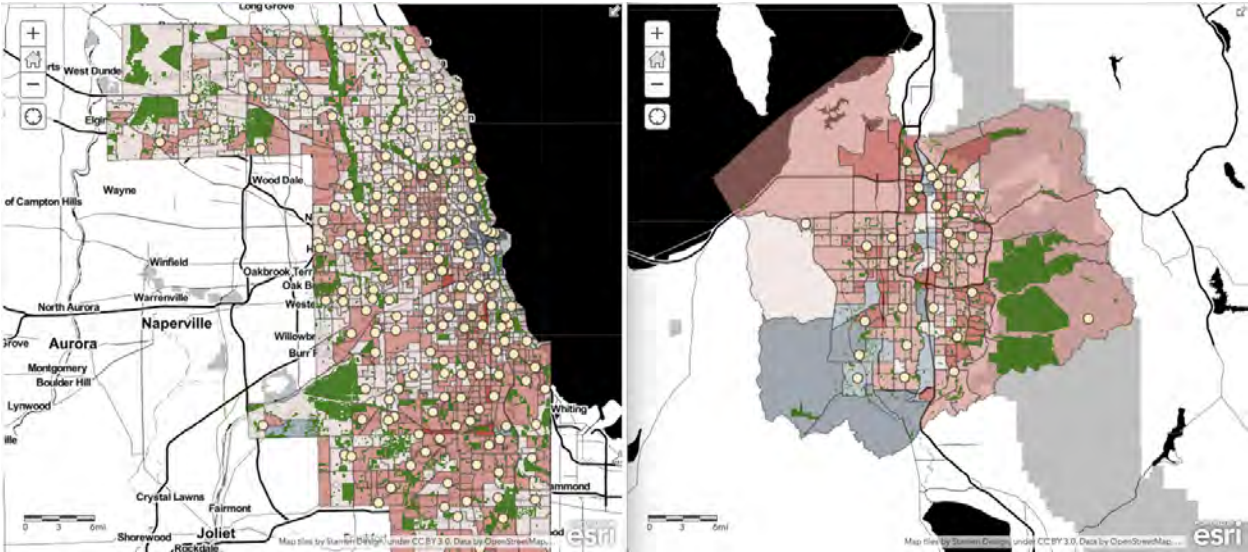

Figure 4: Side by side map with population change (census tract), greenspace (polygon), and libraries (unique locations) layers for Cook County (left) and Salt Lake County (right). Source: Andrew Nelson, 2021

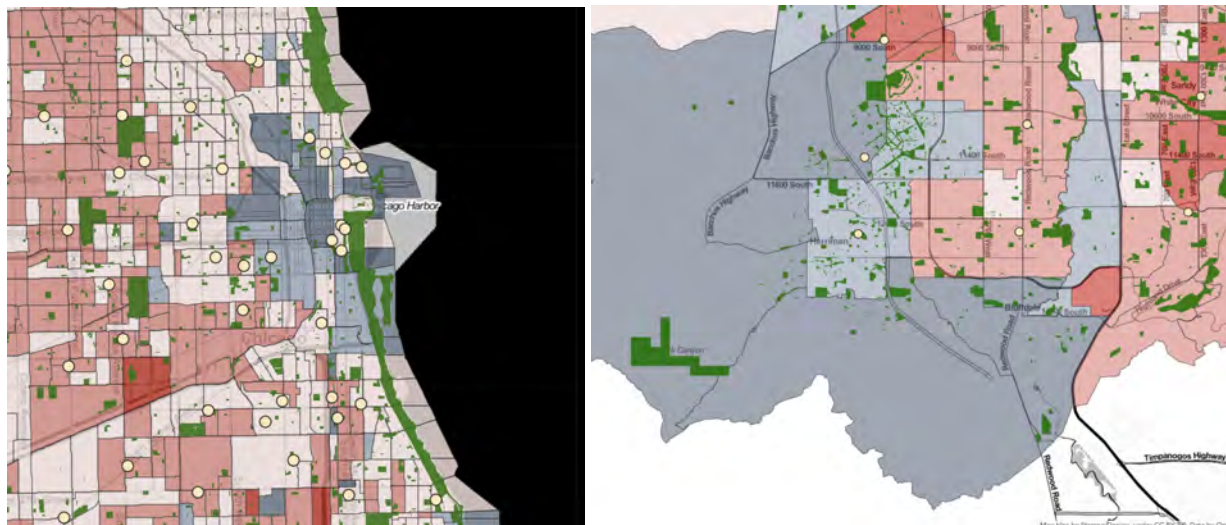

Figure 5: Detail of census tracts with the greatest population growth with greenspace (polygon) and libraries (unique locations) layers for Cook County (left) and Salt Lake County (right). Source: Andrew Nelson, 2021

4.0 CONCLUSION

This early study highlights the value of geospatial analysis in understanding urban populations. These initial few layers already begin to illustrate patterns across factors spaces. The potential for this type of analysis is endless, allowing for potentially hundreds of layers of data to create a more nuanced understanding of communities and discernable differences between cities to understand why each has experienced different population change trends.

This methodology also provides a framework to identify concepts for additional research through human centric data collected in non-spatial ways. Layering data points can also be expanded to include more nuanced factors like those included in studies like the General Social Survey or American Community Survey. An example of this would be looking at an issue like mental health. While an important topic in understanding urban experience, it is challenging to assess a single factor as an indicator of mental health in cities. By combining layers supported by research and literature on mental health indicators, it is possible to understand social-environmental impact in a spatial way and target additional research and resources.

4.1 Challenges

One of the most significant challenges in this study is identification of statistically significant data layers. With much of the data relevant to understanding urban space being collected at the city or state level and often by independent agencies, it is challenging to find equivalent data sets for two cities. Limiting the study to comparable layers restricted the factors for analysis.

Another challenge in this study was the difference of scale between the two cities. For both a visual analysis as well as assessing impact of factors, it was necessary to consider the discrepancies of study size and geographic reach. This challenge is impossible to mitigate and would exist in any cross analysis of cities but important to consider.

4.2 Next Steps for Research

To continue this research, we have identified the necessity to begin the collection of data to support the creation of unique datasets with comparable parameters. Statistically significant analysis hinges on the validity of this data. In developing our own collection strategy, we have also identified potential in non-traditional data sources. Factors such as noise pollution, community art hubs, environmental ecosystems, weather anomalies, and micro-economic data present potential to understand more nuanced elements of urban life than traditionally collected data.

It is also our hope to expand this research to look at additional cities, using the impactful factors identified in this work. By developing a methodology for choosing and collecting unique and significant data, analyzing in a spatial way, and using to guide analysis we can embrace the challenges of comparing asimilar cities and allow for a framework for deeply compelling comparison useful in urban planning initiatives.

REFERENCES

- Blair, John P. and Reese, Laura A. 1999. *Approaches to Economic Development: Readings From Economic Development Quarterly*. USA: Sage Publications.
- Coley, Sullivan, & Kuo. 1997. *Where Does Community Grow?: The Social Context Created by Nature in Urban Public Housing*. USA. Environment and Behavior.
- Greenhalgh, Liz and Warpole, Ken. 2019. *Libraries in a World of Cultural Change*. London: Routledge.
- Sassen, Saskia. 2006. *Cities in a World Economy*. New York, NY: Sociology for a New Century Series.
- Vey, Jennifer. 2007. *Restoring Prosperity: The State Role in Revitalizing America's Older Industrial Cities*. Washington, DC: Metropolitan Policy Program at Brookings and Public Sector Consultants.

The Unreachable Rivers and the Informalities of Medellín and Beirut

Taraneh Meshkani¹

¹Kent State University, Kent, OH

ABSTRACT: Rivers have always played a critical function in the processes of urbanization. Yet, with the industrialization of cities, rivers got buried, canalized, polluted, and confined. In the past decade, there have been initiatives to restore the urban rivers by re-naturalizing, de-canalizing, improving water quality, giving pedestrian access, and transforming land-use of riverbank parcels. However, socioeconomic factors play a significant role in revitalization projects. This research examines the two cities of Beirut in Lebanon and Medellín in Colombia by analyzing the situation of rivers in relation to the informal communities that do not have access to the rivers and need to deal with flooding and pollution problems. More often, the river works as a barrier for these disadvantaged communities, demarcating their neighborhoods from other parts of the city. This phenomenon is evident in many informal neighborhoods (comunas) along the Medellín River and its creeks. The Medellín River Parks project has attempted to create access to the river through de-canalization. Still, projects like this are typically uncommon in informal neighborhoods, and more often, the rivers in comunas are used as dumpsters. Beirut River faces similar problems from entanglement with the sewage system and industrial factories. Downstream neighborhoods end up dealing with pollution. There are proposals such as the RiverLESS project that tackle these issues. This study looks into some of these informal neighborhoods, such as Santa Cruz in Medellín and Bourj Hammoud in Beirut, to uncover opportunities that aim to give back the river to disadvantaged communities. Based on the fieldwork done in the selected communities in both cities, which consists of mapping and interviews with the residents of such neighborhoods, this research adopts a comparative framework to investigate the problems and opportunities of urban waterways.

KEYWORDS: River Revitalization, Informality, Social Inclusion, Medellín, Beirut

INTRODUCTION

Informality is one of the most dominant modes of urbanization today. An estimated 3 billion people will require adequate and affordable housing by 2030 (UN 2019). Informality as a new epistemology for urban planning falls between a gray area of legal and illegal status (AlSayyad; Roy 2003). The notion of informality is reconceptualized by many as “a series of transactions that connect different economies and spaces to one another” (Roy 2005, 148), which does not equate informality with poverty and negates favoring of the formal. In this way, the informal can also include middle class or wealthy urban residents; it does not merely deal with spatial or economic considerations but also includes the social dimension. One example of such differentiation is the notion of static and kinetic cities in India by Rahul Mehrotra.

“The Kinetic City, bazaar-like in form, can be seen as the symbolic image of the emerging urban Indian condition. The processions, weddings, festivals [...] all create an ever-transforming streetscape - a city in constant motion [...]”
(Mehrotra 2008, 207).

Aside from various informal practices, there is often a relationship between formal and informal in many neighborhoods. This relation can be seen in the cities of the global south. For example, in the case of the Bourj Hammoud neighborhood, informality weaves with formerly constructed city blocks. Even though most of the housing in the area is built legally, other informal mechanisms take place in the streets and sidewalks, which constantly shift as spaces for economic exchange, socialization, and play.

On the contrary, in the city of Medellín, informality has been the most affordable source of housing for many. One case study is the Comuna 2, Santa Cruz neighborhood.

In addition to housing, in many informal and underprivileged communities, the citizens rely on rivers as sources of water, sanitation, and sewer systems due to the lack of urban infrastructure. This phenomenon is seen in two cities of Beirut and Medellín. Due to national and international conflict, population growth in both cities has caused high densification and the development of informal communities adjacent to rivers. Many of these neighborhoods are often

built along the urban waterways in steep hills or floodplains where unsuitable for urban development, which make them unsafe and susceptible to natural disasters. The urban growth does not match the housing needs and development of municipal infrastructures that provide clean water supply, waste collection, or public spaces for the communities. Furthermore, the canalization and pollution of the rivers and other wrong development strategies often turned these riparian ecosystems into concrete walls that cause problems for the citizens. Many post-industrial cities are attempting to revitalize the riverbanks for environmental and development opportunities. However, the cities of the global south are at the early stages of rehabilitating their waterways.

1. METHODOLOGY

This paper studies the condition of Medellín and Beirut Rivers in relation to the two residing lower-income, informal urban settlements of Comuna 2, Santa Cruz and Bourj Hammoud. Based on the fieldwork done in the selected communities and planned workshops in both cities, this research adopts a comparative framework as a research methodology.

The finding of the paper is based on the collection of twenty interviews conducted in each city with activists, community citizens, and design scholars in relation to the history of urban planning policies and interventions, the development of selected communities adjacent to the river, the challenges of the rivers concerning informal neighborhoods such as disconnection and lack of public space, problematic riverside developments, and environmental concerns. The paper further analyzes two selected river revitalization projects of Medellín River Park by Latitud S.A.S. and RiverLess by theOtherDada as examples of such initiatives.

In addition to the interviews, this paper studies the already existing literature on river revitalization strategies in relation to informal urban development. The findings of this paper are also based on the fieldwork research conducted in Medellín, Columbia and Beirut, Lebanon in the spring of 2020. During the fieldwork, multiple site visits were conducted to evaluate the river's impact on the selected communities.

The study is critical since the spatial inquiries into the relation of informal settlements and rivers are under-researched and such studies are vital in setting the course for future river rehabilitation projects. Furthermore, even though the urban development strategies that are adopted in the two cities are distinct in terms of the role of private investment in Beirut and the importance of state and municipal sovereignty in Medellín; the comparative approach creates a learning opportunity for cross-pollination of strategies used for the application of urban resilience, social inclusion, and design.

1.1. Case Study: Medellín, Colombia

1.1.1. Medellín Development and Social Urbanism

As the second populous city in Columbia, with over 3.7 million people, Medellín is located in Aburrá Valley, comprising ten municipalities with a distinct topography contributing to its urban growth. The city has been rapidly urbanizing since the 1950s with the implementation of the Medellín Master Plan (MMP), which industrialized the city and called for channelization of the Medellín River and its beautification. The pilot plan for Medellín was directed by Paul Lester Wiener and Josep Lluís Sert, which followed the ideals of city planning by the International Congresses of Modern Architecture (CIAM) that separated functions of living and working (Schnitte 1999).

The city's population grew dramatically in the 1980s resulting in urban informalization. During this time, the hills of the valley were occupied by illegal development in the northern part of the city. The new constitution of Columbia led to the launch of the new initiative, Integrated Program for Improvement of Informal Neighborhoods (PRIMED), that aimed to improve these neighborhoods. Despite the effort, the city's northern part was still segregated from the center and the south, where most of the jobs and industries were concentrated.

Furthermore, in 2004, a series of urban intervention projects were introduced in the city as the keen vision of Mayor Sergio Fajardo, which proposed new urban acupuncture into informal neighborhoods and successfully linked them to the city's metro line. Fajardo's urban redevelopment plan involved improving mobility, education, governance, and civic life transformation in informal neighborhoods. As part of the social urbanism plan, the new system of metro cables was built, which extended the public transit system to informal settlements and developed civic and education spaces such as new schools, spaces of recreation, and libraries adjacent to transit points [Figure 1]. In addition, this plan gave citizens of informal neighborhoods the opportunity to participate in the formal economy and have access to central and southern parts of the city. But most importantly, citizen participation was an integral part of the new plan, which encouraged local decision-making in budgeting, property regulations, and urban interventions.



Figure 1: The Metro Cable of the informal neighborhood as part of the Social Urbanism Plan (Author, 2018)

1.1.2. Medellín River and Comuna 2 (Santa Cruz)

Much has been written about the social urbanism of Medellín; however, there has been less attention to the connection between bodies of water and informal neighborhoods. The Medellín River runs 104 kilometers, and its terrain runs from the hillside in the north to the valley floor in the south of the city. The canalization and straightening of the river began in 1912 and finished with the construction of the metro train in 1985 (Hermelin 2012, 56). The canalization made it possible to construct bridges and recover areas of land in the valley that were previously swamped.

One example of an informal neighborhood is Comuna 2, Santa Cruz, which is the second densest of sixteen comunas in the city of Medellín. High density and lack of empty lots in comunas have caused housing problems. The Territorial Regulation Plan of Medellín (Plan de Ordenamiento Territorial, POT) allows for the construction of up to four to five floors of housing. To build such housing projects, the state needs to buy the existing houses from the current dwellers of the comunas and subsequently relocate them to other neighborhoods. Many of the locals are against the relocation since they will lose their community and livelihood. The Medellín River functions as a divider between the neighborhood and the transit system of the city.

1.2. Case Study: Beirut, Lebanon

1.2.1. Beirut River and Bourj Hammoud

The Beirut River springs from Mount Lebanon and flows all the way to the Mediterranean Sea. The flow of the river is intermittent and it is impacted by rainwater and snowfall. The river flow variations go from “16 cubic meters per second in the wet season and 0.1 cubic meters per second in the dry season.” (Frem 2009, 96) In 1934, the Dechounye Dam and Beirut River Canal was built by the French in order to modernize agriculture in the city (Frem 2009, 31).

Due to modernization of the city and immigration to Beirut, the river banks also got urbanized. Following the fall of Ottoman rule and the new era under the French order, many Armenians settled in the Beirut neighborhoods of Bourj Hammoud on the east side of the Beirut River in 1915. The area was originally established as a refugee camp on empty agricultural lands, but the residents developed the neighborhood into a dense and thriving community over time [Figure 2].



Figure 2: Bourj Hammoud (Author, 2018)

The settlements of Bourj Hammoud were established based on the formation of several quarters. Each zone was developed based on a grid of streets with a church, school, or other institutional buildings at its core and small plots of land which range between 50 to 150 sqm. Over the years, the grids expanded in different directions and merged with other zones. In addition, the plots were densified as bigger houses with more stories were built to accommodate more Armenians from Lebanon and other countries. On the other hand, Karm Zeitoun, another Armenian neighborhood, could not expand because of the steep topography of Achrafieh Hills which enclosed it. Today, Bourj Hammoud is one of the densest neighborhoods in Beirut with both formal and informal characteristics.

2. FINDINGS

Based on the interviews and the fieldwork research conducted in the two selected neighborhoods in relation to their riverscapes, this paper further highlights findings on the three categories of comparative analysis namely the disconnection and lack of public space, the problematic riverside developments, and the environmental concerns.

2.1. Disconnection and Lack of Public Space

In both cities, access to the river remains scarce and there are very few spaces dedicated for public use. In the Santa Cruz neighborhood, there are no paths to the riverside which raises safety concerns for residents who attempt to reach the river. The river is canalized in parts, and is contributing to the disconnection to the rest of the city. In addition, the neighborhood is very dense and there are very limited community spaces. Hence, there is plenty of potential for the creation of riparian ecology and public green spaces along the river.

Similar to the northern part of Medellín River, the canalized Beirut River has also created a barrier disconnecting Bourj Hammoud from central Beirut to its west. Aside from the river, a major highway also cuts through the area, further breaking up the community. The canalization has created a disconnection between people and the river to the extent that many do not know that the river exists. Moreover, as the canal dissects the city, it has also created problems with vehicular access. Similar to Santa Cruz, Bourj Hammoud neighborhood is also very dense and aside from the street with stores, there are not that many green parks and public spaces available for the community. There is a memorial for Armenians built close to the river on the edge of the neighborhood. However, as a public space, it is rarely utilized. The de-canalization of the river, the creation of a riparian zone, along with the connection to the memorial can create a green open environment that can be used by the residents.

2.2. Problematic Riverside Developments

Another major problem that both neighborhoods face is their proximity to the riverside which in times of flood, creates an unsafe environment.

For instance, in neighborhoods of Medellín that border with the river, such as Santa Cruz, houses have columns in the water. When the River floods, it is unsafe for people, especially for the children who live nearby. There have been incidents of drowning as a result of river flooding in these neighborhoods [Figure 3].



Figure 3: Medellín river canalization and the informal neighborhood of Santa Cruz (Author, 2018)

On the other hand, in Beirut, aside from buildings, a street runs alongside the river neighborhood of Bourj Hammoud, and when it floods, since the lack of riparian area, the vehicular flow to the neighborhood is impacted.

Besides, the government views the river as a resource even without water. For example, in 2013, the Ministry of Energy and Water introduced a renewable energy initiative, the Beirut River Solar Snake Project (BRSS), which planned to cover the river with solar panels [Figure 4]. The project was implemented by the Lebanese Center for Energy Conservation (LCEC). With land scarcity in the city, the dried-out polluted river finds a new life as land for the installation of solar panels and a site for electricity generation. The solar snake covers 300 meters of the river in its first phase.



Figure 4: The Beirut River Solar Snake Project (Adib Dada, 2019)

This strategy, along with canalization, further buries the river and hides it from the neighborhoods. For the people in the dense neighborhood of Bourj Hammoud, not only is there no access to the river, their visual view has also been completely blocked. There have been design proposals such as Beirut RiverLESS, which propose strategies to give back the river to these disadvantaged communities.

Moreover, the canalization of the river has changed its course to a straight line that has left some empty spaces on both sides with unclear ownership. An interesting example is a market space, Souk el-Ahad, claimed by the Ministry of Water and Energy and Municipality of Beirut, with each having different plans for this land [Figure 5].



Figure 5: Souk el-Ahad (Author, 2018)

2.3. Environmental Concerns

River pollution has been a problem in both cities. In Santa Cruz, there are eleven creeks that are places where people dump their garbage [Figure 6]. Both the Medellín River and the creeks are extremely contaminated. As a result, the typology of houses adjacent to the creeks has their backs to the body of water to avoid the smell and pollution caused by the garbage and sewer. Moreover, since the creeks are channelized, they interrupt vehicular and pedestrian access and are isolated from each other and the rest of the city.



Figure 6: The pollution in the creeks of informal neighborhoods in Medellín (Author, 2018)

The Bourj Hammoud neighborhood also has a variety of environmental issues which impact the way of life for the residence. The river is contaminated and is a major source of pollution for the community [Figure 7]. Other pollutants are formed as a result of heavy traffic and the nearby Karantina slaughterhouse, which produces a terrible odor. There are also plans to establish a future wastewater facility that will further cause environmental degradation in the neighborhood. The Beirut River is seen only as an open sewer system by the community. There is also industrial waste dumped into the river from the Mansourieh area, making the river into an industrial sewer system.



Figure 7: Pollution in Beirut River (Author, 2018)

Historically, the Beirut River has provided “ecosystem services” to the city, such as providing fresh water, mitigation from storms and floods, maintaining a diverse ecological ecosystem, and being a focal point for cultural and community activities. However, with a lack of government oversight and regulations, pollution is changing the utilization of the river for downstream communities, turning it into a no man’s land. The neglect further exacerbates the environmental challenges of the river.

The areas that initially hosted the immigrants are situated in the mouth of the Beirut River and are floodable riverbanks that were not appealing sites. The flow of the river is influenced mainly by rainfall and snowmelt and as a mountain watercourse with changing topography. As a result, the river becomes very dry during the summer, and it floods during the winter. The floods of Beirut River and the 1955 floods of Abou Ali River in Tripoli killed nearly 160 people that resulted in the canalization of the river.

3. THE ANALYSIS OF THE TWO MAJOR RIVER REVITALIZATIONS PROJECTS

3.1. Beirut RiverLESS

Beirut RiverLESS is a project by theOtherDada which was initiated in 2013 as a strategy to bring back the Beirut River into life. The project utilized methods of engaging the public in the decision-making by organizing community meetings, focus groups, and mapping exercises with the locals, among other strategies. Through partnering with local and regional stakeholders such as Lebanese Center for Energy Conservation and UN-Habitat and other non-profit organizations such as TandemWorks, the office proposed a series of small-scale urban interventions like rainwater collection by utilizing rooftops, pollution reduction, and flood managing through the Blue-Green Street initiative, designing of urban parks for local communities, and urban art interventions to raise awareness about the river.

The firm also proposed a Beirut River Afforestation project, partnering with Afforestt and SUGi, which planned a two-hundred-square-mile urban forest to improve the river’s environmental problems. The project used sixteen different native vegetation and planted over 1,200 trees. Similar to the previous projects, the firm utilized strategies for community engagement that informed the public and design professionals in understanding the native ecosystem and empowering them to transform the urban river ecology.

3.2. Parques del Río Medellín

In Medellín, there are not many initiatives that attempt to address the connection of the river with informal neighborhoods. However, there have been projects in other parts of the city that tried to reimagine the river not as a concrete wall that dissects the city but as an ecological system that can be integrated with city infrastructure to create a landscape for public encounters. One example of such a project is Parques del Río Medellín, Medellín River Park, by Sebastian Monsalve Gomez and Juan David Hoyos Taborda. The Park expands for 20 kilometers, which also bridges over the river and highway to connect two separate sides of the city. The integration between the park and the adjacent neighborhood makes the site a public space for citizens.

Projects such as Medellín River Park have successfully changed the riverbank in Medellín and raised awareness about the river as an ecological asset for the city. However, there has not been similar attention given to the northern part of the river where informal neighborhoods exist. The lack of green and civic spaces in these neighborhoods asks for such interventions.

CONCLUSION

Rivers have traditionally played a central role in the city landscape and urban development. But as cities develop and flourish into denser neighborhoods, the negative impact of growth hinders the river's natural ecosystem. As industrialization takes precedence over other aspects of city life, the river becomes canalized, polluted, and eventually becomes a no man's land. The two examples of the Beirut and Medellín rivers demonstrate the degrading impact which follows the lack of oversight and regulations around the river. In informal neighborhoods, the river's utility becomes the private property of those who have direct access to it. Revitalization projects can have a great impact on the city and more importantly, on informal neighborhoods such as connecting them to the rest of the urban fabric, revitalizing the river edge in order to provide public space for these communities, mitigate river pollution and other environmental concerns that jeopardize the safety of residents, and halt the problematic development along the riversides. However, since informal neighborhoods are developed organically without central planning, government oversight, and regulation, a revitalization project needs to incorporate the points of view of the local residents rather than function as a centralized, top-down planning initiative. If rivers are integrated appropriately within the city landscape, they can provide multiple benefits to a variety of stakeholders.

REFERENCES

- Alcaldía de Medellín. Plan de Desarrollo Municipal 2004 -2007. 2004. Medellín, Compromiso de Toda la Ciudadanía. Medellín.
- Alcaldía de Medellín. Plan de Ordenamiento Territorial. Medellín: Alcaldía de Medellín. 2006.
- AlSayyad, Nezar, and Ananya Roy, eds. 2003. *Urban Informality: Transnational Perspectives from the Middle East, Latin America, and South Asia*. Lexington Books.
- Arboux, Michel Hermelin, Alejandro Echeverri Restrepo, and Jorge Giraldo. 2012. *Medellín: environment urbanism society*. Universidad EAFIT.
- Betancur, John J. 2007. "Approaches to the regularization of informal settlements: the case of PRIMED in Medellín, Colombia." *Global Urban Development* 3.1, 1-15.
- Botero Herrera, F. 1996. "Barrios Populares en Medellín". *Historia de Medellín*. Vol.1. Medellín: Suramericana de Seguros.
- Davis, Mike. 2007. *Planet of Slums*. Paperback ed. London; New York: Verso.
- Echeverri, Alejandro, and Francesco M. Orsini. 2011. "Informalidad y urbanismo social en Medellín." *Sostenible?* 12: 11-24.
- Economist. 2014. "Medellín's comeback: the trouble with miracles." *The Economist*.
- Frem, Sandra. 2009. *Nahr Beirut: projections on an infrastructural landscape*. Diss. Massachusetts Institute of Technology, Department of Architecture.
- Galvin, Madeleine, and Anne Maassen. 2020. "Connecting Formal and Informal Spaces: a Long-Term and Multi-Level View of Medellín's Metrocable." *Urban Transformations* 2 (1): 1–9.
- Adler, Gerald, and Manolo Guerci. 2019. *Riverine*. 1st ed. Milton: Routledge.
- Hermelin, Michel. 2012. "Human Impact." *Medellín: environment urbanism society*.
- Kooy, Michelle. 2014. "Developing Informality: The Production of Jakarta's Urban Waterscape." *Water Alternatives* 7, no. 1.
- "Make cities and human settlements inclusive, safe, resilient and sustainable." 2019. *United Nations Report*.
- Mehrotra, Rahul. 2008. "Negotiating the static and kinetic cities: the emergent urbanism of Mumbai." *Other cities, other worlds*. Duke University Press, 205-218.
- Meshkani, Taraneh, ed. 2020. *River, Nahr, Río: A Riverscape Analysis of Cleveland, Beirut, and Medellín*. College of Architecture & Environmental Design, Kent State University.
- O'Neill, Karen M. 2006. *Rivers by design*. Duke University Press.
- Prominski, Martin, Antje Stokman, Daniel Stimberg, Hinnerk Voermanek, Susanne Zeller, and Katarina Bajc. 2017. *River. space. design: planning strategies, methods and projects for urban rivers*. Birkhäuser.
- Roy, Ananya. 2005. "Urban informality: toward an epistemology of planning." *Journal of the American Planning Association* 71.2: 147-158.
- Samper, Jota. 2017. "Eroded resilience, Informal settlements predictable urban growth implications for self-governance in the context of urban violence in Medellín, Colombia." *UPLanD-Journal of Urban Planning, Landscape & environmental Design* 2.2: 183-206.
- Schnitter, Patricia. 1999. "Pilot plan proposal for Medellín by Wiener and Sert: CIAM's theory of urban planning—its transfer to practice." In *Proceedings of the ACSA International Conference*, pp. 217-221. Rome: ACSA.
- Turok, Ivan. 2014. "The seventh world urban forum in Medellín: Lessons for city transformation." *Local Economy* 29.6-7: 575-578.

Viral Resiliency: Reconstructing Extra-Legal Settlements Through Dialogical Practices

Scott Gerald Shall¹

¹Lawrence Technological University, Southfield, MI



Figure 1: Extra-legal settlements, such as the one shown above, have grown exponentially over the last few decades, often in the face of powerful opposition. (John Miller 2018)

ABSTRACT: Incredibly resilient urban environments already exist. They are just created without the support of design professionals. Built using unapproved methods, on unowned land, with unsanctioned materials, these extra-legal settlements have thrived within the crucible of modern urban development, growing at a rate far exceeding that of state-sanctioned urban areas (WHO, 2000). This is despite the fact that these settlements are disadvantaged in almost every way: underfunded, built on undesirable, or outright dangerous, sites, and overtly opposed by governing authorities (UN-Habitat, 2010). Nevertheless, they continue to multiply, now housing more people than the legally-sanctioned and professionally-design urban cores they surround.

This is not to state that these settlements – which, by definition, lack safe shelter and adequate resources – could not benefit from greater financial, legal, and professional support. They undoubtedly would. However, to be effective, this help must be offered in a manner that is attuned to the unique nature of these shadow cities and not through the importation of practices used to realize their legal counterparts (Theime and Kovaks, 2015). For doing so will generate ineffective, *malevolent urbanism*, instead of the truly dialogical work, effectively compromising the ability of the designer to leverage the inherent resiliency of these settings in order to offer a more sustainable urban address (Friere, 2010).

The paper proposed by this abstract will explore a more dialogical approach by studying the resiliency and health of several design actions that have been executed within extra-legal communities using a more collaborative professional framework. Constructed of mostly scavenged means in only a few days with budgets of less than \$2000, these modest architectures will be studied to understand their efficacy as not only a project, but as a generator of new projects, executed virally and without professional support.

KEYWORDS: extra-legal settlements, bricolage, viral resiliency, socially-responsive architecture, humanitarian design, public health, human-centered design

INTRODUCTION

Extra-legal settlements demonstrate incredible resiliency, just not in a manner aligned with the definitions proposed by the professionals responsible for the design and construction of their legal counterpart.¹ Theirs in an overt resiliency, manifest in the unprecedented growth and propagation of these urban areas around the world without external support and in the face of very powerful opposition (Figure 1). Whether burned to the ground, demolished by rains or removed by government agencies, these settlements not only persist, but they grow. Properly understood, this amazing elasticity offers architects a number of tactics toward realizing more resilient work. Arguably, if those responsible for the design and construction of the built environment can successfully translate these lessons, they may become better equipped to realize settlements that are able to persist in the face of mounting environmental and political pressure for all people, regardless of the legality of their community.

1.0 THE RESILIENCY OF EXTRA-LEGAL SETTLEMENTS

To understand the unique resiliency of extra-legal settlements, one must first look into the history of their formation. Although the word “slum” was initially used in the 1820s to describe, offensively, the poorest and most unhygienic housing areas of London, the settlements of today find their root in the period of rampant economic growth immediately after the Great Depression, when there was a pronounced need for cheap labor in order to support a rapidly globalizing marketplace. This growth, and the attendant need for labor, increased dramatically after the fall of the Iron Curtain, creating an economic expansion that far exceeded the ability of many countries to support it. Correspondingly, these states fell far short of their goals to promote the fair distribution of wealth within their borders, causing sharp inflationary pressures that forced many lower-income people to turn to the informal economy in order to survive. As recessions gripped much of the world later in the century, the migration from rural to peri-urban and urban environments dramatically increased, as rural residents fled their farms for the city in order to try to earn a living wage. Unfortunately, the developing world – which housed the majority of the world’s working age population and thus experienced most of this population shift - did not have the resources to bring these semi-skilled workers into the formal sector, exacerbating the already unsustainable growth of informal sectors, and settlements. The quality of life within the extra-legal settlement deteriorated rapidly due to overcrowding (Habitat for Humanity, 2018). Over the next several decades, this state of affairs would only become more dire as the number of people settling in these areas increased exponentially, due to not only to continued migration but to the natural population growth of what had become huge communities (Nianias, 2016) (Figure 2).²

Urban and rural population projected to 2050, World, 1500 to 2050

Total urban and rural population, given as estimates to 2016, and UN projections to 2050. Projections are based on the UN World Urbanization Prospects and its median fertility scenario.

Our World
in Data

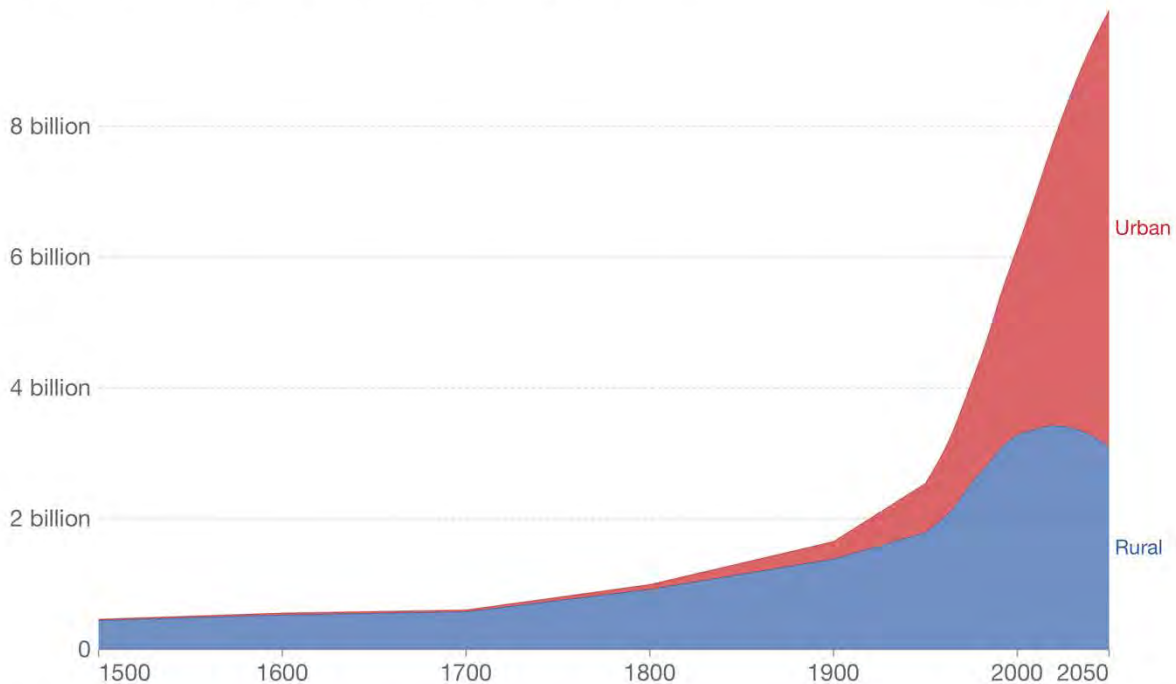

Source: OWID based on UN World Urbanization Prospects 2018 and historical sources (see Sources)

CC BY

Figure 2: Urban areas are projected to see explosive growth over the next three decades, much of which will occur in extra-legal settlements within the developing world. (Global Change Data Lab, 2018)

To date, three responses have been offered to address the unhealthy and unsustainable conditions found within these extra-legal settlements. The first is overt opposition. Manifest in blatant state-sponsored clearing or more covert activities, such as the demolition of these communities through arson, this approach is often deployed when economics demand that the extra-legal settlement be cleared immediately so as to make way for better-funded development (Sorensen, 2016). Although this approach has worked at times, it has not proven to be a particularly effective strategy within the well-connected contemporary world, where the nature of these activities creates powerful scenes that are ready-made for dissemination through global news outlets and social media. Once disseminated, these powerful scenes engender intense backlash, often resulting in the delay of the proposed development which inspired the clearing in the first place. This delay will give the residents of the settlement all the time they need to rebuild (Majola, 2020).



Figure 3: In an effort to resettle the residents of an extra-legal settlement and commandeer their land for new development, the Slum Resettlement Authority moved thousands of people to this compound in the Mankhurd section of Mumbai. (Noah Addis, 2012).

The second response to addressing the issues faced by the residents of extra-legal settlements is to simply resettle them in a different part of the city (Figure 3). Although much more resource intensive than the first strategy, this approach has also been more effective, at least when done properly. However, proper resettlement often proves impossible, for two reasons. First, in order to survive, the residents of extra-legal settlements develop rich networks of informal, social support. These networks provide essential assistance for the residents: trusted friends to watch the kids after school so that both parents might work, someone to keep an eye on the home while the family is away, or a community of neighbors ready to provide emergency assistance whenever disaster strikes. The architecture of the new settlement, which is generally based upon high-density, tower-based typologies, provides a much more isolating environment, severing the residents from this essential infrastructure. This isolation can prompt the newly-resettled residents to reject the offered housing and return to the extra-legal settlement only months after moving (Nianias, 2016). Second, the resources required to realize a properly articulated resettlement strategy are generally not made available. For governments, the costs associated with proper resettlement are simply not feasible. For private developers – who are sometimes only permitted to build lucrative projects on the lands currently occupied by extra-legal settlements if they resettle the populace – there is no incentive to provide these resources, as their legal obligation can be met with

a much less generous allocation (Anand and Parussini, 2017). This cost-cutting results in the deployment of poor-quality structures on undesirable or dangerous properties. For example, in 2018, five thousand residents of an extra-legal settlement in India were evicted and their homes, so that they might be demolished by the Brihanmumbai Municipal Corporation, in order to pave the way for a massive new tower complex. The displaced residents were offered new housing on land adjoining a massive oil refinery in a different part of the city. Today, only three years later, 90% of the residents who elected to stay within the offered housing have health problems (WatchScroll, 2018). Either way, the inadequacy of the offered housing once again provides a compelling story for global and social media, creating the same backlash as the first strategy. Only at greater cost.

The third response to the various ailments experienced by the residents of extra-legal settlements is to rebuild them on the site already inhabited and transform the existing settlement into a more sustainable, hygienic and safe community. This is, by far, the most efficacious strategy. By addressing the core characteristics that define the extra-legal settlement in the first place, this approach effectively eliminates it, at least if one defines it using the definition for “slum” provided by organizations like the United Nations (UN-Habitat, 2010). Unfortunately, however, these successes mask a deeper reality. Although the conditions found within the settlement have improved, the settlements themselves remain isolated from the rest of the city and much of the infrastructure that serves it (Figure 4). Additionally, the suffocating density and overriding poverty that created the poor conditions in the first place remain largely unaddressed. Ironically, in fact, this approach exacerbates them. This is because the improvements made to the settlement make it more attractive to the impoverished citizens of the country, inspiring others to move to this specific location. This increases the size and density of the recently improved community rapidly – growth that cannot be sustained by the community nor the newly-installed support system. Relatively quickly, the settlement deteriorates, becoming just as unsafe, unhygienic and unsustainable as it was before the intervention - a situation that has played out within improved extra-legal settlements around the globe over the last few decades.³

From this history, it is clear that whatever the tactic taken to address their circumstances, extra-legal settlements will continue to propagate unless the underlying economic realities that prompt their formation are addressed. Although a regrettable resiliency, misaligned with healthy, or desirable, development practices, it remains a potent force, capable of remarkable growth in the face of immense, and well-funded, opposition, and without any external support - conditions that would lead to the immediate demise of much better supported communities. Perhaps by better understanding the nature of these settlements, and the reasons for their resiliency, those who design the built environment might use these tactics to develop more efficacious practices for addressing not only the significant issues faced by the residents of these settlements, but also the substantial social and environmental issues confronting all citizens around the world.

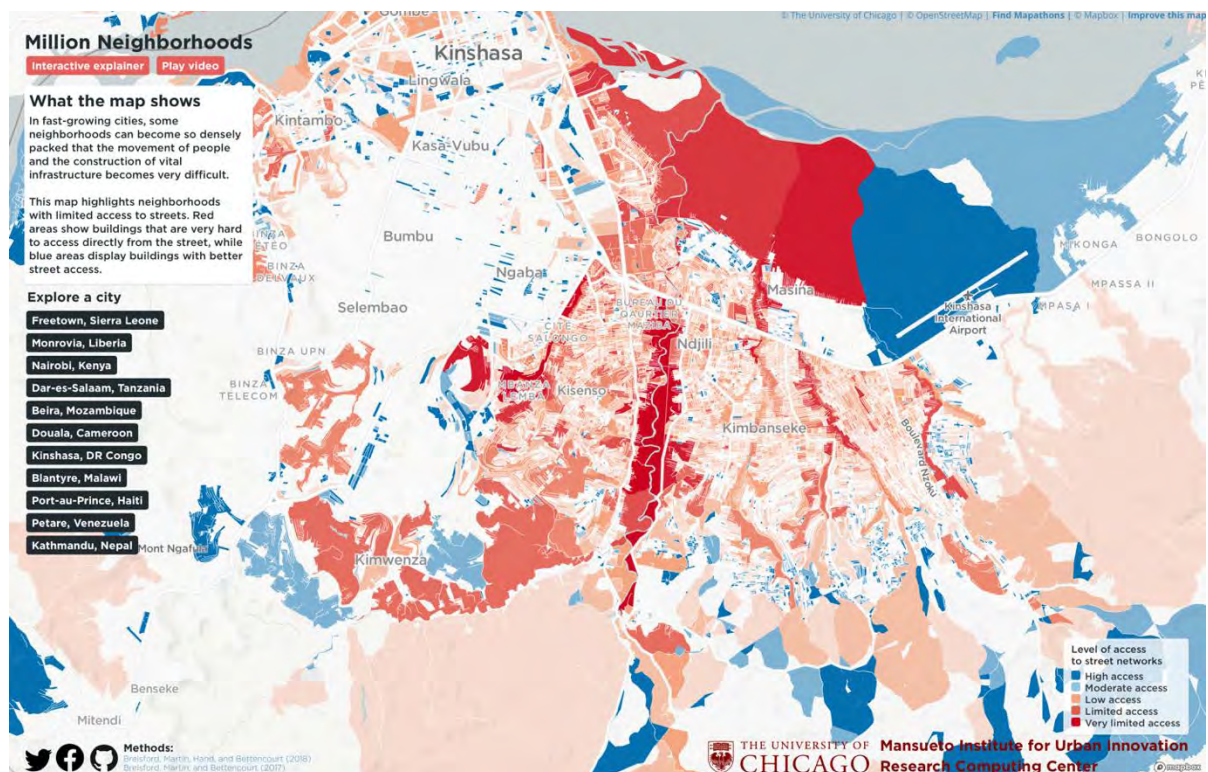

Figure 4: Providing access to essential infrastructure within extra-legal settlements is a difficult proposition, leading to it becoming an expensive and rare occurrence. This rarity increases its value to those needing to live within these communities, encouraging more migration to these areas, and a return to the unsafe, unhygienic and unsustainable conditions that inspired the address. (University of Chicago, 2020)

2.0 DEVELOPING ASPIRATIONAL RESILIENCY, AND HEALTHY COMMUNITIES

The history of extra-legal settlements, and recent efforts to reform them, make it clear that addressing the myriad issues confronting the residents is not simply a matter of providing additional resources – although this is obviously required – but of allocating these resources in a manner that more strategically aligns with the innate growth patterns of the settlements themselves. Only then will these interventions become able to leverage the momentum found within the settlement itself in order to promote a sustainable shift toward healthier outcomes. Stated another way, by capitalizing upon the *inherent resiliency* of extra-legal settlements, those responsible for the design and construction of the built environment might help these settlements realize the more *aspirational resiliency* favored by these professionals.

When studying the inherent resiliency of the extra-legal settlement, four such strategies emerge:



Figure 5: Through many, inexpensive small-scale works, the International Design Clinic created robust platforms of exchange in Bolivia, through which large-scale collaborations were formed and new educational opportunities realized for homeless children. (International Design Clinic, 2015)

2.1 Strategy 01: Understanding Values

Extra-legal settlements form as an outgrowth of the collected values held by a wide, and growing, segment of the population. For them to grow in a more sustainable fashion, the tactics toward that end must be rooted upon these values and not those held by the designer or planner, no matter their nobility or rightness. To illustrate, in 2018 a massive fire destroyed an extra-legal community in Mansarovar Park of eastern New Delhi. As the residents worked to rebuild, a handful of NGOs and local designers decided to help the residents do so in a smarter, more sustainable fashion. The proposals that resulted were quite ingenious, utilizing inexpensive, light-weight and non-flammable materials to not only rebuild the community, but to do so with assets that could be transported to a new site whenever the residents were inevitably evicted from their current home. Unfortunately, very few of these ideas were ever implemented. Some of the offered ideas were rejected due to timing: the residents had already purchased materials or rebuilt by the time the proposals were made. Others, due to cost: the proposed materials, although inexpensive by the standards of normative architectural production, were more expensive than the ones popularly used within the extra-legal settlement. Still others were rejected because the residents feared that the new strategies would lead to a community that appeared too permanent, which would undoubtedly draw the attention of the governing authorities. In fact, the only ideas implemented – moving cooking fires outside the home and widening the lanes between structures - were those that could be realized without additional cost or upsetting the core values of the community. All other ideas, no matter how efficacious they were in the eyes of those proposing them, were summarily rejected (Malhotra, 2018).

Complicating this is the fact that the value structure of any community is generally complex and ever-changing – a reality that becomes especially problematic when experts from a community holding one set of values attempt to generate work that is attached to the values held by a different community, as is the case when architects, designers and other professionals who design legal settlements attempt to design work within extra-legal settlements.⁴ In fact, often such interventions can have an unanticipated, negative outcome, creating what researchers Thieme and Kovacs identify as *malevolent urbanism*.⁵ In order to address this, those designing the built environment must approach the task more humbly and more concretely. To design more humbly, the designer should strive for an alignment between the size, cost and complexity of the offered work and their understanding – a mandate that will invariably result in very small, inexpensive work, at least initially. To design more concretely, the designer should eschew techniques that present their ideas as abstractions, which are difficult for the uninitiated to fully appreciate, and instead to test their ideas by bringing them to bear directly on the situation. In this way - by developing many small-scale, direct engagements - those attempting to build well within extra-legal settlements solicit the responses of residents to new innovations, directly and without abstraction. This allows the interventions to become clearer, more approachable, and less predetermined, reversing the flows of knowledge and cultivating the authentic dialogues described by Friere.⁶ In the previous example, many of the innovations that were rejected by the community might have been translated into more useful forms if small-scale versions had been implemented, and their insight solicited (Figure 5). Through such humble works, the designer creates platforms of exchange that “draw on the knowledge of stakeholders involved in the improvement of slums” and “facilitate information and experience exchange as well as peer learning opportunities” (UN-Habitat, 2015, 3). Viewed as a conjoined set of proposals, these small-scale negotiable works allow “for meaningful negotiations and encounters between local communities, local authorities, development agencies and the entrepreneurial sectors” to emerge, to the betterment of the community in terms aligned with both sets of values (Thieme & Kovacs, 2015, 15).



Figure 6: In realizing this work in South Africa, the designers worked as bricoleurs, developing a community makerspace using only common tools and reclaimed materials. The resulting project, which cost less than \$1500, has successfully changed the manner in which new projects are developed within this community. (International Design Clinic, 2020)

2.2 Strategy 02: Leveraging Accessible Means

This exhortation toward humility is strategically aligned with the formation of the extra-legal settlement itself, which, despite its size and complexity, was forged through millions of small-scale efforts coordinated effortlessly by the residents, often without expression, in accordance with the value structure earlier cited. Over time, these efforts accumulate, creating dizzyingly complex urban structures housing millions of people, built without permission, professional support, or legal jurisdiction. Obviously, the professionals who design and construct the legal counterpoint to these extra-legal settlements rarely operate in this manner – a situation that can lead to disastrous consequences whenever they attempt to do so.⁷ Returning to the example cited earlier, although the work was ineffective, it was not harmful. This is because the architect proposing it worked humbly, deploying a dialogical strategy to design a relatively small-scale series of works, which would only garner scale if adopted and deployed by the community. Unfortunately,

in many cases the dialogical process and scalar restraint exhibited in this particular work do not exist, as those proposing the change default to the values of the patron sponsoring the project instead of the community receiving it (Stevens, 1998). The fact that these imposed values and goals – housing massive numbers of people at low cost, efficiently providing water to huge settlements, or offering other large-scale community assets - are commendable offers a tacit license for those proposing the built work to undervalue the insight of those served by the work and ignore the manner that the community had been providing these same resources to date (Crawford, 1991). This creates massively-scaled, well-intentioned work that is completely unrooted from the realities of the community, and thus destined to fail. Because the work is not linked to the most immediate or pressing concerns held by the community, they do not value it and thus cannot advocate for it. Because it is offered using materials and technologies foreign to the community, they do not understand it and thus cannot maintain it. And because it is imposed at a massive scale, they view it as an offensive disruption to activities and infrastructures that are more highly valued. It is only natural, then, for the members of the community to translate the offered work into terms they understand and value more: cannibalizing parts to meet more immediate needs; commandeering programmed spaces to more useful purposes; or stealing and selling valuable components to purchase items able to address more dire concerns. It is instructive to note that the failure of many government-sponsored housing initiatives is not linked to the siting within dangerously polluted lands, but because the design of the provided housing prioritized the provision of efficient, private spaces for individual residents, rather than support for the highly-valued social infrastructures forged through the pressures of life in an extra-legal settlement.



Figure 7: This residence, completed one year after the Community Makerspace in Figure 6, was designed and constructed without any support from the architects responsible for the initial work. Nevertheless, it is strongly influenced by it, borrowing many approaches in order to allow the new work to achieve greater spans and more durable results at a lower cost. (Kevin Kimwelle, Indalo World, 2021)

Critically, then, to encourage the investment needed to develop any proposal fully, the offered interventions must not only be rooted upon the values held by the community, but also the manner in which these values have prioritized certain approaches to construction. Else those proposing the work will invariably offer a material expression foreign to the community – a situation that is just as dangerous as basing the design upon an imposed value structure, as described earlier. Large-scale works realized by industrially-produced materials and industry-standard technologies make a great deal of sense when judged by the metrics favored by those paying for the work, and the professionals trained to design it. However, when judged using the metrics favored by the residents of the settlement, a different story emerges.⁸ Built using unapproved methods on land that illegally acquired, the residents of extra-legal settlements operate as bricoleurs, which is quite distinct from the operations of the engineer or architect (UN-Habitat, 2012). In the extra-legal settlement, people build using pre-constrained elements, allowing the design to emerge in response to whatever is at hand. If these elements are refined, they are refined in accordance with local custom, based upon tested knowledge and direct engagement (Theime and Kovacs, 2015). Electricity is not provided by an assumed connection to the civic grid but through a set of local negotiations that allow the community to borrow this power without cost – an infrastructure of support that is refined over time through direct, localized testing and development. The resident-

builders of extra-legal communities build within a network of virally-propagated wisdom: how to best use tarp to collect rainwater, when the next government sweep is to take place, which parts of the electrical grid are least protected (Davis, 2006). As such, the resident-builder sees no reason to establish practices of construction that would require rigid hierarchies or isolating practices. After all, their entire settlement exists in defiance of these hierarchies. This forms the nexus by which all great ideas are adopted in the extra-legal settlement. Any idea built in this manner has a chance of propagation (Figure 6). Those that are not will inevitably atrophy (Shall, 2020).

2.3 Strategy 03: Unleashing Viral Propagation

Returning to the observation earlier made regarding extra-legal settlements being a product of millions of small-scale efforts, it is important to note that not all of the ideas forged by the pressures of extra-legal settlements are successful. In fact, the vast majority of ideas actually fail. Many others only succeed marginally. However, because none of these initiatives were imposed at a large-scale or with great expense, they can be quickly replaced by ideas that are more efficacious. If one homeowner attaches the tarp providing them cover from the rain in a manner that creates too much stress, causing failure, residents with smarter approaches quickly offer assistance. As this process plays out across the community to address myriad issues – where to obtain cheap food, how build effectively using corrugated metal, when to sell your goods – the most efficacious ideas propagate widely, creating a massive inventory of approaches that are hard-wired to the conditions found within the extra-legal settlement. Conventions of sustainable practice are thereby established. It is interesting to note that this pattern of engagement is aligned well with contemporary research into crowd-sourcing. To illustrate, the betting line at the Mirage is established not through the insight of experts, but through hundreds of thousands of independent actors who are incentivized (by placing money on a certain result) to use all insight available to them in order to make the best prediction they can. Although several actors may trade notes in this process and experts will likely be consulted, at the time of the bet each actor operates alone. And it is this independence that allows for the Mirage betting line to be one of the best predictors of future outcomes on the planet (Surowiecki, 2005).

To tap into this powerful, crowd-sourcing network, those who wish to offer more sustainable or resilient approaches to life within the extra-legal must insert more efficacious approaches - defined by the terms, materials, technologies and processes valued by the community – into this system. Although foreign to the design professional, this methodology has become central to many other professionals, including those engaged in software development. For decades, software has been developed by releasing the code to those who will one day utilize it and then inviting them to test out the product. Each member of this community engages the offered code and, using their unique base of knowledge and experience, offers tactics to improve it. Not only does this process allow the software to quickly find, and address, any bugs in the system, but it also allows for the offered work to successfully address needs that have proven too complex for more hierarchical processes to solve. For example, after years of study, scientists were unable to discern the structure of a protein-cutting enzyme from a particular virus. In response, the scientists shared what they had uncovered to the gamer community, challenging them to produce an accurate model of the enzyme. The gamers completed the task in three weeks (Gray, Leslie 2011). It is not difficult to imagine how a similar strategy, unleashed within a community already operating in this manner, might allow for the residents to create new approaches to water collection, sanitation, or housing construction (Figure 7).

2.4 Strategy 04: Encouraging Hybridization

The pressures of life within extra-legal settlements prevent the wide-spread use of single-purpose elements. In the extra-legal settlement bowls for cooking are also bathing vessels and emergency rain-catchment in times of need, bamboo rafters provide not only a means to structure the roof of a home, but also a storage system or drying rack for clothes, and plastic tarps for covering goods function not only as a surface to greater security, but also a communication strategy. This multi-use strategy, forged through scarcity of resource, operates at myriad scales, from small-scale goods to the design of the settlement itself. This cross-pollination of function is in sharp contrast to the manner in which large-scale interventions generally operate.⁹ This is because those sponsoring this type of work are generally funding it through monies earmarked for specific purpose, with very clearly defined metrics of success: the provision of 50,000 homes, the cleaning of 100,000 gallons of water, or the education of 25,000 students. Any deviation from this purpose is a misallocation of funds, and a dangerous distraction. The professionals who are hired to produce this work obviously follow suit by adopting this isolated focus upon the stated demands of the project. Unlike the residents of extra-legal settlements, the architect, planner and engineer rarely think about how the means to provide water might be redesigned so as to also provide shelter or food. Not only are such ponderings a waste of time, at least as defined by the call offered by those paying for the work, but it will generally create inefficiencies in meeting the project's primary purpose. To adopt a water-provision system in order to provide shelter will invariably shift resources away from water-based goals toward ambitions outside the project. Thus, it is left to the community to impose these uses upon the offered system by living under bridges or using water pipes as sidewalks.

The business landscape is defined using a similar approach. At the start of any innovation - from the printing press to block-chain technology - thousands upon thousands of businesses rush in to capitalize upon the opportunities thereby created. Many more businesses emerge than can possibly be supported by the opportunities inspiring their formation. This creates an intense competition wherein those businesses with a sound strategy thrive and those without, fail. As this process repeats itself over time, more and more businesses fail. Those which are left, in an attempt to gain

advantage, merge with other promising businesses. This not only eliminates competition, but also allows for businesses to address some of their weaknesses by acquiring assets that offer strength in this area. This cycle gradually slows as the landscape of competition is winnowed down to only a few winners, each of which is equipped to take full advantage of the opportunities offered by the new technology. It is important to note that this process only works well when two conditions are met. First, each of the business entities must be driven to utilize all of their resources to gain supremacy within the new landscape, and committed to engage in this competition until the end. Second, each of the businesses must operate independently, and from a position of knowledge. This ensures that they are making well-informed decisions in the best interest of their innate goals and then pursuing their specific agenda with abandon. Those adept at this process – constantly striving to possess the most important information, the smartest strategies or the best practices – will inevitably consume those without this drive (Surowiecki, 2005).

3.0 CONCLUSION

Translating this strategy, and those earlier described, to the design of extra-legal settlements creates a design process that starts with the implementation of many small-scale innovations, each of which is based upon the ideological and material infrastructure of the community. Thus grounded, the most useful innovations, as determined by the value structure of the community, will naturally propagate. As the landscape is thus winnowed down, the remaining ideas will merge together, creating the large-scale, hybridized address required to realize a more sustainable settlement. Understanding this process, and refining the engagement of it, represents a critically important task for the design professional and a potent research agenda. If successful in this regard, not only will the design of both legal and extra-legal settlements be improved, but the manner in which the design professional offers their insights will become much more articulate. Over time, new processes will emerge and new measures for success, adopted. This will create a more sophisticated infrastructure for design intervention, allowing architects, planners and other professionals to offer work that is naturally equipped to thrive within the unique rigors of all settlements and to propagate healthier, safer and more sustainable environments for everyone.

4.0 SOURCE MATERIAL

4.1 References

- Addis, Noah. 2012. *Future Cities*. Obtained from Rosenberg, David. 2013. "Epic Shanty Towns From Around the World." *Slate*, July 10, 2013 Slate. <https://slate.com/culture/2013/07/noah-addis-future-cities-looks-at-squatter-communities-around-the-world-photos.html>
- Anand, Shefali, and Gabriele Parussini. 2017. "Mumbai's Slums Make Way for Luxury Residential Towers." *The Wall Street Journal*, January 24, 2017. <https://www.wsj.com/articles/mumbais-slums-make-way-for-luxury-residential-towers-1485259208>.
- Crawford, Margaret. 1991. *Can Architects Be Socially Responsible?* in *Out of Site: A Social Criticism of Architecture*, edited by Diane Ghirardo, 27-45. Seattle, WA: Bay Press.
- Davis, Mike. 2006. *Planet of Slums*. New York, NY: Verso.
- Florida, Richard. 2014. "The Amazing Endurance of Slums." *Bloomberg CityLab*, January 23, 2014. <https://www.bloomberg.com/news/articles/2014-01-23/the-amazing-endurance-of-slums>:
- Freire, Paulo. 2010. *Pedagogy of the Oppressed*. New York, NY: Continuum International Publishing Group.
- Gray, Leslie. 2011. "Gamers Succeed Where Scientists Fail." *UW News*, Sept 19, 2011. <https://www.washington.edu/news/2011/09/19/gamers-succeed-where-scientists-fail/>
- Habitat for Humanity. 2018. "Urbanisation and the Rise of Slum Housing." Habitat for Humanity, 2018. <https://www.habitatforhumanity.org.uk/blog/2018/09/urbanisation-slum-housing/>
- International Design Clinic. 2021. "What We've Done." <http://www.internationaldesignclinic.org/what-weve-done>
- Majola, Nokulunga. 2020. "Durban Residents Rebuild Shacks After Demolition During Lockdown." *GroundUp by News24*, 11 April 2020. <https://www.news24.com/news24/southafrica/news/durban-residents-rebuild-shacks-after-demolition-during-lockdown-20200411>
- Malhotra, Ashish. 2018. "Devastated and Destroyed: Delhi Slums Struggle to Recover from Frequent Fires." *The Guardian*, September 5, 2018. <https://www.theguardian.com/cities/2018/sep/05/devastated-destroyed-delhi-slums-recover-fires>
- Marx, Benjamin, Thomas Stoker and Tavneet Suri. 2013. "The Economics of Slums in the Developing World." *Journal of Economic Perspectives*, Vol. 27, No. 4: 187-210. <https://www.aeaweb.org/articles?id=10.1257/jep.27.4.187>
- Miller, Johnny. 2018. "Unequal Scenes" <https://unequalscenes.com>
- Nianias, Helen. 2016. "Four Myths About Slums: 'Don't Assume People Want to Leave.'" *The Guardian*, September 28, 2016. <https://www.theguardian.com/global-development-professionals-network/2016/sep/28/four-myths-about-slums-dont-assume-people-want-to-leave>
- Global Change Data Lab. 2018. "Urban and Rural Population 2050." *Our World in Data*. https://ourworldindata.org/grapher/urban-and-rural-population-2050?country=~OWID_WRL
- Shall, Scott. 2021. "Online Bricollage: Toward an Architecture of Scavenged Means, Improvisational Methods, and Decentralized Processes." In *Performative Environments: ARCC 2021 International Conference*, edited by Chris Jarrett and Adil Sharag-Eldin, 337-344. Washington D.C., USA: Architectural Research Centers Consortium, Inc ISBN: 978-1-935129-30-1.
- Sorensen, Juliet. 2016. "Lagos is Burning." *US News and World Report*, December 2, 2016. <https://www.usnews.com/opinion/world-report/articles/2016-12-02/nigerias-government-is-destroying-lagos-slums-and-undermining-its-own-aims>
- Stevens, Garry. 1998. *The Favored Circle: The Social Foundations of Architectural Distinction*. Cambridge: MIT Press.
- Surowiecki, James. 2005. *The Wisdom of Crowds*. New York, NY: Anchor Books.
- Thieme, T., & Eszter K. 2015. "Services and Slums: Rethinking Infrastructure and Provisioning Across Nexus." *Economic and Social Research Council*. https://www.researchgate.net/publication/279174398_Services_and_Slums
- University of Chicago and Mansueto for Urban Innovation Research Computing Center. 2020. "Million Neighborhoods." <https://millionneighborhoods.org/#11.48/-4.4124/15.3476>

- UN-Habitat. 2003, updated 2010. "The Challenge of Slums – Global Report on Human Settlements." *United Nations Human Settlements Programme*. <https://unhabitat.org/the-challenge-of-slums-global-report-on-human-settlements-2003>
- UN-Habitat. 2015. Streets as Public Spaces and Drivers of Urban Prosperity. *Habitat III: Issue Papers, 22 – Informal Settlements*. <https://unhabitat.org/streets-as-public-spaces-and-drivers-of-urban-prosperity>
- United Nations Statistics Division. 2019. "Sustainable Cities and Communities." *2019 Report*. <https://unstats.un.org/sdgs/report/2019/goal-11/>
- WatchScroll. 2018. "Mahul, Mumbai's Rehabilitation Hellhole." *YouTube*, 15 March 2018, https://www.youtube.com/watch?v=pRXW-fio1_o&t=114s.
- World Health Organization. 2000. *Informal Settlement Report*. <http://www.who.int/ceh/indicators/informalsettlements.pdf>

4.2 Endnotes

¹ Often wrongly referred to as informal, or offensively termed slum, the term *extra-legal* is derived from the definition for informal settlement offered by the UN-Habitat Programme, which is arguably the definition most widely applicable, includes only two primary characteristics: informal settlements are illegally located and they are illegally constructed. It naturally follows that, these settlements might be best referred to as *extra-legal* (UN-Habitat, 2105, 3).

² From <https://unstats.un.org/sdgs/report/2019/goal-11/> The absolute number of people living in slums or informal settlements grew to over 1 billion, with 80 per cent attributed to three regions: Eastern and South- Eastern Asia (370 million), sub-Saharan Africa (238 million) and Central and Southern Asia (227 million). An estimated 3 billion people will require adequate and affordable housing by 2030 (Nianias, 2016).

³ In 2009, the Indian government proposed the creation of an urban investment strategy in order to create a "slum-free India" in five years. In 2011, while this remarkable housing plan was still very much in development, a study revealed that not only would these efforts not eliminate slums within the country, but it would cause them to grow, as the proposed improvements would increase the pace of in-migration to the renovated communities, causing overcrowding and the eventual deterioration of the conditions the program set out to improve (Marx, Benjamin and Stoker, Thomas and Suri, Tavneet, 2013). Also (Florida, Richard, 2014).

⁴ "The implication has been that informal economic activities and by extension informal provision of goods and services were not only described as irregular, casual and potential precarious, but also outside the remit of state regulation and surveillance. Therefore, as urban slums are characterized by informality in all spheres of life, they become to an extent invisible to the state, especially in terms of public provisions" (Thieme & Kovacs, 2015, 18).

⁵ "Particularly when it comes to basic service provision, a form of 'malevolent urbanism' has generated across urban areas in the global South, where unequal access to and use of the city is prevalent. At the same time, a mosaic of actors, sectors, and initiatives seek to address the 'challenges of slums', usually purporting to work *with* local communities, but often misunderstanding how everyday practices and expectations might differ from externally defined development goals and impact measures (Thieme & Kovacs, 2015, 1).

⁶ Thieme and Kovacs urge those attempting to positively impact the conditions found within slums to reverse the "flows of knowledge and expertise so as to theorize the nexus from the slum, where inhabitants experience everyday relationships to water, food, energy and waste as integrated." (Thieme & Kovacs, 2015, p. 15). The term *authentic dialogue* is borrowed from Paulo Freire (Freire, 2010).

⁷ "It happens, however, that as they cease to be exploiters or indifferent spectators or simply the heirs of exploitation and move to the side of the exploited, they almost always bring with them the marks of their origin: their prejudices and their deformations, which include a lack of confidence in the people's ability to think, to want, and to know. Accordingly, these adherents to the people's cause will constantly run the risk of falling into a type of generosity as malefic as that of the oppressors. ... They talk about the people, but they do not trust them; and trusting the people is the indispensable precondition for revolutionary change." (Freire, 2010, 60).

⁸ "The 'bricoleur' is adept at performing a large number of diverse tasks; but, unlike the engineer, he does not subordinate each of them to the availability of raw materials and tools conceived and procured for the purpose of the project. His universe of instruments is closed and the rules of his game are always to make do with 'whatever is at hand', that is to say with a set of tools and materials which is always finite and is also heterogeneous because what it contains bears no relation to the current project, or indeed any particular project, but is the contingent result of all the occasions there have been to renew or enrich the stock or to maintain it with the remains of previous constructions or destructions. ... It is to be defined only by its potential use or, putting this another way and in the language of the 'bricoleur' himself, because elements are collected or retained on the principle that 'they may always come in handy'" (Levi-Strauss, 1968, 17-8).

⁹ "The practice of approaching services' in an individualized, technocratic form highly reliant upon engineering solutions and expert knowledge reflects institutional and management overlaps and incoherencies between sectors that are not required or in the habit of communicating, whether across governmental ministries, departments or donors, and indeed, is valid across the services' spectrum, whether for waste, water, food or energy. ... Approaches to municipal water tend to be fairly technocratic in provision and analysis, ignoring the overlapping effects of waste on water, sanitation, food and health, with emphasis on the lack of political will and finances for operationalizing an effective waste management system, but one that does not explicitly address these interdependencies." (Thieme & Kovacs, 2015, 8-9).

Indeterminate Space

Peter Wong¹

¹University of North Carolina at Charlotte, Charlotte, NC

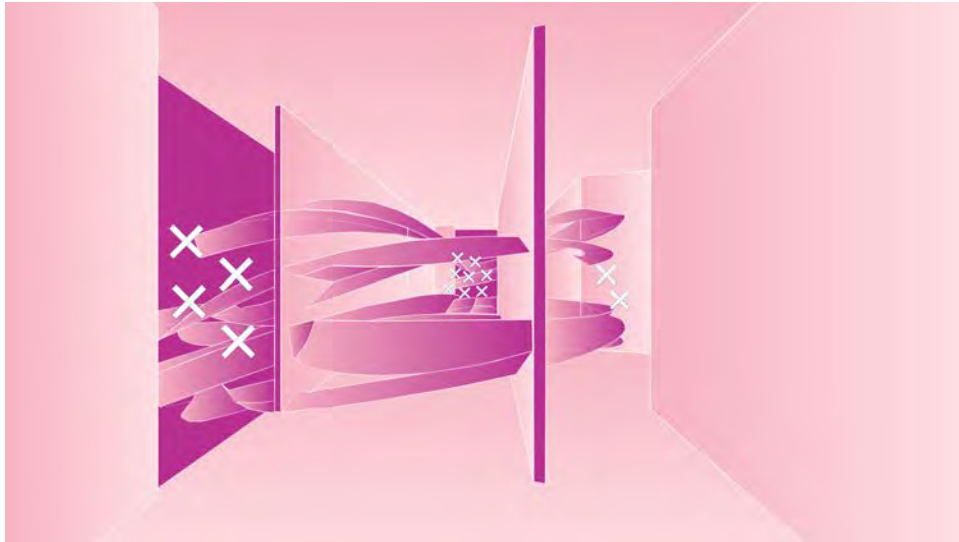

ABSTRACT: The perception of architectural space involves a visual understanding of objects, light, color, and depth. This research and design study examines how architectural viewers of two-dimensional scenes focus their attention on such elements with the aid of eye-tracking hardware and software. Research results revealed patterns in how viewers observe interior spatial scenes, with special attention given to apertures and edges leading to regions outside the immediate space. These results did not vary significantly between historic or modern spaces, nor did the chromatic qualities of the scene display large participant differences in the experiment. The paper concludes with a set of design investigations gleaned from the findings of the eye-tracking experiment. These are generated with an architectural syntax derived from the perceptual research segment of the study. This segment of the study attempts to find out what degrees of interest are given to different aperture types that lead our gaze out and beyond the space. The application of such design-research aims to open a dialogue concerning dwelling spaces, specifically those involving micro-habitats in dense urban conditions.

KEYWORDS: Eye-tracking, space, perception

INTRODUCTION

Next to the vertical line, whose living bearers resolve space by our bodily orientation into above and below, front and back, left and right, the most important direction for the actual spatial construct is the direction of free movement – that is, forward – and that of our vision, which, with the placement and positioning of our eyes, defines the dimension of depth.¹

August Schmarsow, 1893

Architectural space, since the development of 20th century modern architecture, has received a generous share of discussion, research, practice, and scholarship. From Bruno Zevi's claim on the fourth dimension of space in architecture, where bodies move about volumes and time in ways that distinguish it from the other visual arts, to Luigi Moretti's pre-war writings concerning the autonomy of a spatial vocabulary that places space in the realm of dynamic action, pressures, and sequences, the notion of space has endured many interpretations.

With the introduction of computational models and tools, a renewed definition and set of parameters for architectural space has emerged in perception and cognitive studies that seek to better understand how volumes defined by

normative architectural elements are recognized in our field of view. This paper describes a related experiment with human participants using eye-tracking techniques now readily available to designers. It then uses the results to propose various types of interior space that will be recursively used in designing interior with the hopes of yielding similar results and data. The first part of this research focused on *how viewers perceive architectural space given two-dimensional representations of interior rooms*. The second part of the study aimed to *utilize the results of the experiment to guide design activities* as a demonstration project.



Experiment image types: left: image 2 (historic color); center: image 9 (historic black and white), right: image 12 (modern black and white).

Figure 1: Image types viewed for Part 1 of the study (left to right): historic color, historic black and white, and modern. Source: (Author 2021).

Researchers observed how objects, elements, and/or visual phenomena functioned as stimuli in an architectural scene. Included in this field of view were objects (people, furniture, equipment, decorations, etc.) as well as the subject of architecture itself: walls, floors, stairs, apertures, and ceilings. In addition to these spatial constituents, the study was designed to see if the style or character of architecture might also contribute to the way spaces were perceived. To study this, historic European spatial interiors were used next to more modern renditions of space.

BACKGROUND

This study follows modern trends in the definition of architectural space. Space as a construct is rooted in 19th century German aesthetics built upon Kant's ideas of human anatomy and experience as the basis for moral and scientific understanding.² This era of discourse supports a view of form and space that places humans at the center of an empirical world where reason and judgement capture how we appreciate and take delight in the aspects of our environment. These ideas become instrumental in the visual arts, and in design disciplines where the human body participates with objects and surroundings via perceptual and physical means.

Much of architectural education and training has inherited ideas from these early 19th and 20th century movements, and architects continue to train in and practice the discipline according to these principles. This paper focuses on two of the resulting sub-discourses: space defined as physical determinants and as a perceptual realm.³ As a physical manifestation, the notion of space relies on the dimensional and geometric attributes of **form** in architecture. Shape, form, syntax, and dimensional attributes become factors for space when it is considered as a container or vessel for buildings and structures. The parameters of space in this definition comprise all three dimensions and also included the factor of time.⁴ Space can also be **perceptual**, when considered as a human psychological experience related to principles that underscore visual phenomena and thus guide empirical observation and recognition. In this definition, the human means for perceiving space is a factor of distance, perspective, and the relation and interaction between objects in the field of view as suggested by Anton Ehrenzweig.⁵ This *Gestalt* experience of space defines our modern paradigm of architecture and symbolizes the development of spatial realms that align with German aesthetic practice and French phenomenological positions.

PART 1: EYE-TRACKING – VISUAL ATTENTION AND REPRESENTATION

Eye tracking systems measure eye position, eye movement and pupil size to define the direction and duration of a person's gaze.⁶ Since the 1970s there has been an increase in the use of eye-tracking applications, often driven by research in advertising, marketing, psychology, neuroscience, design cognition, and user interface design

Early research into visual attention based on eye movement was conducted by Buswell, who focused on the aesthetic impact of photographs of artwork, patterns and sculpture, particularly the layout patterns of advertisements.⁷ Kaufman and Richard measured eye fixation times in several pre-defined elements of a scene, and identified that the center of gravity in a scene is an attractor as well as edges and corners.⁸ Torralba, Oliva, Castelhana, and Henderson proposed visual attentional guidance through an experimental search task.⁹

Research and analyses on how representation is important to viewing architectural design has been explored by Park, Jin, Ahn, and Lee using eye-tracking technology with the use of photographs and line drawings.¹⁰ This study involved eye-tracking data collected from participants viewing six pairs of photographs and line drawings and analyzed how representations affect people's perceptions of architectural scenes. While the relationship between eye movement and perception of visual scene representation has been investigated, there has been little research on the role of eye movement in the study of three-dimensional architectural space. This study investigates viewer responses to two-dimensional representations of three-dimensional space. A key objective was to explore in more detail the attention viewers paid to 'empty space' or 'spaces beyond' in contrast to objects. The study used color and black and white scenes, as well as different styles of architecture. The experiment utilized a screen-based method that used *Tobii Studio*® and *GazePoint*® infrared light eye-tracking hardware and software in controlled environments. The study also made use of the visual attention simulation (VAS) software developed by the 3M Company that sets parameters which simulate the way viewers inspect static pictures.

RESEARCH QUESTIONS

As fundamental to the research, a series of questions were developed to guide the study:

Inquiry 1. Do participants' visual attention show significant differences between the types of images (historic vs modern, color vs black and white)?

Inquiry 2. Do participants' visual attention show significant preferences between the types of space vs. objects in the images?

Inquiry 3. Does the eye-tracking analysis of high fixation areas generated by the visual attention simulation software (VAS) differ from the high fixation areas of participants when viewing architectural space?

Inquiry 4. Do participants show similarities in the order in which they view high fixation areas?

Inquiry 5. Do participants' visual attention show significant differences when images are presented in a different order?

DESIGN OF THE EXPERIMENT

A convenience sample of 75 first and second year undergraduate architectural students at the University of North Carolina Charlotte participated in the experiment. The students were divided into three groups with 25 students in each group. Each group of students was asked to view three types of images in different orders (Figure 1). The experiment was set up to track two different spatial conditions. The first involved historic architecture portrayed in 17th century paintings of Dutch houses by the painter Pieter de Hooch (1629-1684). Painted in the tradition of the Dutch Golden Age of artists, de Hooch's works depict domestic interiors. The scenes are unique in that they are presented as one-point perspective spaces in color that demonstrate the common conditions of life during the times. These interiors display a strong sense of enclosed space with doorways, windows, and contrasting light conditions that enable a view of the environs beyond. For the purposes of the experiment, these traditional spaces can be defined as historic room-like interiors with walls and apertures portrayed as typical of subdivided architectural interiors.

The second set of images were defined as "modern" interiors, as seen through the cameras of mid-20th century photographers. These included 1950s and 60s house projects by Richard Neutra. The photographs were presented in black and white, as one-point perspectives with rich spatial interiors. These interiors, like the traditional spaces of de Hooch, feature spaces beyond the immediate environs of the scene. The primary difference is that spaces beyond the room are separated by planes and surfaces that often exclude the typical doorway and window treatment of traditional interior spaces. To examine possible influences of color, select scenes from the traditional set of images were rendered in black and white. Human figures were removed from the scenes in all images.

The experiment asked individuals to view one of three sets of sequenced images with 25 architectural students in their first years of study viewing each set. Each set comprised 15 images, with each image viewable for 10 seconds. Each set had five historic color interiors, five historic black and white interiors, and five modern black and white interiors. The experiment included a questionnaire that obtained each participant's sex, age, ethnic group, and knowledge or training at viewing art and visual representations. The three sets are summarized below (Figure 2):

Set 1: five historic/color, five historic/b&w, and five modern/b&w.

Set 2: five modern/b&w, five historic/b&w, and five historic/color.

Set 3: a random arrangement of the three image types.

The critical data measurements in eye-tracking research included: area of interest (AOI), defined as an area that receives the most attention by observers, view to first fixation, the time spent at a particular location(s) of the scene,

and the saccades or the movements and locations of the eye with the scene. This study identified three types of AOIs: 1) AOIs identified by the VAS software simulation 2) semantic AOIs, defined by the spaces/objects in the images, and 3) high fixation AOIs. Six types of eye movement were measured: 1) number of viewers, 2) average time to first view (secs), 3) average time viewed (secs), 4) average number of fixations, 5) number of revisitors, and 6) average number of revisits. The 3M VAS software employed is a program analysis that tracks image brightness or color contrasts and generates a visual heat map of potential AOIs. In contrast to the computer generated AOIs of the VAS software, the experiment results were used to define five new types of semantic AOIs: foreground objects, ceilings, floors, openings with space beyond, and openings with brightness.



Figure 2: Experiment viewing sets combining historical and modern interiors. Source: (Author 2021).

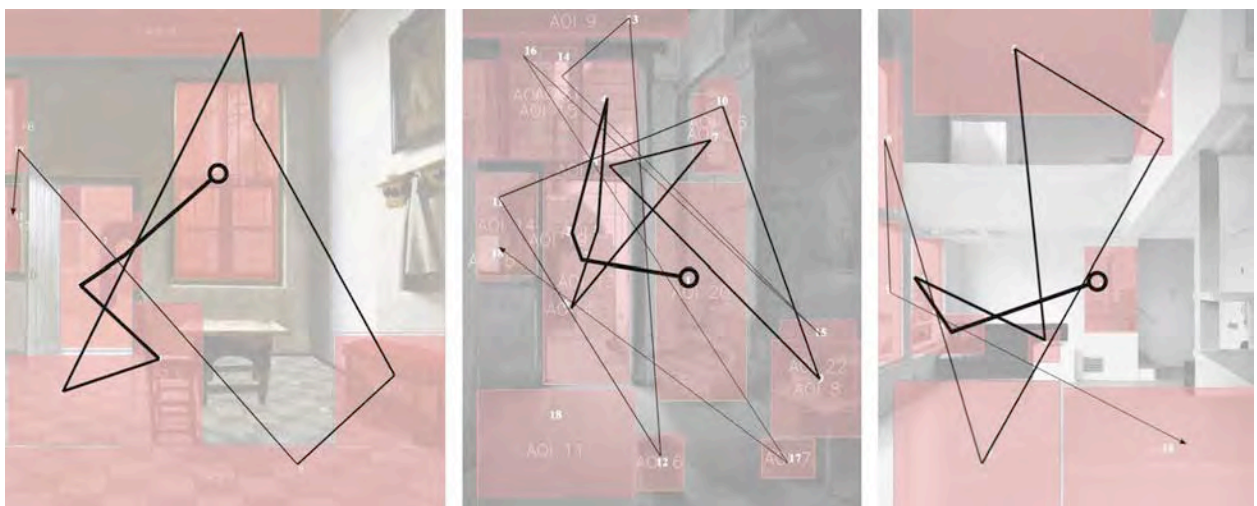

Figure 3: Eye saccades from the three types of images. Source: (Author 2021).

RESULTS

The experiment resulted in a rich set of data that answer the research questions and produced several intriguing observations.

Historic vs. Modern Interior Scenes: There were no significant differences found between the three types of images (Figure 3). This indicates that the representational style and the type of architectural scene (historic or modern) were not primary factors that affected participants' visual attention.

Visual Attention: In terms of the five semantic AOIs, openings with spaces beyond received fastest (first view) and longest attention. Foreground objects came second. Floors received the fewest fixations. This suggests that viewers sought out areas of the scene beyond the immediate interior limits of the space. It also raises questions about our attention preference for voids vs. objects in an architectural scene.

VAS Simulation Data vs. Participant Data: The results of the VAS computer simulations differed significantly from the participant data gathered from the experiment. VAS is set up to recognize objects, faces, color and light differences. Since the software depends heavily on the brightness of areas in an image, which is more varied and diverse in the spatial scenes used in the study, this suggests VAS is not a viable model for simulating how humans view interior realms.

Sequence and Position of The Gaze within a Scene: Participants tended to look at the center of images first and scan to the left of the images followed by other areas (Figure 3). This shows results similar to a larger body of research, including a Yu and Gero study, that suggests designers tend to focus on the middle or left of an interface.¹¹

Order of Images and Visual Attention: Other than AOIs of high fixation, the order in which images were shown to the three groups of participants had a minor impact on participant's visual attention.

Gender Differences: A variety of gender differences were identified, especially in visual attention on foreground objects. This coincides with a previous study by Abdi Sargezeh et al. (2019).¹² Though not part of the original research expectations, these gender difference deserve further study and experimentation.

PART 2: DESIGN RESEARCH

Understanding where individuals look in three-dimensional realms provides valuable insight into how we grasp a sense of space that expands beyond the limits of our surroundings. Of interest is the way we quantify how these spaces, irrespective of their particular architectural style and character, operate in similar ways revealing the means by which eyes perceive visual information. Furthermore, the ways in which we scan environments suggest that design can lead our eyes to other realms of space beyond our immediate environs, dependent on how we position apertures, create visual contrasts and relief, and locate objects in space.

The second part of the research was extrapolated in the architectural design process. This corollary step of the research led to more speculative work that drew upon the analytical nature of the first phase. This synthesis of information led to a set of design parameters that were based on understanding that our visual attention seeks areas of a scene that suggest spaces and environs beyond the immediate space of a room. By analyzing the data and isolating elements of the scene, two forms of architectural vocabulary were identified and used in a design demonstration project.

Frames for Space: Given the results of the eye-tracking analysis it was found that AOIs and eye movements were concentrated around framing elements of the interior spaces viewed, as seen clearly in the data gather from the historic images. Using the results from the experiment, a glossary of types were developed for openings and apertures leading to spaces beyond the immediate view of the room. These include: 1) "punched openings" (po), 2) "edge openings" (eo), 3) curtain wall (cw-1) full wall opening opposite of the viewers position, and 4) curtain wall (cw-2)full wall opening adjacent and parallel to the viewers position (Figure 4).

Punched openings are familiar to us as holes in exterior walls to allow light and air. The common picture window or "ready-made" contractor window product is an example of such. Edge openings are when cuts in the wall and/or ceiling move across two perpendicular surfaces – the iconic "corner window" condition is an example of this. Window wall characteristics are openings that substitute opaque wall surfaces for transparent material, so that the edges of floor, wall, and/or ceilings coincide with the opening limits.

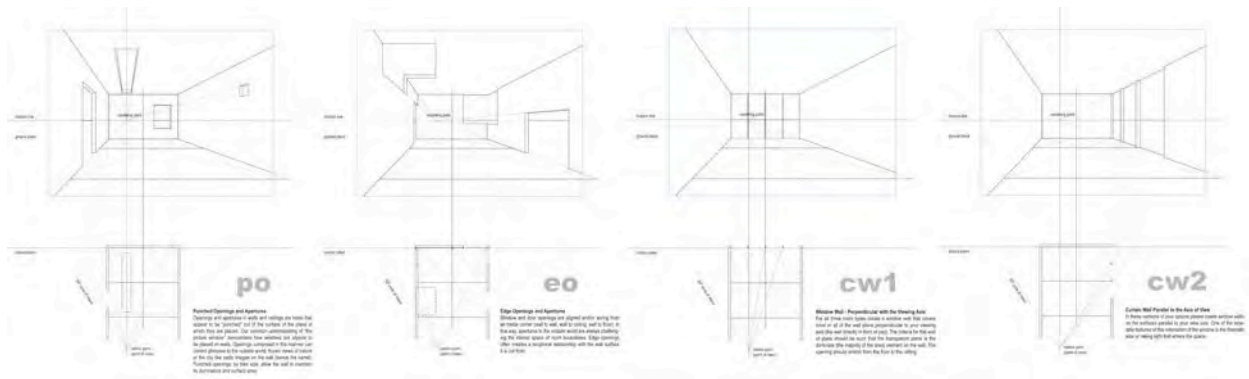

Figure 4: Four eye-aperture types (left to right): punched opening, edge opening, opposing curtain wall, adjacent curtain wall. Source: (Author 2021).

The Edges of Space: Along with the four kinds of apertures, designers take into consideration the elements that make up the larger dimensional aspects of the space. The architectural vocabulary to shape space and bear the weight of the building include walls and columns. There is also the need to span horizontal dimensions below our feet as well as above (ceilings and canopies) to allow for activities and protection. Adhering to modernist principles of making spaces, the experiment exposed the importance of edge conditions that separate near and distant realms where such basic architectural elements play a role. Moreover, these elements, such as planar walls/screens and hovering floor and ceiling edges, function to enable the eye to distinguish between the subdivision and extension of spatial areas that are complemented by framed apertures.

These edge and line conditions permit spaces to be sensed beyond the immediate plane of perception by occluding and hiding or eyes from the view of the areas behind. Examples of “first-person shooter” games provide a clear example of this, where the next narrative episode of play takes us around corners, over edges, or out behind protective screens as the player wayfinds rooms and passages to the next encounter.¹³

Three conditions of edges and planar manipulation were taken from the modern examples in the participant study. Much of this vocabulary has been in practice since the early 20th century and serves as a way for isolating their spatial effects. These elements are object like, but they also are screens place so that “out-of-view” spaces or spaces that are concealed or hidden lie just beyond our field of view. The first of these include walls or planes that divide or sever space into smaller zones (oov-w). The second and third out-of-view configurations occur on the horizontal, where floors (oov-f) and/or ceilings (oov-c) are cut way revealing spaces below or above (Figure 5).

Though we often witness the last two out-of-view conditions as typical double-height spaces, were floors or ceilings are sized according to the dimension of a single story, there are architects such as Adolf Loos who made incremental adjustments to floor and ceiling heights that take also into account the horizontal depth and breadth of a room, in other words Loos was able to better tailor and proportions space with full control over all three spatial dimensions. Spaces designed in this way allow a field of view that forces travel through the arrangement of rooms carrying our eyes (and feet) to other realms. This increases our awareness as spaces dip or ascend away from the level we occupy. Such micro adjustments of floor heights command a high degree of dexterity on the part of the architect as the subtle shifts underfoot imply that floors above and below must be designed in simultaneous fashion to accommodate workable spatial configurations in the building’s section. Loos’s use of the *raumplan* in his domestic architecture is a notable example of this spatial craft.

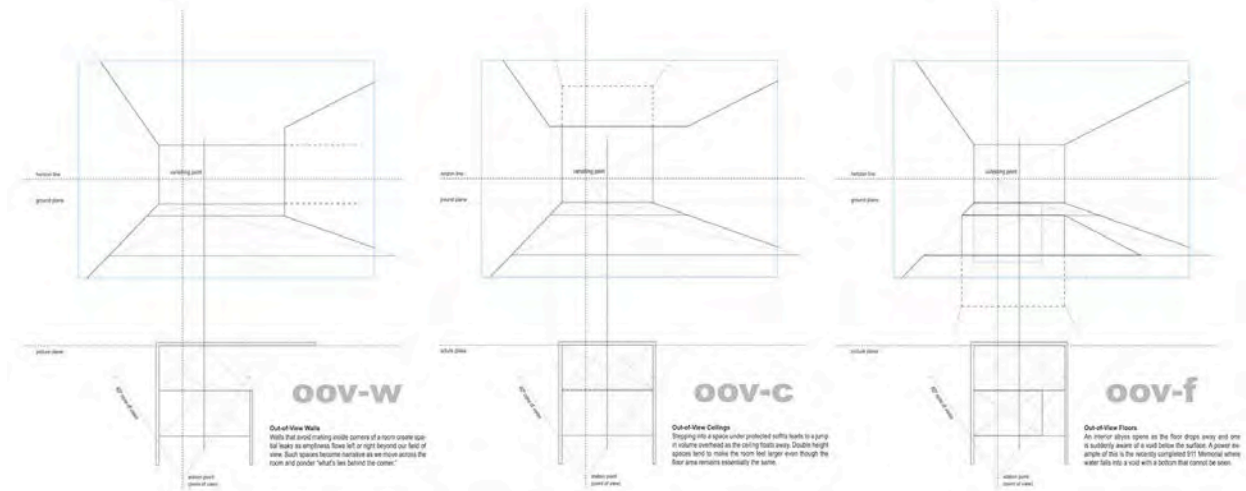

Figure 5: Three types of “out-of-view” qualities of a room (left to right): out-of-view wall, out-of-view ceiling, and out-of-view floor configurations. Source: (Author 2021).

EYES ON DESIGN

As a demonstration project the second part of this study designed four micro-units with the vocabulary of apertures and out-of-view room spatial characteristics outlined above. These were presented to 23 participants and mapped with four eye-tracking parameters in mind. These parameters included: 1) areas of interest (AOI), 2) view to first fixation, 3) saccades, and 4) revisits to one or more previous fixation point. The results of the design, eye-tracking, and diagrams of the results of the experiments were compiled, interpolated, and represented as spatial volumes (Figure 6.).

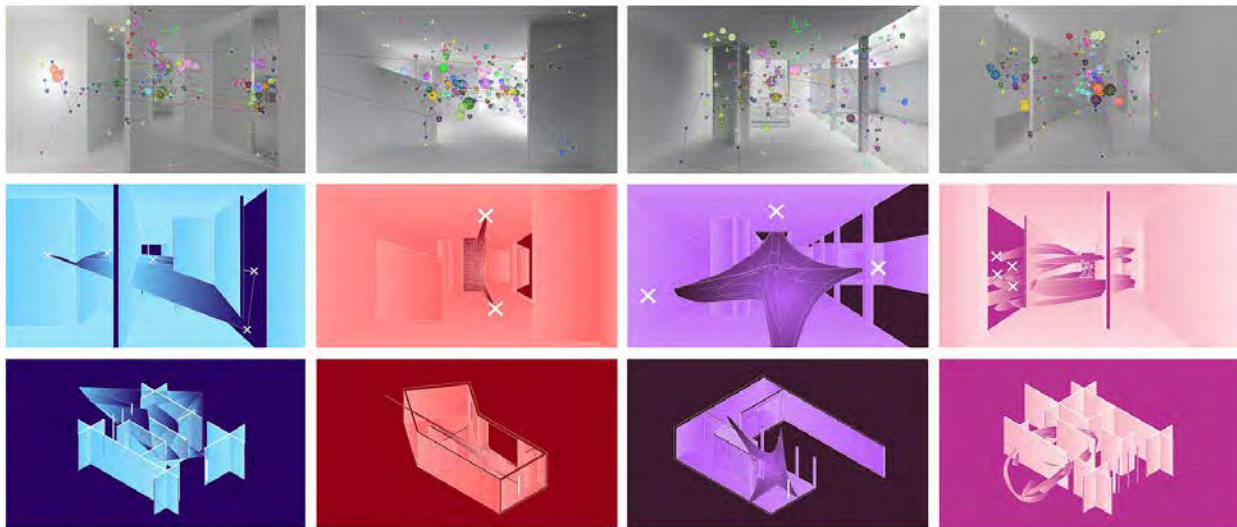
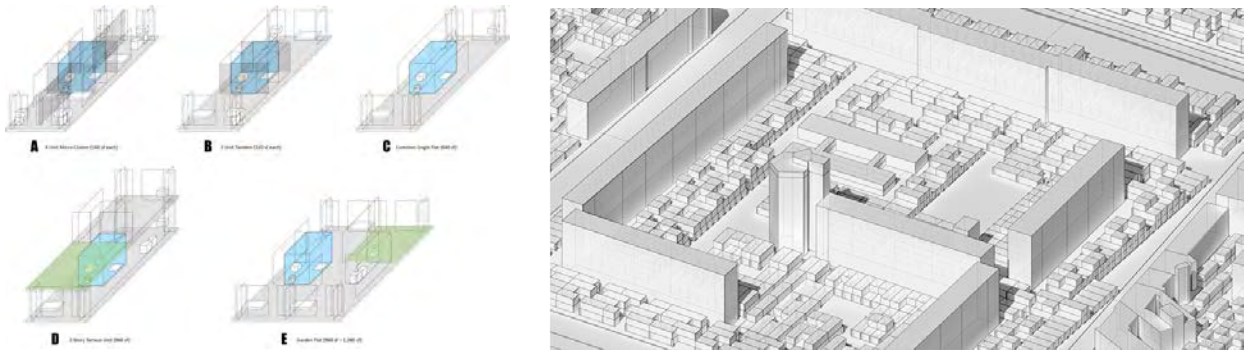

Figure 6: Four eye-tracking characteristics as taken from 23 participants viewing four spaces (left to right): AOI, View to First Fixation, Saccades, and Revisits. Source: (Author 2021).

These spaces and resulting micro-units were assembled as a demonstration project for an affordable, dense urban social housing project that incorporated timber construction at the feet of 1950 and 60s housing projects in Berlin. The available land left by these Corbusian-inspired blocks served as the site for an increase in density for immigrant and local resident housing needs in the metropolis (Figures 7 and 8).



Figures 7 and 8: Affordable and micro-scale housing demonstration project drawn from the research. The proposal anticipates how open lands surrounding 1950 and 60s social housing in Berlin might be developed. Units are constructed of cross-laminated timber with compact units designed to convey a sense of expanding, indeterminate space. Source: (Author 2021).

FINAL THOUGHTS AND QUESTIONS

Understanding where individuals look in three-dimensional realms provides valuable insight into how we grasp a sense of space that expands the limits of our surroundings. Of interest is the way we might quantify how these spaces, irrespective of their particular architectural style and character, operate in similar ways revealing the means by which eyes perceive visual information with the feeling of an expanding field of view. Furthermore, the ways in which we scan and perceive these environments suggest that design can remain efficient, affordable, and humane given increasing population demands on our urban environments. The study also opens further debate about the design and practice of architecture. As demonstrated in the design research above, could these preliminary findings inform current efforts in architecture to meet the demand for more spatially compact, economical, and equitable living scenarios? Could such research establish ways of producing an architecture that is spatially efficient but with an expanding sense of richness and utility in urban settings of increasing density? To this end, further design-research might incorporate a more precise taxonomy of spatially indeterminate architecture in order to test the resilient nature of living space in the rising tide of expanding urban places.

ACKNOWLEDGEMENTS

The author of this paper would like thank Professors John Gero and Rongrong Yu for their important and significant contributions in part one of this research. Also should be mentioned is the dedicated work by my research assistants Luca Gillie, Jasir Mills, Ben Simmons, and Callie Watson for their efforts with the graphic, representation, and design assistance for the demonstration project shown in part two of this article.

ENDNOTES

- ¹ August Schmarsow, "The Essence of Architectural Creation," *Empathy, Form and Space: Problems in German Aesthetics 1873-1893*, trans. H. F. Mallgrave and E. Ikonomou (Santa Monica: Getty Center, 1994), 289. Essay originally published in German, 1893.
- ² Mallgrave, H. *Empathy, Form and Space: Problems in German Aesthetics 1873-1893*, trans. H. F. Mallgrave and E. Ikonomou (Santa Monica, CA, Getty Center, 1994), 6.
- ³ Norberg-Schulz, C. *Existence, Space & Architecture* (New York, NY, Praeger Publishers, 1971), 12-16.
- ⁴ Zevi, B., *Architecture as Space* (New York, NY, Horizon Press, 1972).
- ⁵ Ehrenzweig, A. *The Hidden Order of Art*, (Berkeley, CA, University of California Press, 1967), 21-31.
- ⁶ Gonzalez-Sanchez, J., Baydogan, M., Chavez-Echeagaray, M. E., Atkinson, R. K., & Burleson, W. "Chapter 11 - Affect Measurement: A Roadmap Through Approaches, Technologies, and Data Analysis," M. Jeon (Ed.), *Emotions and Affect in Human Factors and Human-Computer Interaction* (San Diego: Academic Press, 2017), 255-288.
- ⁷ Buswell, G.T. *How people look at pictures: A study of the psychology of perception in art* (Chicago: University of Chicago Press, 1935).
- ⁸ Kaufman, L., & Richard, W. "Spontaneous fixation tendencies for visual forms," *Perception and Psychophysics*, 5, 1969, 85-88.
- ⁹ Torralba, A., Oliva, A., Castelhamo, M., S., & Henderson, J. M. "Contextual guidance of eye movements and attention in real-world scenes: The role of global features in object search." *Psychological Review*, 113(4), 2006, 766-786.
- ¹⁰ Park, J., Jin, Y., Ahn, S., & Lee, S. "The impact of design representation on visual perception: Comparing eye-tracking data of architectural scenes between photography, line drawing," *Archives of Design Research*, 32(1), 2019, 5-29.
- ¹¹ Yu, R., & Gero, J. S. "Using eye-tracking to study designers' cognitive behaviour when designing with CAAD," P. Rajagopalan (ed), *Engaging Architectural Science: Meeting the Challenges of Higher Density*, Proceedings of the 52nd International Conference of the Architectural Science Association, Melbourne, 2018, 443-45.
- ¹² Abdi Sargezeh, B., Tavakoli, N., & Daliri, M. R. (2019). Gender-based eye movement differences in passive indoor picture viewing: An eye-tracking study. *Physiology & Behavior*, 206: 43-50.
- ¹³ Jenkins, H. (2003). "Game Design as Narrative Architecture." MIT web library access: <https://web.mit.edu/~21fms/People/henry3/games&narrative.html>.

Drawing Memories: Mapping as Part of Oral History

Gray Read¹

¹Florida International University, Miami, FL

ABSTRACT: As Rosa described the family farm in Guatemala, architecture student Antonio Comas drew a map, following her verbal pictures. Her memories were vivid and warm, recalling the life she was obliged to leave in order to find work in agriculture in South Florida. The drawings showed the layout of the farm superimposed with images of the house, the room where she slept as a child, the goats she tended and the mountains nearby. The drawings helped her to recall more fully the places she knew, and therefore the people and events, as if the landscape held the stories within it. Accuracy was not the goal, rather the drawing abandoned scale, combining map and image to envision the place and its experiences as Rosa remembered them. The conversations were part of an interdisciplinary class that brought Architecture students into teams with English literature majors to collect oral histories of immigration and climate justice. We worked with a local non-profit organization, WeCount! and spoke with agricultural workers from Mexico and Central America, who had left their drought-stricken countries, only to face other climate-change exacerbated risks in South Florida agriculture, such as heat stress. Their stories of loss and resilience help to strengthen the bonds of our collective, urban community. The class developed memory mapping as a technique that opened a spatial point of view in counterpoint to linear narrative. The maps sought to record memories of experience anchored spatially, rather than constructed as narrative in time. They show a field of relationships between people, places, and events simultaneously alive in memory, and often revealed the warm, human connection with home. That emotional connection to a landscape makes the harsh reality of immigration yet more poignant, yet is also the anchor of resilience.

KEYWORDS: Mapping, Oral History, Social Justice



Figure 1. Antonio Comas' drawings from Rosa's memories of the ranch where she grew up in Guatemala including plan of house she described.

1. INTRODUCTION

As Rosa described the ranch in Guatemala where she grew up, architecture student Antonio Comas drew an image that she conjured in his mind (Figure 1). The house with an outside kitchen, the sheep she played with, the waterfall nearby and the soccer field behind the school helped Rosa to recall the life she had lived as a child, and all that she was compelled to leave behind when she migrated to South Florida. Rosa's memories attached to a place in all its detail. They were warm, extending to family, friends, the animals she tended, as well as the rhythms of rural life. Antonio Comas' drawing called on his own memories as much as hers to construct a map of impressions, without scale or a particular story line. The drawing contains many stories, some of which are noted in superimposed text, "as soon as the rain started, flowers of every color started to grow," as if the drawing gives rise to narrative. The drawing of her place of memory serves as a counterpoint to the narrative Rosa told of leaving her home and her country order to earn money working in South Florida agriculture. This narrative runs fairly straight from past to present, and from cause to effect. The drawing, on the other hand, with its multiple images, scale inconsistencies, and notes contains many small stories, often of habitual activities that repeat in time and run simultaneously with each other. The interplay between map and narrative ran at the heart of an interdisciplinary, community-outreach course at Florida International University.

The course was created as part of a project on environmental justice organized by the Humanities Action Lab (HAL), an NEH-funded center based at Rutgers University in Newark, NJ (<https://www.humanitiesactionlab.org/>). My colleague in the English Department, Martha Schoolman and I developed a local project to invite our students see and feel some of the experiences and challenges of people in our own community. We worked with WeCount!, a local education and advocacy group of workers in Homestead, an agricultural community south of Miami. We took an interdisciplinary group of students (Architecture and English) to talk with agricultural workers who had immigrated to South Florida from Central America and Mexico. The participants in our project, such as Rosa, met with our students twice over shared dinners and offered their stories of life in their countries, the threats they faced that drove them to immigrate, their journey to the US, and some of the details of their current working situation. In conversation, our students gathered these oral history narratives and drew maps based on participants' descriptions of their day-to-day experience growing up in their hometowns. The students then translated the narratives from Spanish to English, edited them into stories, developed the drawings, and produced a website for WeCount! to use in getting their message out to a larger audience.

Our work was one of 22 studies conducted by students at universities across the US and internationally, which participated in the Humanities Action Lab project on climate change and immigration. Each university group collaborated with a local community organization to teach a course in which students engage issues of environmental justice that affect their cities and talk with community members. Students produce material, often oral histories with research documenting the issues, and contribute to the exhibition that then travels to the participating universities.

Our community partner, WeCount! assists and represents agricultural workers in Homestead, most of whom immigrated from Central America and Mexico. Some are US citizens, some hold green cards or work visas, some have Temporary Protected Status, and some arrived without documentation. This working community of immigrants is now struggling in a repressive political climate in which the local police are legally required to coordinate with immigration agents. WeCount! advocates at state and national levels for immigrant rights and protections for agricultural workers facing increasing heat stress and pesticide exposure.

The goals of our project, as many community-based projects, were to introduce our students to others who have had very different experiences in their lives, and to find a way to make the students' work useful to those we engaged. At a larger scale the project framed resilience as an issue of building community, strengthening the bonds that tie a community together and that bond them to the land they call home. In a community of immigrants, recognizing the nostalgic pull of diverse home countries often ironically helps to bring people together and forge new sentiments for an adopted homeland. A large percentage of students at Florida International University come from Latin American families that speak Spanish at home, therefore while my colleague and I struggled to speak with WeCount! participants in Spanish, they were completely at ease. Some of our students had emigrated themselves, for example from Columbia, Venezuela, and Cuba, while others were first-generation Americans, and of course some had other backgrounds entirely. For many, the immigrant experience was familiar. Through the stories they shared the sentiments of distant childhood memories, of alienation, and of building a life in new territory. Through stories they also recognized the threats that they now face together in Miami as a community and as a landscape.

In the class, interdisciplinary teams worked together. Architecture students were introduced to issues of identity, voice, social position, and point of view in narrative. While students in Literature were introduced to visual storytelling. In the preliminary exercises leading up to our engagement with WeCount!, all of the students drew maps and all wrote and edited text. We had a series of readings that ranged from Rob Nixon's *Slow Violence and the Environmentalism of the Poor* to poet/anthropologist Ruth Behar's *Translated Woman*, an oral history of a Mexican market woman. We also studied the current environmental and political situation in Central America, in particular the endemic drought across the region that is impoverishing farmers, fueling violence, and driving families north. We learned with the students how to do oral history – how to be transparent with participants about your goals and the rules of the game. How to establish

a relationship in two-way conversation in which you offer something of yourself, your own history and experience, and in our case, risk making drawings on the spot. The drawings helped to spatialize the narratives and link them to a specific physical place, both human and geographic.

2. MEMORY MAPPING

The part of this project I focus on here is memory mapping, a kind of spatial sketching, unbound by scale or accuracy. Memory maps freely combine plan and view and often have notes attached (figure 2). More vividly remembered places are drawn larger, even to the details, while less important spaces shrink. People are sometimes drawn in, but often not. As part of the preliminary exercises, students drew their own memory maps of the places and people they remembered from their childhood hometown. They then interviewed a family member or friend and drew their maps. Of course, drawing one's own memory map is truer to personal experience, but drawing someone else's is an exercise in communication. Images emerge from both the description and the imagination of the drawer. When students met the WeCount! participants, they could offer their own maps as a personal way to introduce themselves and the project.

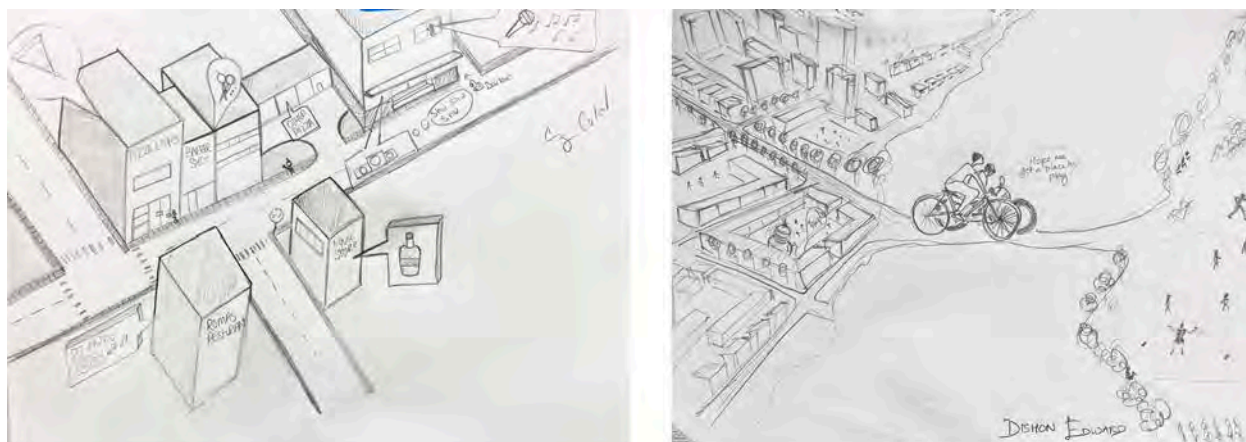

Figure 2: Cy Colon and Dishon Edward maps of hometowns described to them by a friend

The drawings offer a spatial approach that tells a different story of life experience, defined more by a landscape of interconnections between people, places and situation, than by cause-and-effect narrative. The maps also offered a human sense of ordinary, family life that gave all of us a common ground. Everyone's childhood experience is different, sometimes dramatically so, yet most have warm connections with family, friends, going to school, working, playing, and favorite places to go. Memories of the habitual places of childhood – being in the kitchen and walking along the street – are often vivid and not dependent on specific events. We hoped that students would draw while in conversation, as architects often do, and that the maps would emerge collaboratively.

In most cases, participants were happy to recall, sometimes nostalgically, the contours of the village they remembered (figure 3). Some participants drew their own maps. In other conversations, the details of ordinary life seemed like a distraction from the central narrative, an unnecessarily descriptive detour. Immigration narratives are themselves a genre that often follow a set structure: hardship at home, some precipitating event that makes emigrating necessary, a dramatic journey, adjusting to a new situation, and finally a better life in a better place. Asking to step out of the narrow confines of that narrative was sometimes unexpected, although participants were good natured and came to understand the reasons. The students, likewise, sometimes followed the narrative structure by default, to the point that their drawings became simply illustrations.

Memory maps have a specific history in Architecture. In the 1960s, Kevin Lynch asked residents of Boston and Jersey City to draw memory maps of their cities in order to learn more about how people perceive familiar places and routes. His book, *Image of a Town*, became a founding text of urbanism. From there, a field of cognitive mapping opened up in between psychology, geography, and urban design (Kitchin, 2001). Through various interpretations over time, the field currently asks questions about spatial thinking, how do people remember places and what mental capacities do they use to navigate? Maps are a tool to understand cognition.

On the other hand, the memory maps themselves have found life as a form of storytelling. Creative writers such as the "26 group" in England have used memory mapping to create spatial-narrative stories, sometimes re-presenting a journey through a landscape (<https://www.26.org.uk/projects/26-memory-maps-3>). Recall that classical epic narratives such as Homer's *Odyssey*, Dante's *Inferno* are journeys — with chapters describing each location and the events that happened there. Frances Yates in her classic history, *The Art of Memory*, relates that in the ancient Greco-Roman tradition memory itself was imagined as a place, a palace with many rooms in which one could place memories as if they were objects (Yates 1966, p.22). To retrieve a memory one could navigate through one's imagination to find the

Another suggestion was to draw an object or place that played in the narrative as if it were a character in the drama. The reasons for these rules: people are hard to draw so the drawings rarely come out well, and more pointedly, we were interested in the situations more than the narrative. We all had resist being swept away by the plot, to pause long enough to ask about the situation. In the bigger picture, the situation in Central America is dire: drought, no work, no food.

None of the narratives that the participants offered mentioned the drought in their countries. The reasons they gave for emigrating were usually personal - an abusive relationship, a fight in the family, a debt to pay. They cited proximate causes. However, in the larger web of entangled situations, the underlying reality of the drought puts inexorable pressure on the local economy, leans heavily on the self-esteem of men who take their children out of school to work in other people's fields, and fuels the sense of slow desperation that eats away at family structure. That spatial field of conditions drives the events that bubble up into narrative.



Figure 4. Estilio Iglesias' drawing of elements of Moses' narrative

Our memory maps were a gentle way to move past the confines of the immigrant narrative and find the people involved, enmeshed in their places, families, and prospects. We were not looking for why they emigrated so much as trying to appreciate their experience as part of a landscape. The maps were subjective readings of the shared material world that they experienced, complete with village soccer matches, women working on looms in the yard, and picking coffee in Mexico (Figure 5).



Figure 5. Victoria Gomes drawing based on Ana's description of her hometown in El Salvador

These spatial memories reach out into the larger shared landscape, bearing witness to the physical realities of life in Central America in which trying to cope with drought and agricultural stress is normal. The inaccuracies of the maps in particular reflect choices of what is important to both the narrator and the drawer, choices that are already filtered by social expectations and culture. In this sense then, the maps reflect a shared cultural landscape. How that landscape is affected by climate change or other environmental assault cuts to the heart of environmental justice.

The maps and the narratives from our project are now part of the Humanities Action Lab exhibition alongside work done by students in other universities. Our drawings added an element to the process of oral history, reflecting our architectural point of view. The memory maps give the project literally a new dimension, stretching linear narrative to engage spatial experience and acknowledging a dense potential for multiple stories. As Doreen Massey argues, spatial organization by its nature embraces the multiplicity of experience, indicating complex webs of connection between things. Our maps are a small suggestion as to how oral history as a practice might broaden toward spatial thinking, particularly as we consider the roots of resilience in emotional connections to each other and to the land.

For architecture students, the process of engaging narrative and mapping invited them to see the landscape not as a visual tableau but as integrated into living experience and memory. The stories they shared revealed the power of ordinary places in people's lives, physically and emotionally. And in some instances, they glimpsed the beauty of these places through someone else's eyes.

REFERENCES

- Kitchin, R. 2001 "Cognitive Maps." In *International Encyclopedia of the Social & Behavioral Sciences*, edited by James D. Wright, 79-83: Elsevier
- Massey, D. 2005 *For Space*. NY: Sage
- Yates, F. 1966 *The Art of Memory*. London: Routledge & Kegan Paul

Spatializing the Body: Loose-fit as a Feminist Practice of Architectural Research

Elizabeth Cronin¹

¹University of Florida, Gainesville, FL

ABSTRACT: Gender exclusion pervades architecture, and in response academics and practitioners have written on a range of subjects, including ‘Women in Architecture,’ ‘Gender-Bias in Architecture,’ and ‘Architecture and Feminism.’ While the extraction of these topics as their own independent subjects of study has been crucial in carving out a space for women in architecture — to identify historical inequities and theorize practices that speculate about a more equitable future — their continued development as niche sub-topics of architecture articulates feminist practice as its own line of thought (parallel to the primary discourse) rather than as an inherent part of the architectural field. This doctoral work plots feminist *practice* into the discourse of architecture. It begins by examining the work of Helen Frankenthaler to frame the theoretical underpinnings for spatializing the body. It then uses a research-creation methodology to expand from art practices to architecture practices and theorize loose-fit as a feminist practice of architecture. This project works through a series of drawings and constructions paired with speculative writing to de-objectify bodies in architecture. In so doing it spatializes the body as a method of feminist practice — using ideas of movement, subjectivity, and ‘loose-fit’ — and translates these studies into open-ended speculations about architectural space generated for and from the body. Through explorations of loose-fit, this work expands feminist theory through the cultivation and implementation of feminist practice. In this way, feminist practice may be seen as a method of research in and of itself, and the combination of theory and practice (writing and making) can play an active role in the reconstruction of a resilient and equitable architectural field.

KEYWORDS: research-creation, feminist practice, design doctorate

1.0 INTRODUCTION

We were only in Savannah for the day — passing through on our way to visit my brother in North Carolina. After fourteen months of isolation, we were thrilled to be out in the world. We were walking down a long block, marveling at the number of people, when a woman called from across the street, “Are you two here for the open house?” Our confused looks elicited further explanation, “The museum is open for SCAD Day.”

The mention of a museum piqued our interests. We hadn’t been to a museum in eighteen months. Excited, we hurried inside, and I was shocked. In the museum lobby were five prints immediately recognizable: the work of Helen Frankenthaler. I had been reading about her and her work for the last several months as part of my doctoral research and had pulled two of her paintings — *Carousel* (1979) and *Desert Pass* (1976) — into the second year design studio I had taught that previous spring. I had never seen her work in-person, and I was stunned by the experience.

For me, Frankenthaler’s work is uncanny¹ in its ability to create space through layers of thin, transparent, and fluid forms of paint. Her works express depth imbedded in a flat canvas surface, where the movement of both paint bodies and painter’s body mesh into a contingent field. Of particular interest is her construction of fields of color and space in such examples as *For E.M.* (1981), *Salome* (1978), *M.* (1977), and *Grey Fireworks* (1982). Here, Frankenthaler spatializes bodies in two ways: by making space with her own body in the process of constructing her art and by making space from the subjects of her art practice. Frankenthaler (like other “action painters”²) allows the bodies of her artistic subjects to be conceived through territories, zones, and fields, spatializing the bodies of her painted subjects by allowing for overlaps, interstitial spaces of between, and loose-fit connections between paint bodies: “her staining also asserts an unlikeness to bodily liquid substances, At times it suggests a likeness to liquids external to the body, in nature, and some of it looks too graphic, or too compacted, or too settled into its shapes, to seem very liquid at all (Elderfield 2013, 26).”

Helen Frankenthaler’s work does not setup spatializing the body as a feminist practice but instead establishes a method of *how* one might spatialize the body: through fieldal movements, subjective readings, and loose constructions of space. The following text and accompanying architecture (a set of constructed dresses) uses a research-creation methodology to translate Frankenthaler’s methods into architecture. They theorize ‘loose-fit’ as a feminist method of spatializing the body rooted in fieldmaking practices and mobility. In this study, feminist theory is cultivated in the field between writing and practice, and relationships between textiles and bodies generate architectural space.

2.0 METHODOLOGY: RESEARCH-CREATION

Expanding on traditional written doctoral research, this doctoral study reaches into art practices to adopt a research-creation methodology. A research-creation project views a document of artistic expression as having equal scholarly value as the written work. Where other models of practice-based research rely on the inclusion of the creative outcome with the text to understand the research, the execution of a research-creation project may allow the text to stand alone — where it is conceived alongside and/or generated from the creative outcome. Research-creation has been heavily discussed in the context of art practices outside of the United States (in Canada, Australia, and parts of Europe), but it can be applied across disciplines (Definition of Terms 2021). In the *Canadian Journal of Communication*, Owen Chapman and Kim Sawchuk write,

Research-creation is not so much a ‘new’ method as it is a ‘newly recognized’ academic practice that has gained ground in the past ten years...Research-creation, as a method of inquiry, questions formulaic representations of the academic genre and the production of knowledge in print cultures (Chapman and Sawchuck, 2021).”

In her manifesto about research-creation *How to Make Art at the End of the World*, Natalie Loveless defines research-creation as

an approach to research rooted in process, multiplicity, context specificity, and contingency — one that might even be called emergent (Loveless 2019, 25).

She stresses the role of interdisciplinarity and argues for research-creation as a feminist practice. This study uses research-creation to intersect practices of making, building, and writing to develop a richer understanding of what constitutes architectural scholarship. It looks outside the disciplinary confines of traditional architecture (i.e. building-scale works) to probe a definition of architectural practice that extends to an architecture of the body.

3.0 LOOSE-FIT AS A FEMINIST ARCHITECTURAL PRACTICE

3.1. Loose

For hundreds of years, *loose* and its many variants and compounds have been used as insulting descriptors of women. Such examples include *loose-woman* — used as a definition of the disparaging term *floozy*⁵ — *loose fish* — defined colloquially as “a person of irregular habits” or more rudely as “a common prostitute”⁶ — *loose-gowned*, *loose-hilted*, *loose-kirtled* — all of which mean “wanton,” as in “your *loose-hilted* Mystresses”⁷ — *loose-wived*⁸ (of which I can only imagine the implications). Of *loose-fitting*, the *Oxford English Dictionary* provides two entries. The first, an adjective with no definition, presents a line from Henry James’s “Portrait of a Lady” in *Macmillan’s Magazine* (April 1881): “Ralph had a kind of loose-fitting urbanity that wrapped him about like an ill-made overcoat (Loose-fitting, 2021).” The second provides ‘loose-fitting’ as a definition for the word *loose-bodied*. While referring to dress, this adjective is also defined (predicably) as a figure of speech for “lewd [and] wanton (Loose-bodied, 2021).” These archaic definitions frame the context of ‘loose-fit’ and contemplate the opportunity to reclaim *loose* (and by extension *loose-fit*) as a feminist term and operation.

While *loose* is associated and compounded with a number of words and phrases (88 in one *OED* definition), in most cases it is used negatively, often to describe someone or something that is ‘ill-fitting’ of appropriate expectations (be they societal, cultural, sartorial, coded, or literal). These expectations often place marginalized groups in double-bind situations where they can’t win, ostracizing any behavior that deviates from the *tight-fit* “norm.” In typical marginalizing practice, this allows hegemonic groups to retain power and control.

For as Rosalind Miles wrote in *The Women’s History of the Modern World*

The moral of this story is that women cannot carry out a revolution for women within a revolution led by men. Interpreted as a revolution *against* men, it cannot be tolerated and must be put down (Miles 2021, 29).

If women want to make a mark on the architecture profession, not only does the revolution have to come from us (and our allies), but it also needs to come from outside the *tight-fit* of traditional male-dominated architecture practice. Instead of seeking to carve out a space for women within the established fit of architecture structures — to merely break old habits and write women in⁹ — we should *loosen* our definition of architecture, building new space (rooted in practices outside the boundaries of the discipline) and establishing new territories for the architecture profession. As a reclaimed feminist word, *loose* may become defined as something unbound, uncontained, fluid, or liberated, and *loose-fit* can become a practice “where partial coalitions, unresolved tensions, or uneasy alliances need not be divisive, when collaboration and connectedness, not consensus and closure, are feminist goals (LeMoncheck 1998, 373).”

3.2. Theorizing Dress: Loosening as Feminist Practice of Liberation

Comparisons of architecture and dress are not new. Adolf Loos’s essay “Underclothes” (1898) uses dress to describe the tailored-fit of male overclothes as a mask and façade for integrating the modern man into society — once the tailored and fitted overclothes are removed, a man’s *loose-fitting* undergarments render him mobile and unrestrained (Loos 1982). Mark Wigley, too, explores the connections between dress and architecture. In his book *White Walls, Designer Dresses*, (1995) he observes the dress code of modernism, saying:

Supposedly, modern architecture strips off the old clothing of the 19th century to show off its new body, a fit body made available by the new culture of mechanization (Wigley 1995, xviii).¹⁰

My explorations of *loose-fit* also begin with dress. Interestingly, the ideology surrounding the ‘liberated woman’ can be traced through the loosening of her dress and undergarment structure. *Tight-fitting* corsets yielded to girdles (and later, to brassieres) as women moved outside the home. H. Kristina Haugland (associate curator of Costume and Textiles at the Philadelphia Museum of Art) points out that at the time of Loos’s essay (1898) corsets were the primary female underclothes (Haugland 2012). For a woman at this time, clothing was expected to abide to values of “purity” and “modesty.” Counter to this notion is the fact that corsets and feminine undergarments fit so tightly as to put the female body on display — shaping breasts, waist, and hips. The *tight-fit* between body/undergarment and undergarment/overgarment simultaneously restricted movement and autonomy while exposing the very form that the heavy and “modest” clothing claimed to hide (Figure 1).



Figure 1: Tight structuring exposes the body it covers. Image Source: Author, 2021.

In the 1920s, women began to shed their corsets for more mobile undergarments and enter the work force (Haugland 2012). Skirt/hem lines were shortened and
for the first time in western history, you could see how women moved around...you could see them walking (Haugland 2012, 51:42-52:10).

By the 1930s, with the introduction of the brassiere, women’s undergarments shifted completely. While some women continued to wear a girdle to slim their bodies — a small improvement from the harsh shaping authority of the corset — others began to wear only brassieres which offered little support (Haugland 2012). This provided a *looser-fit* between the female body and its outermost layer. Repeived of its structuring responsibilities, women’s clothing began to move from being a corseted structure — a shell which preferences static control — to a loosely fitted perimeter — a *delaminated* skin that establishes space for movement (Figure 2). This delamination of the overclothes from the underclothes lends itself to a more liberated relationship with the exterior and actually — in its pulling apart — creates a less exposed structure.



Figure 2: Dress delaminates from the body, creating space between body and textile. Image Source: Author, 2021.

Of course, these changes were not merely fashionable — new styles were driven by new roles held by women, and clothing structure did not present a linear evolution towards progress. At the end of World War II (after many women had worked outside of the home), the return of male soldiers from the front led to a ‘re-domestication’ of women on many fronts, including dress:

Like the role of women in society, American mores had swung sharply one way — toward liberality — during the war, and just as violently back to toward puritanism when the conflict ended...Books and movies were censored, women’s fashions were designed to hide real curves under layers of false ones. Christian Dior set the pace for skirts, which flared so wide over a multitude of slips that there was no possibility a woman might be suspected of having legs underneath them. “When a girl took off her underpants in 1947,” Anatole Broyard said, “she was more naked than any woman before had ever been (Gabriel 2018, 90).

As an ideological strategy, the girdle was re-introduced and women’s bodies were once again strangled by the *tight-fit* norms of a rebuilding society...and on it goes. In a direct overlap with architecture, a 1970s advertisement for the product “Scantyhose” read “Less is More” (Haugland 2012).

Today, fit continues to play a role in the construction and exposure of the body. While underwear has loosened, outerwear has tightened — they have even merged! With the rise of athleisure wear, the flexibility of spandex may allow a piece of clothing to conform to a range of body shapes and sizes, but the wearer has no choice in the structuring or shaping. Here, clothing essentially acts as a second skin with no space between body and clothing and no room for interpretation or subjective choices (Figure 3). On this Jia Tolentino writes:

Spandex — the material in both Spanx and expensive leggings — ...is uniquely flexible, resilient, and strong...but this sense of reassurance is paired with an undercurrent of demand. Shapewear, essentially twenty-first-century corseting, controls the body underclothing; athleisure broadcasts your commitment to controlling your body through working out. And to even get in a pair of Lululemons, you have to have a disciplined-looking body...“Self-exposure and self-policing meet in a feedback loop,” Weigel wrote. “Because these pants only ‘work’ on a certain kind of body, wearing them reminds you to go out and get that body. They encourage you to produce yourself as the body that they ideally display (Tolentino 2019, 83-84).”

So, why is this important? The *loosening of fit* falls in line with a long history of liberating feminist practices (from the loosening of clothes, domestic spaces, definitions of feminism, etc.). *Fit matters*.

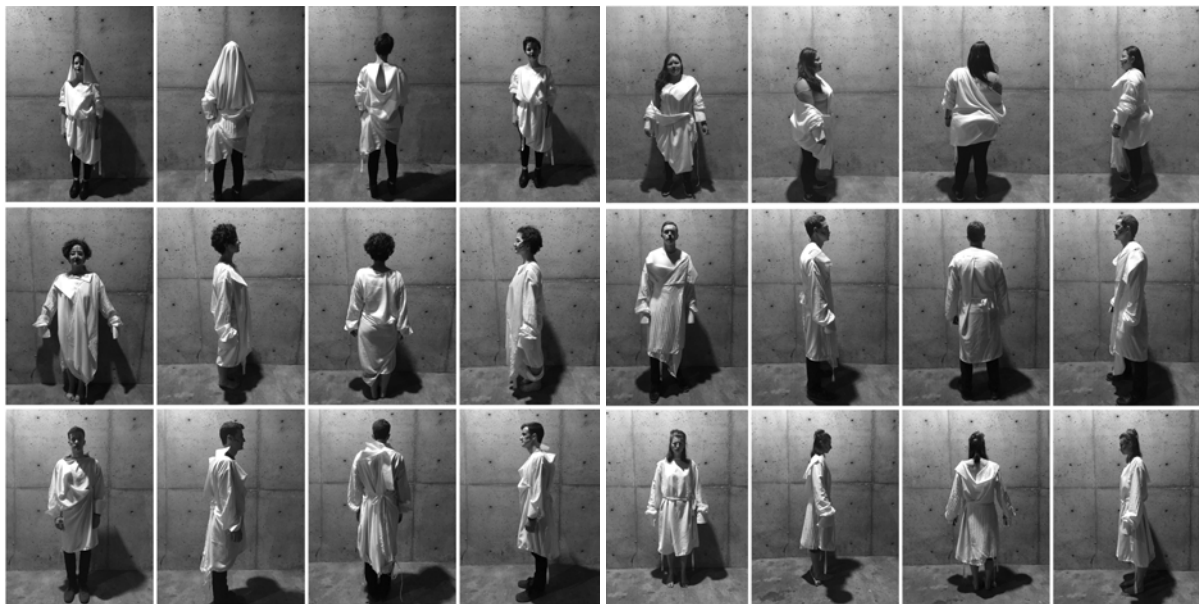

Figure 3: Subjective readings of dress. The same dress is worn and structured across a field of bodies. Image Source: Author 2021.

3.3. Loose-fit

Perhaps my predisposition for *loose-fit* comes from my personal clothing preferences — space to move, space to breathe, space for air. In this, ‘space’ is the operative word. Loose-fit is constructed between bodies in space. Here, I expand the definition of *body* to include both physical and conceptual figures that are given form, shape, or presence (‘embodied’). This may include human/living bodies, film-bodies (or film-beings), landscapes, bodies of water, bodies of knowledge, etc. Loose-fit is all about in-between space, and it denotes a series of operations between a structuring body and a fluid body: lamination and delamination, anchoring and floating, stretching and contracting, etc. In this way, *loose-fit* creates spaces of tension between two bodies — bodies of writing and making (Figure 4), landscape and

building, clothing and person, line and tone; where each body may act as an independent system that is supported by and connected to the other; where moments of freedom/release are balanced by moments of joining. Here, though seemingly contradictory, the best of each quality — *loose* and *fit* — are implemented to create a space (of between).



Figure 4: "Architecture and Feminism: Rereadings of Modern Domestic Space," gallery exhibition, University of Florida. This exhibition provides an example of a research-creation project. It constructs loose-fit connections between dressmakings from my Master's Research Project (MRP) and writings from my Master of Science in Architectural Studies thesis. Here, feminist conditions of body, fit, and dress are examined at the scale of three modern homes. See Cronin, Elizabeth. "Evolving Ideologies: Feminist Rereadings of Modern Domestic Space." In *VORKURS:Exquisite Corpse*, edited by Jamie Lindsey, 138-157. University of Florida, 2018. Image Source: Author, 2021.

Finally, of most important value to this research, *loose-fit* creates opportunities for field-making (Figure 5). It moves beyond hard, rigid edges and boundaries (objects) of *fit* to create room for slippages between bodies in space, inside and outside, theory and practice, writing and making. *Loose-fit* allows for fluid and subjective interpretations of *how* things fit, and in the construction of field conditions, *who or what* is permitted to fit. The beauty of artistic research is the ability to learn through making, take on "uncertainty, potentiality, and creativeness (ARCC call)," and allow the open-endedness of processes, interrogations, and experimentations to provide fertile ground for explorations that yield not answers but more questions. How can research-creation methods loosen architectural practice? How can fieldal constructions of architecture and its adjacent disciplines break the tight-fit norms of traditional architecture practice? How might architecture of the body translate to architecture for bodies? What might it mean to dress the landscape? Future doctoral explorations will seek to address these questions, where 'loose-fit' provides an uncanny, feminist method for engaging with architecture practice.



Figure 5: Ink and acrylic on bed sheets. These 1:1 scale mappings spatialize a body getting dressed (left) and undressed (right). The mapping of bodily movements constructs fieldal readings of space generated from/for the body. Image Source: Author, 2021.

ACKNOWLEDGEMENTS

I thank my doctoral and graduate committees for their vital discussions and encouragement during this research: Professor Donna Cohen, Dr. Charlie Hailey, Professor Nina Hofer, and Professor Bradley Walters. I also thank my classmates for their whole-hearted participation and subjective choices of dress: Kristel Bakatu, Jamie Lindsey, Forrest Murphy, Laura Rodriguez, and Zachary Wignall.

REFERENCES

- Chapman, Owen and Kim Sawchuk. 2012. "Research-Creation: Intervention, Analysis and 'Family Resemblances'." *Canadian Journal of Communication*, 37: 5-26. Accessed September 24, 2021, <https://cjc-online.ca/index.php/journal/article/view/2489/2766>.
- "Definitions of Terms." SSHR. Accessed November 10, 2021. <https://www.sshrc-crsh.gc.ca/funding-financement/programmes-programmes/definitions-eng.aspx#a2>.
- Elderfield, John, curator. 2013. *Painted on 21st Street: Helen Frankenthaler from 1950-1959*. Abrams, New York: Gasgolian Gallery.
- Gabriel, Mary. 2018. *Ninth Street Women: Lee Krasner, Elaine de Kooning, Grace Hartigan, Joan Mitchell, and Helen Frankenthaler: Five Painters and the Movement that Changed Modern Art*. New York: Little, Brown and Company.
- Haugland, H. Kristina. 2012. "Revealing Garments: A Brief History of Women's Underwear." Presentation, Philadelphia Museum of Art. Youtube. <https://www.youtube.com/watch?v=AJ6eqMgn5u0>.
- Humm, Maggie. 1997. "Feminist Theory, Aesthetics and Film Theory: Mulvey, Kuhn, Kaplan and hooks." In *Feminism and Film*. Bloomington: Indiana University Press.
- LeMoncheck, Linda. 1998. "Loose Women, Lecherous Men: A Feminist Philosophy of Sex." *Philosophical Studies: An International Journal for Philosophy in the Analytic Tradition* 89, no. 2/3.
- Loos, Adolf. 1982. "Underclothes." In *Spoken into the Void: Collected Essays 1897-1900*, translated by Jane O. Newman and John H. Smith. New York: MIT Press.
- "Loose-bodied, adj." *Oxford English Dictionary*. Accessed October 8, 2021. <https://www-oed-com.lp.hscl.ufl.edu/view/Entry/110192?rskey=XrCHF0&result=2&isAdvanced=false#eid112749894>.
- "Loose-fitting, adj." *Oxford English Dictionary*. Accessed October 8, 2021. <https://www-oed-com.lp.hscl.ufl.edu/view/Entry/110192?rskey=XrCHF0&result=2&isAdvanced=false#eid112749894>.
- Loveless, Natalie. 2019. *How to Make Art at the End of the World: A Manifesto for Research-Creation*. Durham & London: Duke University Press.
- Miles, Rosalind. 2021. *The Women's History of the Modern World: How Radicals, Rebels, and Everywomen Revolutionized the last 200 Years*. New York, NY: HarperCollins Publishers.

Tolentino, Jia. 2019. *Trick Mirror: Reflections on Self-Delusions*. New York: Random House.
Wigley, Mark. 1995. *White Walls, Designer Dresses*. Cambridge, Massachusetts: The MIT Press.

ENDNOTES

1 On 'the uncanny,' Natalie Loveless says, "in other words, the radical undecidability that constitutes the uncanny includes within it a drive towards knowledge; the uncanny instantiates a (curious) drive that hovers at the intersection of knowing and not knowing, belonging and not. You can't be curious about something you already know, but you need to know something about it in order to be curious." In Natalie Loveless, *How to Make Art at the End of the World: A Manifesto for Research-Creation* (Durham & London: Duke University Press, 2019), 47.

2 "Second, the analogy depended upon the unusual thinness and apparently self-generated spread of Frankenthaler's stains, which attracted the attention they did because they appeared in a period of heavily impastoed paintings—'action paintings'—that had allowed and prompted a valorizing of the actions of the artist." In John Elderfield, curator, *Painted on 21st Street: Helen Frankenthaler from 1950-1959* (Abrams, New York: Gagosian Gallery, 2013), 26.

3 Humm notes, "Mulvey's essay marked a huge conceptual leap in film theory: a jump from the ungendered and formalistic analyses of semiotics to the understanding that film viewing always involves gendered identities." In Humm, Maggie, "Feminist Theory, Aesthetics and Film Theory: Mulvey, Kuhn, Kaplan and hooks," in *Feminism and Film* (Bloomington: Indiana University Press, 1997), 17.

4 See such texts as Beatriz Colomina, "The Split Wall: Domestic Voyuerism" in *Sexuality and Space*, ed. Beatriz Colomina (New York: Princeton Architectural Press, 1992), 73-130.; Colomina, Beatriz, *Privacy and Publicity* (Cambridge, Massachusetts: The MIT Press, 1994); and Wigley, Mark, *White Walls, Designer Dresses* (Cambridge, Massachusetts: The MIT Press, 1995).

5 'Loose-woman' can be found in Merriam-Webster's definition of a *floozy*: "a usually young woman of loose morals." Floozy is accompanied by a handful of sexist synonyms and my ire at its existence. In "Floozy," Merriam-Webster Online, accessed October 8, 2021, <https://www.merriam-webster.com/dictionary/floozy>.

6 In 1809, the phrase loose fish was used by Alain René Le Sage in *The adventures of Gil Blas of Santillane* (translated by Benjamin Heath Malkin) where he said: "Girls in a servile condition of life, or those unfortunate loose fish who are game for every sportsman." In "Loose fish, *n.*," Oxford English Dictionary, accessed October 8, 2021, <https://www.oed-com.lp.hscl.ufl.edu/view/Entry/110192?rkey=XrCHF0&result=2&isAdvanced=false#eid112749894>.

7 These words were written by Richard Brome in his *Five new playes* in 1652. In "Loose-hilted, *n.*," Oxford English Dictionary, accessed October 8, 2021, <https://www.oed-com.lp.hscl.ufl.edu/view/Entry/110192?rkey=XrCHF0&result=2&isAdvanced=false#eid112749894>.

8 In Antony & Cleopatra Shakespeare wrote, "It is a heart-breaking to see a handsome man loose-Wiu'd." In "Loose-wived, *adj.*," Oxford English Dictionary, accessed October 8, 2021, <https://www.oed-com.lp.hscl.ufl.edu/view/Entry/110192?rkey=XrCHF0&result=2&isAdvanced=false#eid112749894>.

9 See Debra Coleman, "Introduction," in *Architecture and Feminism*, eds. Debra Coleman, Elizabeth Danze, and Carol Henderson (New York, NY: Princeton Architectural Press, 1996), xiv. "Grosz's analysis points to the absence of the feminine at the very heart of architectural discourse...just sketching 'her' in now is not enough. The issue is not really what architecture lacks, what is overlooked in its conception, what nuances are ignored. Rather, space and place must be reconceptualized."

10 Wigley does not extend this new 'fit' to women. Of a sketch of dresses designed by Le Corbusier he says: "the dresses grant the woman a freedom to move but only within the strict confines of an ostensibly male gaze. The loose surfaces of the dress are closely scrutinized for erotically charged traces of the movements of the body that they conceal." In Mark Wigley, *White Walls, Designer Dresses* (Cambridge, Massachusetts: The MIT Press, 1995), 271.

Inclusive Pedagogies in Theory Sequence Courses

Larisa Sherbakova¹, Shayla Thomas¹, Amanda Grace¹, Basma Binmahfooz¹

¹Florida Agriculture and Mechanical University, Tallahassee, FL

ABSTRACT: Theory courses can be tailored to fit diverse student populations, thereby providing an all-inclusive, healthy, and more engaging framework for students to learn architecture. In this paper, inclusive pedagogy will be demonstrated through examples and comparison of Theory One and Theory Two courses taught at an HBCU (Historically Black Colleges and Universities), Florida Agriculture and Mechanical University (FAMU), during the Fall 2020 and the Spring 2021 semesters. The first theory course in the Fall semester was taught traditionally, with an emphasis on Vitruvius, Alberti, classical, and modern architecture. Students read original treatises, wrote papers on learned materials, took regular quizzes, participated in discussion sessions, and submitted two research papers throughout the semester. The second theory course in the Spring semester implemented new, engaging pedagogies. Students analyzed building design through the lens of Black culture by working on a real-life school renovation project in the Black community, learned about hip hop architecture, diverse landscapes, Black space design concepts, and completed indigenous architecture research and design projects. Students are co-authors of this paper and will provide critical feedback on learning challenges, improvements, and suggestions for both semesters. Student feedback, level of engagement, and quality of work significantly improved in the second semester compared to the first semester. The library of teaching pedagogies is vast and there are many ways to teach. However, a pedagogy that is responsive to its student body will result in students that are responsive to the class, their community, and, as future architects, are better empowered to produce inclusive architecture.

KEYWORDS: Inclusive Pedagogy, Empower, Black Culture

INTRODUCTION

In order to create an equitably built environment for different populations, educators should implement inclusive pedagogies with an emphasis on cultural and social diversity and the importance of community engagement. In this paper, an experimental Design Analysis course incorporating inclusive pedagogies will be described, and its outcomes will be evaluated by the students in a question-and-answer format.

Design Analysis is the second Architecture Theory sequence course continuing the examination of the intellectual tradition of architectural practice. From Fall 2020 to Spring 2021, I served as a visiting associate professor at an FAMU. As a young faculty member who was appointed to teach two theory courses, I proceeded to teach Theory 1 traditionally, with an emphasis on the fundamentals of architecture theory, covering the typical major theorists and major architecture movements. Students read original treatises, wrote papers on learned materials, took regular quizzes, participated in discussion sessions, and submitted two research papers throughout the semester.

Even though the student feedback seemed positive overall, I had a difficult time connecting my truly diverse class of majority Black students with the course content, as the primary study focused on architecture developed by privileged white males who are often lauded as having shaped the contemporary architectural world. As architects and designers, we always look at the context, the importance of which cannot be understated. In academia, the student body is the context and one of the primary factors which define the way a course can be taught. With that in mind, the decision was made to teach Black architecture in the second theory course in order to create inclusivity and to engage the students more.

1.0 DESIGN ANALYSIS COURSE STRUCTURE

1.1 Design analysis from a Plan

The first assignment of the semester was “Design Analysis from a Plan”. The exercise dealt with analyzing the plan drawings and creating design solutions in two- and three-dimensional form based on the conducted analysis and application of classical, modern, and postmodern architecture principles. The buildings were famous works of architecture, but the names were not disclosed to the students. Students were to reconstruct the houses based only on the provided floor plans. This was a warm-up exercise which aimed to refresh students’ knowledge and memory of classical and modern canons. The project duration was two weeks. The example in Figure 1 shows the original Gropius House and two elevations (one modern, one classical), which the student developed from the provided plan.

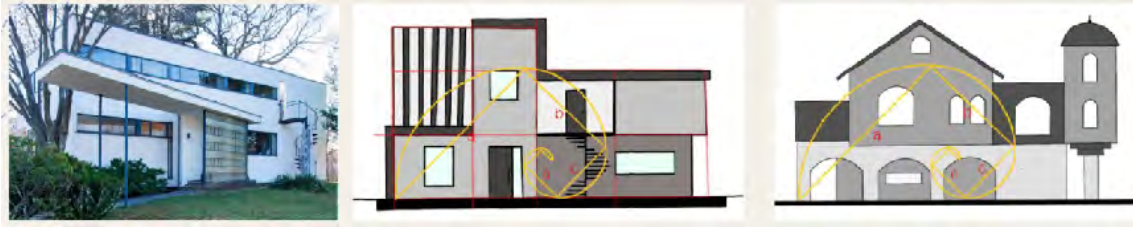

Figure 1: Design Analysis from a Plan. Source: FAMU student work

In Figure 2, the student analyzed Breuer House II and used diagrams and regulating lines to reconstruct the elevations.

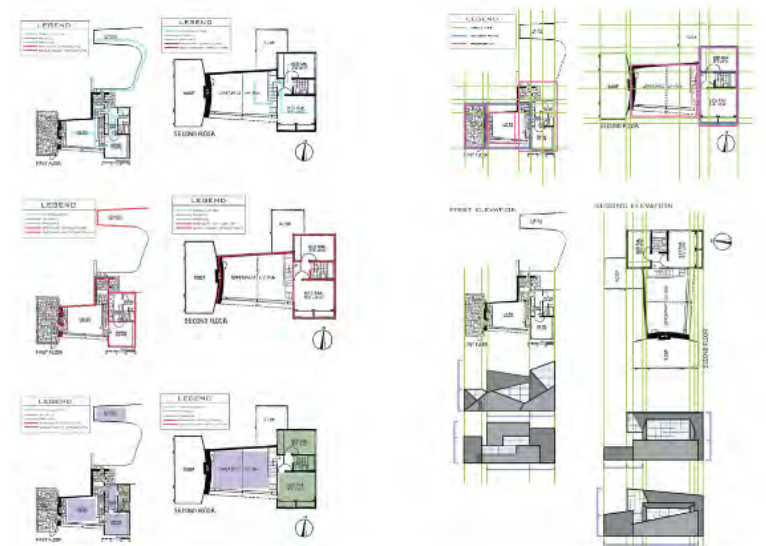

Figure 2: Design Analysis from a Plan, analytical diagrams. Source: FAMU student work

1.2. Design analysis through the lens of Black culture

The second assignment of the semester was “Design Analysis through the lens of Black Culture” which was broken into three parts:

- 1) Students were given a list of buildings representing Black architecture. In teams of two, the students documented and researched the precedents.
- 2) In teams of four, students had to combine their precedents and create analytical boards with diagrams and images which would show analysis of the buildings through the use of mimicry, allusion, analogy, and experience. These four terms were discussed with the faculty and implemented as part of the assignment and as a guide for students to analyze their buildings.
- 3) The final part of this assignment was to write a paper on a new building from the list representing African-American culture and analyze it utilizing what students learned in part one and two of the project.

This project lasted four weeks and included presentations by invited guests, critique by design professionals at each stage of the assignment, and lectures illustrating how Black architecture can be analyzed in terms of mimicry, allusion, analogy, and experience. Some of the challenges the students faced during this project was finding information on Black architecture in order to analyze the building design through the lens of Black culture. For example, in the American past, black people did not often receive credit for their work, particularly during the slave-era, where credit would have gone to the master and not the craftsman-slave. Though this does not mean there was no Black architecture from this time period, it does make determining historical Black architecture more difficult. The difficulty was discussed and further commented on by the invited critiques and fellow black professionals. An example of project two analysis boards follows below in Figure 3.



Figure 3: Design Analysis through the Lens of Black Culture. Source: FAMU student work

1.3. School renovation project in the black community

Project three was a school renovation project in the black community. This project was brought to class by the Institution’s alumni. He presented the project during one of the classes, and the students were asked to give input on the design process of the architect’s project with their ideas on how to incorporate features from their study of Black culture into the new school’s design. A short, one-week project included research of the project location and the students’ proposal presentations. This project allowed students to implement their knowledge in a real-life application. The importance of community integration and cultural and social diversity was showcased in this project.



Figure 4: School Renovation Project Sketch. Source: FAMU student work

1.4. Vernacular Architecture, dwelling and urban analysis, on a city in Asia, India, Africa, Latin America, or Caribbean

Students were asked to analyze and provide sketches illustrating a typical dwelling of the city of their choice and diagram how it creates the fabric of the particular neighborhood. Then, students created a new dwelling design based on the context of the place and the vernacular principles discussed in class. At the end of the four week-long assignment, students wrote a research paper documenting their findings on vernacular architecture. Students benefited from exposing themselves to diverse forms of vernacular architecture, and were able to incorporate new design into their work, as shown below in Figure 5.



Figure 5: Barbados Vernacular Architecture, analytical diagrams. Source: FAMU student work

Throughout the semester, the students were introduced to hip-hop architecture, Black space design principles, and diverse landscapes. Throughout the semester, invited lecturers introduced students to important figures and new trends in Black architecture and provided critiques of students' work.

2.0 STUDENT'S FEEDBACK

2.1. Student 1 Biography

I am a fourth-year architecture student at FAMU, originating from Maryland. I am currently president of Alpha Rho Chi, Fraternity, Inc. and a member of AIAS and Women in Architecture. In summer 2021, I completed a research fellowship with Gensler Architecture firm where I, along with my small group, were responsible for researching the effectiveness of previously implemented strategies that measure the function success of current and future developments. I am very grateful for the opportunity, as it has shown me what life could be like at a large firm. I would like to get more experience in other areas of design to see what the best fit for me is.

2.2. Student 1 Responses to Questions

What benefits do you see in inclusive pedagogies vs traditional curriculum?

During the semester that inclusive pedagogies were used, I was exponentially more interested in the course than I thought I would be. I expected to be learning about buildings that everyone has heard of that have all been designed by old, white, now dead men. After the course, I see now that architecture is progressing beyond solely being affected by old white men. Our curriculum and lessons should be exemplifying that as well, especially at an HBCU where we are constantly looking for representation in a field that historically lacks it. Learning about the same architects is redundant when there are emerging and existing architects to reference and learn from. It was refreshing learning about vernacular architecture and Hip-Hop architecture because we had not before, and this prompted interest not only in our class, but other students were interested in what we were learning and learning along with us.

What were the assignments you enjoyed the most?

I enjoyed the vernacular architecture assignment because even though we learn about it in History, we do not study it in-depth. I enjoyed researching how native cultures used their natural environment to effectively heat and cool their homes and learning about everyone else's native groups. It was refreshing to have an assignment that focused on native POC and their approaches and impacts on architecture. While it was difficult to find a country that interested me and met the requirements of the project, it was exciting to learn about multiple different architecture styles while on my search.

Which were the assignments you wish were different, and how? Any assignments you would eliminate?

I enjoyed both the vernacular and hip-hop architecture projects. However, I wish more time could have been spent on them because we were moving at such a fast pace. I did not personally enjoy the modern versus classical assignment, but I do think it is necessary to know the difference between architectural styles and that assignment was the most interactive way to learn about it.

What was the most challenging part of working on the school renovation project in the Black community?

The hardest part of that project was finding ways to celebrate the culture without mimicry. Even though mimicry was one of the strategies taught to us in order to celebrate culture, I felt that it was an easy cop out and I wanted to challenge myself and prove that a deeper and more authentic connection could be made.

Do you agree with Black space design concepts?

I agree with Jack Travis' 10 Principles of Black Space Design, because while they seem simple, they are very important in the grand scheme to make sure that your design is inclusive and implemented in the correct way.

What impacted you the most?

What impacted me the most was not necessarily the information, rather, it was that the professor wanted us to learn and wanted to teach us about these cultures and to teach Black, POC, and white students about appreciation of culture over appropriation.

Were you able to use diverse landscapes in your design projects?

Up until recently, we were not given many diverse landscapes. Most of our sites are in Tallahassee. Unless we decide to do competition outside of school, a lot of our sites are similar year to year and that is not how the professional world works.

Did you use hip hop architecture or any precedents by black architects in your design work after?

Truthfully, I have not. But this process, reflecting on the class, is making me want to look into more precedents that I am interested in other than those from starchitects.

If this course was taught again, what would you recommend doing differently?

I wish that in the course we were able to explore the cultures a bit more thoroughly. So maybe if there were multiple classes to teach about the different cultures that would be better.

Do you think it was a good idea to teach Black architecture instead of traditional design analysis of buildings? Do you think there should be more courses teaching indigenous/vernacular/Asian architecture?

Yes! I am in complete support of what we were taught in the class and I would jump at the chance if more classes like this were offered.

Will you make it (Design Analysis) into a new course and as part of the curriculum?

I think that "traditional" design analysis could be combined with architectural history, and in its place at least one class about the culture outside of European architecture could be taught as part of the curriculum.

Were there any "aha" moments related to cultures and architecture/information covered/etc.?

I think they were all "aha" moments because I had not researched these different architecture styles before.

2.3. Student 2 Biography

I am a fourth-year architecture student at FAMU, aspiring designer, and a mom of two. I was previously a mathematics major, having worked selling property-casualty insurance for five years, followed by the next four years of raising my two sons as a stay-at-home mom. As a young designer, I crave the adventurous route of researching style, implementing conscious and responsible design, and serving the needs of people. I desire to better communities and pour equity and inspiration back into society at large, giving back through architecture what architecture has given to me. In my work as a Design Intern at both SOM New York and Architects Lewis+Whitlock, I am learning the importance of the sharing of experience. As we sit around a design table, we both have to share and be willing to equally listen. I believe this thread of humanity should exist in the world throughout. I seek to both build spaces that invite and cultivate this sense of inclusion as well as live my daily life in a matter which reflects this heartbeat.

2.4. Student 2 Responses to Questions

How did studying black culture affect you?

I was incredibly thankful to be a part of the culture conversation. It was interesting to me to hear from my fellow peers, most of whom are black (I am white). I heard a lot of how their experience has been shaped by the color of their skin and the community they grew up in. I appreciated the space to ask questions and learn about apartment/low-income housing systems and the suffocating spaces underserved communities have been given. The conversations have encouraged me to be mindful of how I view communities, privilege, and product. I hope to see more community involvement and outreach to hopefully reshape how low-income housing is approached.

Were the invited guests helpful?

We had more collaboration with outside speakers and architects, and while it was engaging and interesting, it was rather clunky at times because the guest was not always privy to the intricacies of the lessons and would not always have specific directed feedback. I do think the way the design analysis class was taught was almost an abbreviated studio. We were required to work a lot and it was an intensive class. I gained an immense amount of applicable knowledge from it and worked very hard for it. I believe that having the additional perspectives from practicing architects and designers was interesting as we are continuing to develop our sense of style and vocabulary for analyzing the built world around us.

What projects did you find most interesting?

I really enjoyed writing the essay on street art (project 2, design analysis through the lens of Black culture). Researching the building that reshaped a community and infiltrated a suburban neighborhood with new culture and commerce, it was interesting to see how the evolution of the architect's main facade features caused for pause and deep reflection.

I enjoyed the exercise of finding architecture that spoke to me, researching it, and then compressing all of my thoughts into an exposition of my understanding of what this piece of architecture meant to the artist, the community, and the culture at large. Understanding the scale of influence that architecture can have helped me to better grasp the influence that I will have as a designer and respect the platform that each designed piece could be.

I think most notably from each class, more than facts, thoughts, and theories, we were encouraged to develop our own opinions. We were encouraged to look at the world and breathe it in, digest it, and articulate an opinion. This process of critical thinking and thoughtful engagement has been most useful in my studio classes as I develop my concepts and defend them in my design.

2.5. Student 3 Biography

I am a senior undergraduate student at FAMU. Originally from Yemen, I was born and raised in Saudi Arabia. In 2017, I moved to the United States to start my education in the field of Fine Arts. I received my Associates of Arts degree and decided to continue into the field of architecture. I am part of the Women in Architecture organization, and my goal is to become a successful architect with an emphasis on designing sustainable buildings that focus on residential housing, mixed use, and commercial spaces. To me, architecture is about creating meaningful experiences, growing communities, and, most importantly, improving the quality of life.

2.6. Student 3 Responses to Questions

Did studying hip hop architecture impact your work?

I appreciate including music and art to demonstrate how architecture has such a huge impact on the lives of people. Hip hop is a strong new manifesto - the voice of the discipline that has been underserved, disenfranchised, and silenced.

What benefits do you see in inclusive pedagogies vs traditional curriculum?

Inclusive pedagogy was a driving force through the entirety of our design analysis course. It is a student-centered strategy that fosters a welcoming and engaging learning environment for all students in the classroom who have diverse backgrounds, learning styles, and physical and cognitive abilities. Studying in a country that is not my country of origin, I appreciate giving voice to all people.

What was your favorite project? What impacted you the most? What surprised you the most?

I enjoyed researching famous Black architects' work, such as the International African American Museum, through the lens of mimicry, allusion, analogy, and experience. This project helped me understand these terms throughout the design of the building. For instance, mimicry was seen in the landscaping by having concrete carved out to represent the body shapes of Brooks map. Therefore, walking under the museum, you will experience the carvings of human bodies. Without literally stating the slave trade, it is a good allusion used through architecture design.

Did you like invited guests?

The guest lectures aided my learning in a more engaging, topic-specific manner. These visitors contributed to making the lessons more approachable and engaging to us.

Would you make Design Analysis into a new course/courses?

I prefer to have a choice of choosing more than one course of Design Analysis. It could be two or three Design Analysis courses, but each one would have different topics. For instance, having a Design Analysis course that focuses on the city and examines the history of the 20th century cities and another course that analyses architecture through different cultures and religions. It is interesting how students can learn many different things about cultures only through architecture. This is how I learned about Turkish culture in the last project.

CONCLUSION

Inclusive pedagogies create a more engaging and healthy ambiance for students to study architecture. An ever-evolving world needs to bring attention to diversity and engage communities in the built environment as well. This can be achieved by listening to the voices of a diverse student population and always adjusting curriculum in architecture schools in order to remain reverent, responsive, and relevant. Students are the architects of the future. Teaching them with an inclusive pedagogy empowers them to bring their voice and culture into the stream of architecture. Furthermore, exposing them to an array of other cultures and voices, and using the architecture classroom as a playground to create an architectural discussion of culture, provides students with the framework to construct a future architecture that is inclusive.

REFERENCES

- Anderson, S., Wilson, M.O. 2020. *Reconstructions. Architecture and Blackness in America*. Museum of Modern Art, New York
- Cooke, S. 2021. *Sekou Cooke on Hip-Hop Architecture*. Knoll Works
- Ford, M. 2017. *Hip Hop Architecture: The Post Occupancy Report of Modernism*. TEDxMadison
- Hartt, D. 2021. *Reconstructions Portrait: Germane Barnes on Reframing Blackness*. Pinupmagazine.org

Discrimination and Design: Equity, Justice, and Architectural Education

J. Philip Gruen¹

¹Washington State University, Pullman, WA

ABSTRACT: The tumultuous events of 2020 inspired a reckoning about equity, social justice, and systemic racism, particularly in the United States. Have architecture programs shifted their missions, curricula, or methods in response? The purpose of the study is to explore pedagogical turns in architectural education towards equity and justice (from single courses or mission statements to entire frameworks for reimagining the curriculum). Solidarity with marginalized communities and underrepresented peoples was quickly emphasized by U.S. organizations such as ACSA, the AIA, and NAAB in the wake of the murder of George Floyd, but it may take time to establish a focus on equity and justice within an architectural program. The paper's initial findings derive from website investigations of thirty (30) accredited public and private programs drawn from across the United States, some twenty-five (25) of which show some indication that equity and justice are important to their pedagogy. A brief look a graduate theory course I taught at Washington State University on "Discrimination and Design" in fall of 2020 and 2021 may begin to suggest ways that equity and justice either can be inserted into a curriculum—or made integral to it. The outcomes of this study raise as many questions as they do answers, and it is acknowledged that more investigation must be undertaken to determine from how deeply architectural programs are integrating or exploring issues of equity and justice—and in what ways. We must also assess programs on equity and justice over the next several years and continually ask ourselves how we might bring these issues into the classroom, the studio, and the streets. Yet as a preliminary study which highlights the rise of equity and justice initiatives in architectural education, evidence suggests that further research is, at least, warranted.

KEYWORDS: Equity, Justice, Pedagogy, Curriculum

INTRODUCTION

In the wake of the murder of George Floyd, the Associated Collegiate Schools of Architecture (ACSA) announced a desire to transform architectural education. "We understand that architectural education," the ACSA stated, "has for too long accepted white privilege as the norm, limiting diverse voices and marginalizing the discipline's impact on society." Acknowledging the complicity of architecture in perpetuating systems of oppression, ACSA vowed to make architecture more "accessible, inclusive, and equitable" (*Architect Staff* 2020).

The ACSA is not alone in its solidarity with marginalized peoples and communities. Several organizations of architecture and design in the United States offered commitments to equity and justice in 2020, including the American Institute of Architects (AIA), the National Architectural Accrediting Board (NAAB), the National Organization for Minority Architects (NOMA), the National Council of Architectural Registration Boards (NCARB), the National Trust for Historic Preservation (NTHP), the Society for Architectural Historians (SAH), the American Planning Association (APA), and the American Society of Landscape Architects (ASLA). Though the details of their statements varied, for the most part these organizations collectively recognized their role in perpetuating a largely white, colonial system of segregation and exclusion through (and by) design. They called for action in architectural practice and pedagogy, not words: to support Black, Indigenous, and Peoples of Color (BIPOC) in particular but all marginalized and underrepresented people in general.

It is too early to tell whether white privilege is no longer the "norm" in architectural education. Yet preliminary findings suggest that areas of equity and justice are, at least, becoming more integrated into the teaching philosophies of architectural programs—if not into their missions and visions.¹ This unfunded study, based upon an examination of thirty (30) NAAB-accredited architecture program websites in the United States, contends that there is a rising consciousness towards equity and justice in architectural education. A brief examination of a required graduate course at Washington State University that I restructured and taught in fall 2020 and fall 2021 as an active-learning seminar with the new subtitle "Discrimination and Design" demonstrates but one example of this rising consciousness. It also suggests a way, through teaching methods that encourage open discussion on difficult topics while requiring students to select some of the course material, that issues of equity and justice can be introduced or reinforced in an architecture curriculum. Yet it is hardly the only way.

Evidence of increased efforts towards equity and justice in architectural education is also revealed by statements or proclamations of empathy and/or solidarity offered prominently on departmental or college websites; mission and vision statements that highlight the importance of program inclusivity; departmental emphases on community engagement and collaboration; new faculty searches focused upon design justice; faculty research that explores or involves the built environment of underrepresented peoples; the diversity of the faculty, staff, and student body; equity-driven student work (such as design-build projects for those experiencing homelessness); and events, activities, and research featuring social and cultural inclusiveness, including recent guest lectures on design justice topics. Taken together, these developments suggest that the gap is shrinking between professional, institutional, and organizational proclamations of equity and justice and their appearance in the classroom, the studio, and the community. They also offer promise that architectural education is accelerating towards greater equity—perhaps at a greater clip than ever before.

It is easy to be less sanguine, however. Not quite two years removed from the tumultuous events of 2020, it may be premature to evaluate whether accredited architecture programs are acting upon the various equity and justice statements from the profession's various governing bodies, as it may be too early to determine whether any institution of higher learning is truly acting upon its written declarations (Bartlett 2021). Moreover, noting a commitment to equity and justice from an online search alone is not suggestive of permanence or impact—either for architectural education or society at large. More time must pass, more research must be conducted, and, importantly, equity and justice in architectural education must ultimately manifest itself in the lives of marginalized people and communities in tangible ways.

1.1 The Rise of Spatial Justice in Architectural Education

And yet the number of statements, initiatives, and projects coalescing around equity and justice appears to signal a shift or moment, even if introducing these issues into design education is not historically new. Social, racial, class, and gender inequities have long been broadly theorized in philosophy, literary criticism, ethnic studies, critical pedagogy, gender studies, and post-colonial studies; one notes the work of Roland Barthes, Homi Bhabha, Judith Butler, Frantz Fanon, Michel Foucault, Paolo Freire, Henry Louis Gates Jr., bell hooks, Ibram X. Kendi, Edward Said, Gayatri Spivak, and Cornel West. Scholarship that broadly examined or exposed issues of equity or, at least, systemic *inequities* in the world of the built and natural environment began to emerge in the 1990s and into the 2000s with the work of Arturo Escobar in anthropology; William Cronon, Patricia Limerick, and Richard White in American and environmental history; Julian Agyeman, Leonie Sandercock and Donald Schön in urban and environmental studies and planning; and Kathryn Anthony, Dolores Hayden, Dianne Harris, Dell Upton, and Mabel Wilson in the history, theory, and criticism of architecture, architectural practice, and architectural education.

In recent years, Sasha Costanza-Chock has emerged as a leading voice for studies of design injustice in a gendered world where algorithms do not accommodate for non-binary, gender neutral people (Costanza-Chock, 2021); Adrienne Brown, Sharon Sutton, Amber Wiley, and Craig Wilkins are among the prominent voices exposing design injustice facing African Americans, past and present. Even the notion of *de-colonization* now seems almost commonplace; following upon Eve Tuck and K. Wayne Yang's 2012 call to recognize decolonization as *action*, not metaphor (Tuck and Yang 2012), land acknowledgment statements are ubiquitous and—though critics are quick to recognize that such statements do little to break down systems of oppression—the AIA is entertaining the questions about how one might begin to *decolonize* the built environment (D'Aprile 2021; Flynn 2021). Theories of racial and social injustice in the built environment are extending beyond academia, as well: Richard Rothstein's 2017 book *The Color of Law: A Forgotten History of How Our Government Segregated America*, which examines the federal government's role in racial segregation and redlining practices beginning in the 1930s, won the Hillman Prize for literature and then spent more than seven months on the *New York Times* bestseller list (Mayes, Tierney, and Keating 2020). Ta-Nehisi's Coates' 2014 "The Case for Reparations" in *The Atlantic* earlier helped bring these issues into the mainstream (Coates 2014).

The pace towards equity and justice in architectural education is accelerating. Shortly after the murder of George Floyd, over 150 faculty members, students, architects, landscape architects, artists, planners, and community activists from around the country formed the "Dark Matter University" to affect "immediate change toward an anti-racist model of design education and practice." They took action by attempting to reimagine architectural education by collaborating to teach several "anti-racist" and interdisciplinary studios, seminars, and introductory courses via Zoom beginning in fall of 2020 (Dark Matter University 2021). The summer 2020 publication of Irene Cheng, Charles L. Davis II, and Mabel Wilson's anthology *Race and Modern Architecture: A Critical History from the Enlightenment to the Present*, meanwhile, was timely, if not prescient: scholars and theorists of architecture will increasingly need to grapple with architecture's rise within the sphere of white supremacy (Cheng, Davis, and Wilson 2020). Such issues were underscored in October of 2020 when Dianne Harris, Louis Nelson and Damon Rich spoke to *Architectural Record* in a "conversation" about race and architecture and noted architectural education's long-standing ties to whiteness and power (*Architectural Record* 2020). In a March 2021 article for *Platform: Provocative, Timely, Diverse*, William Littmann, an architectural historian at the California College of the Arts, wrote about how he "decolonized" his syllabus for a History of Interiors course (Littmann 2021). Online Zoom discussions, roundtables, and seminars on race and social justice in design have become regular features of our growing virtual landscape.

Keeping track of the scholarship on equity and justice in the built environment cannot be easy—nor should it be. A “Google” search for equity and justice in architectural education in mid-January of 2022, for example, revealed more than 18 million links leading to articles, videos, podcasts, bibliographies, and blogs, many of which seem to have appeared since the events of 2020. There is a booklist on race and diversity maintained by the Society of Architectural Historians; an annotated “Racial and Social Equity Resources List” compiled by the Historic Preservation program at the University of Pennsylvania’s Weitzman School of Design; and a list of resources on race and architecture put together by Mario Gooden and Mabel Wilson for the Architectural League of New York—excellent repositories, all, though likely already out of date by the time this paper is published. The rising volume of scholarship lends further credence to the awareness of systemic inequity and injustice in the landscape of architectural education.

National architectural organizations are also reinforcing a larger social consciousness towards racial and social equity in ways that directly affect architectural education—not all of which emerged following the summer of 2020 (Associated Collegiate Schools of Architecture 2020a). Beyond statements of solidarity and empathy for marginalized peoples are studies with data and suggestions for best practices. Kendall Nicholson, ACSA’s director of research and information, for example, undertook studies of six underrepresented racial or cultural groups in architecture between 2020 and 2021 in the “Where Are My People?” research series (Nicholson 2020-21); and in 2021, nine deans from ACSA member institutions launched the “Dean’s Equity and Inclusion Initiative” to help emerging scholars advance “spatial justice, equity and inclusion.” (Guimapang 2021). Importantly, too, the most recent edition of the NAAB Conditions for Accreditation, adopted in February 2020, incorporates “Social Equity and Inclusion” as a category architectural programs must fulfill—building upon earlier criteria for creating a positive, welcoming, and accessible environment for a diversity of people. The new category appears to encourage programs to report upon their commitment to equity and inclusion in environments, policies, words, and actions and asks them to demonstrate how they have deepened student understanding of diverse cultures into equitable built environments. Under a section labeled “shared values,” the guidelines state that architects “seek fairness, diversity, and social justice in the profession and in society and support a range of pathways for students seeking access to an architecture education” (National Architectural Accrediting Board 2020, 1).

Those pathways, it seems, continue to widen. “Students are demanding a different kind of [design] education,” said Gabrielle Bullock, principal and director of global diversity at Perkins and Will in an October 2021 podcast hosted by *Architect* magazine—one where students are learning about “all people and not just from one point of view.” (Lau 2021, 12:45). My own graduate seminar in Discrimination and Design would seem to corroborate Bullock’s impression: a handful of students wondered why many of the issues we raised had not been more explicitly addressed in their undergraduate curriculum—or even during their secondary education. In both fall of 2020 and fall of 2021, several students expressed the desire that the course would continue. Architecture firms have joined the movement as well: many of them offered statements of support after the death of George Floyd, and many of the larger firms, including Gensler, SOM, and Safdie Architects—have hired diversity or social responsibility managers (Cogley 2021). Are architecture programs, schools, and departments in higher education stepping up?

2.0 METHODOLOGY

To begin a more comprehensive exploration of this issue, in the fall of 2021, I selected thirty (30) NAAB-accredited architecture programs and examined websites to assess their commitment to equity and justice. The research incorporated a list on the ASCA website, initiated in 2020, where faculty at ACSA member institutions can self-report built environment-related courses focused around race, equity, and social justice which, as of January 4, 2022, included 188 courses from 53 NAAB-accredited institutions (Associated Collegiate Schools of Architecture 2022). To provide as broad a scope as possible within a small sample size, five (5) programs were chosen in each of NAAB’s six accreditation regions: West, West Central, East Central, Gulf, Mid Atlantic, and North Atlantic. These programs were drawn from colleges and universities both public and private, including several major land-grant institutions; two Historically Black Colleges and Universities (HBCUs); two departments within technology-oriented colleges; two programs at religiously-affiliated universities; and three programs within colleges or institutes specializing in architecture, art, and/or design.² I was not restrictive about which accredited degree was offered or when accreditation had been granted: programs awarded either the Master of Architecture degree (M.Arch.), the Bachelor of Architecture degree (B.Arch.)—or both. Of course, a more comprehensive study would need to include all NAAB-accredited institutions, which number 136 as of April 2021.³ This project surveyed a little under one-fourth of all accredited schools.

In an attempt to *quantify* whether architecture programs were incorporating a rather unquantifiable matter (equity and justice), I browsed websites to see what the programs (or colleges) chose to highlight and ranked each program as either “high,” “middle,” or “low.” Programs ranked as “high,” for example, were those that embraced departmental initiatives about design justice; offered statements of empathy for underrepresented groups; featured dean, director, or chairs’ messages declaring justice commitments to equity and justice; highlighted student projects or departmental organizations about design justice; demonstrated some effort to increase diversity among students, faculty, and staff; discussed faculty or student research initiatives on social justice-related issues; included courses that advanced issues of equity and justice in some fashion; had a National Organization of Minority Architects Students (NOMAS) chapter; and listed guest lectures or workshops regarding equity and justice in the built environment. Programs neither were

required to provide evidence of all of the above to achieve a “high” ranking, nor would an example of equity and justice necessarily be restricted only to the above list. Yet “high” programs generally had to demonstrate more than two instances of equity and justice. Most importantly, programs, schools, and departments needed to make it evident that equity and justice were integral to their culture—or that they desired to make them so.

Programs that ranked in the “middle” tier were those whose commitment to equity and justice in design was less apparent, yet still present. In these cases, an attention to equity and justice might be discerned within otherwise difficult-to-find mission or vision statements; gleaned through projects or research centers involved predominantly in community engagement or environmental justice (most of which seemed to have been created well before 2020); or where statements of equity (such as “DEI” statements or land acknowledgments), while suggesting a commitment to equity and justice, did not seem substantiated by actual projects, initiatives, courses, or research. Programs ranked as “low” were those where I found no statement or project(s) with an emphasis on equity and justice.

There is, however, a significant margin of error in this preliminary study.⁴ Beyond the relatively small sample size, that a departmental website fails to make apparent a commitment to equity and justice should not be taken to mean that *therefore* those principles are not crucial to program mission or values. Indeed, it is possible that such commitments appeared online at one point but have since been removed as the program moves toward action. Furthermore, some programs may have approved, embarked upon, or are currently sponsoring equity and justice initiatives, coursework, or curriculum revisions but have not updated their websites accordingly (circumstances which may reflect budgetary constraints, staffing shortages, or administrative or faculty priorities). This information could be revealed through interviews with administrators and/or key faculty involved in equity and justice initiatives; more information about how (or if) equity and justice is manifesting itself in coursework also could emerge via questionnaires distributed to students.⁵

Furthermore, departments and colleges of design may have long committed to equity and justice and perhaps feel less urgency about crafting statements of solidarity or beginning new initiatives focused upon the architecture of marginalized peoples, particularly with concerns about COVID-19 affecting in-person initiatives or instruction. It is further possible that those programs judged highly for equity and justice may not be producing “results” in the studio, classroom, or community. Certainly, growing the diversity of students, faculty, and staff from underrepresented populations shows a program’s awareness of equity and justice, but will the program empower marginalized populations through its curricula, research, or community engagement?⁶ The potential for such quantitative inaccuracy does not invalidate a qualitative purpose: to identify a rising consciousness in the world of architectural education that demonstrates a commitment—or at least a rising attention—to matters of equity and justice.

3.0 PRELIMINARY FINDINGS

Of the thirty (30) NAAB-accredited programs examined for this study, twenty-five (25) either highlighted or included efforts around equity and justice. Fourteen (14) of these programs scored in the highest tier, where it was apparent that equity and justice were cornerstones of their pedagogical philosophy. This was evident, for example, through prominently situated statements or letters regarding George Floyd and the department’s promise to fight for justice (as at Clemson University, University of Detroit Mercy, and Princeton University); where educating underrepresented students was fundamental to departmental missions (as at Morgan State University and Tuskegee University); and where multiple courses were listed on the ACSA “Equity Course List” (as at the California College of the Arts, the University of Louisiana-Lafayette, North Carolina State University, The Ohio State University, Pennsylvania State University, Pratt Institute, and Washington University in St. Louis).

Among the more comprehensive models for equity and justice in the built environment in this study were demonstrated by college or architecture program websites for North Carolina State University, the University of Florida, Pratt Institute, California College of the Arts, and the College of Architecture and Planning (CAP) at the University of Colorado Denver. As one example, CAP—a college that includes architecture, urban planning, and landscape architecture—prominently features a detailed, multi-pronged effort centered on equity and justice demonstrated through working groups; all-college gatherings; mentorship opportunities; affiliated organizations; syllabi; and accountability through performance evaluations. That such efforts are not temporary is underscored by updates posted on October 19, 2021 (College of Architecture and Planning, University of Colorado Denver, n.d.). At North Carolina State University, a statement on “Justice, Equity, Diversity, and Inclusion” is listed just below “faculty and staff” on the home page for the School of Architecture; its “Research and Engagement” tab reveals the “Affordable Housing and Sustainable Communities” initiative as well as the “Public Interest Design Incubator.” The university’s College of Design page, under its “diversity” tab, includes its own detailed process of fostering an inclusive environment for its eight degree-granting concentrations which includes specific statements regarding Black Lives Matter and Ancestral Lands (College of Design, North Carolina State University, n.d.). Three North Carolina State courses are also listed on the ACSA Equity Course List, including a jointly taught, co-listed course with the intriguing title of “DIY Cartography: Equity and the Built Environment.” How these endeavors manifest themselves within student engagement projects or the accomplishments of graduates remains undetermined, but the importance of equity and justice at these institutions—and the proposed actions around them—are readily apparent.

Eleven (11) of the programs scored in the middle tier. Typically, websites for those programs offered just one or two equity and justice statements or initiatives, but they were not as evident as those within the top tier. Such initiatives might include a DEI statement, either as a stand-alone example or sprinkled into the program mission or vision; a community engagement component; an example of faculty research on an equity and justice-related topic, or a recent lecture regarding social justice in the built environment. Only five (5) programs in this study had little or no information on equity and justice. Perhaps such issues were embedded within university-level documents or would emerge through discussions with individual faculty members or students, but nothing was revealed through a preliminary examination of online information.

Programs that fell into the middle and low categories are difficult to interpret. It is certainly possible that these programs are doing far more towards equity and justice than what is mentioned online—and have been doing so for several years. Alternatively, these programs may be deeply committed to equity and justice, yet perhaps with an eye towards recruitment do not wish to draw attention away from their professionally-oriented student preparation; their emphasis on a “hands-on” education, or their steadfast belief in the craft and beauty of design. This is understandable: architecture programs may be busy trying to enact that change on the ground instead of prioritizing the *promotion* of that change. Furthermore, change at the program level is also challenging and often slow: curricular shifts, for example, typically require scores of meetings and layers of bureaucracy, while change at the individual course level requires the time of faculty members to shift subjects and often rethink modes of delivery. But the preliminary findings suggest that most programs, on the whole, have been active in this regard.

4.0 DISCRIMINATION AND DESIGN

Although not a formal part of this study, one such example is the Discrimination and Design course, which I taught in fall of 2020 and 2021 as a flipped-classroom graduate seminar required for students in architecture and interior design at Washington State University. I offer it here to illustrate one approach for beginning to embed a commitment to equity and justice within a curriculum and because it generated my interest in this larger investigation. The course content did not generate the specific criteria for this research project, yet it taught me that a commitment to equity and justice must be sustained through coursework, research, lectures, and activities throughout the program year after year. Ultimately, this commitment must manifest itself in tangible ways, especially if the topics, circumstances, or issues discussed are not uplifting and especially if students feel powerless to affect what is rooted in systemic injustice, politics, or developer-driven capital—which many of them did.

Discrimination and Design recast an existing required graduate course, which had for some years been taught as an extension of topics covered in the architecture graduate studio. Yet George Floyd’s murder and the nationwide protests against systemic injustice unfolded as I was crafting the syllabus. This inspired a fall 2020 shift to a discussion-oriented course focused on spatial inequities organized around six topics divided into two-week segments (or fortnights): Black Lives Matter, gender and sexuality, the pandemic, borders, climate, and monuments (the latter of which focused upon the recent controversies roiling around monuments to the confederacy and to colonialism). For fall 2021, issues about gentrification and accessibility for people with disabilities were more specifically integrated into the class content, though questions of equity and justice (and *inequity* and *injustice*) remained interwoven throughout.

I created the course, in part, to connect contemporary issues of racism (cultural and environmental), sexism, classism, and ableism to design—past and present. Assigned articles, videos, podcasts and online discussions either directly concerned design issues or were those where application to the built environment was clear. Students (25 in fall 2020; 29 in fall 2021) were active participants: at several points, they were encouraged to collaborate and lead discussion; at times, too, they were also asked to select material for the rest of the class. I avoided the traditional “sage on the stage” lectures and, though there were times that conversation had to be steered back to the topics at hand, more often than not the classes participated in what former ACSA President Rashida Ng implored architectural educators to do in 2019; that is, to ask of educators what they ask of students: “to be challenged, to take risks, to adapt, and to navigate the uncertainty and excitement that change undoubtedly brings” (Ng 2019). On several occasions, the instructor learned from the students; indeed, two articles cited for this paper are those to which they alerted the instructor—not the other way around. While not everyone participated regularly in the verbal class discussion, on the whole, students were willing to engage in challenging topics through online posts and student-led activities—including miniature field trips around campus, during class time, to address issues of equity and justice through physical examples. All students participated in the online conversation (indeed, teams of students were asked to *create* discussion prompts for the rest of the class, and for the instructor), and their comments, on the whole, demonstrated a recognition of bias, cultural appropriation, racism, and patriarchy in design; an acceptance of designers’ complicity in sustaining systemic injustice through practice; an acknowledgement of the role of architectural education in upholding western modes of thought; and a general understanding that social, cultural, and economic inequalities are both produced and reproduced by the profession.⁷

That forty-nine (49) total graduate students have enrolled in the Discrimination and Design course over a two-year period (forty-two of whom received, or likely will receive, a Master of Architecture degree) should not be interpreted to suggest that issues of equity and justice are yet integral to the architecture program at Washington State University; indeed, no single course is likely to have that kind of an impact in any program. One cannot claim that the issues

resonated with all students—particularly those students already resolute in their beliefs about the capability of design in shaping culture or those otherwise uninterested in designing and building for marginalized people or communities. Moreover, introducing equity and justice in design at the graduate level may be too late: if it is not considered in foundational classes, students may interpret them as less vital to their education. Finally, the idea that a single course on equity and justice is needed at all might be suggestive that such issues are *not* covered elsewhere in the curriculum. As Rahul Mehrotra, chair of the Department of Urban Planning and Design at Harvard University contends, it is not about creating a new, required class in the curriculum, but “a matter of emphasizing core *issues* (italics mine) like race and ethnicity, economic justice, climate change, and public health and embedding them in every course” (Bucknell 2020).

CONCLUSION

Far more must be accomplished if, as the ACSA Board of Directors reminded us in April 2021, it remains vital in architecture and architectural education to “remedy the systemic embrace of historically White and Eurocentric theories, design aesthetics, and processes”—no matter the progress that has been achieved (Associated Collegiate Schools of Architecture 2021). Yet a class focused upon discrimination and design is, at least, a start—just as this preliminary study suggests that architecture programs are alerting students to architecture’s historic role in the design and construction of *injustice* while increasingly making equity and justice initiatives central to their missions. It would seem, then, that equity and justice—as with climate change and the health, safety, and welfare of the built environment—must not collect dust on the proverbial shelf of architectural education. If architects should be aware of the potentially discriminatory effects of their work, such issues must manifest themselves throughout an architectural curriculum. And, importantly, they must be embedded within the community, the region, and the world.

ACKNOWLEDGEMENTS

The author wishes to thank the anonymous reviewers who understood that definitive outcomes may not be available at the early stage of this research—and yet recognized the overall importance of trying to assess equity and justice in architectural pedagogy. Gratitude is also extended to all students in my Discrimination and Design courses. They have been open to discussing challenging issues in the classroom and their spirit may inspire future program changes and curricular shifts.

REFERENCES

- American Institute of Architects. 2020. “Everyone Deserves Universal Respect and Dignity.” *AIA.org*, May 30, 2020. <https://www.aia.org/press-releases/6299362-everyone-deserves-universal-respect-and-hu>.
- Anthony, Kathryn H. 2002. “Designing for Diversity: Implications for Architectural Education in the Twenty-First Century.” *Journal of Architectural Education* 55, no. 4 (May 2002): 257-67.
- Architect Staff. 2020. “Organizations Respond to the Unrest in the Wake of the Killing of George Floyd in Minneapolis,” *Architect* (magazine), June 5, 2020. https://www.architectmagazine.com/practice/organizations-respond-to-the-unrest-in-the-wake-of-the-killing-of-george-floyd-in-minneapolis_o.
- Architectural League New York. n.d. “Statement and Resources on Race and Architecture.” Accessed October 12, 2021. <https://archleague.org/article/the-architectural-leagues-statement-on-racial-justice/>.
- Architectural Record*. 2020. “Architecture and Racism/On the Record: A Conversation.” *Architectural Record* (November): 34-38.
- Associated Collegiate Schools of Architecture. 2022. “Courses Addressing Justice, Equity, Diversity, and Inclusion in the Built Environment.” Last update: January 4, 2022. <https://www.acsa-arch.org/resources/data-resources/acsa-architecture-and-equity-course-list/>.
- _____. 2020a. “Developing Policies and Shifting Operations for Equity, Diversity and Inclusion.” Samia Rab Kirchner, moderator. June 25, 2020. Video. <https://www.youtube.com/watch?v=ISYP3RHbRSc&t=5s>.
- _____. 2020b. “Addressing Race and Equity in Architectural Education: Beginning the Conversation.” June 18, 2020. Video. <https://www.youtube.com/watch?v=0kxSSByVTcg>.
- _____. n.d. “ACSA Racial Equity Statement.” Accessed October 6, 2021. <https://www.acsa-arch.org/acsa-board-of-directors-racial-equity-statement/>.
- Bartlett, Tom. 2021. “The Antiracist College.” *Chronicle of Higher Education*. February 15, 2021. <https://www.chronicle.com/article/the-antiracist-college>
- Bucknell, Alice. 2020. “Architecture, Design, Action: Rahul Mehrotra on Dismantling Systemic Racism in Pedagogy and Practice,” *Harvard University Graduate School of Design News*, Aug. 12, 2020. <https://www.gsd.harvard.edu/2020/08/architecture-design-action-rahul-mehrotra-on-dismantling-systemic-racism-in-pedagogy-and-practice/>.
- Cheng, Irene, Charles L. Davis II, and Mabel Wilson, eds. 2020. *Race and Modern Architecture: A Critical History from the Enlightenment to the Present*. Pittsburgh: University of Pittsburgh Press.
- Coates, Ta-Nehisi. 2014. “The Case for Reparations.” *The Atlantic*, June 2014. <https://www.theatlantic.com/magazine/archive/2014/06/the-case-for-reparations/361631/>.
- Cogley, Bridget. 2021. “Report Card: How Are Firms Grappling with Racial Justice?” *Architectural Record*, May 25, 2021. <https://www.architecturalrecord.com/articles/15140-report-card-how-are-firms-grappling-with-racial-justice>.

- College of Architecture and Planning, University of Colorado Denver. n.d. "Justice, Equity, Diversity, and Inclusion." Accessed October 24, 2021. <https://architectureandplanning.ucdenver.edu/architecture/CAP/Diversity-and-Inclusion>.
- College of Design, North Carolina State University, n.d. "Diversity." Accessed January 12, 2022. <https://design.ncsu.edu/about/diversity/>
- School of Architecture, College of Design, North Carolina State University, n.d. "Justice, Equity, Diversity, and Inclusion." <https://design.ncsu.edu/architecture/diversity-equity/>
- Costanza-Chock, Sasha. 2018. "Design Justice, A.I., and Escape from the Matrix of Domination," (Parts 1-3). *Journal of Design and Science* (2018). <https://jods.mitpress.mit.edu/pub/costanza-chock/release/4>,
- Cripps, Christopher. 2004. "Architecture, Race, Identity, and Multiculturalism: A Radical 'White' Perspective." *Social Identities* 10, no. 4 (2004): 469-81.
- D'Aprile, Mariana. 2021. "Architecture's Colonial Reckoning." *The Architect's Newspaper*, April 13, 2021. <https://www.archpaper.com/2021/04/calls-to-decolonize-architecture-have-been-gaining-support-what-does-this-mean/>.
- Dark Matter University. 2021. "Dark Matter University: Lessons in Anti-Racist Design Pedagogy." May 26, 2021. Video. <https://www.youtube.com/watch?v=3KBi0JkI7WE>.
- Flynn, Katherine. 2021. "How Can We Decolonize Architecture?" *AIA Future*, June 11, 2021. https://www.architectmagazine.com/aia-architect/aiafuture/how-can-we-decolonize-architecture_o.
- Guimapang, Katherine. 2021. "New ACSA President Robert Alexander González pushes for DEI in higher education and shares the importance of community colleges." *Archinet*, July 2, 2021. <https://archinect.com/news/article/150272091/new-acsa-president-robert-alexander-gonz-lez-pushes-for-dei-in-higher-education-and-shares-the-importance-of-community-colleges>.
- Hammond, J.W., Sara E. Brownell, Nita A. Kedharnath, Susan J. Cheng, and W. Carson Byrd. 2021. "Why the Term 'JEDI' is Problematic for Describing Programs That Promote Justice, Equity, Diversity and Inclusion," *Scientific American*, Sept. 23, 2021. <https://www.scientificamerican.com/article/why-the-term-jedi-is-problematic-for-describing-programs-that-promote-justice-equity-diversity-and-inclusion/>.
- Historic Preservation, Weitzman School of Design, University of Pennsylvania. n.d. "Racial and Social Equity Resources List." Accessed September 15, 2021. <https://www.design.upenn.edu/historic-preservation/racial-and-social-equity-resources-list>.
- Lau, Wanda. 2021. "What Does DEI Have to do with Architecture?" *Architect*, Oct. 4, 2021. Podcast, 12:45. https://www.architectmagazine.com/practice/what-does-dei-have-to-do-with-architecture_o.
- Littmann, William. 2021. "How I Found the Courage to Decolonize My Syllabus." *Platform: Provocative, Timely, Diverse*, March 1, 2017. <https://www.platformspace.net/home/how-i-found-the-courage-to-decolonize-my-syllabus>.
- Mayes, Brittany Renee, Lauren Tierney, and Dan Keating. 2020. "Demand for Anti-Racist Literature is Up. These Black Bookstore-Owners Hope It Lasts." *Washington Post*, July 2, 2020. <https://www.washingtonpost.com/graphics/2020/business/black-owned-bookstores-anti-racist-literature/>.
- National Architectural Accrediting Board. 2020. "Conditions for Accreditation 2020 Edition." February 10, 2020. _____ . 2014. "2014 Conditions for Accreditation." July 18, 2014. _____ . 2009. "2009 Conditions for Accreditation." The National Architectural Accrediting Board, Inc., July 10, 2009.
- National Council of Architectural Registration Boards. 2020. "NCARB's Commitment to Combating Racism." June 5, 2020. <https://www.ncarb.org/press/ncarb-commitment-to-combating-racism>
- Ng, Rashida. 2019. "What Will It Take? Reflections on Diversity, Equity, and Inclusion in Architectural Education." *Journal of Architectural Education* 73, no. 2 (October).
- Nicholson, Kendall. n.d. "Where Are My People?" Data Resources, Associated Collegiate Schools of Architecture. Accessed Nov. 3, 2021. <https://www.acsa-arch.org/resources/data-resources/>.
- Richards, William. 2021. "Justice's Three Jobs." *Architect*, October 6, 2021. https://www.architectmagazine.com/aia-architect/aiafeature/justices-three-jobs_o.
- Society of Architectural Historians. n.d. "SAH Special Booklist: Race and Diversity." Accessed August 22, 2021. https://www.sah.org/docs/default-source/booklists/2020-race-and-diversity-booklist.pdf?sfvrsn=956e249b_2.
- Stewart, Dafina-Lazarus. 2017. "Language of Appeasement." *Inside Higher Ed*, March 30, 2017. <https://www.insidehighered.com/views/2017/03/30/colleges-need-language-shift-not-one-you-think-essay>.
- Tuck, Eve and K. Wayne Yang. 2012. "Decolonization is not a Metaphor." *Decolonization: Indigeneity, Education & Society*, 1, no. 1 (2012): 1-40.

ENDNOTES

¹ The terms “equity” and “justice” are used interchangeably in this essay to refer to a solidarity with marginalized peoples; a commitment to understand, teach, and integrate underrepresented perspectives into architectural education; and an effort to expose the systemic inequities of the built environment—past and present. I am attempting to avoid the term “diversity,” as it is too often refers to cultural *representation*; that is, the *numbers* or *percentages* of cultures, genders, or sexualities from underrepresented populations. In this quantitative context, the term “diversity” fails to account for whether underrepresented populations are actually permitted to participate in a larger project to dismantle a western-based pedagogical paradigm (Associated Collegiate Schools of Architecture 2020b; Richards 2021; Stewart 2017). Similarly, I have avoided the use of the increasingly popular acronym “JEDI” (Justice, Equity, Diversity, Inclusion), given its associative connections with the “Jedi Knights” of the Star Wars galaxy of motion pictures. The Jedi Knights themselves have potentially problematic associations that do not always convey notions of equity and justice (Hammond, et. al. 2021).

² The programs under consideration in this preliminary study are, in alphabetical order, at the following institutions: Arizona State University (M.Arch.), California College of the Arts (B.Arch./M.Arch.), Clemson University (M.Arch.), Dunwoody College of Technology (B.Arch.), Judson University (M.Arch.), Montana State University (M.Arch.), Morgan State University (M.Arch.), NewSchool of Architecture and Design (B.Arch./M.Arch.), North Carolina State University (B.Arch./M.Arch.), North Dakota State University (M.Arch.), Northeastern University (M.Arch.), Ohio State University (M.Arch.), Pennsylvania State University (B.Arch./M.Arch.), Pratt Institute (B.Arch., M.Arch.), Princeton University (M.Arch.), SUNY College of Technology at Alfred State (B.Arch.), Tuskegee University (B.Arch.), University of Arkansas (B.Arch.), University of Colorado Denver (M.Arch.), University of Detroit Mercy (M.Arch.), University of the District of Columbia (M.Arch.), University of Florida (M.Arch.), University of Kentucky (M.Arch.), University of Louisiana-Lafayette (M.Arch.), University of Maine at Augusta (B.Arch.), University of Memphis (M.Arch.), University of Miami (M.Arch.), University of Nebraska (M.Arch.), University of Texas at Arlington (M.Arch.), Washington University in St. Louis (M.Arch.).

³ This number does not include those programs seeking accreditation. For the complete list of accredited architecture programs, see: <https://www.naab.org/accredited-programs/accredited-programs/>.

⁴ Should this project expand to include more programs over time, one or more tiers may need to be added to those currently designated as “high,” “middle,” and “low,” for one finds degrees of difference between programs placed in all categories. For example, while no program in the “middle” tier was judged to demonstrate that equity and justice were integral to their culture, some of them featured some equity and justice initiatives suggestive of an emerging culture and thus meriting a placement on the higher end of the middle tier. Meanwhile, other programs ranked in the middle tier included just one apparent initiative from this preliminary study, indicating less commitment to equity and justice and thus landing on the lower end of the middle tier. An expanded study, as proposed by a peer reviewer of this paper, may be better served by placing programs into four or more categories, such as “high,” “good,” “limited,” and “poor.”

⁵ These methods (or versions of them) could be a part of a more comprehensive, or later phase, of this study.

⁶ The diversity of students, faculty, and staff in a program is difficult to determine from a website search. In this study, visible web-based program statements speaking to increased diversity in whatever form (race, gender, sexuality, for example) was at least acknowledged as an attempt to consider its importance, meriting placement at least in the “middle” tier. The value of a broad mix of faculty and students in a program is discussed in some detail by Kathryn Anthony in the *Journal of Architectural Education* (Anthony 2002) and affirmed by NAAB in section 5.5 (Social Equity, Diversity, and Inclusion) in its conditions for accreditation (National Architectural Accrediting Board 2020, 8).

⁷ This awareness can be evinced by course evaluations, student comments on the online course discussion board, and instructor recollection of weekly, in-person class discussions for fall 2021. Studies that posit the effectiveness of active learning strategies in the classroom are widespread; whether they are more effective than traditional lectures for equity and social justice in architecture remains to be seen.

Critical Pedagogy and Public Interest Design: Transforming Architecture Design Education for Social Justice

Erika Zekos¹

¹University of Massachusetts Amherst, Amherst, MA

ABSTRACT: There is a loud call for architectural education to become more diverse and inclusive, especially considering the strength and impact of the Black Lives Matter movement and the global movement for racial justice. As a profession responsible for a significant percentage of our built environment, architecture needs to better reflect the needs and desires of the people it serves, and to include more diverse designers and community members in the design process. Higher education is an important gateway, because architects must earn a professional degree to become licensed practitioners. However, it is not enough to simply change the statistics by recruiting more students of color to architecture schools. Once there, students must be met with a pedagogy that reflects their identities and the needs of their communities. Our educational practice must be informed by the very social justice movements it aims to embrace. This paper, informed by literature review and a case study of a university public interest design studio course, will share the ways in which architecture education has historically contributed to racial injustice and focus on how the education of future architects can be shifted to engage students in a design praxis informed by critical pedagogy. Architecture education informed by critical pedagogy is a problem-solving approach to teaching and learning that actively strives to identify and transform power relationships that lead to oppression by seeing design problems as part of larger systems, and to develop concepts into action through design. This paper challenges us to recognize that architects have a role in perpetuating or dismantling of oppression and that architecture education can transform to better serve a diverse student body and ultimately, diverse and equitable communities.

KEYWORDS: critical pedagogy, public interest design, curriculum theory, social justice

INTRODUCTION

The architecture community's recent surge of action to become more diverse and inclusive is encouraging. However, for the profession to truly change, architecture design education must deeply transform to educate about social justice and critique its own reification of injustice and oppression through a critical pedagogy framework.

Architecture education has contributed to an unjust society by not providing an accessible and welcoming space for students of color, disabled students, and other minoritized identities to engage, and by developing students who are not critical of their own complicity in the social systems of oppression. As a profession responsible for a significant percentage of our built environment; architecture needs to transform to better reflect the needs and desires of the communities it serves, and to include more diverse designers and community members in the design process. Higher education is a critical gateway, because architects must earn a professional degree to become licensed practitioners. According to The National Council of Architectural Registration Boards (NCARB), the nonprofit organization that administers programs for architects pursuing licensure, only 2 percent of all licensed architects are Black. In fact, all racial and ethnic diversity is reflected in just 11 percent of the 116,000 professional architects in the United States (Sitz, 2020).

This paper shares some of the ways in which architecture education has historically contributed to injustice in higher education, and reviews literature from established peer-reviewed journals and conferences of architecture education and history for discussion about the integration of the social theory of critical pedagogy in architecture education. The paper then proposes employing a critical pedagogy-informed public interest design praxis to engage students in a critique of the social forces that perpetuate disproportionate harm of communities of color, minoritized gender identities, the socioeconomically disadvantaged, and disabled. It invites a commitment to social justice, to transform architecture education to better serve a diverse student body and ultimately, diverse communities.

1.0 Architectural education and spatial justice

Architectural educators have been struggling to address social justice issues for decades. Since Whitney M. Young Jr.'s call to action in 1968, progress has been made, in particular with the emergence of public interest design in both practice and academia in the 1970s, and in the early 2000s with the development of the Social Economic Environmental

Design (SEED) Network and Public Architecture's 1% program. The nation's reckoning with racial injustice propelled by rise of the Black Lives Matter movement has offered a newly invigorated opportunity to interrogate the responsibility of higher education to social justice and many educators and professional organizations have contributed to a resurgence of commitments and changes. Professional organizations like the Association of Collegiate Schools of Architecture (ACSA), National Organization of Minority Architects (NOMA), and American Institute of Architects (AIA) have hosted numerous presentations, conferences, and workshops focused on these issues. The writings of many Black architect-scholars such as Mabel O. Wilson, Sharron Egretta Sutton, Michael Ford, Sekou Cooke, and others have linked contemporary issues of race and architecture to historical foundations of racial injustice for a larger audience.

Historical evidence of architecture's complicity with institutional oppression can be seen in the discriminatory practices that have not valued differently abled, socioeconomically disadvantaged, and non-white people equally. These practices have prevented investment in transportation infrastructure, schools, and housing, as well as in policies such as redlining and the destruction of neighborhoods for high profit properties that displace long-standing working-class populations (urban renewal and gentrification). Architects maintain systems of oppression through the design of for-profit prisons and substandard social housing (Sutton, 2018, Rothstein, 2017). The invisibility of the physically, economically, and racially disadvantaged, whether due to architects' willing neglect or ignorance of their needs, perpetuates oppression that further harms the poor and people of color with crumbling infrastructure, civic buildings, and homes.

Yet, for too long, architects have considered themselves neutral (or at least not complicit) in the systems that contribute to oppression by maintaining that good design serves everyone, by evaluating only the technical performance and aesthetic qualities to determine a building's success, and by deflecting responsibility for social justice to the paying customer. But many practitioners have been confronting the challenges faced by society in their work and recognizing that buildings impact social systems just as they change physical environments (Anderson, 2014).

Architectural education is not neutral either. There are many ways in which the educational system contributes to ongoing systemic oppression, and this is evidenced most plainly by who is in the room. The limited number of students and faculty of color in architecture degree programs is no surprise given the barriers to college entry, including, but not limited to the high cost of higher education. National Center for Education Statistics (NCES) data show that in 2013, 66 percent of bachelor's degree earners in architecture were white, 6 percent were Black, 15 percent were Hispanic, 12 percent were Asian; and Native and Pacific Islanders had no statistical presence (Nicholson, 2014). But it is not enough to simply change the statistics by recruiting more students of color to architecture schools. Once there, students must be met with a pedagogy that reflects their identities and the needs of their communities.

2.0 Historical foundations of bias in architecture design education

In every classroom or studio someone must choose which knowledge to convey, which histories, practices, and theories are taught. These histories, practices and theories are worth noting because they affect both curriculum content and instructional methodology (Dutton, 1987; Crysler, 1995). Many of the practices seen in the contemporary architecture design studio, are still informed by those established in the 17th century at the Ecole de Beaux-Arts in France. By the end of the 19th century, the majority of American schools of architecture were following the Beaux-Arts tradition as French-educated American architects returned home to influence the development of schools of architecture in the United States (Simon, 2002).

The Beaux-Arts school of architectural education marked a professionalization of architecture and a formal split from the apprenticeship-style training of the tradecrafts. This effort was largely supported by the patronage of the wealthy and royal (Cret, 1941). In the Beaux-Arts *atelier*, the studio professor, the *patron* delivered instructional lectures and provided design critique. The predominantly male student body (Clausen, 2010) proceeded through a series of project-based competitions to design a range of building types and success, or failure was determined by the judgement of professor-critics. (Simon, 2002). The stylistic focus was on the art and architecture of western antiquity. They believed that "Roman art was the highest and final expression of architectural truth" (Cret, p. 8) and "untrained" and non-western work was considered inferior.

The contemporary architecture school studio culture owes much to the atelier model. Studios are small groups of students run by a critic, that offer design problems of increasing complexity. A dialogic process of critique frames the development of design which ends with a formal presentation of design work and judgement by a jury. While contemporary architecture school studios are not explicitly competitive, the spirit remains (Simon 2002). The majority male profession and divide of academia from the trades are also legacies of the Beaux-Arts tradition.

Architecture curricula also continue to be shaped by bodies of work produced by western cultures; by architecture from ancient Rome as championed by the Beaux-Arts, and by the modernists of the mid-20th century, a group of white European men. This canon provides the core source of precedent design projects and theories of design and practice that are taught in architecture programs today (Pozdnyakova, 2020).

2.0 CRITICAL PEDAGOGY

Critical pedagogy is a practice of education that draws upon critical theory; a philosophy that acknowledges the social, historical, and ideological forces of oppression and structures that maintain them in service to the dominant group and to the disadvantage of the subordinate (Brookfield, 2005). Critical pedagogy accepts that education systems are political. It provides a problem-solving approach to teaching and learning that actively critiques and transforms power relationships that lead to the oppression of people. It humanizes and empowers learners to recognize education's role in the reproduction of inequality and that the elimination of oppression leads to a just society for all (Freire, 2000, Aliakbari & Faraji, 2011). According to the champion of the philosophy, Brazilian educator Paulo Freire, a critical pedagogy:

- Uses generative themes to identify issues of systemic injustice relevant to students and the community.
- Engages a problem posing approach rather than the “banking model of education” (which involves the teacher depositing knowledge into student brains).
- Encourages teachers to avoid the expert mindset by creating conditions for collaboration and dialogue that blur the boundaries between knower and known.
- Honors students' lived experiences and acceptance of their own cultural backgrounds.
- Empowers students to take responsibility for their learning through dialogue, action, and reflection.

Critical Pedagogy empowers students to participate in their self-formation and to recognize the ways in which they engage with the reproduction of oppression. This means that they participate in learning about and critiquing how racism, sexism, classism, and ableism affect them and their communities. While the traditional architecture design studio is indeed a problem-solving space where students are active learners, and engage complex issues; problems of power and hegemony are rarely engaged in favor of more a formal set of conditions related to foundational design concepts, spatial environments, ergonomics, materials and tectonics, and conceptual ideas. The absence of criticality about how systems of oppression shape the educators, learners, the curriculum, and practices of the studio results in a design education that does not prepare students for a world where they are empowered to participate in liberation of society from forms of oppression. All architecture has a social impact, so the question becomes, can it impact for justice?

2.1 A critical pedagogy of architectural education

A critical pedagogy of architectural education must aim to critique the various forces of oppression that shape not only the content of academic study, but also the educational practices that form the learning experience. The architectural design studio is conceived of as a space that creates conditions for students to synthesize knowledge drawn from other fields with the creative invention of form and technical expertise demanded of the profession. However a lack of criticality about architecture students' implicit knowledge and about how new knowledge is produced (Bachman & Bachman, 2009) has helped to maintain a western perspective that excludes women and people of color. And a focus on formal development preempts incorporation of social issues in the studio dialogue. Changes are taking place in course content through wider inclusion of precedents from around the globe, references and readings from more diverse scholars, and design projects that address critical social issues. Critical pedagogy asks that students critique root causes of injustice, invites a deeper questioning of how knowledge-making is pursued, of the hidden curriculum of the studio, and critique of the expert mindset developed there.

The hidden curriculum of architectural education is evident in our teaching methods as the power dynamics of society are introduced in the studio through “unstated values, attitudes, and norms” that shape the architecture students' experience (Dutton, p. 16). The design studio is where students develop abstract concepts and complex ideas about space, materials, and human needs into architectural form through an iterative practice. While today's design studio claims to value dialogue between professor and student, elements of centuries-old practices continue to exist in the inherent hierarchy between students and faculty. Because teachers (who are majority white and male) embody knowledge and truth and convey the prestige of the profession, students shape their work to the implicit expectations of their instructor (which were themselves shaped by the same expectations). And while the studio proposes an individualized approach to design problems, much of what students learn is a common set of skills necessary for communication and representation of architectural knowledge. Individuality is not valued in favor of a “banking model” and common, undifferentiated goals for production (Crysler, 1995). For both design development and representation, a meritocratic environment values the student who works harder and longer at the design problem. This evolves into unhealthy expectations for total commitment and long hours in the studio; expectations that clearly disadvantage the student who must also work to pay tuition, commute from home, participate in extracurricular events, care for family members, or value self-care. The jury process further expands hierarchies of race, gender, and class as students and their work are objectified in a public critique that contributes to competitiveness with other students (Dutton, 1987). The competition is reinforced when work perceived to be stronger is publicly praised and work perceived to be weaker is panned. Regardless of the tone of delivery, the professor's role is to identify areas for improvement and so students are subject to an explicit hierarchical structure.

Students are introduced to examples of ancient and modern architecture in their history, theory, and design courses and produce their own creative work in these contexts. The absence of racial, ethnic, and geographic diversity in the examples shown to students reinforces the value of the western examples and serves to negate the value of non-white, non-western cultures. Another important aspect of curriculum is the design studio's reliance upon hypothetical design problems as the subject of learning. The abstraction of "users" and their sites means that studio subjects are framed as ideal examples of the human condition (Dutton, 1987) and students are framed as experts in the solution-making. This produces a gap between what students know about what they need to design and the lived experience of the inhabitants of those environments (Horner et al, 2016). In the traditional studio, the architecture student is trained to adopt an expert mindset which is prioritized over that of the eventual user of the space and imposes the institutionalized whiteness of the architecture profession on communities of all kinds. Students learn to see environments as an objective outsider, as from above. While the inhabitants of space are likely to see from direct experience; at ground level. Both perspectives are valuable, but active engagement in the multiple and complex conditions of the everyday user is critical to the actively engaged designer who wishes to move beyond "rational problem solving (Anderson, p. 17)". Critical pedagogy recognizes the ambiguity of ownership and production of space and that inhabitants occupy and shape their daily lives within and in spite of institutions of architectural and social infrastructure. Architects' recognition of the power of individuals to negotiate and claim space and the ways that they do is vital to successful intervention. Buildings are not passive occupants of space. Instead, meaning is developed through relationships with people, space, and social systems. Architects need to understand these relationships through active engagement with them.

2.2 Critical pedagogy and public interest design education

Public interest design takes problem solving education further by empowering students to participate in community-formation and to recognize how the effects of their knowledge production gives shape to the world's complex problems. It embraces an engaged methodology that elevates issues of social justice in the design process and the lived experience of the future inhabitants of the spaces architects design.

Engaging complex contemporary issues through architectural work thus requires a theoretical framework to critically orient architects' activities toward change-creating action. Public Interest Design not only produces spaces that are inclusive and place based but also creates a theoretical framework that incorporates values of equity, inclusivity, and social justice through action or process. (Anderson, 2018, p.16)

Participatory design emerged in the U.S. in the 1960s, with a goal of making design methods more transparent and inclusive of users' needs (Hofmann, 2015). Public interest design evolved from this effort, inspired by social justice movements about engagement through collaboration. The practice recognizes that positive change to systems of injustice often begins with grassroots claims by the oppressed. Architectural designers recognized that the successes of the Civil Rights and disability rights movements were in part, due to the ability to draw together the related interests of separate groups with different missions, methods, and audiences to organize for equal rights for the oppressed (Brown Wilson, 2016). This idea was codified in the disability rights slogan "Nothing about us, without us, is for us" which made it clear to all involved that disabled Americans were naming problems, defining solutions, and demanding the changes that they needed; not what others felt were best for them (Brown Wilson, 2016). The changes disabled rights organizers demanded to public infrastructure and buildings were once seemingly intractable, but their collaborative, grassroots approach eventually resulted in the Americans with Disabilities Act, which has transformed the American public landscape to become more accessible for all.

Coupling the teaching philosophy of critical pedagogy with public interest design in architectural education moves architecture students beyond simply working on behalf of a community client to address design issues relevant to them. This model extends and deepens the work to engage all involved in a critique of the underlying, systemic root causes of harm faced by the community and of how design practice reifies unjust methods with a goal of changing design practice and outcomes to transform the lives of the oppressed. In a critical pedagogy-informed public interest design studio, architecture students engage directly in research and dialogue about injustice and ask how they have, how the discipline has, and how other institutional systems have or have not contributed. After this critical learning, in this model students, teachers, and community members are called upon to be actively anti-racist, sexist, classist, and ableist through their actions. All participants are invited to use their skills through a dialogic, collaborative process, and are empowered to embrace responsibility for the outcomes through a cycle of dialogue, action, and reflection. Educators and their students are asked to strip their expert mindset and to value the lived experience of the community members. The praxis reframes the assumption of architect-as-expert in favor of an approach that recognizes the power and worth of local knowledge.

3.0 A CLOSER LOOK

A summary of a critical pedagogy-informed public interest design studio taught for five years at the University of Massachusetts Amherst will provide a closer look at how critical pedagogy is utilized to shape both curriculum content and practice. In this studio course, students partner with a community group (often a nonprofit organization providing services for underserved members of the community) to engage in partnership-building and in a co-design process that values the everyday lived experiences of the inhabitants as much as the technical expertise of the design students. In

the course, undergraduate seniors explore critical, participatory, and process-focused strategies for community-based design practices and think critically about their theoretical and historical foundations. They consider how contemporary social and institutional systems intersect with and shape the experiences of our design partners and how design practices have contributed to shaping outcomes.

The course is broken down into four intersecting phases, established to move the students from passive to active engagement. The first phase provides an opportunity for students to understand the origins and implications of public interest design praxis. The second phase engages students in analysis of the social/political context for their partnership and recognition of their participation in the systems of oppression that impact the work. The third phase involves relationship-building with the community partner, and the fourth is the co-design phase where students and community partner generate design ideas together. While not a distinct phase on its own, reflection is also critical part of the course. Students are asked to pause at multiple points during the semester to think critically about what they have learned and how they are participating in the process. Students are evaluated by their classmates and instructor, and they self-evaluate the quality of their in-class participation, submitted assignments, and participation in collaborative work.

Phase one of the course is seminar-like, with a focus on readings and research related to the history of public interest design, community engagement methods, architecture's intersection with institutional systems of oppression, and associated case studies. We consider the place of this work in the larger context of architectural education and practice. Following the seminar, in phase two, students begin project-related research which will inform the eventual design project process, but is primarily intended to awaken students to the networked systems of oppression that create the need for design intervention in the first place. Students consider existing architectural infrastructure, but also law and policy, social practices and beliefs in both historical and contemporary contexts to understand why and how the community partner experiences oppression. Phase three is when initial meetings with the community partner take place, in order to begin building a trusting relationship and for all parties to share their unique perspectives. It is here that the praxis of public interest design really begins as students begin to build their allyship and research begins to shape action. Architecture students facilitate design exercises that help community partners share their narratives and needs and develop the generative themes that will inform the work. In the fourth phase, once design needs are identified, and the architecture students are able to share their design expertise with the community to develop solutions and receive feedback. Throughout the process, architecture students are responsible for documenting, organizing, and communicating their research and recommendations for the community in accessible modalities. Each of these partnerships resulted in vastly different design outcomes. What follows are two examples of critical pedagogy's impact on the public interest design studio.

An important principle of critical pedagogy is that students and teachers are asked to value local expertise and to elevate the lived experience of the community members. A co-design partnership with members of Gardening the City, an urban gardening and youth development organization in Springfield, Massachusetts led to an unanticipated outcome when the youth participants were given space to fully articulate their needs and contribute to the design process. Springfield has a majority Black and Latinx population and is among the poorest in the state. Gardening the City aims to tackle the intersecting injustices of food insecurity and youth disempowerment in their education and community by providing urban gardening training and leadership opportunities. Initially invited for the purpose of designing raised garden beds for the group, the architecture students chose to begin the design process with a series of design-focused workshops to grow familiarity with the youth and understand the issues that were important to them. These began with an exercise that asked the youth participants to introduce the architecture students to the organization's day-to-day activities. The architecture students asked questions to encourage the youth to expand their descriptions and through the discursive partnership, were together able to identify a number of obstacles to an effective day in the garden, and ultimately, opportunities to use design to improve those conditions. One of the issues that arose from careful listening to the local knowledge of the youth partners was the lack of a place to sit comfortably during the morning meeting that started each workday. What resulted was the design for a dynamic accordion bench constructed from recycled wood pallets. The movable nature of the bench design was a direct response to the changing number of participants and the material used for the design was again, an outcome of the youth's interest in upcycling materials found on site. The architecture students, anticipating one design outcome, relinquished their own authority as design experts in order to meet the needs of their partners and maintain their engagement in the process. The architecture students were able to elevate the on the ground expertise of the youth and used their architectural training, not to determine the outcome, but to help shape their partner's ideas into reality. The youth continued to be committed to the design process, offering feedback on multiple design ideas, and aiding in the actual construction of the bench.



Figure 1: Architecture students and community organization youth painting co-designed bench. (Author, 2015).

Another of critical pedagogy's foundational ideas is that all participants are invited into a dialogic, collaborative process. During the 2021 spring semester, the studio's partnership was largely undertaken online due to the ongoing COVID-19 pandemic and necessary shift to virtual learning by the university. Students worked with Amherst Survival Center, an organization dedicated to ending food insecurity in the Amherst, Massachusetts region. Initial project-related research engaged the question of why food insecurity persists, who it affects, and its implications for those who experience hunger. Students looked deeply at the individual, infrastructural, and societal levels of policies and practices that both harm and aim to alleviate this systemic issue. Following this discovery phase, multiple online meetings with the organization's leadership, staff, volunteers, and guests humanized the research and informed to a series of proposals for the redesign of the organization's building to expand and make space for rapidly growing needs. The online nature of the course heightened the need for collaboration and engagement since the architecture students were not able to meet in person or experience the space for themselves. Online workshops were designed to elicit conversation about how the spaces were perceived by different users. Workshop participants were asked to select from a variety of images and map them to spaces on a plan-drawing of the building and then discuss how the spaces made them feel. These conversations revealed issues that pushed the students to think beyond the programmatic needs of the spaces. Students considered how design intersects with issues of race and gender identity, feelings of pride and shame when asking for help, comfort and safety, accessibility for the elderly and those with disability, and other issues that were not familiar to them by virtue of their personal experience. Through the collaborative process, students were able to empathize and understand how architecture shapes basic human needs and how those needs are different for those who experience the oppressions of racism, ageism, and ableism. While the actual design and construction of a new building is a long way off, the students were able to work in inclusive teams to provide design ideas for the partners to consider. Students and partners alike brought a wide range of perspectives and experiences to the table which made the resulting designs more effective and meaningful.



Figure 2: Sample image of online workshop activity. (Author, 2020).

4.0 DISCUSSION

In both of the cases described above, dialogic process and focus on the lived experience of the partners to inform the design process resulted in thoughtful engagement and impactful design outcomes for the community partners. As the director of one partner organization wrote, the process itself has positive effects on the community partners who participate too. When they recognize that architecture is a catalyst for addressing the issues that they face every day, they become engaged members of the built environment. "The world is a scary place for these adolescent minds and it can be challenging to navigate without a light on the possibilities that exist. The experience our members had has shined a light on a world of possibilities." (T. Crossman, 2019)

Architecture students are also impacted by the process. While the course is highly collaborative, a practice of written individual reflection is woven into the semester at various points to offer students the opportunity to think critically about their own education experience and challenges they encounter in the participatory process. Through these reflections students demonstrate that they are critiquing the hidden curriculum of the design studio and connecting their work to larger systems of injustice in the world. One student spoke to the challenges to her expert mindset, “Sometimes going into a meeting I think I know what a space is like, but after speaking with our partners I find out I am wrong because they experience details and movement that I would not expect just from looking at the drawings” (S. Shepherd, 2021). Another student connected his personal experience as a Latino to the work of the studio:

I grew up balancing two different cultures, two different languages, and two different cultural expectations. On top of this balancing act, I have had to battle against the stigmas attached to the word “immigrant,” which meant that people often expected the least of me or counted me out entirely. These challenges have made me who I am today: a hard worker determined to fight against the stereotypes and stigmas associated with being both a young, Latino man and an immigrant. As a community, it is important to understand that inclusivity has to be a part of everything we do, for the world is only becoming more diverse and heterogeneity prompts progress and innovation. This is why it is crucial to begin the design process with people of all different fields in the community. (A. Ortiz, 2021)

While the course described here actively disrupts the traditional studio hierarchies and makes space for diverse voices to engage in understanding and dismantling underlying problems that oppress members of society, challenges do exist to expanding the reach of this pedagogy. It is a leap to expect all architecture programs to embrace this participatory practice throughout the curriculum. Partnership building takes time and there are often unpredictable outcomes that frustrate students who anticipate having a meaningful engagement. It is also difficult to teach foundational architectural design and representation skills while also teaching to transgress systemic oppression. Faculty who are called upon to develop expertise in their field can be troubled by collaborative practice that challenges their hierarchical position in the classroom.

However, there are opportunities to incorporate critical pedagogy into every level of the student educational experience. Social responsibility is a crucial concern and there are ways to transform the traditional studio practice to engage some, if not all of the principles of critical pedagogy. Faculty should be critical of their own bias towards the methods they were trained in and recognize the ways that the studio is not inclusive. Architecture design studios can elevate student voices and encourage more collaboration among students to encourage self and peer-critique. Faculty can introduce a broader set of precedents, including indigenous and contemporary examples from global geographies and cultures. And while many studio design projects must remain hypothetical, they should be designed to address the complex and underlying institutional systems that shape our lives. Students can be invited to have meaningful dialogue with one another and to reflect on their personal lived experience in the context of assignments.

Additional challenges exist in the translation of this approach from academia to practice. Some students may resist engagement in work that is explicitly for the common good because the capitalist system works against the goals of critical pedagogy. Earning a college degree leaves students with mountains of student loan debt to pay so graduates may be driven by income over ideology in their job selection. In addition, the architecture profession relies largely on a fee for service model that prioritizes the paying client, not necessarily those living in underserved communities. Post-graduation, emerging architects may not have the agency to choose the methods of practice or clients they engage with, but they will carry their critical pedagogy knowledge into their early design firm experiences. It is the hope that the more students who are educated and aware, the more will communicate and act.

CONCLUSION

Architecture design education is changing to confront systemic injustice through increased representation by students and faculty of color, and through changes to curriculum. Educators everywhere are actively struggling to transform what they teach, but there remains an opportunity to confront historically biased teaching methods and to challenge the hidden curriculum of the studio. As educators look for ways to be more intentional about dismantling systemic oppression, critical pedagogy provides a framework for changes to practice in the design studio and other courses.

Critical pedagogy-informed public interest design education is not utopian or objective. Liberation and oppression coexist in this applied theory. It is important to recognize that architecture students, and the professionals they will become, are active participants in society and can affect change through their beliefs and practices. The praxis invites students to develop and balance the creative demands of the craft with the technical rigors of their designs and a deep consciousness of community. It recognizes that sites of design are complex networks of interacting forces that need to be identified, understood, and engaged (Horner et al, 2016). The studio, shaped by critical pedagogy, disrupts the expert mindset that students adopt when they are disengaged from the political, historical, and cultural realities of the inhabitants and their sites and it fully engages students in a collaborative design process that elevates multiple modes of student and community strengths and experiences. Ultimately, this disruption of the traditional education will transform the profession by introducing critical thinkers to the discipline and by enabling communities to have a meaningful voice in shaping their built environment.

REFERENCES

- Aliakbari, M. & Faraji, E. (2011). Basic Principles of Critical Pedagogy. *2nd International Conference on Humanities, Historical and Social Sciences*. IPEDR vol.17, pp. 77-85. Singapore: IACSIT Press.
- Anderson, N. (2014). Public Interest Design as Praxis. *Journal of Architectural Education*. 68:1, pp. 16-27. DOI: 10.1080/10464883.2014.864896
- Bachman, L. & Bachman, C. (2009). Affecting Change in Architectural Education. *Enquiry The ARCC Journal for Architectural Research*. Vol. 6, no. 1, pp 4 - 5. DOI:10.17831/enq:arcc.v6i1.2
- Brookfield, S. D. (2005). *The power of critical theory for adult learning and teaching*. Open University Press.
- Brown Wilson, B. (2016). What social justice movements can teach us about public interest design. In L. M. Abendroth & B. Bell (Eds.). *Public Interest Design Practice Guidebook*. pp. 19 – 33. New York: Routledge.
- Clausen, Meredith L. (2010, June). The Ecole des Beaux-Arts: Toward a Gendered History. *Journal of the Society of Architectural Historians*, Vol. 69, No. 2, pp. 153-161. Retrieved from: <https://www.jstor.org/stable/10.1525/jsah.2010.69.2.153> <https://doi.org/10.1525/jsah.2010.69.2.153>
- Cret, Paul, (1941, April). The Ecole des Beaux-Arts and Architectural Education. *Journal of the American Society of Architectural Historians*. Vol. 1. No. 2, pp 3 – 15. <https://doi.org/10.2307/901128> .
- Crossman, T. (2020). Unpublished correspondence. [CITY], Massachusetts.
- Crysler, C. G., (1995, May) Critical Pedagogy and Architectural Education. *Journal of Architectural Education*. Vol. 48, No. 4, pp. 208-217. Retrieved from: <https://www.jstor.org/stable/1425383>
- Dutton, T. (1987). Design and Studio Pedagogy. *Journal of Architectural Education*. 48:1, pp. 16-25. Retrieved from: <https://www.jstor.org/stable/1424904>
- Freire, P. (2000). *Pedagogy of the Oppressed*. 50th Anniversary Ed. New York: Bloomsbury Academic.
- Hofmann, S. (2015). Participation and Architecture. In *Architecture Is Participation: Die Baupiloten: Methods and Projects*. (pp. 8-41). Jovis.
- Horner, B., Young-Jahangeer, M. & Dhunpath, R. (2016). Performing Problems on the Pavement: An Innovative Approach to Architectural Education in Post-Apartheid South Africa, *Journal of Architectural Education*. 70:2, pp. 203-213. DOI: 10.1080/10464883.2016.1197667
- Nicholson, K. (2014, December). NCES Data on U.S. Programs in Architecture and Related Fields. Association of Collegiate Schools of Architecture. Retrieved from: <https://www.acsa-arch.org/resources/data-resources/nces-data-on-u-s-programs-in-architecture-and-related-fields/ethnicity-and-gender-of-graduates/>
- Ortiz, A. (2021, June). Reflection paper. Unpublished, [UNIVERSITY]. [CITY], Massachusetts.
- Pozdnyakova, L. (2020). The Value of the Finished Project: Architectural Education from the École des Beaux-Arts, the Bauhaus, and Black Mountain College. *Plat Journal*. Rice Architecture. Retrieved from: <https://www.platjournal.com/eightpointfive/the-value-of-the-finished-project-architectural-education-from-the-ecole-des-beaux-arts-the-bauhaus-and-black-mountain-college>
- Rothstein, R. (2018). *The color of law*. Liveright Publishing Corporation.
- Sitz, M. (2020, July 13). NCARB By the Numbers 2020 Offers Closer Look at Demographics and Diversity. *Architectural Record*. Retrieved from: <https://www.architecturalrecord.com/articles/14716-ncarb-by-the-numbers-2020-offers-closer-look-at-demographics-and-diversity>
- Shepherd, S. (2021, June). Reflection paper. Unpublished, [UNIVERSITY]. [CITY], Massachusetts.
- Simon, M. (2002, June). Professional Education in the Beaux-Arts Atelier. 2002 ACSA International Conference. pp. 194 – 200.
- Sutton, S. E. (2017). *When Ivory Towers Were Black: A Story about Race in America's Cities and Universities*. New York. Fordham University Press.
- Young, W. (1968, June). Full Remarks of Whitney M. Young Jr. AIA Annual Convention. American Institute of Architects. Retrieved from: <https://www.aia.org/resources/189666-commemorating-50-years>

Geohome: Affordable, Resilient Housing Prototype

George Elvin¹

¹North Carolina State University, Raleigh, NC

ABSTRACT: Living well in the 21st Century requires resilient architecture. With climate-related disasters increasing daily, architecture must respond by enabling rapid and sustainable adaptability to unforeseeable events. However, current architectural responses can often be merely *adapted* to specific climate hazards rather than *adaptive* to those still to come. Non-adaptive structures are unsustainable and are often priced beyond the means of underserved communities. Can 21st Century architecture be resilient, sustainable, and affordable? Light Timber Construction is proposed as an affirmative answer. This article describes the background, value, methods, and results of the ongoing research project behind this innovative alternative to conventional construction methods. The light-wood framing used in conventional construction may be unsuited for resilient construction, as evidenced by the \$24 billion in property damage in North Carolina alone during Hurricane Florence. In disasters like these, the most vulnerable communities often suffer the most, and the Light Timber Construction project aims to create greater equity in resilient housing. This paper describes the innovative, nature-based design strategies and construction methods behind Light Timber Construction as well as its potential benefits in equity, affordability, resilience, and sustainability. Research methods to be discussed include 1) the extensive study of resilient plants and animals in extreme environments, 2) recent full-scale prototype construction experiments, and 3) plans for computer simulation and testing using finite element analysis (FEA). The results of completed research on nature's lessons in resilience will be discussed here, as will the results of recent full-scale prototype construction experiments. The results of upcoming FEA testing will be addressed in forthcoming publications. With nature as our teacher, we are confident that we can adapt our dwellings to our climate crisis so that people of all means can live safely and sustainably in the years ahead.

KEYWORDS: hazard mitigation, disaster resilience, risk reduction

1. INTRODUCTION

Light Timber Construction (LTC) is proposed as a novel approach to construction hybridizing light wood framing and mass timber construction. It aims to create affordable, resilient, and sustainable structures. Its resilient design applies lessons learned from plants and animals living in some of nature's most extreme environments to architecture. Sustainability in building operation is sought through a design not only adapted to current environmental challenges but also adaptive to the uncertainty of future hazards. Sustainability in the production of materials is sought through the efficient use of renewable, carbon-sequestering wood products. Affordability can be achieved by reducing the number of structural members and by the improved durability of LTC's resilient structure. While LTC may prove applicable to multistory construction, this paper focuses on its application to single-family home construction. A prototype single-family home, nicknamed the Geohome, has been designed, and a section built employing light wood framing. Results from this construction experiment led to the creation of the LTC's light timber "lattice framing" system. These experiments also led to design improvements that will be tested by computer-simulated finite element analysis of a structural model in 2022. Results will enable a comparison of LTC to conventional light wood framing with respect to hurricane-force wind resistance. A cost comparison will also be conducted.

Light Timber Construction aims to improve on the resilience of light wood framing in architecture. In 2018, Hurricane Florence caused \$24 billion in property damage in North Carolina. This catastrophic damage was not only the result of a powerful hurricane; it also resulted from building stock not designed to withstand such force. Because many of North Carolina's most vulnerable citizens occupy low-quality housing in areas prone to hurricanes and flooding, they were particularly hard-hit by this disaster (Mohai et al. 2009). What are the prospects for vulnerable communities in a future where larger and more frequent hurricanes are the norm? Building codes will continue to strengthen our housing stock, but they are unlikely to keep pace with future hurricanes and other climate disasters. The \$24 billion in property damage done by Hurricane Florence in North Carolina is a clear indication that change is needed to the design of housing. The Light Timber Construction project works backward from the ideal of zero damage to create safe, affordable housing for all by asking, "What would hurricane-proof housing look like?"

To answer this question, the author looked to nature. Studying plants and animals in extreme environments has yielded valuable lessons in resilient design. While natural features, plants, and animals suffer damage in climate disasters, the resilience of nature—especially when compared to the \$24 billion in damage to non-resilient property from one storm in one state—is remarkable. Light Timber Construction takes lessons learned from onsite analysis of North Carolina coastal ecosystems and applies them to the design and construction of hurricane-resistant housing. The North Carolina

coastal live oak, for example, entwines its roots and branches with others to create a stormproof shield where wildlife takes refuge from hurricanes. This and many other lessons from nature add up to a novel approach to hazard mitigation, one that works with nature rather than against it, much as skilled martial arts practitioners use their opponents' strength against them. Because the project is ongoing, this paper focuses on the design approach, initial findings, and evolving plans for the work. The final results of the work will be discussed in forthcoming publications. Here, the author describes the project work to date in order to present the concept and motivate additional hurricane resilient design work across the broader community.

2. GOALS AND OBJECTIVES

2.1 Light Timber Construction Research Program Goals

The Geohome prototype structure is part of the Light Timber Construction research program. LTC program goals include resilience, sustainability, and affordability. LTC performance relative to these goals will be measured against that of conventional light wood construction.

Resilience

Resilience in the face of increasing climate and natural hazards is an essential feature of 21st Century architecture. Buildings must be not only adapted to current climate and natural hazards but adaptive to unpredictable hazards yet to come. Specifically, Light Timber Construction seeks to take advantage of the flexibility of wood structural members and their connections in a "bend but don't break" response to hazards. The result sought is an elastic structure whose movement transforms some of the energy from climate and natural hazards such as wind, flooding, and earthquakes and disperses it in acceptable deflection of the structural system and transfers that energy to the ground.

The connections between structural members are of particular concern with respect to resilience. Light wood frame buildings consist of many small members such as wood studs and their numerous connections. These connections have been found to be the primary source of structural failure in post-hurricane forensic studies (Pistrika and Jonkman 2010). However, alternatives to wood framing such as concrete and steel are not cost-effective alternatives for most coastal buildings. LTC significantly reduces the number of connections in the structure relative to conventional light wood framing. Resilience is also fostered by the structure's fiber-reinforced cement panel cladding, one of the strongest cladding materials available. The large panels also reduce the number of cracks in the building exterior, thereby reducing opportunities for wind and moisture penetration. Fenestration is also designed to minimize opportunities for wind and moisture penetration. Most of these resilient design strategies were developed from the first-hand study of plant and animal behavior in extreme environments.

Sustainability

A green building destroyed by climate or natural hazards is not sustainable; resilience makes buildings more sustainable. Light Timber Construction uses renewable, carbon-sequestering wood products to create resilient housing. Its innovative lattice framing system is designed to use less wood than conventional construction but be stronger and safer in hurricanes. Its fiber-reinforced cement panel cladding also offers environmental benefits, including improved durability, recyclability, and organic composition (Zabcik 2018). LTC's benefits for sustainable, carbon emission-reducing forestry in the North Carolina timber industry will also be explored.

Affordability

Another goal of the LTC project is to make disaster-resistant housing LTC cost-competitive with market housing. This goal can be achieved by reducing the number of structural members and fasteners as compared to light wood framing. In addition, fiber-reinforced cement panel cladding requires less maintenance than many other cladding systems. The resilience of the LTC structure also contributes to its affordability since durability and longevity reduce maintenance and replacement costs. Affordability is also a cornerstone of social equity grounded in the principles of social justice and environmental justice (see below).

2.2 Geohome Prototype Project Objectives

- Develop a collection of nature-based design lessons for resilient, hurricane-resistant housing design (completed).
- Complete construction experiments in the full-scale construction of a portion of a prototype structure (completed).
- Create a three-dimensional computer model of the Geohome, an LTC prototype structure.
- Conduct a finite element analysis of computer-simulated structural prototype dwelling.
- Synthesize test results and define design improvements for publications and proceedings.
- Apply test results to large-scale funding applications to the National Science Foundation, Federal Emergency Management Agency, Department of Energy, Environmental Protection Agency, Department of Homeland Security, and others for whole-building testing.

3. THEORETICAL FRAMEWORK

The Light Timber Construction project combines nature-based lessons in resilient design with the theoretical underpinnings of systems theory, human ecology, and environmental justice. Systems theory outlines a comprehensive

method and cognitive framework for understanding complex systems (Bertalanffy 1969). It emphasizes the role of processes and relationships in understanding, analyzing, and modeling dynamic systems and synthesizing complex systems' environmental, social and economic factors. It adopts an integrated human ecology approach to design to synthesize relevant human behavior, hazard analysis, and environmental design. Odum and Barrett (1984) have applied systems theory to the study of ecology, and their work heavily influences contemporary environmental studies. Human ecology targets the interrelationships between humans and their environment (Steiner 2002). However, a comprehensive systems approach has not been consistently applied to hazard mitigation research. The LTC project is grounded in systems theory and human ecology to help ensure a comprehensive analysis of the social, environmental, and economic conditions at work in the coastal built environment.

Environmental justice--the principle that "all people and communities are entitled to equal protection of environmental and public health laws and regulations"--is a critical concern in the development of the LTC system as well (Bullard 1990). Socially vulnerable households often live in low-quality light wood frame housing that can sustain considerable damage during disasters. They also inhabit areas more prone to disasters. Environmental justice performance criteria are woven into the goals of the LTC project and cross-referenced with other architectural and environmental performance criteria to help ensure that the project addresses the 17 Principles of Environmental Justice outlined by the First National People of Color Environmental Leadership Summit (Delegates 1991).

4. CONSTRUCTION

In Light Timber Construction, "light timber" refers to wood products with sectional areas of more than ten square inches and less than forty square inches. This range of wood products includes "4x4" and "6x6" structural members measuring 90mm by 90mm and 140mm by 140mm (3.5 inches by 3.5 inches and 5.5 inches by 5.5 inches), respectively. Whereas light wood framing relies on smaller framing members (wall studs measuring 5.25 square inches, for example,) running in parallel to frame walls, floors, and roofs, LTC uses a lattice structure and X-bracing (Figure 1). By using fewer, stronger structural members, the LTC system reduces the number of fasteners in the structure. This may increase the strength of the structures, as forensic studies after hurricanes have found that structural failure in hurricane-impacted residential construction is due more to the failure of fasteners than to the failure of structural members (Pistrika and Jonkman 2010). The lattice framing of the LTC system also greatly reduces the number of 90° right-angle connections that can place more stress on structural members and their connections. Instead, it relies on X-bracing with more 135° connections that can transfer loads more smoothly to the ground.

In the Geohome experimental structure, fiber-reinforced cement panels (FRCPs) are set into grooves in the structural members forming the walls. Fiber-reinforced cement panels have proven effective in resisting hurricane-force winds and are durable and sustainable relative to many other cladding products (Energias 2019). Setting FRCPs in grooves in the structural timbers also reduces the reliance on mechanical fasteners that can fail in high winds and flooding. The Geohome experimental structure also includes a standing-seam metal roof, another construction system shown to outperform other roofing systems in high winds and heavy rains (Zabcik 2018).

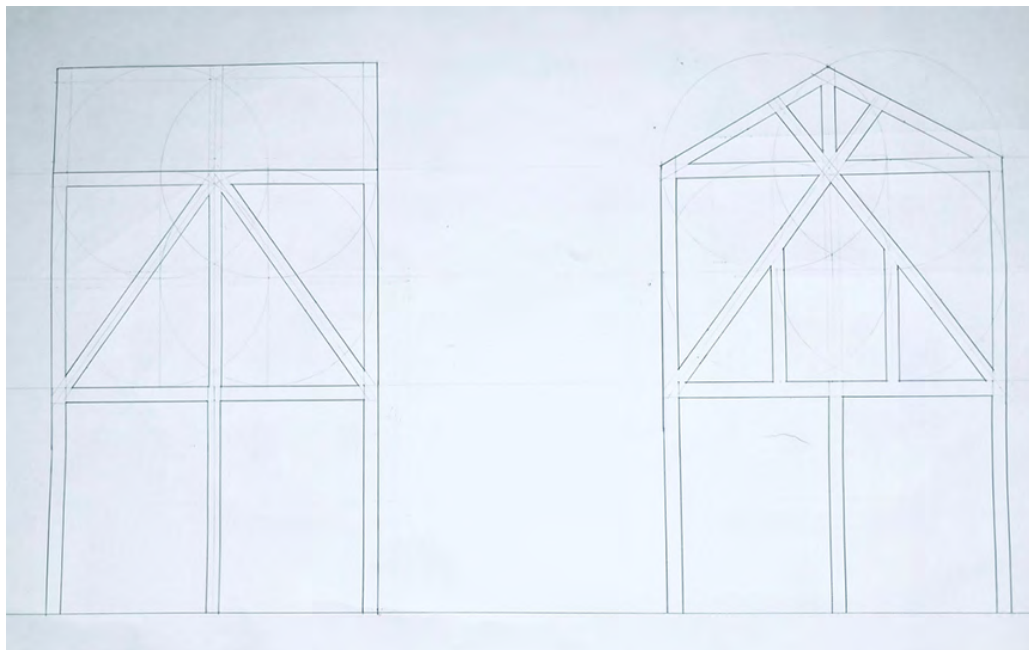

Figure 1: Light Timber Construction uses structural members measuring 3.5 inches by 3.5 inches and 5.5 inches by 5.5 inches in an X-bracing pattern to transfer wind loads to the ground.

5. RESEARCH METHODS

Research methods include 1) the extensive study of resilient plants and animals in coastal Carolina ecosystems, 2) recent full-scale prototype construction experiments, and 3) plans for finite element analysis of a computer-simulated prototype structure. Extensive research was conducted onsite on the Outer Banks and Inner Banks of North Carolina to learn how plants and animals adapt to extreme environments. These nature-based lessons were then applied to the design of an innovative light wood framing system for safer coastal housing. Once a satisfactory design was developed, construction of a prototype structure began at a Raleigh facility. A structural frame was nearly completed when the facility was closed as a precaution due to COVID. Construction did, however, lead to improvements to the frame design, specifically, the replacement of light wood framing with Light Timber Construction.

The project to date has already yielded significant research outcomes. Onsite research on the Outer Banks and Inner Banks has led to an extensive body of data on resilience in nature, which has been applied to the new design and publications and talks by the PI as well as new teaching materials and methods. Lessons learned from field study and prototype construction have also contributed significantly to teaching, as over seventy graduate and undergraduate students have been impacted by improvements to design studio and seminar courses on nature-based resilient design of structures.

5.1 Learning from Nature

The Geohome is a prototype LTC structure, a hurricane-resistant dwelling whose unique design draws from nature. Its wood frame emulates the structure of the coastal live oak; its water-, wind- and fire-resistant cement shell evolved from the study of coastal seagrass; its protective window and door coverings embody the protective features of coastal bobcats, and it perches high on protective stilts like a great blue heron to avoid flood damage. It combines these nature-inspired resilient design features to improve residential building performance in hurricane conditions. A typical strand of coastal Carolina Sea Grass, for example, can be hundreds of times taller than it is wide, and yet it thrives in the face of hurricanes and other extremes. Its form was the inspiration for the compact sectional shape of the Geohome prototype. The interwoven roots and branches of the coastal live oak also inspired the lattice framing of the structure. These and other nature-based resilient design strategies may help the Geohome adapt to nature's forces rather than resist them.

Nature's Principles of Resilient Design

Resilience

Ability to adapt to change. Adaptability.

Regeneration

Renewal, restoration, or replacement of components, relationships, and processes necessary to system health.

Efficiency

Minimal expenditure of energy for maximum achievement of or striving for goals.

Diversity

Wide variety of unique components, relationships, and processes. Diversity of means to achieve goals.

Interdependence

Reliance of components, relationships, and processes on each other for achievement of goals.

Nature-based design and biomimicry are often considered models for resilient design capable of standing up to climate disasters. However, these approaches are seldom based on the direct study of ecosystems. The author has spent over ten years studying extreme environments first-hand, including the world's hottest, wettest, windiest, and snowiest places, and has developed an extensive and detailed collection of design lessons by studying how plants and animals adapt to extreme events and environments. The Light Timber Construction research program then applies nature's lessons to the design of buildings.

Table 1: Resilient plant and animal attributes and their architectural applications.

Plant/Animal	Attribute	Architectural Application	Attribute
Coastal Live Oak	Entwines roots with other live oaks for increased wind and erosion resistance	Root-like foundation	Spreads out to resist hurricane-induced uplift
Seagrass	Hollow, tubular form with remarkable strength to weight and length ratio	Fiber-reinforced cement cladding	Strength
Bobcat	Third eyelid protects eye from dust storms	Pocket storm doors and windows	Protect glazing
Great Blue Heron	Long legs carry body over water	Raised pier foundations	Lift home above floodwaters
Tusk Shell	Tubular structure can withstand water pressure at 2,000 meters	Fiber-reinforced cement board cladding	Withstand hurricane-induced impacts

5.2 Construction Experiments

During the summer of 2020, a full-scale octagonal section of the Geohome prototype dwelling was constructed at a facility in Raleigh, North Carolina (Figure 2). This was the first experiment with lattice framing, but it employed light wood framing members (2x4s) rather than light timber members. The use of light wood framing members required numerous, complex connections and the compound cutting of up to eight structural members for a single connection. In August 2020, the facility was closed as a precaution against COVID, but not before certain conclusions were reached about the design. In order to reduce the number and complexity of connections, it was decided to move forward with a more conventional rectangular section for the dwelling and to employ larger structural members.



Figure 2: Full-scale construction experiments in light wood framing led to the development of Light Timber Construction.

5.3 Finite Element Analysis

Moving forward, the Geohome will be modeled as a three-dimensional computer simulation. Computer simulation of the structure enables the application of scalable numerical methods to calculate mathematical expressions that can, in turn, help the research team predict the behavior of the structure under static and dynamic loading conditions. The dynamic loading conditions produced by hurricane winds can be simulated and applied to the Geohome computer simulation using finite element analysis (FEA) computer software. Finite element analysis uses mathematics to understand and quantify structural behavior (Szabó and Babuška 1991). Using FEA sidesteps the challenges of building a full-scale prototype, outfitting it with sensors, placing it in a hurricane-vulnerable location, waiting for a hurricane to strike, and hoping that the hurricane does not destroy the testing equipment. In this project, FEA will be used to predict how a computer model of the Geohome prototype behaves under computer-simulated wind loads. Data collected in FEA testing will then be compared to standard building framing performance as documented by others to determine if the LTC structure can enhance hazard mitigation without increasing construction costs.

Project Timeline

2019-present	Design prototype
2020	Construct prototype structural frame
2021	Refine design based on construction experiments
2022	Create 3D computer model of Geohome Conduct finite element analysis of Geohome Analyze data and synthesize results Document results
2023	Disseminate results

6. PROJECT OUTCOMES AND FUTURE DIRECTIONS

Deliverables resulting from the project will include 1) a compendium of nature's lessons in resilient design (completed), 2) a partial full-scale prototype for hurricane-resistant housing (completed), 3) a 3D computational model of the full Geohome, and 4) test results from finite element analysis. Published results contributing to the body of knowledge on hazard mitigation and resilient design will also be produced. Testing will advance mitigation-related practice by determining the Light Timber Construction system's viability for further development and deployment in socially vulnerable communities most affected by disasters. Data collected from finite element analysis will also help the research team refine the design, possibly leading to the testing of a full-size, residential-scale building against the forces of wind, fire, and earthquakes. Such resilient structures could then play a role in improving building codes for a safer built environment and significantly reduced property damage. With nature as our teacher, we are confident that we can adapt our dwellings to our climate so that people of all means can live safely and securely in North Carolina and beyond.

ACKNOWLEDGMENTS

The author would like to thank the Natural Hazards Center and North Carolina State University for partial funding of the project.

Approaches to Affordable Housing Design Using VAE and Space Syntax: Case Studies from Los Angeles

Junyoung Myung¹, Taegy Lee², Jungyun Choi²

¹University of Illinois at Urbana-Champaign, Champaign, IL
²Seoul National University, Seoul, SOUTH KOREA

ABSTRACT: The purpose of this study is to explore the opportunities and challenges in the use of the Visual Access and Exposure (VAE) and the Space Syntax approach in design for the future of affordable housing development in Los Angeles. Historically, affordable housing developments have been related to a lack of attention to society's housing needs in architectural design. Architectural design is a crucial element to achieving good quality affordable housing, yet this element has played a minor role in deliberations concerning various aspects of the lives of low-income residents such as their social and cultural values. In this respect, the Space-Syntax-based approach to understanding the relationship between socio-spatial practices and residential environments has been strongly connected to the efficacy of the result in the urban and architectural design processes (Hanson 1998; Hanson and Hiller, 1998). This study focuses on designing the affordable housing model provided by the Skid Row Housing Trust, currently on the market in Los Angeles, California. This study points out that the socio-spatial practices related to housing use and experiences are not fully considered in the spatial forms of affordable housing. Therefore, this study addresses the need for affordable housing suitable for low-income households and proposes a sufficient housing plan using the Space Syntax methods within the design process. In the design process using the Space Syntax method, spatial configuration and behavior of residents are analyzed through spatial connectivity, integration, and depth.

KEYWORDS: Affordable Housing Design, VAE and Space Syntax in Design Process

INTRODUCTION

Design innovation is needed to shift public perceptions about affordable housing, which has traditionally been associated with public housing for low-income families. Los Angeles, in particular, is experiencing a serious housing issue as a result of a lack of available homes, limited housing supply, land use regulations, and high rent prices. However, architects and various non-profit groups in Los Angeles have recently begun to seriously investigate innovative affordable housing design despite a severe housing shortage and high economic demands. In the development of affordable housing in Los Angeles, non-profit affordable housing development companies, including Community Housing Corporation, are working with architects to develop and preserve affordable rental housing in a variety of ways and changing the lives of families living there. The purpose of this study is to determine whether affordable housing developments applying Space Syntax and VAE improve the quality of housing and highlight innovative affordable housing design as an important solution for the housing crisis. In this study, the analysis of affordable housing in Los Angeles could be a good example of architectural innovation that could better serve the needs of its residents and could reveal the spatial characteristics of public housing or low-income housing through physical and visual analysis. This study also contributes to supporting new possibilities in the architectural design process of affordable housing development using Space Syntax and VAE by evaluating the cases of recently built affordable housing in Los Angeles.

1.0 BACKGROUND

1.1 Affordable Housing in Los Angeles

The City of Los Angeles has produced more residential units since 2010 compared to nearly every other city in California for its population growth. Less than 7,300 units were built in the City of Los Angeles in the last five years, and 6,200 affordable homes were built in The County of Los Angeles during the same period. LA County is also significantly increasing funding through its Affordable Housing Trust Fund, Measure H, and No Place Like Home programs (McKinsey Global Institute, 2019). Despite this housing construction boom and the production of affordable housing increasing every year, the shortage of housing for the low and middle class is still serious. The low level of affordable housing construction is particularly problematic, as Los Angeles has the highest number of chronically homeless people in the nation (13,000), according to the U.S. Department of Housing and Urban Development (2016).

Although more public money is urgently needed, the reality is that Los Angeles must mobilize private capital to meet the scale of this problem. Good and innovative design is an important factor in improving the quality of affordable housing, but it generally plays a minor role compared with cost and value deliberations (Wright, 2014). It's time to turn this local housing crisis into an opportunity to reimagine Los Angeles. At the beginning of the design process, if a new approach to space design based on the analysis of the living patterns of residents is applied, it can be a part of the solution to these problems in a cost-effective, efficient and creative way in designing affordable housing. Interest in a specific design method in the design process can reduce the cost of construction and provide practical benefits to the vulnerable, such as low-income individuals, thus signaling the need for investment in affordable housing.

1.2. VAE and Space Syntax in Design Process

Space Syntax provides a theoretical framework for spatial analysis because it objectively and quantitatively shows the social characteristics inherent in space. By using Space Syntax, it is possible to provide a framework for an objective approach necessary to understand the relationship and composition of each space and to explain the movement of people who connect the spaces and the social exchanges that can occur within the building. Therefore, although the built environment is formed by the social environment, it is not easy to understand the design logic and structure inside it.

The essential problem in understanding a building is to show how to recognize basic building functions and components, how those functional elements create a space structurally, and how to analyze the hidden building system. In this respect, Space Syntax plays an important role in the building design evaluation. Because the spatial topology method is effective in understanding these spatial relationships, it provides an effective tool for architects to show their ideas through buildings and how their designs actually work. In other words, Space Syntax, which approaches topology by quantifying it, can be a powerful means to evaluate building design by finding the formal and functional regularity of buildings in real systems.

In addition, spatial analysis with VAE is based on two variables: visibility and accessibility, which are the most important factors for human behavior in space. Visibility is the variable that determines how far you can see, and accessibility is the variable that determines how easily you can get to each space. Given sensitive issues such as privacy in a home, tools such as Space Syntax and VAE can be prioritized for objective assessment and can be used at an early stage in space organization. For example, in the design process, VAE analysis is used to determine in advance how visual interaction can occur in the space used by actual residents, and adjust the level of privacy protection, plan to install surveillance cameras in crime-prone spaces, separate the flow of movement between residents and visitors, etc. When making such a plan, you can understand the relationship between each space. These case studies of affordable housing show how Space Syntax and VAE can contribute to the design process in a practical way.

2.0 METHODS

In this study, Space Syntax analysis is largely divided into physical spatial analysis and visual analysis. The physical spatial analysis focuses on the connection between one space and another and adjusts the characteristics of spatial configuration. Visual analysis is based on visual perception referred to as the methodologies which focus on human perception and behavior. Techniques usually include Isovist, Visual Access and Exposure model (VAE) model, and Visibility Graph Analysis (VGA) techniques (Benedikt, 1979; Archea, 1985). This study focuses on the VAE model and the integration and connectivity in Space Syntax.

First, the VAE model is based on theory and methods developed by Benedikt and Archea, which quantifies the visual characteristics of space and behavior. This model indicates how the selection of one's location and orientation within an architecturally bounded setting could affect both the information about surrounding activities and the ability of others to observe one's behavior. Benedikt (1979) and Archea (1985) suggest that visual characteristics of a space can be largely divided into Visual Access (VA), which refers to the degree to which information can be obtained from a point through unobstructed visual surveillance, and Visual Exposure (VE), which represents the degree to which an individual can be seen from other arbitrary locations. In other words, it is to grasp the visual interaction that works in space as the ability of 'seeing' and 'being seen.' The VAE value is the sum of all the grids that enter the field of view when space is decomposed into a grid, in which the view is limited to an angle of 30 degrees. The characteristic of vision is very closely related to human behavioral characteristics. Since the more one is exposed in space, the more constrained one behaves, and on the contrary, the more able to grasp a surrounding space, the less restriction to one's behavior. Thus, one is most likely to be proactive without considering the surroundings if the degree of self-exposure in space is small and the degree of seeing is large.

Second, the boundary of the living space is set for the analysis and the entire space is decomposed into spaces for each function, the connection relationship between these spaces is established, and finally, a quantitative analysis index for the connection relationship between each space is calculated. There are two methods for setting the unit space: a convex space and an axial line. The convex space method is a method of expressing a unit space as a kind of closed polygon, and the axis line method is a method of connecting the unit spaces by expressing a route as a single line through a visual analysis method. Based on this method, each unit space can be set as a node, and the connection

relationship between each unit space can be expressed as a graph. In Space Syntax, quantitative analysis is performed based on numerical values and graphs analyzed in the spatial structure expressed in this way.

The degree of integration refers to an index indicating the relative depth and connectivity from one space to another. The higher the degree of integration, the easier it is to access other spaces. In other words, the degree of integration is an index indicating the hierarchical centrality of the spatial structure. Here, depth means 'distance' in graph theory, which is different from the general concept of physical distance. That is, the depth means the minimum number of spaces passed when moving from one space to another unit space. The core of the degree of integration is to find the depth of the shortest path to another node for each node on the graph based on this depth concept. The connection diagram refers to an index indicating the possibility of going from one space to an immediately adjacent space, and the connection diagram for a specific space indicates the number of other unit spaces directly connected to the space.

3.0 CASE STUDIES

3.1. New Carver Apartments

Skid Row Housing Trust's New Carver Apartments were developed to provide permanent housing for older and disabled residents who were previously homeless. On the ground floor, there are many support services for the residents, as well as common facilities such as a kitchen, a common room, and an area where medical professionals and social workers can meet with the residents, as well as a large courtyard. The courtyard is open to all residents and visitors and functions as a space for social interactions. Entering the lobby through the building entrance leads to the center of the building, which then leads to a wide staircase in the central courtyard. The apartment's six-story spiral-shaped building defines a courtyard in its center, providing each unit with natural light and views in all directions. This project contributes to the formation of a community network where residents interact with each other and furthermore, are connected to the neighborhoods around the building.



Figure 1: New Carver Apartments and Courtyard (Photo courtesy of Michael Maltzan Architecture, source: <https://www.mmaltzan.com/projects/new-carver-apartments/>)

3.1.1. Visual Access (VA)

The highest VA value on the first floor is the parking lot because the parking lot is an open and visible space. On the other hand, interior spaces of the building seem to have a low VA value because there are offices, meeting rooms, recycling rooms, the kitchen – all spaces where private activities take place. Thus, VA values are low. The highest access point is also the central courtyard and the public space. The corridor of each floor is visible from the courtyard, which makes this space the most visibly active. Since the study only analyzed the boundaries of the rooftop garden, VA value is seen as low. However, if the analysis boundaries are expanded the rooftop garden should have a high VA value. Thus, the highest VA value of the interior would be the central courtyard, and the highest VA value of the exterior (within building boundaries) would be the rooftop garden. In addition, public spaces (including the community space) and the corridors have also high VA values in the apartment building. The round shape of the corridor makes the spaces open but at the same time, the louver partitions make the space semi-closed.

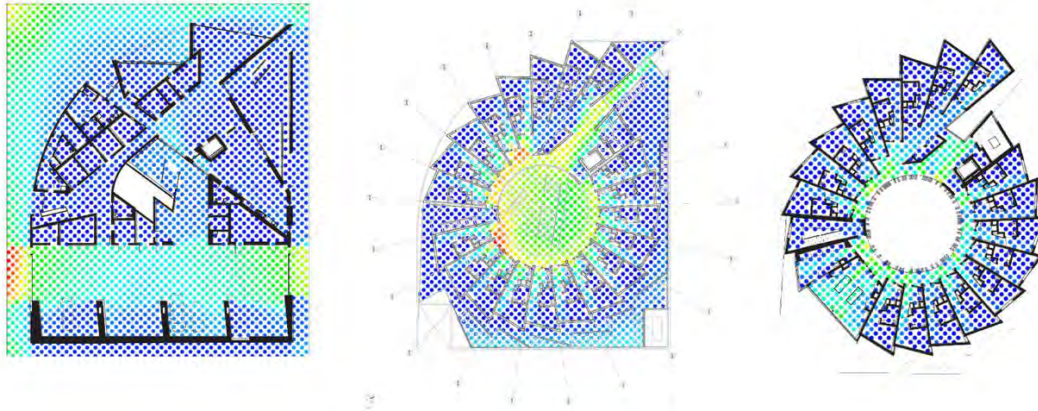

Figure 2: Visual Access of Floor Plan (1st, 2nd, and 3rd Floor)

3.1.2. Visual Exposure (VE)

The most exposed space on the first floor is the parking lot. However, with the exception of the parking lot, the entry and lobby space has the second-highest VE value within the boundaries of the building. This means that this space is easily seen from other spaces. Transitory space such as the entrance, lobby, and corridor seems to have a high VE value. The most exposed space within the second floor is the central courtyard and the public space. This space is composed of a large staircase and a community space. This space is easily seen and is highly visible from its surrounding especially the staircase where most activities of the residents take place. This space works as the most core space that links the first floor to the second floor. The highest VE points are the public space/corridor because the circle-shaped courtyard is open and the corridor is designed according to the shape of the courtyard. However, this space can be seen as a semi-closed space since longitudinal louvers have been installed on the railings (from the ground to top on the void spaces) making the space semi-closed. The purpose of the louvers is to give the residents some privacy when entering their units. Thus, the corridor space is seen to be the most active and exposed space, but, due to the louvers, this space becomes not completely open but semi-open. The community space on the ground level also has a higher VE value than the units. This is because the space is composed of glass walls. The community facility is easily viewed from the corridor where people can see people's activities that are going on within the space.

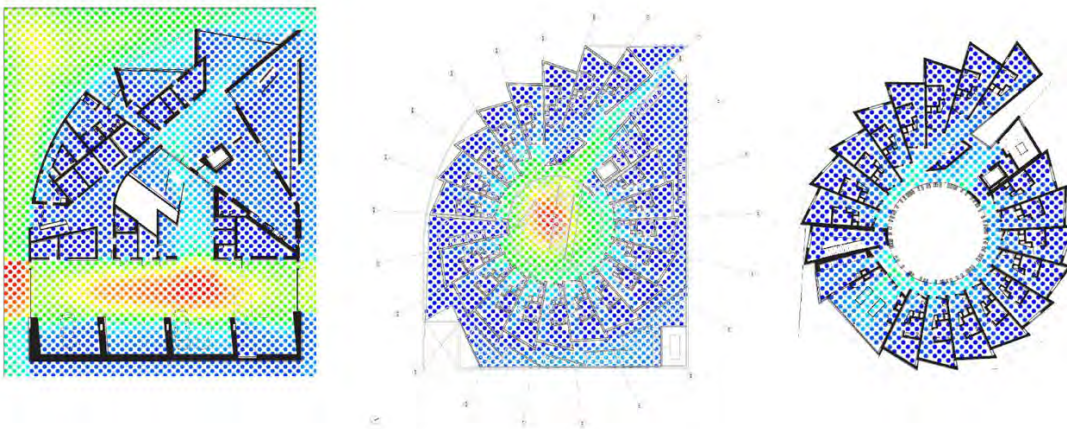

Figure 3: Visual Exposure of Floor Plan (1st, 2nd, and 3rd Floor)

3.1.3. Integration and Connectivity

The most integrated space is the service core (stairs and elevators) and the corridor. The service core that connects the third and fourth floors seems to be the most integrated space along with the corridor at the top of the third and fourth floors. This is because it acts as a connector that links the ground to the third floor and the fourth floor to the rooftop. This space shows the centrality of the entire building. Thus, the ground floor and the rooftop are the least integrated space within the unit. Additionally, as the core on the other floors is composed of spaces moving up and down, the ground floor and the roof floor are composed of core spaces moving one way. The corridor at the center is drawn as four bisecting lines due to the round shape of the building. However, it can be seen as one single space. As the corridor connects all the units this space has the highest integration value. The transitory space that is placed next to the service core has the second most integrated value. This can be interpreted as the second most active space within the floor and building. When the space is to be defined as 'active,' it means that it is easily accessed and most

transitions occur within the space. As the space is active, the space is defined to be open (public space). The corridor and the parking lot are seen as the most connected space within the building. This is because of the characteristic of what a corridor is – a connection space and a transitory space. The parking lot has a high connectivity value due to the number of spaces connected to it such as the store, the corridor, the mechanical room, etc. In addition, the outdoor space on the ground floor and second floor also has a high value. This is because this space connects both internal and external spaces. Overall, the corridor and the service core have the highest integrated value which means they can be defined as the most public space within the building. The dwelling units are the least integrated space which is defined as the least active spaces and private spaces. In addition, most activity occurs on the lower floors (ground and first floor).

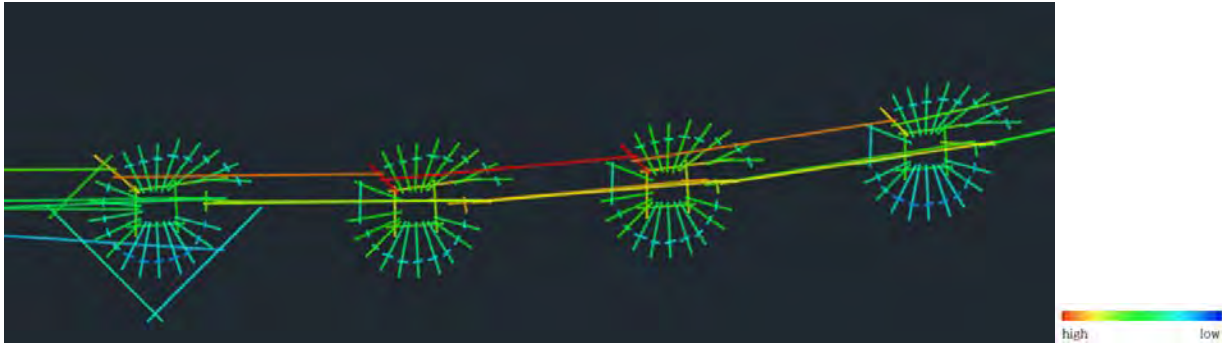

Figure 4: Integration and Connectivity of Each Floor

3.2. The Six

Developing in the Skid Row Housing Trust and designed by local firm Brooks + Scarpa, the five-story apartment complex provides a range of supportive services along with 52 permanent, affordable housing units for formerly homeless veterans. The first floor contains offices, support space for veterans, and bicycle storage and parking. The second floor contains a large public courtyard for apartment residents. The second-floor community room adjacent to the courtyard provides an outdoor gathering space with plenty of light and the rooftop re-illuminates the protected outdoor space. The top floor features a green roof, a large public patio, and a communal garden with panoramic views of the area. All public amenities in this building have been tailored to enhance the building's sense of community. The architects have designed the courtyard, a public space, to encourage residents to meet each other and engage in various activities together in one space rather than being confined to their own spaces. In addition, the architect tried to connect the two-story courtyard surrounded by four-story dwelling units spatially and visually with the inner space of the building as well as the surrounding streets. This allows residents to interact with other residents and visitors in the community space and enjoy more open space.



Figure 5: The Six and Courtyard (Photo courtesy of Brooks+Scarpa, source: <https://brooksscarpa.com/the-six>)

3.2.1. Visual Access (VA)

The space located inside the first floor has a very low VA, so it seems difficult to observe the user's behavior. In general, these spaces exhibit the characteristics of spaces that have no choice but to passively accommodate residents or visitors. Since this space is being used as a conference room, it can be said that it is placed in an appropriate location visually and functionally. Since the VA is high in the south parking entrance and the west exterior space on the first floor, people can identify the parking space at a glance when they enter the building. It can be seen

that the VA on the second floor appears high in the space in front of the north stairway and in the south hallway. This means that the residents interact a lot with the courtyard and are also visually open to the exterior of the building. The VA value of the 3rd to 5th floors with dwelling units was highest in the corridor leading to each household. This means that the area that can be seen from the hallway is the widest, except for private spaces where both VA and VE values are low. On the other hand, unlike the stairwells and elevator cores in the south, the stairwells in the north have low visual interaction. Both VA and VE are low, so it can be said that the probability of crime in this space is the highest. The rooftop garden, like the courtyard on the second floor, generally shows a high VA, suggesting that it is a space suitable for residents to interact.

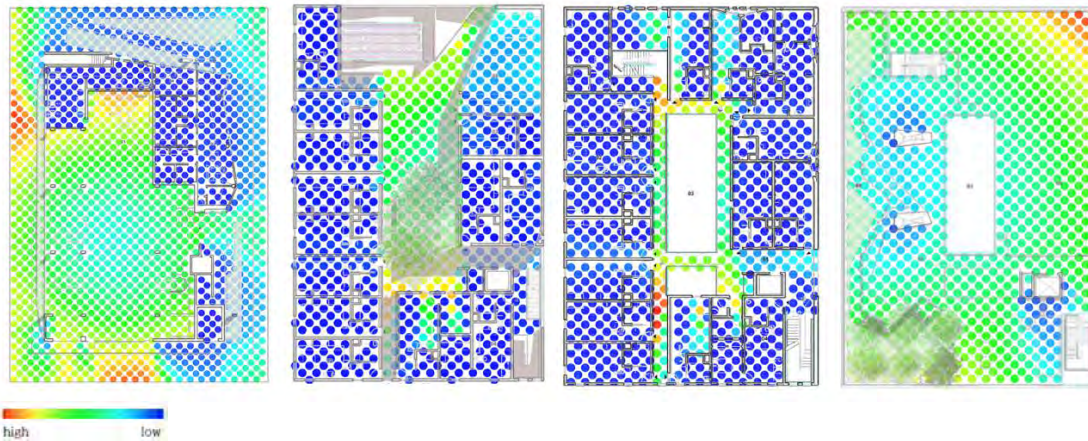

Figure 6: Visual Exposure of Floor Plan (First, Second, Fifth Floor and Roof garden)

3.2.2. Visual Exposure (VE)

The first floor was designed with piloti and support facilities were arranged along with the parking lot to create a space with the highest VE and the first recognition of residents and visitors. However, the northern office space was designed with glass, so it was expected that it would communicate with the outside and give a sense of openness, but the VE value was not high. In particular, considering the low VE of the movement line approaching the stairs inside the building, it can be said that the privacy of the residents is guaranteed because it is not easy to access the upper floors when people visit from the outside. A high VE in a parking lot means a lower risk of crime because the space is more likely to be monitored by others. The high VE of the second-floor courtyard means that this space is very visually exposed. It is a space that many people, including residents and visitors, pass through, so it can be judged that a lot of exchange can take place here. Also, since the community space in the northeast shows the second highest VE value after the courtyard, it can be inferred that this space, including the courtyard, is an appropriate space for people to meet. The corridor space connecting the dwelling units connected from the 3rd floor is not blocked by walls or glass and is designed with a handrail, so you can see the courtyard of the 2nd floor or face the opposite hallway, which allows for a visual exchange between the residents. It has a high VE value. The 5th floor has a corridor that overlooks the courtyard of the 2nd floor and a bridge connecting the dwelling units on the opposite side, so this space shows a high VE value. The roof garden has the highest VE as most of it is an open space except for the formative elements that protrude like some walls.

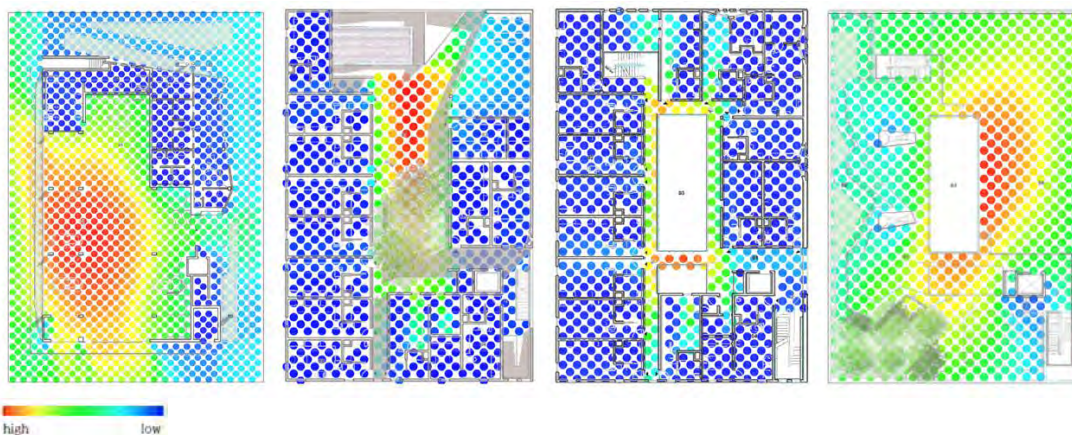

Figure 7: Visual Exposure of Floor Plan (First, Second, Fifth Floor and Roof garden)

3.2.3. Integration and Connectivity

As a result of analyzing the degree of integration, it can be seen that the highest spatial hierarchy in this building is the north stairway connecting the 3rd and 5th floors. The vertical movement of the building can be understood as movement through the stairwells on the north and south sides and the elevator core on the south side. Among these circulation axes, the spatial phase was highest in the vertical movement line of the middle floor connecting the 3rd and 5th floors. It can be seen that the living space of the remaining floors except the first floor shows a moderate degree of integration and connectivity. The degree of integration is lowest in each dwelling unit where privacy is protected. In particular, the corridor space connected to the vertical circulation shows the highest degree of integration, and since most of the residential spaces on each floor are connected to the vertical circulation and the corridor space, the utilization of the corridor is expected.

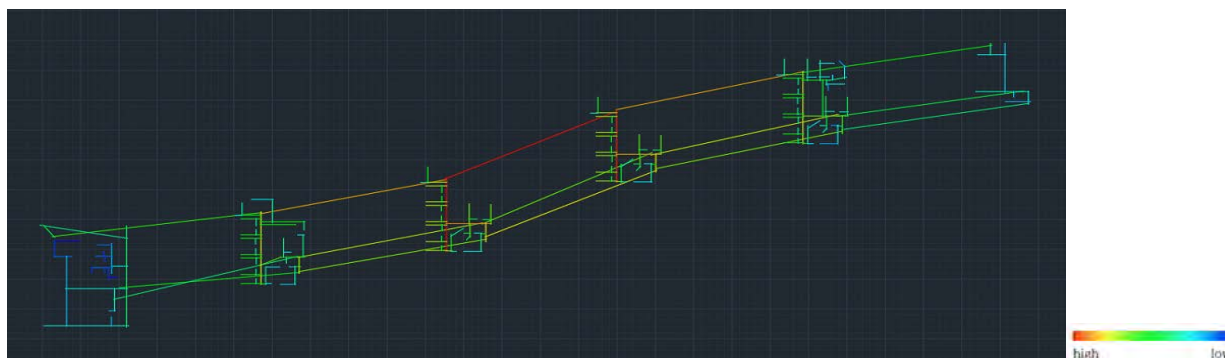

Figure 8: Integration and Connectivity of Each Floor

4.0 DISCUSSION

This study analyzed the spaces of two affordable housing developments in Los Angeles using VAE and Space Syntax. First, VA (Visual access) and VE (Visual exposure) of the space were accessed. In Space Syntax, the space was analyzed using integration and connectivity indicators. What the New Carver Apartments and The Six have in common is that the courtyard and hallway have the highest VA and VE values, which means that most of the activities take place in this space. The courtyard is located at the center of the building and the corridors are arranged so that the courtyard can be seen. Being visually open, the courtyard plays the most important role in this building as the most appropriate space for residents to communicate and exchange with each other. Therefore, as can be seen from these two cases, it can be considered that not only residents but also visitors can safely live in the building. Although VAE cannot simultaneously show the visual analysis that occurs between each floor, it reveals the importance of the courtyard and the atrium in both buildings by inferring the visual exposure and observability of the void space. Through this VAE analysis, it is possible to identify the crime-prone space and the well-monitored space, and it can be an opportunity to quantitatively check which design elements in this building allow visual interaction.

The VAE analysis has a feature where only analysis of a single floor is possible. Through this analysis, the space with high VA and VE can be easily recognized in various places in the building as a whole, and the activities of people in the space can be observed well. In addition, a high degree of visual openness and visual exchange in various places are sufficiently generated, so a high activation of the space can be expected. An individual in a space with high VA and low VE can look around well, but an individual located in that space is less likely to be visually exposed, so it is a space with a relatively high probability of crime compared to other spaces. On the other hand, a space with a low VA and a high VE becomes a space that can be observed from all spaces, such as a courtyard in a building, and it is not easy to observe other spaces in that space, so it has characteristics suitable for public space. In addition, a space with low VA and VE is a space with very high privacy and a space with high physical closure due to low visual exposure from the outside. In general, it can be seen that dwelling units have lower VA and VE in residential buildings to offer more privacy for the residents.

The integration of Space Syntax can explain the importance of each space inside a building, and the higher the spatial integration, the easier it is to access the space. The form of space is important because accessibility is greatly affected by the number of direction changes rather than the physical distance. Therefore, in the design process, the designer can quantitatively check the hierarchy of each space by creating an axial diagram that shows the relationship between spaces in the spatial positioning stage. Through this work, the architect can design the location and shape of a space suitable for the purpose of each space and the program characteristics of each space from a macroscopic point of view. Therefore, it is possible to proceed with the efficient space design process while checking the centrality of the space through the integration analysis and analyzing the connectivity to examine how connected each space is.

CONCLUSION

Many affordable housing projects that have been built with a large number of dwellings over a set period of time and on a tight budget have shown a lack of design considerations. As a result, the stereotype that affordable housing is low-income housing has been established. So what do architects need to consider for affordable housing? Which part of the residential design and development process should be prioritized? This study suggests that introducing the two methods of Space Syntax and VAE at the beginning of the design process can shed light on the possibility to promote the design and development of affordable housing to improve the quality of life for residents. Of course, these two methods can be applied to the design and development of not only affordable housing but also other buildings in general. However, a new paradigm that aims to give new value to affordable housing, which has historically been faithful only to functions, and to improve the quality of life of residents and promote their various activities within the building, should be considered. Therefore, in the initial stage of the design process, many residents should be able to feel happy the units were “house-like”, and safety and peace-of-mind should be maintained through various social activities and exchanges of residents. All these factors should be taken into account in the design of affordable housing developments, and all of these considerations should result in homes that are a significant source of well-being for residents when planning the future of affordable housing in Los Angeles.

REFERENCES

- Archea, J. C. 1985. Special Issue: Crime and the Environment: New Perspectives. *Journal of Architectural and Planning Research*, Vol. 2, No. 4. pp. 245-259.
- Benedikt, M. L. 1979. To take hold of space: Isovists and Isovist fields. *Environment and Planning B*, Vol. 6 (1).
- Hanson, J. 1998. *Decoding Homes and Houses*. Cambridge: Cambridge University Press.
- Hanson, J. and Hillier, B. 1998. Space Syntax as a Research Program, *Viewpoint for Urban Morphology*, Vol 1, No. 3. McKinsey Global Institute. 2019. *Affordable Housing in Los Angeles*.
- Wright, G. 2014. Design and Affordable American Housing. *Cityscape* 16 (2): 69. Wurster, Catherine Bauer. 1957. The Dreary Deadlock of Public Housing. *Architecture Forum*.

ENDNOTES

- ¹ <https://www.hud.gov/>, U.S. Department of Housing and Urban Development.
- ² <https://www.mmaltzan.com/projects/new-carver-apartments/>, Michael Maltzan Architecture.
- ³ <https://brooksscarpa.com/the-six>, Brooks+Scarpa.

Housing Insecurity and Latinx Community Resilience in Small Towns in Mississippi

Silvina Lopez Barrera¹, Diego Thompson¹

¹Mississippi State University, Starkville, MS

ABSTRACT: During recent decades, rural communities in Mississippi have received immigrants from Latin America to work in agri-food industries and they have contributed to the diversity and well-being of small rural towns in Mississippi. However, like other immigrants working in the food system, Latinx immigrants and their families in rural towns often experience significant challenges such as social isolation, discrimination, and substandard housing conditions. On August 7th 2019, the U.S. Immigration Customs and Enforcement (ICE) conducted massive raids in six small towns in rural Mississippi, resulting in 680 Latinx immigrants arrested, the largest single-state immigration enforcement operation in U.S. history. The raids and the detentions of Latinx immigrants significantly impacted six small towns located near Jackson (MS). This paper examines the effects of the raids and the Latinx community resilience in the affected small towns in Mississippi. It explores Latinx community-based responses to challenges related to housing insecurity, evictions, and avoidance of using public space due to fear of immigration authorities and discrimination. Methods include fieldwork mapping and semi-structured interviews with community leaders, activists, organizations working with the communities affected, and individuals affected by the raids and involved in community responses. Although community-based resilient responses can facilitate resources for Latinx families, findings suggest the need for a systemic design approach and governmental commitment to address precarious housing conditions (overcrowding and substandard) and access to public space ensuring Latinx community's agency and their right to participate and transform the towns and the places they inhabit. This study aims to encourage communities to develop grassroots resilient design responses to support immigrants in rural communities by trying to make communities in rural U.S. more inclusive, diverse, and welcoming.

KEYWORDS: Housing Insecurity, Community Resilience, Latinx, Immigration Raids

INTRODUCTION

During recent decades, rural communities in Mississippi have received immigrants from Latin America to work on chicken plants (Stuesse 2016). Latinx immigrants working in agri-food industries have contributed to the diversity and well-being of small rural towns in Mississippi. However, like other immigrants working in the food system, Latinx immigrants and their families in rural towns often experience significant challenges such as lack of access to basic resources, social isolation, substandard and precarious housing conditions, discrimination, and labor and human rights abuses (see Fink 1998; Striffler 2005; Stuesse 2016; Keller 2019; Mares 2019; Thompson 2021).

On August 9th 2019, the U.S. Immigration Customs and Enforcement (ICE) conducted massive raids on chicken plants in six small towns in rural Mississippi, resulting in 680 Latinx immigrants arrested, the largest single-state immigration enforcement operation in U.S. history (U.S. Department of Homeland Security 2020). The raids and the detentions of Latinx immigrants were carried out in Bay Springs, Carthage, Canton, Morton, Pelahatchie and Sebastapol, significantly impacting these small rural communities located near Jackson, MS (see Figure 1) (Fowler 2019). As multiple media outlets from Mississippi and the national media have shown, these raids had devastating consequences for these communities, especially for the Latinx families and communities in Mississippi, which are still struggling to overcome the social and economic crises created by the detention of their community members. In addition to the impacts from the raids, Latinx immigrants are struggling with the effects of the COVID-19 pandemic that is disproportionately affecting communities of color.



Figure 1: Map of the Mississippi towns affected by the 2019 Immigration Raids. Source: Author, 2021.

This study examines the effects of the raids on the Latinx communities of the six communities mentioned above that were directly affected, and also in Forest (MS), a minority-majority community near Morton (MS), where many Latinx families live. Previous studies (e.g., Grey et al. 2009; Sandoval 2014) in the U.S. examining the effects from large immigration raids in small rural communities (e.g., Postville in Iowa) have shown the negative impacts that these significant disruptions have, not only within the immigrant communities but also on the overall wellbeing of the communities affected.

Additionally, this research provides an insight on community resilience strategies developed to overcome the problems created by the raids, to facilitate resources for Latinx families, and to create inclusive and welcoming communities. Existing literature highlights the relevance of community resilience, showing that it is critically important to identify community responses after immigration raids (see e.g., Sandoval 2014) and/or other disturbances (see Thompson and Lopez Barrera 2019a; 2019b) affecting rural communities in historically marginalized places like rural Mississippi. The identification and/or adoption of community strategies to foster inclusion and better access to resources among Latinx immigrants will contribute to the work of scholars, activists, policy-makers, and/or community residents working on similar problems and contexts in the U.S.

1.0 METHODS

Methods include fieldwork mapping and semi-structured interviews with community leaders, activists, organizations working with the communities affected, and individuals affected by the raids and involved in community responses. In-depth interviews were conducted with a semi-structured questionnaire to community members affected by the immigration raids and activists and organizations that have worked directly with the Latinx communities on their recovery after the raids and responses to overcome their challenges. Using purposive snowball sampling strategy, we identified other key actors (Esterberg 2002, Neuman 2003) actively involved in matters and decisions about solutions to problems generated by the raids on the Latinx communities affected.

Data collected through semi-structured interviews includes effects of the raids on the Latinx communities and the local responses that have been developed to overcome social (e.g. discrimination, isolation, stigma, etc.) and structural challenges (e.g., legal problems, institutional discrimination, socio-economic challenges, housing challenges, eviction, etc.) faced by members of the Latinx communities affected by the raids. This methodology allowed to identify whether and how community responses have contributed to the empowerment of Latinx community residents (i.e. making decisions about locally available resources based on their needs and desires), which is a critical factor to be considered looking at social integration of immigrants and the overall community well-being in a long-term. Additionally, secondary sources were used to complement the data collected from interviews on the impacts of the raids.

The innovative approach used for the design of this research to look at the disruptions created within these Latinx communities of Mississippi affected by the raids and the responses that could improve their wellbeing and social equity, will generate an important precedent that could inform future studies or actions to address similar problems affecting immigrants and/or other minority groups in rural communities in the U.S.

2.0 THE DAY OF THE RAIDS: DISRUPTION ON EVERYDAY LIFE

The disruption of the U.S. Immigration Customs and Enforcement (ICE) conducted massive raids on August 9th 2019 had immediate negative effects and long-term consequences not only for the affected immigrants and their families but significantly impacted the entire communities in Bay Springs, Carthage, Canton, Morton, Pelahatchie and Sebastapol. Community organizers who assisted the immigrant communities immediately after the raids emphasized the significant trauma and economic disruption for the all the affected small towns, where suddenly over six hundred households lost their main income.

"It was horrible, horrible. In these communities, the five communities that were most impacted by the raids are very small. Those poultry plants are the major employers and they arrested six hundred and eighty some odd people. Just over six hundred families suddenly without the main wage earner and no way for that person to replace those lost wages. So economically, it was devastating. ...And it took- There are still some people in detention now. And it's been a long time, well over a year since the raid. A lot of people, a number of people have been deported. It's it was just devastating, devastating to those families and also devastating to the to the economy in general of those towns, because they those plants were not able to replace those workers right away." (community organizer)

One of the most significant disruption and long-term consequences of the immigration raids are the trauma inflicted in the children of the affected immigrant families. Community members, activists and organizers described trauma in children as one of the worst consequences. The raids took place while most of the children were in class on their first day of school. When children started to return home from school, they found out their parents had been detained and they did not have anyone to care for them. Community organizers and activists describe these extremely traumatic events for the children and their detained parents:

"...It was the first day of school of the new school year. The children went off to school in the morning and without knowing that anything had happen, they came home in the afternoon to find one or both of their parents gone. And not knowing when they might be back. It was extraordinarily traumatic for those children and for their parents as well, knowing that their kids were left home and not knowing, you know, who was going to be taking care of them..." (community organizer)

The communities and local organizations were unprepared for massive raids like this one, there was not experience in the state of Mississippi with large scale immigration raids. As a local educator describe the day of the immigration raids and the school release of the children:

"It was a very difficult day for the children, suffering, they did not understand what was going on. The children said 'my dad was working, my mom was working'...That day our goal was to make sure the majority of the children could go to a home where they had a familiar face, an aunt, an uncle, a babysitter...We didn't have a plan." (educator)

Therefore, there was lack of plans in place to address the emergency of the situation involving families and children being separated. Amidst the chaotic and disturbing situation, grassroots community organizations and local churches rapidly started to assist the children and separated families trying to find family caregivers for the children while their parents were in detention. However, two years after the raids, parents of affected children highlight the trauma and sadness these events still have on their children.

3.0 LATINX HOUSING INSECURITY AND COMMUNITY-BASED RESPONSES

This section explores housing challenges of the Latinx community and community-based responses after the immigration raids. Housing precarity in the Latinx community are augmented by barriers to access to affordable and adequate housing.

3.1 Housing Precarity

Latinx low-income households often experience rental cost burden and barriers to access to adequate and affordable housing quality. According to the U.S Department of Housing and Urban Development, "Affordable housing is generally defined as housing on which the occupant is paying no more than 30 percent of gross income for housing costs, including utilities." [1] Like in the rest of the United States, the 30% rule that defines housing affordability represents housing rental cost burden for low-income households because the remaining 70% of the household income is usually not enough to cover for their living expenses including food, healthcare, education, transportation and utilities, among other everyday expenditures. [2] Studies on housing affordability in the United States show that low-income households that dwell in low quality housing conditions tend to pay more than 50 percent of their income in housing. [3]

According to the Joint Center for Housing Studies, in 2021 the state of Mississippi has the highest concentration of renters that are behind housing payment in the nation, 27percent of renter households in Mississippi owes rental payment and are at risk of eviction notices (Joint Center for Housing Studies of Harvard University 2021, 4-5). Additionally, at the national level, more than 50 percent of Latinx household renters are cost-burdened households spending 30-50 percent (or more than 50 percent) of their income to pay rent (Joint Center for Housing Studies of Harvard University)

The barriers to access to adequate and affordable housing in the Latinx community are interconnected with their immigration status and their limited access to resources, resulting on access to a limited and deteriorating housing stock with unsafe and unhealthy conditions expensive to restore and maintain by landlords. Because of the housing demand of Latinx renters, landlords are able to make profit from dilapidated properties and take advantage of the situation. As a community organizer explains:

"...The houses are old and semi-destroyed. For the landlords the immigrant population, that came into the towns to work on the chicken plants, has been a blessing because landlords keep renting rundown and unmaintained properties..." (community organizer) Paradoxically, this precarious housing stock become the primary rental housing supply for low income residents that need access to affordable housing (see figures 2 and 3). Housing precarity in the Latinx households is affected by the marginalization of the community normalizing the 'invisibility' of the Latinx housing precarity from public debate.



Figures 2 and 3: Affordable housing units in the towns affected by the 2019 Immigration Raids. Source: Author, 2021.

According to community organizers, a great number of the Latinx community in the affected towns lives in mobile homes typically placed in trailer parks (see Figure 4). Is common to observe two or three families sharing a housing unit. According to community organizations that advocate for the Latinx community, immigrants who rent housing have very limited options for affordable housing. Undocumented Latinx immigrants are not eligible for any benefits of any of the housing assistance or subsidized programs. This reality gives them very limited options and are forced to rent dilapidated properties enduring substandard housing conditions. As a community organizer mentioned, the are many of these houses that expose serious environmental and health risks.

"...Our community live in what we called the "trailas"... many of these houses are dangerous environments for the health, especially on drink water...there are issues of lead contamination..." (community organizer)

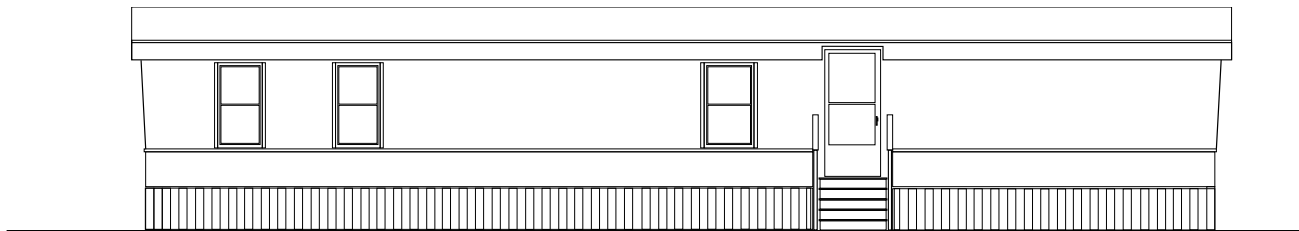

Figure 4: Mobile home units, typically rented by Latinx tenants, referred as "trailas" by the Latinx community. Source: Author, 2021.

3.2 Post-Raids Housing Adaptations: Community-Based Responses

Immediately after the raids, the Latinx immigrant community faced uncertainty and fear of deportation. Additionally, one of the major stresses for the Latinx community was to ensure access to basic housing and basic needs. For hundreds of Latinx households in the small towns where the raids took place, the immediate effects of the raids were the loss of jobs. In the majority of the Latinx families that were directly affected, their primary or sole income earner was detained and facing deportation. Additionally, there was a great number of families that were not able to return to work because of fear of detention. Although, many Latinx immigrants were not detained because raids did not occur during their shifts, they lost their jobs because their employers did not allow them to return to work. For families with both detained and non-detained family members, the raids represented a huge economic and financial disruption.

The loss of jobs and its financial disruption prompted a series of pressures on the housing situation of the Latinx community. In general, in any situation without a substantial safety-net, job loss is followed by household income loss. Next, the situation escalates to eviction notices and foreclosure notices. For the general population, there are subsidized housing programs that are able to assist renters to secure housing. However, the Latinx undocumented immigrants lack of access to any formal subsidies or housing assistance programs. Consequently, when Latinx undocumented immigrants are not able to afford their rent they are highly vulnerable to housing insecurity depending only on the landlord-tenant relationship. Community organizers have expressed that in the face of the raids some landlords made agreements with their tenants:

"...in the moment when everything happened, logically was a moment in which the landlords also collaborated...they made arrangements with their tenants. It is necessary to understand that our community doesn't live in 'casas señoriales' (fancy homes), is quite the opposite..." (Community organizer)

In the face of the impacts of the raids including family separation, involuntary displacement, income loss and financial burdens, community and grassroots organizations emerged to provide assistance to the affected Latinx families. A coalition of local organizations was formed with the support from organizations at the national level. This coalition coordinated efforts to provide legal assistance, access to basic needs and secure housing.

The local organizations quickly developed fundraising efforts and receive donations from all over the country to help Latinx families in need. These efforts allowed to provide temporary rent assistance funds to the families that were at risk of evictions. Temporary rent assistance was provided during 6 months after the raids to primary to households directly affected by the raids in two different ways: 1) to households that had family members detained, or 2) to households where family members had been detained and released with ankle monitors and consequently were not able to return to work.

"Many of those families are still living there, but without an income or without anything close to the income that they have before. And so if it had not been for the coalition and churches and individual donations that helped to get people's rent and utilities paid and kept food on the table for people, I don't know what would have happened to all those families. They would have been a real catastrophe. It was a catastrophe already, but it would have been unimaginable." (community organizer)

Although the rent assistance provided a fundamental solution for the recipient households, there were a great number of Latinx households that were not able to receive the rent assistance. These households involved family members who were not detained but they lost their job and income due to the raids. In many cases, the employers did not allow workers to return to their workplace and Latinx workers experience fear of detention. Additionally, the rent assistance had a relatively short-term duration depending on the fundraised resources.

After six months of the raids, most of the resources were exhausted, and people with ankle monitors were still not able to return to work. These Latinx households and families were in precarious conditions of dependence and they had to adapt their housing solutions in different ways. One of the most typical housing adaptation strategies for Latinx families who were not able to afford the rent was to move with other family members or friends. Hence, this type of housing solution augmented the risk of overcrowding conditions on housing rental units that were already unmaintained.

"I know of people who have moved to others people homes because they were not able to pay their rent or because they don't have all the money for the rent. I know of people that have to share a house this way. A lot of families because of the same, because their father was detained or because their mother was detained because of the raids... or simply because now there is no place to work..."(Latinx community member detained by the raids and released with ankle monitor - translation by author)

Another effect of the raids on housing insecurity, was displacement of Latinx families from the affected small towns in Mississippi. According to community organizers, after the raids a great number of families left the state of Mississippi and relocated to other states where they had family members who could accommodate them.

"...A lot of people have left; a lot of people have moved to other states... but a lot have tried to find a way to continue subsisting."
(Latinx community member detained by the raids and released with ankle monitor - translation by author)

3.3 Housing Confinement and Public Space Avoidance

After the raids, the Latinx community was deeply traumatized. In addition to the struggle to access to adequate and affordable housing, the Latinx community experienced fear of using public space and access to basic service facilities. Community members expressed they avoided unnecessary exposure in public spaces, and they limited their presence to places they feel safe.

COVID 19 and the fear to immigration authorities exposed the Latinx lack of access to basic health care. Although, during the pandemic most of the Latinx workers were considered essential workers, they did not have any access to health care. The Latinx community was the first community affected by COVID-19 in the small-towns where the raids took place. A community organizer explained how the Latinx workers were considered essential labor during the COVID 19 lockdown and had to continue work in the chicken plants risking their health and wellbeing for the greater good.

"... the Hispanic community was the first affected in here. Because they had to continue to go to work. During the raids, they wanted to deport them from this country. During COVID they gave them a letter saying they were essential workers and if the police stopped them, they could show that letter because they must go to work... It is like a double standard, now with COVID they were essential...Because if they don't work there is no chicken in the table... So, hispanic community were the first ones that were infected..." (community organizer)

The post- raids avoidance of using public space due to fear of immigration authorities and discrimination was amplified by the public health risks of the COVID-19 pandemic. Like in the rest of the U.S, the barriers to access to adequate housing and health care became and continue to be critical issue for the Latinx community in Mississippi that endure overcrowding and substandard housing condition. As community organizers stated,

"I've heard the term "self-deport"...so I suppose in that way, lost their housing and they chose to leave...I also know many people who were confined to their home because of the trauma or fear now with COVID not having health care, housing becomes all the more important..." (community organizer)

"fear of presenting yourself to a to a medical facility and not knowing what's going to happen and then the ability to pay for it because you can't get insurance..."(community organizer)

The immigration raids of August 2019 traumatized families and worsened the existing difficulties the Latinx community endures on daily basis. In the towns of the raids, the Latinx community lack of access basic resources and were not prepared for a shock of the magnitude of mass immigration raids. In this context, grassroots community organizations emerged to provide short term emergence assistance and they contributed to expose the injustices, the trauma, and substandard living conditions the Latinx community was enduring in Mississippi.

4.0 CONCLUSION

Prior to the massive immigration raids, the Latinx community challenges were mostly concealed and absent from public debate in the state of Mississippi. The raids exposed and exacerbated the injustices the Latinx community were already enduring at the time of the raids; including their vulnerability to housing insecurity and evictions, their barriers to access to basic services and their trauma and avoidance of using public space due to fear of immigration authorities and discrimination.

Although community-based resilient responses facilitated resources for Latinx families after the immigration raids, findings from this research suggest the need for a systemic approach and governmental commitment to address precarious housing conditions (overcrowding and substandard) and access to public space ensuring Latinx community's agency and their right to participate and transform the towns and the places they inhabit.

Finally, this study reveals barriers and the vulnerability of the Latinx community that could limit their community resilience and social integration in small towns in Mississippi. The extreme hardships and trauma caused by the massive immigration raids deeply impacted the whole community. As communities continue to experience the negative effects of immigration raids, it is important to develop grassroots initiatives that could allow communities not only to address their short-term needs but to thrive in the long-term future and to support immigrants in rural communities by trying to make communities in rural U.S. more inclusive, diverse, and welcoming.

REFERENCES

- Desmond, Matthew. 2016. *Evicted: Poverty and Profit in the American City*. New York: Broadway Books.
- Esterberg, K. 2002. *Qualitative methods in social research*. Boston: McGraw Hill.
- Fink, Deborah. 1998. *Cutting Into the Meatpacking Line: Workers and Change in the Rural Midwest*. The University of North Carolina Press.
- Fowler, Sarah. 2019. *Where are my parents? School on standby to help children in aftermath of ICE raids*. August 08. Accessed November 2021. <https://www.usatoday.com/story/news/nation/2019/08/08/ice-raids-mississippi-undocumented-workers-arrested-kids-worry/1952572001/>.
- Joint Center for Housing Studies of Harvard University. n.d. *Renter Cost Burdens by Race and Ethnicity*. Accessed November 2021. https://www.jchs.harvard.edu/ARH_2017_cost_burdens_by_race.
- . 2021. "The State of the Nation's Housing 2021." Accessed November 2021. https://www.jchs.harvard.edu/sites/default/files/reports/files/Harvard_JCHS_State_Nations_Housing_2021.pdf.
- Keller, Julie C. 2019. *Milking in the Shadows: Migrants and Mobility in America's Dairyland*. New Brunswick: Rutgers University Press.
- Mares, Teresa M. 2019. *Life on the Other Border: Farmworkers and Food Justice in Vermont*. Oakland, California: University of California Press.
- Mark A Grey, Michele Devlin, Aaron Goldsmith. 2009. *Postville U.S.A: Surviving Diversity in Small-Town America*. Boston, MA: GemmaMedia.
- Migrant Legal Action Program. 2016. *Migrant Legal Action Program, Farmworker Housing*. Accessed August 22, 2018. <https://www.mlapp.org/housing-1>.
- Neuman, W.L. 2003. *Social Research Methods: Qualitative and Quantitative Approaches*. New York.: Allyn and Bacon.
- Sandoval, Gerardo. 2014. "Immigrant integration models in "illegal" communities: Postville Iowa's shadow context." *Local Environment* 20 (6): 1-23.
- State of Mississippi Development Authority. 2014. "Analysis of Impediments to Fair Housing Choice."
- Striffler, Steve. 2005. *Chicken The Dangerous Transformation of America's Favorite Food*. New Haven and London: Yale University Press.
- Stuesse, Angela. 2016. *Scratching Out a Living: Latinos, Race, and Work on the Deep South*. Oakland, California: University of California Press.
- Thompson, Diego, and Silvina Lopez Barrera. 2019. "Building collaborative governance and community resilience under socio-spatial rural disparities and environmental challenges." *Community Development Practice* 23: 8-16.
- Thompson, Diego. 2021. "Building and transforming collective agency and collective identity to address Latinx farmworkers' needs and challenges in rural Vermont." *Agriculture and Human Values* 38: 129–143.
- Thompson, Diego, and Silvina Lopez Barrera. 2019. "Community resilience and collective agency under significant changes in the natural and built environment: a community capitals framework approach." *Local Environment: The International Journal of Justice and Sustainability* 24 (12): 1156-1177.
- U.S Department of Housing and Urban Development. n.d. *Glossary of Terms to Affordable Housing*. Accessed February 23, 2021. <https://archives.hud.gov/local/nv/goodstories/2006-04-06glos.cfm>.

ENDNOTES

^[1] U.S Department of Housing and Urban Development. n.d. *Glossary of Terms to Affordable Housing*. Accessed February 23, 2021, <https://archives.hud.gov/local/nv/goodstories/2006-04-06glos.cfm>.

^[2] Michael E. Stone, "Housing Affordability: One-Third a Nation Shelter-Poor," in *A Right to Housing: Foundation for a New Social Agenda*, ed. Rachel Bratt, Michael Stone and Chester Hartman (Philadelphia, PA : Temple University Press, 2006): 38–60; Michael E. Stone, "Shelter Poverty: The Chronic Crisis of Housing Affordability," *New England Journal of Public Policy* 20, no.1 (2004): 107–119; Whitney Airgood-Obrycki, Alexander Hermann, and Sophia Wedeen, "The Rent Eats First: Rental Housing Unaffordability in the US," *Joint Center for Housing Studies Harvard University* (January 2021): 1-36; Matthew Desmond, *Evicted: Poverty and Profit in the American City* (New York: Broadway Books, 2016), 293-314.

^[3] Sung-jin Lee, Kathleen R. Parrott , and Mira Ahn, "Exploring Housing Challenges of Low-Income Minority Populations in the Southern United States," *Cityscape* (American Housing Survey, US Department of Housing and Urban Development) Vol. 14, no.1 (2012): 94.

Neighborhood Design with Community Engagement

Julia W. Robinson¹, Timothy Griffin², Jamil Ford³, Cathy Spann⁴, Brandon Champeau⁵

¹School of Architecture, University of Minnesota, Minneapolis, MN

²Minnesota Design Center, University of Minnesota, Minneapolis, MN

³Mobilize Design & Architecture, Minneapolis, MN

⁴Jordan Area Community Council, Minneapolis, MN

⁵United Properties Developers, Minneapolis, MN

ABSTRACT: Minneapolis, known for its wide disparities, includes the North Minneapolis neighborhood with inequities in youth incarceration, income, education, health, home ownership, homelessness; and 80% BIPOC citizenry, hit hard with COVID, and George Floyd's death. Northside residents seek changes that reduce poverty and neighborhood isolation. The design studio goal was to co-create with local youth and residents a design that employs public realm investment to reconnect the segregated neighborhood to city, with mixed-income housing, financing that enables wealth-building, and human services. The project research team comprised a neighborhood organization executive director, a community advocate and architectural firm owner, the VP of a development organization, and from the university, experienced in urban participatory design, a researcher, and a design professor of architecture. An advisory group of experts informed the project. Presently, streets and highways block access to three potential neighborhood assets, downtown, the local river, and a city park. The first year of a three-year project aimed to reconnect the neighborhood to adjacent areas while addressing housing and social services as topics of focus. Geodesign, a GIS-based approach to sustainable participation was the tool of engagement in community meetings, addressing ten topics or urban design layers. Several factors required changing the original direction of the studio, including: holding community meetings online instead of in person, a difficulty in recruiting youth interns, strong community interest in key ideas, and a resistance among the community participants to normative urban design practices. The paper describes the engagement process, the changes in approach and final designs, answering such questions as: How did recruitment and retention work? How and why did the design approach change? What was learned from the participatory process? How did the community and university students work together? How did youth participate? What were community aspirations? How did designs address the neighborhood disparities?

KEYWORDS: Community, Equity

INTRODUCTION

Minneapolis has high levels of income, health care, education, but also high disparities between white and Black populations, due to segregation from redlining and other discriminatory housing practices. Today Northside neighborhoods have significantly lower income, high school graduation rates, home ownership, health indicators and business investment than white neighborhoods (LISC 2014).

In the 1960s, the I-94 freeway divided Northside Minneapolis neighborhoods from the Mississippi River. Disadvantaged by poverty, inequitable wealth accumulation and inequitable public investment, these neighborhoods remain isolated from the rest of the city. Unlike riverside neighborhoods to the south that incorporate the Great River Road, accessible parkland, and pedestrian and bicycle paths along the river, this neighborhood's riverside area remains industrial, with unpaved streets, no sidewalks, no parkland, disorganized pedestrian and bicycle paths, and access blocked by the below-ground highway, reflecting its great disparities. The studio's goal is to reconnect the neighborhood along the river and through the neighborhood to the Minneapolis Park System Grand Rounds. By taking a comprehensive approach that addresses housing, education, health, culture, jobs, regenerative design, ecology and more, we will address not just the vision, but the means of achieving it. The history of city planning in North Minneapolis is controversial because the community continues to see the results as not benefitting the Northside residents, but rather the already existing developers and power structure. (Bell & Bauknight 2020)

Typically, Minneapolis urban designs are developed by the city and the community responds in a series of meetings. Minneapolis urban planners developed a city-wide urban plan called created Minneapolis 2040, and then proposed applying it in North Minneapolis in the Upper Harbor Terminal Project (UHRP). Now being implemented, UHTP is located on the river north of undeveloped site chosen for the studio. The city hired a developer to work with community members to generate a design. Although the community was engaged in the design, in the implementation process, the community ideas were subverted and outside investors gained from the development, rather than

members of the community (Bell & Bauknight 2020). In contrast, the goal of the studio was to develop an agreed-upon plan that challenges the status quo of the marginalized community of color. The outcome was intended to be a research-informed, equitable, regenerative, community-developed-and-supported plan that would powerfully communicate the parameters of the Northside's transformative vision to the city prior to the city's planning process for this site. The intention is to get ahead of the city, so they are responding to the community design, rather than the reverse. While the research team saw this as a three-year project for the studio, we anticipated that at the end of the first studio we would have a first draft co-designed plan that the community members would agree upon.

1.0 THE RESEARCH TEAM

Julia Robinson, the class instructor, worked with community participants for two years, in a similar studio that explored the architectural implications of preventing juvenile detention, (Robinson & Price, 2021). She met Jamil Ford, owner of Mobilize Design Architects and Planners, when he organized a site visit for the class. Having become familiar with North Minneapolis through her work, she saw the undeveloped site along the river at the east of the neighborhood as a possible site of intervention that could transform the neighborhood using community-based planning. She mentioned her interest to Mr. Ford. Having witnessed the problems with the process of the Upper Harbor Terminal Project, he agreed that this site had potential leverage power for neighborhood change, and Robinson and Ford created a research team to implement the project. To represent the community's perspective in the design process they sought to recruit 20 adult community members and six youth interns aged 18-26.

The research team consisted of Ford, Robinson, Cathy Spann, Executive Director of an active North Minneapolis neighborhood organization, Timothy Griffin, expert on Geodesign, and Brandon Champeau, Senior Vice President of United Properties, the controversial developer for the UHT project, which provided matching funds for several grants the team sought funding for. The neighborhood group would provide stipends for community and youth participants, and the School of Architecture would support the studio. The grant funds would provide support for consultants, for research assistants, and for developing a community exhibition at the end of the project. As a part of the grant application process, the team sought, and received support from a variety of additional organizations, including the Center for Sustainable Building Research, the Minnesota Design Center, AIA Minnesota, and individuals at the Minneapolis Park Board and the Minneapolis Community Planning and Economic Development. Representatives from these and other organizations agreed to participate as part of an Expert Advisory Group, that would help educate the students about urban design issues and serve on design studio reviews.

Although no additional funding was provided other than what was originally to be matching funds, the project proceeded with support for research assistants, stipends, with minimal support for consultants. BIPOC design professionals who practice regionally were invited to participate on design reviews as well.

2.0 THE PLANNED STUDIO STRUCTURE

The design studio was a research-based class for undergraduate pre-professional students in their final year of study. In this studio, students are given a taste of working in a professional situation. In a fifteen-week semester, informed by community and research experts, students were to work with community members and youth interns to develop a shared neighborhood design in the first half of the semester. This design was to be informed by Twenty-first Century Development Standards (21CS) developed by AIA Minnesota (American Institute of Architects Minnesota et al 2014), and use the Geodesign method (Steinitz 2012), previously implemented in similar projects by team member Griffin with the Minnesota Design Center. University students would prepare work in response to community feedback, working one day a week with neighborhood youth interns. The project affiliated with the Robert L. Jones University Research and Outreach-Engagement Center (UROC) located in North Minneapolis, where we held classes on many Wednesdays.

During the first half of the semester, students and interns would 1) study precedents (regenerative and equitable urban designs, taken from the 21CS and other sources), 2) complete an urban analysis of the neighborhood using the many online sources of data for the ten Geodesign layers of information (water, agriculture and food, green space, energy, housing, institutions, industry and commerce, transportation, economic development and equity), 3) develop design innovations options for each Geodesign layer, and with the community 4) using this information, co-design urban proposals that addressed social and ecological challenges in community meetings. Timothy Griffin, our expert on Geodesign, would advise us on how to present materials to the community, as the student and intern work was to be generate discussions with neighborhood participants at a series of community meetings. Since the community meetings were outside of class hours, students could not be required to attend the meetings, but those who could, would join to present their work and collaborate on design. Meeting in person, community participants would, at different meetings, discuss research, innovative designs and policies, and negotiate a final developed design. These community meetings were to be held in the neighborhood, or if necessary, at meetings on the internet.

In the second half of the semester, students were to develop design ideas from final urban design, at the scale of building, landscape, or urbanscape that would demonstrate how the design might be implemented.

3.0 THE PLANNED COMMUNITY ENGAGEMENT PROCESS

The implementation plan was for the community participants to co-create with students and interns an urban design. Young adult interns were to participate in an orientation session, to work with the studio one day a week, and to attend community meetings. The co-design process was to take place at 5 in-person meetings based on the Geodesign process, each lasting 90 minutes in the first half of the semester. Student and intern work would serve as the basis for discussion and decision-making, as community participants would work in groups to discuss and evaluate design options, and create designs by locating selected design options on maps of the urban site

In the second half, based on the co-designed plan, and participant ideas, the students and interns would develop designs to illustrate what the implemented plan might be like, and to present the design proposals (buildings, systems, or landscape elements) to community participants at two additional 90-minute meetings, one for feedback and the other to see the final design. The 90-minute meeting time was chosen because that was the time between the end of design studio at 5:30, and the beginning of Bible study at 7:00 pm.

Community participants were to be recruited starting in June by the Executive Director of a neighborhood organization. The young adult interns were to be recruited by a person experienced in organizing and instructing youth programs for the schools, park board and the university.

4.0 THE ACTUAL COMMUNITY ENGAGEMENT PROCESS & ITS EFFECT ON THE STUDIO

Although the recruitment of community participants and interns was supposed to begin in the spring, due to various unavoidable circumstances, the process did not begin until mid-summer. Additionally, without the funding originally sought, we reduced the number of participants. By our first meeting in August, we surpassed our minimum recruitment goal of ten community participants, however as church members, the participants were older and somewhat conservative. Additionally, we were only able to recruit one intern, someone who had some architectural education. This allowed us to change the participation to adjust his participation to include review of projects as well as attending community meetings. Toward the end of the semester, we were able to invite five young adults to review the student projects. They provided a very different perspective from the community members, more open to contemporary designs especially on the river, and to cooperative developments.

Due to COVID restrictions, between August and November, no community spaces were available for meetings of 20 or more people in North Minneapolis. As a result, all the planned community meetings were held on Zoom. This, combined with the limitation of the 90-minutes, greatly impacted the ability to co-design during meetings. At each meeting we had a brief time for check-in and introducing the procedure at the beginning of the meeting, discussion during the meeting, and at the end a brief time for summarizing what was learned.

Meeting #1- Orientation

The first community meeting with community members, research team members and the intern, went as planned with introductions of all participants, and of the project. This meeting did not include students, as it was held in August, before the semester had begun. Community participants presented their goals for the community and ideas about how developing the river site might be done so that the neighborhood would be a destination rather than a pass-by area.

Meeting #2- Neighborhood Research

At the second, September community meeting, students presented their research on the ten Geodesign topics for North Minneapolis neighborhood and the city. The research was grouped into 6 subject areas. If the meeting had been in person, we would have had three group discussions with each group covering two topics. The circumstances led us to instead have two breakout rooms. Because of the limited meeting time, and the need to have discussion, each student team summarize their work in a 2-minute video that was presented after the check-in. Subsequently everyone in the meeting was assigned to the two breakout rooms for the discussion. In each breakout room one or more student team members were present to respond to informational questions were raised in discussion of the research. The community members were surprised by many of the findings, and clarified their concerns, and community goals. They were very interested in research that compared their neighborhood to others in the city. The main issues they raised were safety, healthy food access, homeownership and wealth building, creating a community center and a concern that the level of asthma in their neighborhood was the highest in the city, likely due to the proximity to the industrial area.

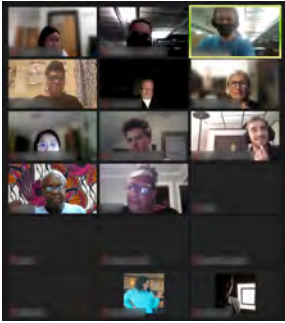

Image of Zoom Meeting #3

Meeting #3- Design & Policy Innovations

Following the Geodesign approach, with feedback from our intern, each student developed ten design innovations in thirteen topic areas. Similarly, to the previous meeting, each student created a 3-minute video summarizing their innovations. They also made a poster with all of the innovations on it. But this time, half were presented in each breakout room, and community members, commented on the innovations, explaining which they thought were applicable in their neighborhood. One breakout group voted on options they thought would be good to pursue. The other group discussed several ideas, especially food and housing. The community participants were most interested in innovations that were developed in their neighborhood or relatively local. They especially appreciated innovations that were associated with organizations they knew.

Meeting #4 – Four Urban Designs

Typically, at the fourth Geodesign Meeting, participants are assigned to four groups representing different points of view (such as business, resident, government, and non-profit agency). Then each group chooses innovations they like, placing them where they think they will work, on maps of the neighborhood. At the previous meeting, the participants became familiar with only some of the innovations. Furthermore, asking people to place innovations on maps, which would be simple in person, would not work well on Zoom. So, we decided to create four plans that represented the goals of the residents (design for health and wellness, design for youth, design for sustainability and design for community), and to assign the innovations that residents liked to one of the four designs. Each team was asked to show how the innovation would work in the existing neighborhood context and how it would work on the river site. The drawings used to delineate the ideas were bird's eye axonometric drawings. We prepared a poll for attendees to tell us what they liked about the different schemes. Once again, each team created a short video, two of which were presented in each of the two breakout rooms for discussion, with students present to answer questions and hear the resident response.

The community participants did not respond well to the plans, especially the designs for the new area along the river. In one breakout room participants filled out the polls on the designs, but in the other this was not done. For many, it was more important to improve the existing neighborhood than to plan for new innovations on the river site, and even designs that tied the new development to the existing area were not appreciated. They commented that the designs did not appear to take the residents' ideas seriously and looked as if we were playing "Sim City" with our designs. Our approach was considered top-down rather than bottom up. One person said that we were applying the White person's way of urban design. We had divided the urban design into variables and were recombining them rather than developing integrated designs. We had a review earlier that day where design professionals had liked the designs and realized our normative planning approach might be important to question.

Our designs generated an urban scale plan that used bird's eye view without including eye-level views and sketches. It might have been better received had we included eye-level views and sketches, and certainly if the participants had chosen and located the design elements themselves. Considering how to approach the remaining six or seven weeks of the semester, we decided that developing a comprehensive urban design for the area would not be responsive to the residents' concerns. Instead, we focused on designing particular projects that show how the residents' ideas might be applied in the neighborhood and on the river site.

Meeting #5- Asking Questions

The fifth meeting in the Geodesign protocol is where the community members negotiate a shared design. Having abandoned the idea of a shared urban design, the class decided the students would organize this meeting to find answers to questions that had arisen about different aspects of the neighborhood and the residents' ideas. They compiled a list of questions and selected the 14 most relevant. Four or five students ran the meeting including discussions of half the questions in two breakout rooms. Participants provided lists of places they wanted the community to have, reasons why they didn't like dense housing, how to take advantage of the river, as well as ideas for wealth building, economic development, and urban farming.

After this meeting the students had the opportunity to meet in person with young adults who responded to their proposed vision projects for the next phase. At this pin-up session, the students found the feedback specific to their projects that contrasted with the feedback from the community meetings very helpful.



Informal Review of project program and design proposal with Young Adults after Meeting 5.

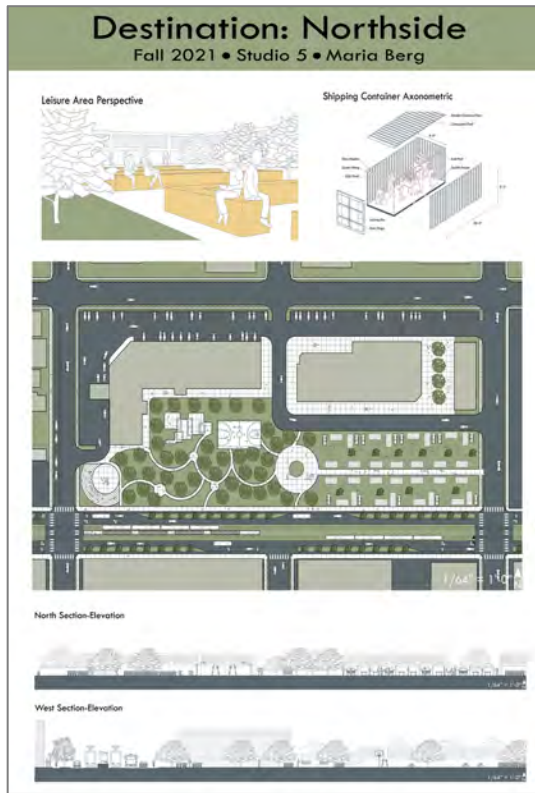

Destination Northside (Light Rail Stop, Performance Amphitheater, & Market) Maria Berg, Arch 5212, Fall 2021

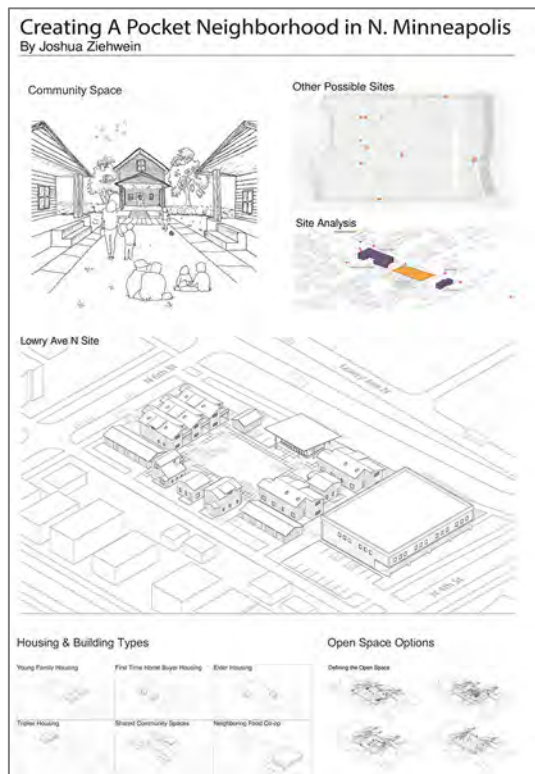

Creating a Pocket Neighborhood in North Minneapolis (Missing Middle Cooperative Housing with Community Courtyard on Land Trust Site), Joshua Ziehwein, Arch 5212, Fall 2021

Meeting #6. Review of Student Vision Designs (to be completed for the January final version)

The sixth meeting focused on the student proposals with four breakout rooms. Within each breakout room, two students presented two to three of the eleven proposals for feedback. Participants responded with such ideas as helpful suggestions about siting in the neighborhood, questions about the efficacy of land trusts, and saying what they didn't understand. While they questioned some of the particular design choices, overall, they supported the project choices. This helped the students frame their final proposals, informing them how to develop their designs and refine their arguments to be more convincing.

Meeting #7. Final Vision Design We had hoped that this meeting could be held in person, but the community members chose to have it on Zoom. The students had presented their work for the final review five days earlier. Although we again planned for four breakout rooms so students work could have detailed attention, the community attendees thought it would be better to have more participants in each room, so we ended up with three. The community members were very enthusiastic about the student work, saying that it needed to be presented to the city planners before they made their designs. They stated that their ideas were well-represented and thanked the students for the thoughtful work.

This spring semester the project is funded to develop an exhibition to show the work in neighborhood settings in late spring and over the summer, as we recruit participants for the next year. Several of the community members are organizing a meeting with the mayor to present the student work. Next year we plan to work with a Northside community garden organizer to bring youth interns to the project and a more active participatory approach to the engagement process.

5.0 WHAT WE LEARNED

Recruitment. Traditional modes of recruitment, for example with a church, may result in an older community group with a shared, more conservative perspective. However, such a group is likely be committed to the project and consistently attend meetings. Adults with children have difficulty attending community meetings. It is difficult to recruit young adults who may have an unpredictable agenda. Young people who are high school are easier to identify and systematically participate than older youth. The students wanted to go out into the community and talk with residents informally, which was also suggested by several design critics. There were two reasons they were discouraged from doing so. First, local research team members asserted that the neighborhood was unsafe due to many shootings. Second, the neighborhood is a subject of many studies, and we did not want to be invasive. For the next phase, we will create a larger group of participants, and better age balance, by beginning recruitment in the spring.

Community Design. It is essential to find out about the existing community activities and organizations. Without knowing these and how they work in the community, it is impossible to be credible in making proposals. As a part of our cooperation with the Gardening Activist, we are receiving a list of local organizations that will allow to to develop contacts for students to talk with about the neighborhood, and for engagement in the design work. We also need longer meeting times, perhaps substituting charettes for some meetings.

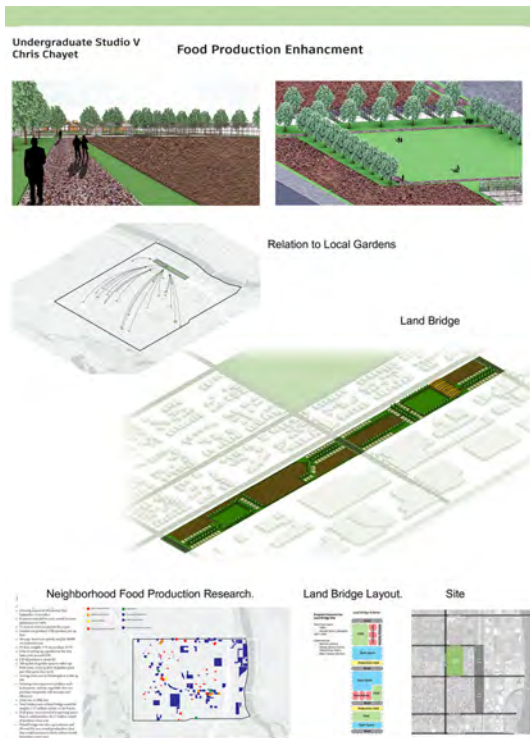

Food Production Enhancement (Land Bridge for Urban Farming & Greenhouses Connecting to Riverside Area), Chris Chayet, Arch 5212, Fall 2021

Contradictory Ideas. Often within a community, group ideas will be expressed that seem to contradict each other. However, as one probes the reasoning behind the two ideas, what at first appears to be contradictory, can be seen as simply two different ways of seeing a situation, and two different approaches to an agreed-upon problem. Then one can explore the nature of the problem and possibly propose a solution different than either of the initial contradictions. With longer meeting times, this may take place exploring ideas with the community members.

Working with young adults. Originally, the idea was to have the interns work side-by-side with the university students. Due to limitations in time spent together, and the students desire to hear young people's ideas about the neighborhood and their response to student projects, having interns and young adults review projects in pin-up sessions and other reviews turned out to be a very productive form of participation. We seek funding for interns, but if that doesn't work out, we will include youth as members of the community engagement group. We found the younger people to be less hesitant to consider new ideas. Having them in the group expands the range of bottom-up thinking.

Community Aspirations. Foremost for community members was having a safe neighborhood. There was interest in affordable housing and wealth-building through home ownership and through business development. Job training and developing entrepreneurship was highly valued. But the most shared aspiration was having urban farming that gives young people activities after school and produces healthy food for the community. For next year, we will use urban farming as a framing program, and will incorporate a bigger emphasis on crime reduction, perhaps making it one of the geodesign layers.



A School Resource Center (Addressing Disparities in Services Provided at Elementary and Middle Schools), Emily Dam, Architecture 5212, Fall 2021

Addressing Disparities in Designs. The eleven projects completed by the students addressed several issues. Several designs addressed ways to connect to the river across the I-94 highway that separates the main neighborhood from the river. Other designs proposed transforming the industrial area along the river to other functions, especially business and housing. Some proposals developed affordable communities of middle housing with shared amenities. Housing for young adults is another theme, as there are a great many youths graduating from foster care, or who are homeless and struggling to find housing. Several projects addressed food production and distribution. Another theme was to provide places for after school activities for youth who need a place to be and to study away from home. All of these responded to resident observations of community needs. Next year, having more interaction of participants with maps and design options should facilitate a more bottom-up approach.

Standard Urban Design Approach. The standard approach to urban design is to construct the environment as a series of parts that can be assembled in a variety of ways. Typically, these are represented as maps, plans, axonometric drawings, or bird's eye perspectives. This way of thinking can be seen as top-down design which doesn't address the actual use and experience of the environment, nor the complexity of the integrated whole. Some people see this approach as a white person's way of urban design, suggesting that different approaches to design be developed that start from a bottom-up understanding more integral with experience than abstracted from reality, and that is more related to the inhabitant. This is a challenge to be taken up in future studios, by developing more interactivity at the beginning of the design process, and by enhancing the experiential side of design in the ways material is manipulated by and presented to participants.

CONCLUSIONS

Leading a design studio that engages with communities is very challenging. It requires considerable lead time to identify community participants and develop appropriate community engagement strategies, whether meetings, charettes or other forms. It may be impossible to find fully representative community participants. A project budget needs to include funds for stipends at a good hourly rate such as \$25/ hour for adults. Ideally, one would also pay for speakers and for reviewers' time. We used consultants to recruit, but ran into difficulties with interns, because we focused on young people 18-26, which turned out to be a difficult demographic.

Time consuming activities include arranging for meetings and reviews and communicating with participants and reviewers with reminders and updates. The schedule may be in a state of flux throughout the entire term. To create some stability, it can be important to develop key dates as markers in the term and maintain these as much as possible.

Perhaps most exciting, and stressful, is the process of working with students. Working with students to communicate schedule changes, perhaps due to speakers' agendas, to develop appropriate review formats, to develop meaningful discussions of readings, requires constant attention.

Students may bring their own ideas about how such a studio ought to be run. It requires special attention to student concerns and insecurities about having insufficient information. As designers we know information is essential to good design. We also know it is rarely possible to have all the information one needs to design. This paradox is very problematic, and students may require assurance that they are on a good path. Listening to communities, while essential, also often results in hearing contradictory messages, as we mentioned earlier, which complicates, rather than simplifying design decisions for students. And as the class progresses, and one learns about students and community members, it is important to be willing to change direction in response to new information.

Teaching a studio that engages community members is not for the faint-of-heart. Each studio experience is unique, and a pioneering effort. It is frustrating if community members, reviewers, speakers, or students are not able to participate as planned, or if they make unhelpful critical remarks. If even one student does not listen to community members, the entire class may be blamed. On the other hand, community members are often stimulated and motivated by the student ideas. If the project is successful, community participants may discover an appreciation for the potential of their community to develop productively. Ideally, both students and community participants will be inspired to commit to making all neighborhoods a better place to live.

REFERENCES

- American Institute of Architects Minnesota, Center for Sustainable Building Research and Colloqate Design. 2018. *Twenty-first Century Development* Website. <https://www.21stcenturydevelopment.org/>
- Bell, R. R., and P. D. Bauknight Jr. "Revamp the Upper Harbor project" *Minneapolis Star Tribune*, June 22
- LISC, Twin Cities & Center for Urban & Regional Affairs. 2014. Moving Beyond the Gap: Racial Disparities in North Minneapolis. northsidefund.org/wp-content/uploads/2014/03/Racial-Disparities-in-North-Mpls.pdf
- Robinson, J. W., and A. Price. 2021. "Expanding Youth Opportunity Studio: Design Research Engaging Community Participants," *Performative Environments: Proceedings of the Architectural Research Centers Consortium (ARCC) 2021 International Conference (Virtual)*, Tucson
- Steinitz, C. 2012. *A Framework for Geodesign: Changing Geography by Design*. Redlands, CA: Esri Press

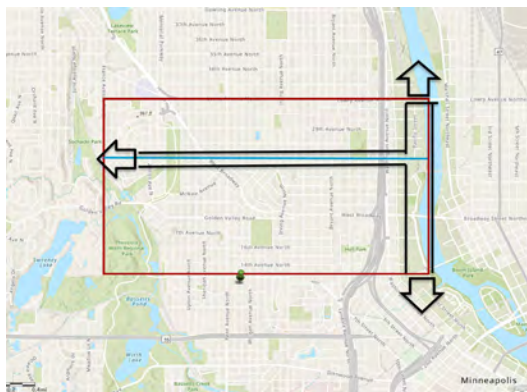

The project site in North Minneapolis showing the Mississippi River to the east of the site, and I-94 highway (in gray), dividing the presently industrial area along the Mississippi River from the predominantly residential area to the west. Arrows indicate the desire to connect the neighborhood to the parkway north and south along the River, and to the Theodore Wirth Park and lakes to the far west and southwest (part of the "Grand Rounds" of the Minneapolis Park system),

Designing For Wellbeing: The Role of Architecture in Addressing Social Equity in Response to COVID-19

Ebtehal Bahnasy¹

¹University of Minnesota, Minneapolis, MN

ABSTRACT: The spread of COVID-19 has dramatically shifted the nature of the relationship between people and their surrounding environment. The way people inhabit a space, interact with its surfaces, and the occupation density is now guided by sets of rules that aim at ensuring people's safety from the virus. Safety measures such as social distancing, working remotely, and self-quarantining are taken in order to slow the spread rate. Consequently, the design of the built environment is being retrofitted in response to the currently evolving situation. However, as people's needs, abilities, and socio-economic circumstances differ, adaptation needs to be equitable and inclusive to all users. A response that doesn't have equity as a central consideration risks the wellbeing of those occupants that are the most vulnerable such as people of color, immigrants, the elderly, and other vulnerable population groups. The methodology acknowledges and addresses the lessons learned from past pandemics and public health issues such as cholera and the Spanish flu. The goal of this research is to ensure a safe, inclusive, and equitable environment in light of the pandemic. It aims to provide designers with a robust set of principles to guide the design process. An investigation of the vulnerable user groups is conducted to identify their necessary needs. These findings are followed by a data classification phase to identify equitable post-pandemic design principles. These indicators lead to the formulation of a design toolkit for an equitable and inclusive response. Furthermore, spatial analysis is used to evaluate the design interventions and to systematically apply the toolkit. Visibility graph analysis, isovists, and justified accessibility graphs are generated to test the toolkit on floor plans and evaluate the design interventions and their impact on the social performance of spaces. The application of this proposal promotes a healthy and safe environment for the different groups of users.

KEYWORDS: Equitable design, post-pandemic architecture, wellness, public health, vulnerable populations, space syntax.

INTRODUCTION

In addition to the historical, socio-cultural and economic factors, the design of the physical world we live in today is also a combination of design principles and laws that were implemented in response to past illnesses and epidemics. These events had an impact on the design of the urban, architectural, and interior environments. Early on in history, were implemented to provide a healthier environment. This resulted in wider streets and better there was a realization that spaces can be purposefully designed to assist in the prevention, containment, and treatment of infectious diseases (Chang 2020) At the end of the Middle Ages, building and urban codes infrastructure (Haley 2020), building materials were regulated by law after the Great Fire of London in 1666 (Woodrow 2020), and the great Chicago fire changed the codes in the United States. In the 20th century, architectural modernism was an emerging movement in response to the Spanish flu and earlier pandemics, such as cholera (Chang 2020). Modernist architects were designing clean, smooth, and ornament-free surfaces in order to limit the spread of infection (Chang 2020).

In Le Corbusier's Villa Savoye, he rejected spaces that normally collect moisture or dust. The villa stands on piloti, with no dank cellar, and the flat roof serves as another living space instead of an attic (Carr 2014). In the letters that the Savoye family were sending to Le Corbusier stating their design preferences, one could sense their focus on hygiene through their request of a sink near the entrance and the requests for running water in various spaces (Savoye and Delhomme 2020). Another prime example of the critical role of architects in public health is displayed in the response to Ebola in 2014, with the renovation of isolation units, the creation of innovative ventilation strategies, and the design of pathogen-resistant surfaces (Murphy 2020).

Since February 2020, the United States of America has recorded over 31.8 million confirmed cases of COVID-19. The whole world is learning more about this novel virus as the days go by, and safety measures such as social distancing, working remotely, and self-quarantining are taken in order to slow the spread rate. The center for Disease control and prevention (CDC) provides a regularly updated set of guidelines and recommendations (*C. f. Prevention 2021*).

All this requires altering the physical surroundings, either to accommodate new functions or to facilitate a safe and healthy environment. It only makes sense to learn from the events that happened in the past and to build on this knowledge. However, in order to be able to reach an equitable and inclusive response, the design process should take a critical approach to identify and acknowledge the different needs of our communities today. The industrial community

of New Lanark is an early example of a project that prioritized wellness and equity. This small 18th-century village set in a sublime Scottish landscape was where the philanthropist and Utopian idealist Robert Owen molded a model industrial community in the early 19th century (UNESCO 2001). Owen prioritized health and cleanliness and the education of children of the workers (Dowd 2020). He aimed to serve the workers and their families and provided them with spacious and well-designed housing. But although this project aimed to help the poor, it was criticized for not empowering them, a powerful figure was still needed to achieve positive social change (García 2016). An equitable design should dismantle systemic inequities fundamentally and challenge them, and that is the main goal for this research.

In Congo, single-patient transparent units emerged during the recent Ebola outbreak to isolate patients, protect health workers and to permit loved ones to visit without risking exposure. Healthcare workers were able to monitor vital signs from outside the units, and the mental wellness of the patients and their visitors was prioritized. Another recent response to Tuberculosis is a new hospital in Haiti. The facility has a garden and open spaces, lots of sunlight and air flow from different directions at all times. These recent responses provide opportunities to learn from public response and priorities in facing diseases.

1.0 IDENTIFYING VULNERABLE POPULATIONS

Data is showing that the pandemic is disproportionately affecting people from marginalized communities (Williams and Blanco 2020). CDC publishes reports that compare rate ratios of COVID cases, hospitalization, and death between different races and ethnicities (*C. f. Prevention* 2021). This disparity can be traced back to several social, economic, financial, and health related conditions. These conditions either facilitate or hinder a community's ability to take these safety measures. Given that the design of spaces, buildings and cities plays a vital role in public health (Luscombe 2020), it should also aim to eliminate disparities and to achieve equity. This can be achieved through the application of inclusive design principles that address the different needs of users. In order to be inclusive to different vulnerable population groups, and to be able to accommodate their different needs, these groups should be first identified. In addition to the general public health regulations that would serve all building users, this section aims to pinpoint critical design elements that serve vulnerable users.

Research shows that the level of risk of contracting the virus is different depending on gender. Cultural and social aspects play an important role in this. For instance, there is a global increase in the number of reports of domestic violence against women as a result of lockdown regulations (Mohan 2020). Women also comprise more than the majority of humanitarian workforce, which puts them in higher risk (Sharma, et al. 2020). With their role as mothers, and in many cases caregivers to vulnerable family members, they need hygienic building utilities that accommodate their needs as well as those of children and accompanying dependents. Examples include lactation rooms, family bathrooms, and socially distant waiting areas.

Additionally, certain communities are exposed to inequitable socio-economic conditions and political factors that causes their vulnerability. This includes people of color, immigrants, and LGBTQ + populations (Kline 2020). Pandemic response teams such as Health Cluster and partners aimed to protect, assist and advocate for refugees, internally displaced people, migrants and host communities for their vulnerability to the pandemic (WHO 2020)¹⁰⁶. The use of inclusive language and clear visual representation of health advisories is critical to serving these groups. While many of them also face discrimination, providing inclusive restrooms, wellness rooms and lactation rooms will increase their chances of a more hygienic experience.

Many resources explored how the physical and mental state of users require different measures. Singh (2020) discussed how the different physical and sensory needs of users should be considered in the design of spaces and of the health advisories. 80% of people with disabilities in the world live below the poverty line and are the most negatively affected by the social and economic impact of the lockdown and social distancing measures (*Reliefweb* 2020). Choi et al. (2020) and Carnevalea and Hatak (2020) focused on the users' mental health and highlighted the importance of addressing this in such unprecedented times. This calls for an inclusive response that accounts for different physical and sensory abilities. This response includes social experiences as well, to minimize feelings of isolation and loneliness. Positive nudging would improve the general morale and decrease stress while following health advisories.

2.0 EQUITABLE RESPONSE TOOLKIT

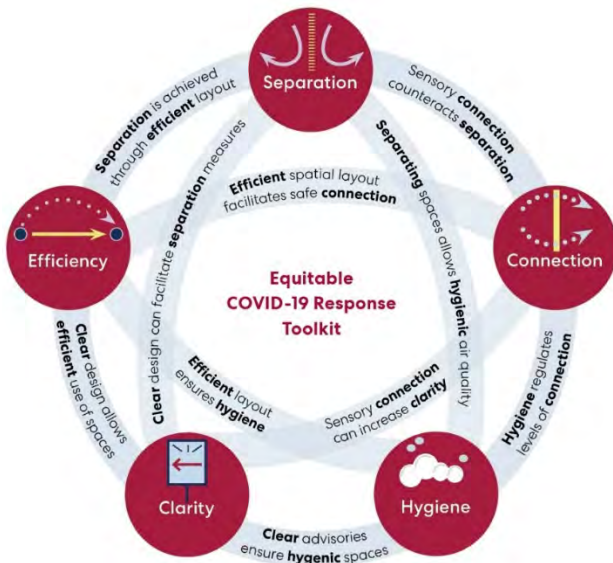

Through a process of synthesizing the data about the vulnerable population groups, lessons from past pandemics, and equitable design elements, a set of design principles was created. Pre-COVID, these design principles were prioritized depending on the project type, budget or other factors. For instance, connected spaces and open floor plans were common in workplaces, and separation was applied for acoustical purposes or to separate different uses. The proposed toolkit prioritizes these principles depending in the user groups instead. Figure 1 illustrates the relationships between the five design principles. The vulnerable population groups share a set of challenges that increase the risk of them getting the virus. The table below lists these challenges and illustrates how the toolkit addresses each of them. Table 1 highlights the direct connections; however, the design principles overlap and correlate, and the challenges apply to more groups and more people at different levels.

Figure 1 Equitable response toolkit. Source: by author.

	Immigrants	The elderly	People with underlying health conditions	LGBTQ+ community	Isolated employees	Frontline workers	Females	People of color
Mental wellness								
Caregiving								
Interpretation of health advisories								
Physical wellness								
Socio-cultural aspects								
Discrimination								
Necessary interaction								

Table 1 Challenges facing vulnerable population groups and toolkit application. Source: by author.

In the following section, the principles will be defined, and examples of actionable items are provided to guide the design process.

2.1. Clarity

Clarity in building layout and health advisories can ensure a safer experience.

Examples of actionable items:

- Provide simple health advisories.
- Strategically locate stairs and elevators.
- Design clear entrances and exists.
- Ensure clarity of space layout and intuitive.

2.2. Efficiency

Efficiency and functionality should be prioritized above other commercial or entertainment purposes.

Examples of actionable items:

- **Design short one-way circulation paths.**
- **Minimize or avoiding unnecessary decorative elements.**
- **Take inspiration from principles of modernism and minimalism.**
- **Design purposeful spaces and surfaces.**

2.3. Separation

Separation aims at decreasing unnecessary interaction with people or with surfaces.

Examples of actionable items:

- Separate furniture in seating areas.
- Limit capacities of meeting areas and open floor plans.
- Include gender neutral and family bathrooms.
- Install a greater number of smaller elevators, rather than large ones.

2.4. Connection

Visual and sensory connection contribute to the mental wellness of users and to motivate them to follow the safety advisories.

Examples of actionable items:

- **Increase opportunities for visual and auditory connection.**
- **Promote social relationships using open public spaces on site.**
- **Allow virtual connection systems when possible.**

2.5. Hygiene

Material selection and mindful design interventions can facilitate cleanliness and contribute to a hygienic experience.

Examples of actionable items:

- Include sanitizing stations near entrances.
- Choose easy to clean materials.
- Avoid the design of spaces and corners that are hard to maintain and clean.
- Control temperature and humidity level.
- Allow natural ventilation.

3.0 SPATIAL ANALYSIS

Space Syntax theory provides a comprehensive and consistent framework for understanding spatial arrangements and their likely human effects, which we can term as social performance of buildings (Nourian, Rezvani and Sariyildiz n.d.). This method can be used to reveal the relationship between spaces and the social properties that necessitate or sustain these relations (Lee, Ostwald and Lee 2017). Figures 2 and 3 illustrate the basic representation methods used in space syntax.

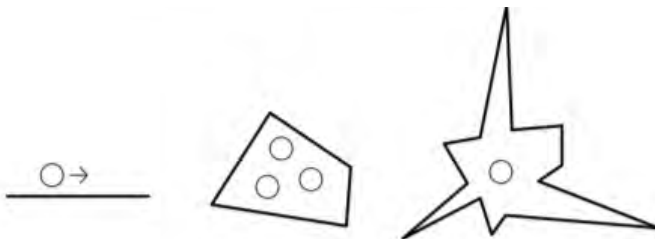

Figure 2 (left) a representation of the way people move, mostly along a line; (middle) convex space where users see each other and in which interactions take place; (right) the visibility field (Isovist), which has a different shape depending on where the observer is located (DETLAFF n.d.).

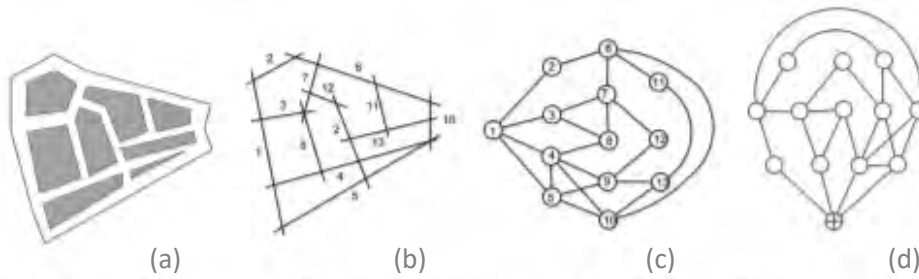

Figure 3 (a) fictive urban system; (b) axial map; (c) connectivity graph; (d) justified graph (DETLAFF n.d.).

3.1 Isovists

Isovists (figure 4) are a series of diagrams demonstrating the field of vision from different standpoints. The clarity of circulation paths, stairs, and elevators can be evaluated.

Toolkit application example: In a public building, visitors should be able to see the department/ spaces they need to go to directly without unnecessarily passing through more spaces.

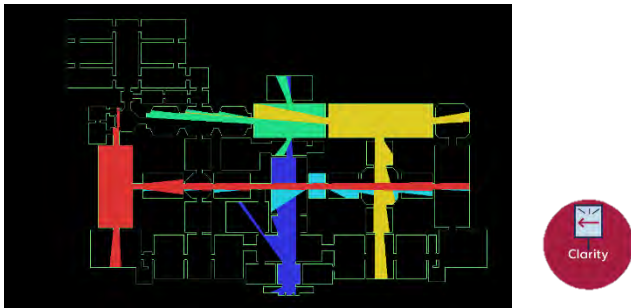

Figure 4 Isovists from different standpoints. By author, software: DepthmapX

3.2 Justified accessibility graphs:

The circles in the diagram (nodes) represent spaces (figure 5). Red nodes are spaces that connect to many others. The efficiency of layout and circulation can be evaluated.

Toolkit application example: Red nodes are spaces that have high traffic. Such spaces should not include seating or waiting areas.

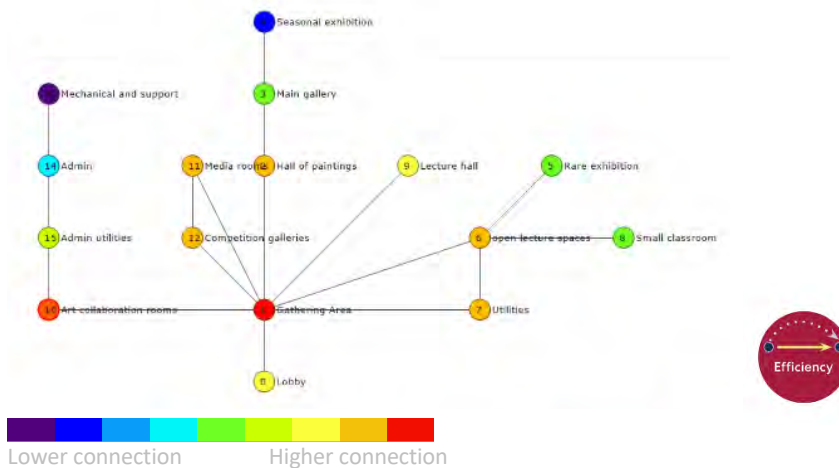

Figure 5 Justified accessibility graphs. By author, software: Agraph.

3.3 Visibility graph analysis (VGA):

The VGA process (figure 6) maps various values (color coded from red for “very high” measures to dark blue for “very low” measures for representation) to each grid square. This figure shows that the four wings in have low connectivity values (dark blue), thereby becoming visually and socially isolated in the plan (Lee, Ostwald and Lee 2017). This figure shows which areas of the floor plan are isolated and which ones are highly connected. Blue and red spaces indicate separation and connection respectively. Highly connected spaces should have high hygiene considerations such as sanitation stations.

Toolkit application example: Mental health should be prioritized for employees in isolated area.

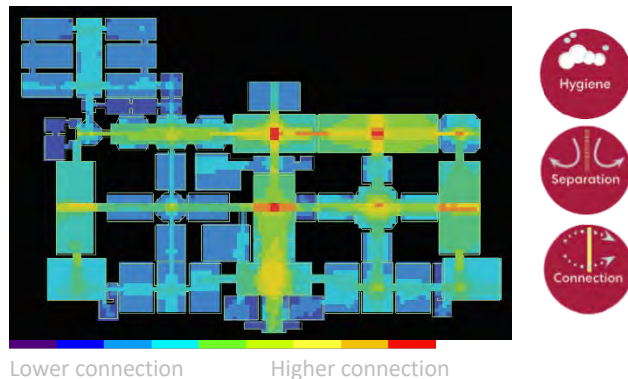

Figure 6 VGA. By author, software: DepthmapX

CONCLUSION

The United Nations Network on Migration has issued a statement emphasizing that “COVID-19 does not discriminate, nor should our response” (*The department of global communications 2020*). Singapore was one of the countries that had to face the inequality within its society in order to contain the virus. The country’s second outbreak was centered in overcrowded areas inhabited by migrant workers, bringing the attention to the awful living conditions they endured (Bremmer 2020). At one point, 88 percent of the country’s cases were in these areas (Bremmer 2020). As a result, Singapore had to reintroduce stay-at-home orders and to close schools, making it the only country which experienced heavier social distancing and quarantine measures later into their Covid-19 journey (Soistmann 2020). Other pandemic diseases such as tuberculosis, HIV infection, and cholera are still in alarmingly high rates among some vulnerable populations who were marginalized in measures of diagnostics, pharmaceutical interventions, and public health solutions (Ivers and Walton 2020).

Through exploration of equitable design response, lessons from past pandemics, and the challenges facing vulnerable population groups, the toolkit was generated. It is composed from design interventions under the principles of separation, connection, clarity, efficiency and hygiene. The principles address the challenges and aim to create space that promote wellness to different groups of users. The design interventions are analyzed and evaluated through space syntax analysis. Isovists, VGA, and justified accessibility graphs are used to visually represent the toolkit and to test the impact of the design interventions. This research can have a positive impact on the design of healthcare facilities, workplaces, educational institutions, and different public facilities.

Future exploration of space syntax can help support and develop the toolkit. Currently, the spatial analysis is conducted in floor plans. Analyzing and studying building sections can provide deeper insight on the impact of the design interventions. Additionally, specialized facilities may require a focus on a specific population group, such as the elderly and caregivers in a care facility. An analysis of that specific typology is required to focus on the needs of these user groups. Finally, as our knowledge about the virus and its variants is increasing, the response should be altered and edited accordingly.

ACKNOWLEDGEMENTS

This research was carried out during a research internship at Perkins&Will Minneapolis. I would like to thank Jennifer Christiaansen, Doug Bergert and Pratibha Chauhan for their contribution to this research and continuous guidance. Additionally, I gratefully thank my academic advisor Richard Graves and the director of the Master of Science in Research Practices program Malini Srivastava for their support and assistance throughout the duration of this project.

REFERENCES

- Bremmer, Ian. 2020. *The Best Global Responses to COVID-19 Pandemic*. June 12. Accessed July 14, 2020. <https://time.com/5851633/best-global-responses-covid-19/>.
- Carnevalea, Joel B., and Isabella Hatak. 2020. "Employee adjustment and well-being in the era of COVID-19: Implications for human resource management." *Journal of business research*.
- Carr, Sara Jensen. 2014. *The Topography of Wellness: Mechanisms, Metrics, and Models of Health in the Urban Landscape*. Dissertation, Berkeley: University of California,.
- Chang, Vanessa. 2020. *The Post-Pandemic Style*. April 19. Accessed July 9, 2020. <https://slate.com/business/2020/04/coronavirus-architecture-1918-flu-cholera-modernism.html>.
- Choi, Kristen R. , MarySue V. Heilemann, Alex Fauer, and Meredith Mead. 2020. "A Second Pandemic: Mental Health Spillover From the Novel Coronavirus (COVID-19)." *Journal of the American Psychiatric Nurses Association*.
- Dettlaff, Weronika. n.d. "Space syntax analysis – methodology of understanding the space." *PhD Interdisciplinary Journal* 283- 230.
- Dowd, Douglas F. 2020. *Robert Owen British social reformer*. May 10. Accessed July 10, 2020. <https://www.britannica.com/biography/Robert-Owen#ref221944>.
- Esri, Johns Hopkins. 2020. *Virus spread data*. July 8. <https://finance-commerce.com/minnesota-covid-19-resources/>.
- García, Mario Cuenda. 2016. *Why Owenite communities were destined to fail*. 3 31. Accessed 8 4, 2020. <https://mariocuendagarcia.wordpress.com/2016/03/31/why-owenite-communities-were-destined-to-fail/>.
- Haley, Kathleen. 2020. *Rethinking Our Built and Open Spaces After a Pandemic*. June 12. Accessed July 9, 2020. <https://news.syr.edu/blog/2020/06/12/rethinking-our-built-and-open-spaces-after-a-pandemic/>.
- Ivers, Louise C., and David A. Walton. 2020. "COVID-19: Global Health Equity in Pandemic Response." *The American Society of Tropical Medicine and Hygiene* 1149–1150.
- Kline, Nolan S. 2020. "Rethinking COVID-19 Vulnerability: A Call for LGBTQ + Im/migrant Health Equity in the United States During and After a Pandemic." *Health Equity*.
- Lee, Ju Hyun, J Michael Ostwald, and Hyunsoo Lee. 2017. "Measuring the spatial and social characteristics of the architectural plans of aged care facilities." *Frontiers of Architectural Research* 431–441.
- Luscombe, Belinda. 2020. *Architect Rem Koolhaas Says Redesigning Public Spaces Was Necessary Before the Pandemic*. May 14. <https://time.com/5836599/rem-koolhaas-architecture-coronavirus/>.
- Mohan, Megha. 2020. *Coronavirus: Domestic violence increases globally during lockdown*. 6 12. Accessed 8 4, 2020. <https://www.bbc.com/news/av/world-53014211/coronavirus-domestic-violence-increases-globally-during-lockdown>.
- Murphy, Michael. 2020. *The role of architecture in fighting a pandemic*. April 6. Accessed July 10, 2020. The role of architecture in fighting a pandemic.
- Nourian, Pirouz, Samaneh Rezvani, and Sevil Sariyildiz. n.d. "Designing with Space Syntax: A configurative approach to architectural layout, proposing a computational methodology." *Spatial Performance and Space Syntax* 357- 366.
- Prevention, Centers for Disease control and. 2021. *Hospitalization and Death by Race/Ethnicity*. April 16. Accessed April 20, 2021. <https://www.cdc.gov/coronavirus/2019-ncov/covid-data/investigations-discovery/hospitalization-death-by-race-ethnicity.html>.
- Prevention , Centers for Disease Control and. 2021. *Protect Yourself*. March 8. Accessed April 20, 2021. <https://www.cdc.gov/coronavirus/2019-ncov/prevent-getting-sick/prevention.html>.
- Reliefweb. 2020. *United Nations includes vulnerable people in revised COVID-19 response plan*. May 15. Accessed July 14, 2020. <https://reliefweb.int/report/world/united-nations-includes-vulnerable-people-revised-covid-19-response-plan>.

Savoye, Jean-Marc, and Jean-Philippe Delhomme. 2020. *The sunny days of Villa Savoye*. Birkhauser.

Sharma, Vandana, Jennifer Scott, Jocelyn Kelly, and Michael J. VanRooyen. 2020. "Prioritizing vulnerable populations and women on the frontlines: COVID-19 in humanitarian contexts." *International Journal for Equity in Health* 19-66.

Singh, Satendra. 2020. "Disability ethics in the coronavirus crisis." *Journal of Family Medicine and Primary Care*.

Soistmann, Rebecca. 2020. *How 9 countries responded to Covid-19—and what we can learn to prepare for the second wave*. May 8. Accessed July 14, 2020. <https://www.advisory.com/research/global-forum-for-health-care-innovators/the-forum/2020/05/covid-19-covid-19-responses>.

UNESCO, world heritage center. 2001. *New Lanark*. Accessed July 10, 2020. <https://whc.unesco.org/en/list/429/>.

WHO. 2020. *COVID-19 response*. May. Accessed July 14, 2020. <https://www.who.int/health-cluster/news-and-events/news/COVID19/en/>.

Williams, Aaron, and Aadrian Blanco. 2020. *How the coronavirus exposed health disparities in communities of color*. July 8. <https://www.washingtonpost.com/graphics/2020/investigations/coronavirus-race-data-map/>.

Woodrow, Ingrid. 2020. *Living Architecture, Key to Post-Pandemic Cities*. May 3. Accessed July 9, 2020. <https://theurbandevolver.com/articles/green-space-architecture-after-coronavirus>.

Trends and Correlates of Neighborhood Park Access in Philadelphia

Tiara Halstead¹, Russell McIntire¹

¹Jefferson College of Population Health, Thomas Jefferson University, Philadelphia, PA

ABSTRACT: Background: Studies have shown that exposure to green spaces can positively impact mental and physical health, but access is not distributed equally. Our study aimed to identify the trends and correlates of park access in Philadelphia to highlight demographic groups with less access and provide insight into which health outcomes are associated with park access in Philadelphia. Methods: Our study was a secondary analysis of the Public Health Management Corporation's Household Health Survey, using both descriptive and analytic methods. We used the 2012, 2015 and 2018 datasets to describe the proportion of adults reporting access to a neighborhood park by Philadelphia planning district. Using the 2018 dataset only, we ran a binary logistic regression model to identify the correlates of park access among adults in Philadelphia. Results: Our geographic analysis showed that access to neighborhood parks is not equal among Philadelphia planning districts. We found a consistently high percentage of respondents reporting access to parks in the Central, and consistently low access in Upper North, North, and Lower Southwest planning districts. The analytic study showed that women, older age groups, minorities, and those with lower education levels had less access to parks, after controlling for potential confounders. People living in neighborhoods with low social capital reported less access than those living in neighborhoods with medium or high social capital. People with asthma or hypertension had less access than people without these conditions. Conclusions: Park access is not equitable across all demographic groups and planning districts in Philadelphia. Additionally, people with asthma or hypertension had lower odds of reporting access than people without these conditions, suggesting that parks access may be a protective factor for chronic disease development. The results of this study can be used to advocate for increasing access to parks and green spaces, especially among underserved groups in Philadelphia.

KEYWORDS: Public Health and Public Space, Park Access, Equity, Asthma, Hypertension, Philadelphia

INTRODUCTION

1.0 BACKGROUND

1.1 Parks and Urban Environments

A robust literature has identified the mental and physical health promoting effects of green space (Frumkin et al. 2017). The benefits to health associated with access to green spaces are especially evident in urban environments (Sefcik et al. 2019), which are typically highly developed with less land dedicated to green spaces, such as parks, when compared to non-urban environments. Philadelphia is home to over 300 parks and outdoor recreation facilities (City of Philadelphia 2020). Philadelphia's government expressed support for increasing the number of green spaces in 2008 to benefit city residents' mental and physical health (Pearsall & Eller 2020). Improving the availability and quality of outdoor spaces for marginalized communities could help address health disparities (Beyer et al. 2014), by providing common spaces for people to socialize, exercise, and experience the health promoting effects of exposure to nature. In fact, studies have shown that outdoor green spaces have had a greater impact on those with low incomes, the elderly, and are socially isolated (Beyer et al. 2014). Despite public and private efforts, Philadelphia lacks equitable access to safe parks, which has potential negative impacts on those underserved populations' mental and physical health (Pearsall & Eller 2020).

1.2 Mental Health

Physical neighborhood conditions can impact the mental health of a community. Characteristics like vacant spaces, trash, and poor infrastructure are associated with depression (South et al. 2018). The quality of a person's environment has the power to impact how they feel about themselves and their lives. Public outdoor spaces can facilitate feelings of social support because they create a place to interact with the community (Beyer et al. 2014). Spending time in outdoor spaces can also help people manage feelings of stress. However, people living in neighborhoods with low-quality outdoor spaces may feel more stress instead of less stress when spending time outside (Beyer et al. 2014).

1.3. Physical Activity

Public outdoor spaces like parks can promote physical activity and leisurely outdoor activities (Beyer et al. 2014; Park et al., 2018). Research has revealed positive associations between physical activity and perceived distance to the respondents' closest park (Schipperijn et al. 2017), identifying that each park within 1 km of a person's home added an additional 1.8 minutes of exercise per week (Schipperijn et al. 2017). Access to green spaces promotes physical activity, which can protect against chronic diseases such as obesity, hypertension, diabetes, and cardiovascular conditions (Centers for Disease Control and Prevention 2020).

1.4. Barriers to Park Access

Although access to parks has health benefits, many people in urban areas face barriers to utilizing the parks in their neighborhoods. Qualitative and quantitative research has identified that safety is a main concern for park patrons. In areas with high crime levels, people may feel discouraged from using parks and outdoor spaces in their communities, especially at night (Park et al. 2018; Sefcik et al. 2019). People may not use local parks because of concerns about traffic, low lighting, poor maintenance, and lack of supervision (Sefcik et al. 2019). Also, people may have lifestyle and economic barriers to using parks. People in low-income communities may not have leisure time for using a park because of societal, cultural, or economic constraints (Park et al. 2018). Disparities in park access also exist by geography. Studies have found within-city differences in park size attributed to income (Engelberg et al. 2016; Cohen and Leuschner 2019). In one national study, researchers found that higher socioeconomic status (SES) neighborhoods had larger parks, and lower-SES neighborhoods had smaller parks within the same city—even when they had the same resources (Cohen and Leuschner 2019). A benefit of parks is that they are free to access, which makes them an ideal place for physical activity in low-income communities with less access to other physical activity resources, such as private exercise facilities (Park et al. 2018). However, the public nature of parks does not make them equally accessible, as accessibility might be determined by a range of characteristics including acreage, population density, facilities, maintenance and perceptions of safety.

1.5. Parks in Philadelphia

A study on Philadelphia parks identified that lack of park funding caused some residents to be apprehensive about spending time in parks because of their low quality and poor maintenance (Pearsall and Eller 2020). Philadelphia residents have reported not using local parks because of poor conditions, including trash and the presence of drug paraphernalia (Sefcik et al. 2019). One cluster randomized trial study in Philadelphia investigated the effect of vacant lot interventions on health. In this study, clusters of adults within the vicinity of 110 vacant lots were surveyed in response to the random assignment of lots to three treatment groups: no treatment, trash cleanup, or a “greening” intervention which transformed the lot into a park-like space (South et al., 2018). The authors found that exposure to improved green lots improved their feelings of depression (South et al. 2018).

2.0 RESEARCH OBJECTIVE

2.1. Significance

Studies investigating park inequities in the US have, in general, found that areas with low SES and high proportion of minority residents have lower access to parks. One qualitative study sought to address the reason for disparities in park access and quality by comparing different cities from different US regions (Engelberg et al. 2016). The authors found that park quality predictors depend on the city, as each city has different dynamics surrounding issues such as race, socioeconomic status, public policy, and funding (Engelberg et al. 2016). There is also evidence that parks are underutilized even in areas where the infrastructure exists. Park et al. (2018) found this relationship in Los Angeles, where high-poverty neighborhoods saw less park usage compared to low-poverty neighborhoods. This relationship is important in Philadelphia, as there are many parks in the city, but also high poverty rates among the population. The existing literature has identified disparities in park access both nationwide and in Philadelphia. While qualitative studies have investigated the public health implications of park access in Philadelphia (Pearsall and Eller 2020; Sefcik et al. 2019), no previous studies have assessed predictors of access based on a population representative, self-reported survey.

2.2. Research Objective

The objective of this study was to provide further insight into the dynamics of park access in Philadelphia by 1) describing changes in self-reported park access over time (2012-2018) by planning district, and 2) identifying the correlates of self-reported park access in Philadelphia from 2018.

3.0 METHODS

This study used responses to the Public Health Management Corporation 2012, 2015, and 2018 Household Health Surveys, focusing on a particular question about respondents' self-reported access to parks. Maps were constructed using ArcGIS Online to show the geographic distribution of adult responses to the park access question, by Philadelphia planning district. Demographics, risk factors and health outcomes were used to identify correlates of park access among adults in Philadelphia.

3.1. Data

This study used secondary data from the Southeastern Pennsylvania 2012, 2015, and 2018 Household Health Surveys. The Household Health Survey (HHS) is part of the Community Health Database, maintained by the Public Health Management Corporation (PHMC) in Philadelphia. The Community Health Database contains health, social, and demographic information of people living in Pennsylvania. PHMC has collected community health data in Southeastern Pennsylvania via the HHS every two to three years since 1983 (PHMC 2018). The survey data is used to identify public health issues and inform policy in Southeastern Pennsylvania (PHMC 2018). The data covers various health topics, including health behaviors, healthcare access, and chronic diseases. The 2018 HHS was conducted from August 2018 to January 2019 and included Bucks, Chester, Delaware, Montgomery, and Philadelphia counties, reaching 7,501 households. The survey was conducted by telephone and administered in English and Spanish (PHMC 2018).

3.2. Sample and Items

The neighborhood park access item from 2012, 2015, and 2018 is the following: “Is there a park or other outdoor space in your neighborhood that you’re comfortable visiting during the day?” In 2012 and 2015, the responses were simply “Yes” or “No,” however, in 2018 there were three response options: “Yes, there is a park or outdoor space in your neighborhood that you are comfortable visiting;” “No, there is no park in your neighborhood;” or “No, there is a park in your neighborhood but you are not comfortable visiting it.” We dichotomized this variable into “Yes” or “No” categories. Additionally, in 2018, only half of the households surveyed received Form A, which contained the item on neighborhood park access. The sample for the analytic study included adult respondents to the 2018 HHS who answered the park access question, a total of 1,381 respondents.

The demographics chosen for the analysis were the following: gender, age, race/ethnicity, poverty, marriage status, rent/own home, number of children in the household, and education. Risk factors included in the analysis were the following: smoking status, smoking in the home, obesity, exercise, fruit and vegetable intake, regular source of healthcare, and neighborhood social capital. Health outcomes included the following: health status, diagnosed mental health condition, asthma, cancer, binge drinking, high blood pressure (HBP), health insurance, hepatitis C, and diabetes.

4.0 ANALYSIS

4.1. Descriptive Mapping Methods

ArcGIS Online (ESRI n.d.), an online Geographic Information Systems platform, was used to create maps showing the percentage of respondents to the HHS survey who reported park access by planning district, a geographic unit that represents neighborhoods in Philadelphia. Shapefiles for Philadelphia planning district boundaries were downloaded from OpenDataPhilly (OpenDataPhilly n.d.). We downloaded and joined data from the 2012, 2015, and 2018 PHMC HHS to show how self-reported park access has changed over time by planning district in Philadelphia.

4.2. Analytic Methods

The statistical analysis was conducted using IBM Statistical Package for the Social Sciences (SPSS) V. 26 (IBM Corp 2019). Bivariate chi-square analyses of the relationships between each independent variable and the dependent variable were used to identify which variables to include in the final model. Independent variables that were shown to be statistically associated with the dependent variable at a p-value of less than 0.1 were included in the binary logistic regression model. A binary logistic regression model was used to assess the associations between the independent variables and park access.

5.0 RESULTS

5.1. Descriptive Mapping, HHS 2012-2018

The maps identified temporal trends in the percentage of adults reporting access to a neighborhood park access by planning district in Philadelphia (Figures 1-3). The percentage is the proportion of respondents who reported access to a park in each planning district. Overall, the Central district had the highest percentage of reported park access in the city for all three years. Other planning districts that sustained a high percentage of reported access over time included Lower Northwest, Upper Northwest, and Lower South. Residents in the Central Northeast, North Delaware, and Lower Northeast planning districts reported decreased access over time. Areas that sustained a generally low percentage of reported park access over time included the Upper North, North, and Lower Southwest planning districts. Reported access increased in the Lower South, South, University Southwest, West Park, North, and Lower North planning districts between 2015 and 2018. The percentage of reported access changed from 2012 to 2015 and from 2015 to 2018 in many planning districts with no apparent longitudinal trend.

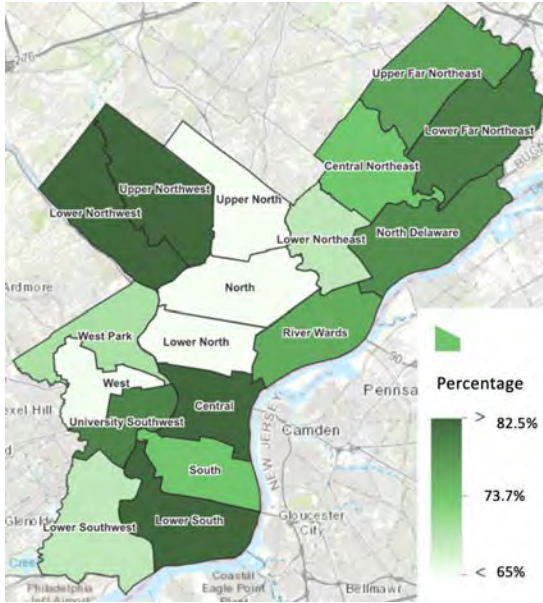

Figure 1. Reported park access percentage by Philadelphia planning district, Public Health Management Corporation 2012

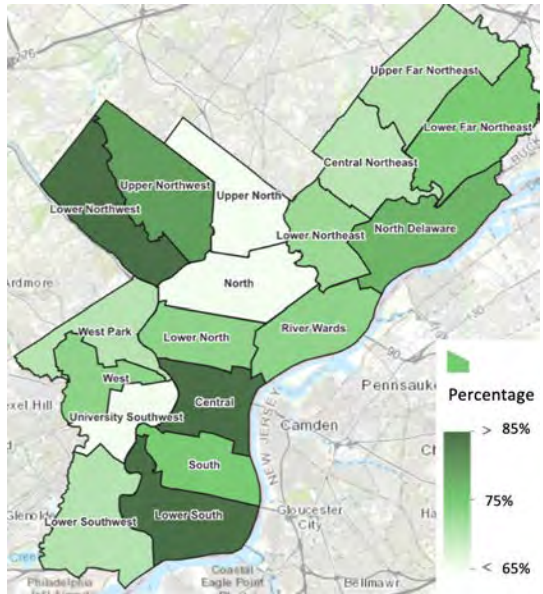

Figure 2. Reported park access percentage by Philadelphia planning district, Public Health Management Corporation 2015

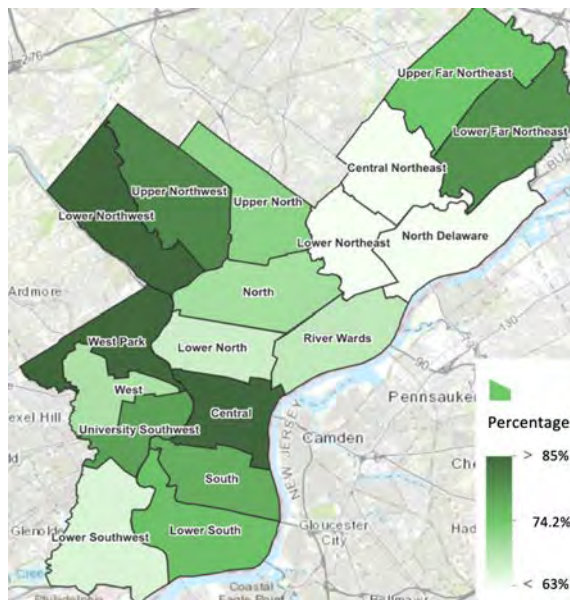

Figure 3. Reported park access percentage by Philadelphia planning district, Public Health Management Corporation 2018

5.2. Analytic Sample, HHS 2018

In 2018, 74.6% of the sample reported having access to a park or outdoor space, while 25.4% of the sample reported not having access to a park or outdoor space. The sample was 45.7% male and 54.3% female. The racial breakdown of the sample was 38.9% White (Not Latino), 36.8% Black (Not Latino), 12.4% Latino, and 10.8% other (which includes multiracial, Asian, and unidentified race). Of the sample, 38.5% attained an education of college graduate or higher, and 61.2% of the sample's highest attained education level was less than college graduate.

Bivariate chi-square analyses were conducted between the dependent variable (park access) and each independent variable separately (gender, age, health status, education, social capital, race, smoking status, number of children in the household, mental health condition diagnosis, asthma, cancer, regular source of healthcare, rent, binge drinking, HBP, health insurance, hepatitis C, diabetes, marriage status, smoking in the home, poverty, obesity, exercise, and fruit and vegetable intake) to reveal potential relationships (Data not shown). Variables with p-values of less than 0.1 were chosen for inclusion in the final model. Independent variables showing an association with having access to a park included: gender ($p < .001$), age ($p < .001$), health status ($p < .001$), education ($p < .001$), race ($p < .001$), mental health condition diagnosis ($p = .001$), asthma ($p < .001$), HBP diagnosis ($p < .001$), hepatitis C diagnosis ($p = .003$), diabetes ($p = .052$), poverty ($p < .001$), social capital ($p < .001$), obesity ($p = .025$), marriage status ($p = .025$), exercise per week ($p = .008$), and fruits and vegetables per week ($p < .001$).

5.3. Binary Logistic Regression Model

A binary logistic regression model was performed using the variables from the bivariate analyses that showed an association with park access at $p < 0.1$ (Table 1). Although there were many variables that made it into the logistic regression model, we are only reporting the statistically significant associations with park access. The measures of effect below were calculated after controlling for each of the variables included in the model simultaneously. We identified the following variables to be associated with self-reported park access: gender, age, race, education, social capital, asthma, and HBP.

Gender: Women had 46% lower odds of having access to a park compared to men (Adjusted Odds Ratio (AOR) = 0.54, 95% C.I. 0.46, 0.88).

Age: Compared to the 18–34-year-old age group, people aged 35–49 had 49% lower odds of having access to a park (AOR=0.51, 95% C.I. 0.32, 0.82). People aged 50–64 had 51% lower odds of having access to a park compared to people aged 18–34 (AOR=0.49, 95% C.I. 0.32, 0.77). People aged 65+ had 77% lower odds of having access to a park compared to people aged 19–34 (AOR=0.23, 95% C.I. 0.13, 0.40).

Race: Latinx people had 61% lower odds of having access to a park compared to White, non Latinx people (AOR=0.39, 95% C.I. 0.23, 0.66). People of “other” race had 73% lower odds of having access to a park compared to White, non Latinx people (AOR=0.27, 95% C.I. 0.15, 0.46). “Other” includes Asian, multiracial, and biracial individuals.

Education: Overall, those with a post-graduate education had the highest access to parks. Those whose highest education was college graduate, some college, high school graduate, and less than high school had lower odds of reporting having access to a park compared to those who had a post-graduate education. People whose highest level of education was college graduate (AOR=0.45, 95% C.I. 0.24, 0.84) had 55% lower odds, some college (AOR=0.50, 95% C.I. 0.27, 0.92) had 50% lower odds, high school graduate (AOR=0.33, 95% C.I. 0.19, 0.60) had 67% lower odds, and less than high school (AOR= 0.37, 95% C.I. 0.17, 0.79) had 63% lower odds of having access to a park compared to people whose highest level of education was post-graduate.

Social Capital: Adults who reported living in neighborhoods with low social capital had 78% lower odds of having access to a park compared to those who lived in neighborhoods with medium or high social capital (AOR=0.22, 95% C.I. 0.16, 0.32).

Asthma: Adults who reported ever being diagnosed with asthma had lower odds of reporting access to a park compared to those who were not diagnosed with asthma (AOR=0.66, 95% C.I. 0.45, 0.96)

Social Capital: Adults who reported ever being diagnosed with HBP had lower odds of reporting access to a park compared to those who were not diagnosed with HBP (AOR=0.51, 95% C.I. 0.35 , 0.74)

Table 1. Binary logistic regression model for predicting access to a neighborhood park in Philadelphia, Public Health Management Corporation Household Health Survey 2018.

	AOR ¹	95% C.I. ² for AOR	
		Lower	Upper
Gender (Ref: Male)	0.64**	0.46	0.88
Age (Ref: 18-34)			
35-49	0.51**	0.32	0.82
50-64	0.49**	0.32	0.77
65+	0.23***	0.13	0.40
Race (Ref: White, not Latinx)			
Black (Not Latinx)	0.69	0.47	1.01
Latinx	0.39***	0.23	0.66
Other	0.27***	0.15	0.46
Education (Ref: Post-graduate)			
College graduate	0.45**	0.24	0.84
Some college	0.50*	0.27	0.92
High school graduate	0.33***	0.19	0.60
Less than high school	0.37**	0.17	0.79
Social capital (Ref: Medium or high)	0.22***	0.16	0.32
Asthma (Ref: No)	0.66*	0.45	0.96
High blood pressure (Ref: No)	0.51***	0.35	0.74

Variables included in the model but did not show an association with park access included: mental health condition diagnosis, hepatitis C, diabetes, poverty, obesity, daily fruit and vegetable intake, and weekly exercise.

*p < 0.05; **p < 0.01; ***p < 0.001

¹ Adjusted Odds Ratio

² Confidence Interval

6.0 DISCUSSION

This study used data from the PHMC HHS to identify temporal trends and correlates of self-reported access to parks in Philadelphia. The results show that park access was not equitable across all sociodemographic groups in Philadelphia, with some groups having lower odds of access to a park. Women had lower odds of access to a park than men. This difference may be attributed to the social climate in which women feel less safe in urban areas, especially if they are alone. Women who use urban parks in Philadelphia may not use them after dark out of fear, especially if the park has little to no surveillance and is in a neighborhood they perceive as less safe (Sefcik et al., 2019). Age was also a factor associated with access. Compared to the 18-34-year-old age group, the 35-49, 50-64, and 65+ age groups all reported lower odds of having access to a park or outdoor space, with those aged 65+ reporting the lowest odds overall. More research could provide insight into why people in the 35-49 and 50-64 age groups

reported lower odds of access compared to 18-34-year-olds. The relationship seen among 65+ year-olds may be because people who are elderly may not feel safe using outdoor spaces alone, or also may not be able to physically access the parks, due to disability or characteristics of the built environment, such as lack of sidewalks or traffic.

Recent analyses have shown Philadelphia to be a heavily segregated city by race (Shukla and Bond 2021). Our results show that this segregation is also reflected in racial and ethnic disparities in park access. We found that Latinx, and those in the “Other” category, including Asian, multiracial, and biracial individuals have less access to a park, compared to White people. While the GIS maps from this study do not show race by planning district, those planning districts with low access to parks are also composed of a high proportion of minorities.

Education levels also were associated with park inequity in Philadelphia. Respondents whose highest level of education was college graduate, some college, high school graduate, and less than high school reported less access to parks than people whose highest education level was post-graduate. In Philadelphia, similar to other major cities in the US, there is much inequity in the distribution of resources. We expected that people with the highest education would live in wealthier neighborhoods with more resources. Additionally, this aligns with our finding that people with low neighborhood social capital reported lower odds of having park access compared to people with medium or high neighborhood social capital. The SES factors in the analysis suggest that having access to individual or neighborhood resources increases the likelihood of self-reporting access to a park in Philadelphia.

HBP diagnosis was correlated with lack of park access among adults in Philadelphia. Studies have identified associations between HBP and low access to greenspace among low income people (Grazuleviciene et al. 2020), and in aggregate by census tract (Knobel et al. 2021) but studies have not always shown significance (Morita et al. 2011). In general, healthy blood pressure among those with access to parks could be attributed to increased physical activity due to park patronization, however, our model controlled for physical activity. It is likely that accessing neighborhood parks lowers stress and relaxes residents who use parks as a form of leisure activity, as studies have shown these relationships among adults (Razani et al. 2018).

Similarly, asthma diagnosis was associated with lack of park access. Studies have identified inconsistent relationships between asthma and urban vegetation, but the majority of studies focus on asthma development in children or acute asthma events among adults, and not adult asthma diagnoses. A study in New York City found that tree canopy cover was positively associated with asthma and allergic sensitization due to pollen exposure (Lovasi et al. 2013). However, other studies show that the air purifying effects of living proximal to parks were beneficial to prevent acute asthma events. A study based in Los Angeles assessed the relationship between asthma emergency department visits, air pollution from diesel particulate matter, and parks and public outdoor spaces. Their findings suggest that increasing the amount of available parks and outdoor spaces while decreasing air pollution could help improve asthma outcomes for low-income communities in Los Angeles (Douglas, Archer, and Alexander 2019).

The utilization of GIS mapping highlighted geographic disparities in reported access and how these disparities changed over time. A notable decrease in park access over time was present in the Central Northeast, Lower Northeast, and North Delaware planning districts. It is unlikely that the number of parks in these planning districts changed, so the change in perception of access is likely socially constructed. The current opioid crisis may have impacted perceptions of public safety in 2018 in these planning districts, contributing to the change. Also, crime rates may have contributed to a feeling of decreased safety. In addition to the large number of parks in Central Philadelphia, it is likely that this planning district had the highest proportion of reported park access due to the walkability of the streets, quality, and size of the parks. Also, many parks are tourist attractions in Central Philadelphia, which draw people to the area, and these areas are comparatively safe and well-maintained.

6.1. Limitations

This study has several limitations to consider. First, the data were self-reported, so there could be information biases that affect outcomes. However, the PHMC HHS has a protocol to educate respondents about the confidentiality of their responses so that their survey information will not be linked to their identity. Second, the PHMC HHS is cross-sectional, so it is impossible to identify temporal relationships between exposure and outcome variables. Thus, our results are limited to those of association or correlation only. Third, the park access variable was measured by the item “Is there a park or other outdoor space in your neighborhood that you are comfortable visiting during the day?” Although this item identifies self-reported access to a neighborhood park, it does not specify the reasons for access (or lack of access), nor does it measure if and how much participants use parks. Fourth, gender was a binary variable in the dataset, and did not identify those reporting non-binary genders. Finally, a limitation of the GIS analysis was the difference in sample sizes between years. Among Philadelphia respondents who answered the parks question, there were 3,438 respondents in 2012, 3,601 respondents in 2015, but only 1,381 respondents in 2018. There were fewer responses in 2018 because only half of the original sample was asked Form A, which included the question on neighborhood park access. Despite these limitations, our analysis makes an important contribution to the literature. The study is the first to explore temporal trends and associations with park access among a population representative survey of adult Philadelphians and provides important information that can be used to advocate for increased access to Philadelphia parks.

CONCLUSION

Park access is not equitable between demographic groups and by geography among adults in Philadelphia. We identified that women, older age groups, minorities, those with lower educational attainment, and those living in neighborhoods with lower social capital had lower self-reported access to parks in Philadelphia. We identified that asthma and HBP were associated with lower self-reported access to parks, suggesting that park access may benefit health. The relationships identified between park access and health can inform advocacy for more high-quality, parks in Philadelphia, especially for those who currently do not have access.

REFERENCES

- Beyer, K M., Kaltenbach, A Szabo, S Bogar, F J. Nieto and K M. Malecki. "Exposure to neighborhood green space and mental health: evidence from the survey of the health of Wisconsin." *International Journal of Environmental Research and Public Health* 11 (2014): 3472.
- Centers for Disease Control and Prevention. "Recommendations for Keeping Parks and Green Space Accessible for Mental and Physical Health during COVID-19 and Other Pandemics." December 10, 2020. https://www.cdc.gov/pcd/issues/2020/20_0204.htm.
- City of Philadelphia. "Philadelphia Parks & Recreation." <https://www.phila.gov/departments/philadelphia-parks-recreation/> (retrieved November 23, 2020).
- Cohen, D A. and K J. Leuschner. "How can neighborhood parks be used to increase physical activity?" *Rand Health Quarterly*, 8(3), 4." (2019)
- Douglas, J A., R S. Archer and S E. Alexander. "Ecological determinants of respiratory health: Examining associations between asthma emergency department visits, diesel particulate matter, and public parks and open space in Los Angeles, California." *Preventive Medicine Reports* (2019): 100855.
- Engelberg, J K., T L. Conway, C Geremia, K L. Cain, B E. Saelens, K Glanz, L D. Frank and J F. Sallis. "Socioeconomic and race/ethnic disparities in observed park quality." *BMC Public Health* (2016): 395.
- ESRI. "ArcGIS Online." ESRI. 2020. <https://www.esri.com/en-us/arcgis/products/arcgis-online/overview>.
- Frumkin, Howard, Gregory N. Bratman, Sara Jo Breslow, Bobby Cochran, Peter H. Kahn Jr, Joshua J. Lawler, Phillip S. Levin et al. Nature contact and human health: A research agenda. *Environmental Health Perspectives* 125, no. 7 (2017): 075001.
- Grazuleviciene, R, S Andrusaityte, T Gražulevičius, and A Dèdelé. Neighborhood social and built environment and disparities in the risk of hypertension: A cross-sectional study. *International Journal of Environmental Research and Public Health* 17, no. 20 (2020): 7696.
- IBM Corp. IBM SPSS Statistics for Windows. V. 26.0. IBM Corp. 2019.
- Knobel, P., M Kondo, R Maneja, Y Zhao, P Dadvand, L Schinasi. "Associations of objective and perceived greenness measures with cardiovascular risk factors in Philadelphia, PA: A spatial analysis." *Environmental Research* 2021, 197, 110990.
- Morita, E., M Naito, A Hishida, K Wakai, A Mori, Y Asai, R Okada, S Kawai, N Hamajima. "No association between the frequency of forest walking and blood pressure levels or the prevalence of hypertension in a cross-sectional study of a Japanese population." *Environ Health Prev Med* 2011, 6, 299–306.
- OpenDataPhilly. "Datasets." <https://opendataphilly.org/dataset> (retrieved November 11, 2020).
- Park, S, B Han, D A. Cohen and K P. Derose. "Contributions of Neighborhood Parks to Physical Activity in High-Poverty Urban Neighborhoods." *Journal of Urban Health* 95 (2018): 887.
- Pearsall, H and J K. Eller. "Locating the green space paradox: A study of gentrification and public green space accessibility in Philadelphia, Pennsylvania." *Landscape and Urban Planning* (2020): 103708.
- Public Health Management Corporation. "PHMC Community Health Data Base Launches 2018 Household Health Survey." August 30 2018. <https://www.phmc.org/site/newsroom/press/103-press-releases/2018/1277-phmc-community-health-data-base-launches-2018-household-health-survey> (retrieved November 5, 2020).
- Razani, N, S Morshed, M A. Kohn, N M. Wells, D Thompson, M Alqassari, A Agodi, and G W. Rutherford. "Effect of park prescriptions with and without group visits to parks on stress reduction in low-income parents: SHINE randomized trial." *PloS one* 13, no. 2 (2018): e0192921.
- Schipperijn, J, E Cerin and M Adams. "Access to parks and physical activity: an eight country comparison." *Urban Forestry & Urban Greening* (2017): 263.
- Sefcik, J S., M C. Kondo, H Klusaritz, E Sarantschin, S Solomon, A Roepke, E C. South and S F. Jacoby. "Perceptions of nature and access to green space in four urban neighborhoods." *International Journal of Environmental Research and Public Health* 16 (2019)
- Shukla, Aseem and Michaelle Bond. "Philly Is One of the Most Segregated Cities in America." <https://www.inquirer.com>. *The Philadelphia Inquirer*, October 21, 2021. <https://www.inquirer.com/news/philadelphia/inq2/philadelphia-racial-segregation-remains-high-census-analysis-20211019.html>.
- South, E C., B C. Hohl, M C. Kondo, J M. MacDonald and C C. Branas. "Effect of Greening Vacant Land on Mental Health of Community-Dwelling Adults: A Cluster Randomized Trial." *JAMA Network Open* 1 (2018): e180298.

Intercultural Suburbs: The Urban Design Alternatives of International Immigrants in Toronto's Modern Landscapes

Giacomo Valzania¹

¹McGill University, Montréal, CANADA

ABSTRACT: This paper presents a selection of findings from ongoing research on the spatial adaptation of international immigrants in suburban Toronto. Current growth-oriented reurbanization is transforming modernist neighborhoods in a severe albeit uneven way. Despite most residents being foreign-born, official participatory initiatives on planning and urban design matters have paid lip service to diversity so far. In response, this research project engaged international immigrants in intercultural focus groups on the transformation of four suburban stretches. Based on shared preparatory material, the activities aimed at the inclusive dialogue between residents from the same areas, but who identify themselves differently from an array of features (e.g., origin, language, tenure, etc.). While several approaches to suburban transformation are possible, participants were invited to propose solutions that would enhance walking, better use of available open spaces, and socially acceptable densification. A focus on “collective attractors” (i.e., public-oriented buildings and sites under different ownerships) led to two major findings. First, this paper shows the legacy of modernism in shaping everyday practices and perspectives over residents’ living environments. Across differences, local affection and challenges suggest adopting an anti-ideological stance in transformation, to strike a balance between the conservation of buildings and sites’ qualities, and the need for change. Second, the paper builds on residents’ multiple ideas to highlight the relevance of the urban design principles of *porosity*, *adaptive reuse*, and *stacked density*. Taken together, these hold potential to orient future research and professional efforts on the inclusive transition of modern landscapes.

KEYWORDS: Inclusive Urban Landscapes, Reurbanization, Interculturalism, Modernist Suburbs, Focus Group

INTRODUCTION

Planned from the 1950s and developed throughout the 1970s, Toronto's modernist suburbs have been an exception to the North American canon. Combining key principles of welfare urbanism from Northern Europe (Carver 1962; Cook 2018) with the “neighborhood unit” model (Brody 2013), planners established a “template” made of a hierarchical road system, measured mix of segregated activities, and networked green spaces that they perceived as vital to residents’ well-being (Hancock 1968, 210). Relatively higher population densities allowed the development of a far-reaching transit service. Moreover, the diversity of tenure models (from social housing to homeownership) and residential types (from detached dwellings to high-rise apartments) has historically produced a socioeconomic mix. Nonetheless, starting in the 1980s, many observers have criticized modernist suburbs as generic sprawl, lamenting ecological degradation, the loss of farmland, the dullness of buildings, the fragmentation of activity spaces and the consequent dependency on private vehicles (Curic & Bunting 2006; Frisken 2001; Sewell 2009).

Since the 1998 amalgamation of the Municipality of Metropolitan Toronto and its local governments into the current City of Toronto, the planning milieu has celebrated pre-war and downtown urbanism. Meanwhile, the coarse zoning-based distinction between (low-rise) “neighborhoods” and “apartment neighborhoods” overshadowed the specificity of suburban landscapes (City of Toronto 2002). Pro-growth provincial policies (Ontario 2005) have increasingly favored the market-led “hard densification” (c.f. Touati-Morel 2015) of suburbs around rapid transit nodes, along arterial roads, and in former brownfields. More recently, development started replacing functional commercial plazas and filling the private open spaces of rental apartment buildings, while low-rise neighborhoods continue to be protected. So far, reurbanization has neither proposed approaches reflecting suburbs’ original comprehensiveness, nor solved the city’s growing housing crisis, quite the opposite (Moos et al. 2018). Besides, little effort has been dedicated to listening to “what insiders have to say,” as Harris urges for a meaningful understanding of the suburban present (2010, 16). In Toronto, this call has never been so important as in times when poverty increasingly correlates with immigration status (Hulchanski 2011) and immigrants are the suburban majority. While residents tenderly compare their communities to the United Nations (personal interviews), their underrepresentation in planning and urban design matters clashes with the boasted multiculturalism of official discourses (Goonewardena & Kipfer 2005).

My primary aim is neither to critique, nor to defend, any specific urban design theory or practice for the transformation of modern (sub)urbanism, in Toronto or elsewhere. Instead, I wish to enhance the space of community voices in theory

and practice through empirical work. During summer 2021, six online focus groups engaged 25 international immigrants from the suburbs of Don Valley North (North York) and Agincourt (Scarborough). Both areas were developed in the 1960s and 1970s based on two district plans by the same planning consultant (Project & Planning Associates, Ltd.). As a major difference, the 2002 arrival of a new subway line in Don Valley North enhanced its connection with the rest of the city and accelerated urban transformation. As such, a comparison with Agincourt is particularly useful to assess community experience within similar areas that have undergone very different redevelopment trajectories. The focus groups challenged residents to answer, for a total of four “stretches” from the two suburbs, the following research question: *What should be done for better walking, use of the available space, and appropriate population increase?* After presenting the application of interculturalism in the research method, this paper shows practices and desires for the improvement of “collective attractors,” namely buildings and sites under several ownerships that residents visit daily to satisfy vital and social needs (e.g., commercial buildings, community center, schools, etc.). The collective vocation of these sites and the utopian openness of their initial plans generate a tension with their current property regime. Across different identities, opinions, and spaces, residents’ narratives revealed the persisting legacy of modernism in shaping individual perspectives. While generalizations about how collective attractors *should* be transformed would overlook the specificity of each site, the findings from the focus groups proved the usefulness of three urban design concepts to achieve socially acceptable and ecologically sound solutions: *porosity, adaptive reuse, and stacked density*. Given the limits of this project, these principles will require further research to test their validity for future practice in suburban landscapes.

1.0 RESEARCH METHOD: INTERCULTURAL FOCUS GROUPS

Since the modernist suburbs of Agincourt and Don Valley North were completed in the 1970s, immigrant communities have steadily grown in both areas. The most recent demographic data for the neighborhoods considered in this study show that foreign-born residents form 65.1% of the population in L’Amoreaux (Agincourt) compared to 66.6% in Don Valley Village (Don Valley North) (City of Toronto 2016). Currently, Chinese immigrants are the majority in both areas and prevail among homeowners (of any building type), while the tenant population is more diverse as per country of origin. All participants in the online focus groups had been individually interviewed as part of a larger research project on their spatial integration in modernist suburbs. Completed either by phone or via an online conference platform, the semi-structured interviews explored residents’ housing and urban space experience. Moreover, participants were asked to comment on episodes of redevelopment, recurrent ideas of suburban retrofit (e.g., secondary suites, “missing middle,” mix of uses, etc.) and suggest priorities. The findings from the interviews inspired the selection of four suburban “stretches” for group discussion, two from each area. Among 80 participants, 42 were shortlisted based on their comfort with video conference platforms and interaction in English. In organizing the groups, internal diversity was pursued across several criteria. Of 42 invited residents, 30 confirmed their participation, and 25 attended. Table 1 shows the composition of the groups based on the selected suburban stretches.

Suburban stretch	Group	Attendance	Gender		Age group		Dwelling & Tenure		Country of origin		Years in Canada area	
			♀	♂	50s	30s	20s	50s	20s	40s	20s	40s
1 Scarborough-Agincourt: <i>Finch & Warden</i> shopping mall commercial plaza high-rises //	A	5 / 5	♀ 50s	♂ 30s	● 18 13	● 23 2	● MY 21 20	● CN 18 18	● CN 18 18	● CN 18 18	● CN 18 18	● CN 18 18
	B	5 / 5	♀ 40s	♀ 50s	● 18 7	● TZ 11 11	● CN 19 18	● AF 17 14	● CN 19 18	● CN 19 18	● CN 19 18	● CN 19 18
2 Scarborough-Agincourt: <i>Beverly Glen</i> park hydro corridor school low-rises	C	3 / 5	♀ 30s	♀ 40s	● 21 8	● CN 20 16	● PK 15 6	● CN 19 19	● CN 19 19	● CN 19 19	● CN 19 19	● CN 19 19
3 Don Valley North: <i>Don Valley Village South</i> high-rises community center & high-rises	D	3 / 5	♂ 30s	♀ 30s	● IN 5 5	● AM 15 4	● TR 23 20	● CN 27 13	● CN 27 13	● CN 27 13	● CN 27 13	● CN 27 13
	E	4 / 5	♂ 20s	♂ 40s	● SA 11 3	● PK 26 11	● CN 5 1	● CN 21 13	● CN 21 13	● CN 21 13	● CN 21 13	● CN 21 13
4 Don Valley North: <i>Don Valley Village North</i> park commercial plaza low-rises park //	F	5 / 5	♀ 40s	♀ 30s	● IN 11 11	● CN 20 11	● IN 4 4	● CN 22 19	● CN 22 19	● CN 22 19	● CN 22 19	● CN 22 19

Table 1: Composition of the focus groups. In blue those residents who confirmed but did not participate. Legend: Dwelling [● High-rise, ● Townhouse, ● Semi-detached house, ● Detached house]; Tenure [O : Owner, R : Renter, P : Living with parents].

An intercultural approach inspired the organization of the focus groups and the following analysis of findings, so as to promote the contribution of minorities beyond multicultural inclusion and representation. As Amin contends, In a democratic multiethnic society, if community cohesion remains elusive, the key challenge is to strike a balance between cultural autonomy and social solidarity, so that the former does not lapse into separatist and essentialised identities and so that the latter does not slide into minority cultural assimilation and Western conformity (2002).

Compared to institutions, experts of the built environment, landlords and developers, the engaged residents shared an undeniable disempowerment and ingenuity. Therefore, a specific effort was put into understanding common desires, and moving beyond the opposition of individual interests and worldviews that often paralyze public participation to the advantage of a few dominant actors. Admittedly, an intercultural focus on convergences de-emphasizes the relation between identity features and opinions. However, it does not ignore the micro imbalances that precede, influence, and

endure “intercultural contacts” (Kramsh & Uryu 2020), quite the contrary. In this case, the focus groups revealed that in “super-diverse” communities (Vertovec 2007) power differences can play out (non-exclusively) along ethnic, gender, generation, and knowledge lines. Beyond aiming for diversity in pre-selecting and assembling participants, equal opportunities of engagement were pursued by creating a website that was accessible before the activities. The author coordinated three master’s students for the production and online presentation of preparatory material. This included, for each suburban stretch, an original video, a short description, and before-and-after drawings on possibilities of transformations (Fig. 1); the abstract character of the latter aimed at clarifying technical concepts (e.g., “garden suite”), without foreclosing the following discussion of multiple alternatives.



Figure 1: Sample of online preparatory material for the focus groups: video (left) and site specific before-and-after drawings (right).

The author and a rotating student from the team co-led each focus group, to convey the feeling of being part of an informal and inclusive conversation. During the first ten minutes of the one-hour activity, residents were informed about ethical issues and introduced to the stretch by watching the video; a forty-five-minute period was then dedicated to answering the research question. As the activity progressed, the order of interventions was revised, and quieter participants were invited to speak to achieve a more balanced contribution. The last five minutes were used for open-ended comments and thanking, after which participants received a modest reward.

In support of the online discussions, a base satellite 3D map or a street view image was shown via screen sharing, while the dashboard function of the conference platform permitted sketching what residents described, to make suggestions more explicit and stimulate reactions. Two question styles were used to generate answers: *open* questions invited participants to answer the overarching research question for a building or a site. Instead, *semi-open* questions specifically asked them to comment on and revise previous ideas or drawings. In the case of collective attractors, open questions prevailed. The following narrative connects opinions to sites and individuals by using the group code (A, ..., F) and participants’ “positions” in Table 1.¹ As semi-open questions were more likely to influence contributions, even more so in a group setting, the code [SO] is added in this case. Last, when opinions closely adhere to drawings or thoughts that were previously proposed by the research team or other participants, the code [R] is included too. The following site-specific collages (Fig. 3, 5, 6) gather the multiple ideas that emerged during the conversations, instead of synthesizing them into coherent and “final” urban design solutions.

2.0 POROUS, ADAPTABLE AND VERTICAL: IMAGINING MODERNIST COLLECTIVE ATTRACTORS

2.1 Porosity

If you’re living [in this community], you see lots of fencing and disconnect in the way it is deliberately designed. You see lots of accessibility issues where people are not encouraged to walk or connect. Either you will see fences, or no benches in the parks, just *white* spaces. So [landlords] are not encouraging the community to come in and enjoy (E2).

Differently from their North European coeval references, Toronto’s modernist suburbs have been largely developed under a private land ownership regime. The metropolitan and local governments extracted public property for infrastructure, parks, green corridors, and institutional buildings in return for development rights. Despite the comprehensiveness of district plans, and the proximity of community-oriented activities, private property has gradually reclaimed “open” (Fishman 2011) sites along their boundaries. Schools, shopping malls, commercial plazas, churches, and collective residential spaces have been increasingly surrounded by fences and equipped by an apparatus of signs and cameras against trespassing. Syed (E2), a long-term resident from Pakistan, laments about disconnection while looking at the 200 m-long chain-link fence between a popular school ground and the busy “Peanut Plaza” in Don Valley North (Stretch 4). Occasionally, contiguous green spaces are divided too. In the 1960s, the district plan for the Northwest Sector of Scarborough (currently Agincourt) integrated a major hydro corridor as a de facto public greenway to connect pedestrians to neighborhood parks and public schools. A few decades later, the courtyard of the Beverly Glen Junior School was fenced off from the corridor, despite both remaining accessible; the partial redevelopment of the corridor for new housing in the early 2000s (Fig. 2) didn’t solve the issue. Grace, who joined the community with her parents from China in those years, commented on the persisting boundary:

In this case, because the fence is between two parks, I don’t really see the point of having [it]. I think it will be much better to just remove [it], so that it becomes a more open space for people to walk around. (C1 [SO, R])



Figure 2: Agincourt: examples of boundaries and thresholds in collective attractors. Source (left): Google Maps.

These several episodes of fragmentation exemplify what Ellin aptly called “Form follows fear” in her critique of postmodern urbanism (1999). Against it, vernacular suburban practices and narratives reveal the importance of *porosity* as a concept to orient the future transformation of modernist post-war landscapes (Viganò 2018). With time, residents have responded to separation by introducing several breaks in the fences of collective attractors. These add to multiple “desire paths” and informal appropriations of green verges, as for vegetable stalls next to gas stations and parks (Fig. 2, right). Using an ecological perspective, Díaz Montgomery and Kamel have conceived these suburban spaces as “ecotones,” which diverse populations appropriate to “transgress and redefine established sociospatial boundaries—functionally, institutionally, and materially” (2015, 201). Practices at the margin of sites further accentuate the crossing that is already incited by buildings and neighboring destinations. Looking at the parking lot behind a commercial plaza and a professional building in Agincourt (Fig. 3, Stretch 1), Vivian, a long-term resident from China, told us:

This area is good for the passengers, like the people who walk. I usually go across it, like a shortcut from where I live, instead of walking all around [the street]. (A4)

When alternative scenarios for collective attractors are discussed, residents invariably focus on entry points and internal connections to enhance free and protected movement. Using the site above as an example, members from two group discussions agreed on the idea of pushing the peripheral rows of parking inward (B4, B5 [SO, R])—or, alternatively, the residential fences outward (A2 [SO])—to add two pedestrian and bike lanes. While vehicular traffic from the roundabout at the back should remain interrupted, a more defined sidewalk (B5 [SO, R]) or a more permeable boundary of vertical posts (B4 [SO]) may replace the existing stanchions and chain. The fence at the end of one verge was proposed to be removed for an additional entry point from the sidewalk (A3 [SO, R]). Finally, participants suggested introducing benches along the new paths (B4). As a result, the compendium of ideas formalized the movements that residents already trace and struck a balance between site conditions and current needs (Fig. 3).



Figure 3: Commercial site in Agincourt (Stretch 1): collage of residents’ suggestions. Source (left): Author after Google Maps.

As the example above suggests, greening is an essential element of open space revitalization. But as public parks are abundant in modernist suburbs, residents propose the landscaping of parking lots to introduce pedestrian connections, contain and reorder vehicular traffic (B1), enhance aesthetics (A1) and increase shading (B3, E4), rather than to add new parkettes. Yet, more points of access and green connections do not improve the link to collective attractors from the other side of arterial roads. Planners in the 1960s had partially addressed this problem by introducing, as in their North European references, pedestrian underpasses. Two of them used to connect the Peanut Plaza in Don Valley North under the curvy and heavily trafficked Don Mills Rd (Stretch 4), but were closed off soon after the local planning office spotted overturned shopping carts and garbage.

The addition of crosswalks on arterial roads has not solved the conflicts between drivers and pedestrians. After having heard an argument for more crossing points, Indian long-term resident Aadya replied:

I often go towards Peanut Plaza for shopping; plus both my children were in school at Woodbine [Middle School] as well as Vanier [Secondary School]. [As] a driver, [I think] there are too many signals and, sometimes, when you’re stopping but there’s nobody crossing, it does get a little annoying. (F1)

As a compromise between these tensions, a fellow resident called for mutual patience (F5), while others suggested the addition of green light-triggered only crosswalks in strategic locations (D2; B3). Yet, someone argued that traffic separation—a solution that the current debate on “complete streets” categorically excludes (City of Toronto, n.a.)—is still worth consideration. In her ethnographic work on the Swedish Million Programme, Mack arrives at a similar conclusion after showing popular affection for tunnels and bridges (2021). While, in her account, long-term residents feel a nostalgia for urban elements that institutions make “impossible,” immigrants in Toronto propose (self-admittedly) utopian overpasses as an attractive idea for the suburban present (F1; B2; D5 [SO, R]). Beyond a question of actual feasibility, the key point is that both planning failures (e.g., the reliance on private vehicles: E1) and successes (e.g., the continuous networks of public trails and parks: D2) still shape the everyday experience of residents. Being modernist suburbs an exception, taking disconnection into serious consideration means working out specific solutions based on the existing intensities and frictions of movements across property and infrastructure.

2.2 Adaptive reuse

Despite the current hegemony of hard densification, ethnographic work in modernist suburbs revealed a shared preference for the *adaptive reuse* of buildings and open spaces, as the comparative analysis of areas with different redevelopment trajectories demonstrates. In Don Valley North, tall buildings sitting on street-oriented podiums have replaced low-rise structures and private open spaces after a subway line opened 20 years ago (Fig. 4, left). Based on their experiences, residents in Don Valley North overwhelmingly disagree with replicas of the same approach for collective attractors. Eschewing NIMBY arguments (e.g., the opposition to population growth per se), they blame developers and the government for having reduced private green spaces (E2), increased traffic and shade in public space (F1), and provided insufficient affordable housing (B2) and community services (D4) in return for rezoning rights. This approach has penalized all generations, but mostly children and seniors who depend more on accessible amenities. While immigrant parents flag the congestion of playgrounds (F3) and sports facilities (D3), Cecilia, a long-term resident from China who considers the neighborhood community center her “second home” laments:

I’m not a supporter of condominiums because, in 20 years, I have seen only one library [being built] but no [other] increase in services. I’ve seen many people move to this location because transportation is so convenient, but it’s very crowded! [...] I want [buildings] to be more separate, they are very close to each other! From the balconies, you can say hello [to others], you can even smell their cooking, so they are close! (D4)



Figure 4: Densification trends: infill of apartment towers (left), and previous (center) and future (right) replacement of attractors.

Therefore, recent development trends in Don Valley North discouraged residents’ discussions about pro-growth urban strategies for collective attractors. Quite surprisingly for the research team, a similar discomfort existed in Agincourt for larger and less used sites. This is the case of the Bridlewood Mall, where a redevelopment scheme, approved in 2010 but never implemented, aimed to replace one ancillary building and wide sections of the parking lot with 975 residential units in towers on podiums and slabs (from 10 to 25 stories). The commercial surface was planned to expand by 20%, while cash in lieu was to supplant the direct provision of parkland. Rather than similar macroscopic ambitions, participants in the focus groups prioritized the adaptive reuse of the mall and its ancillary buildings (Fig. 5). Here as in Don Valley North, this soft approach reflects shared affection for both ethnic-specific services (mostly among the Chinese community) and “third” spaces such as cafés, gyms, and public libraries as settings for social life. Residents appreciate unprogrammed catchment areas like porticos and hallways too, as suggested by their informal occupation of the Bridlewood Mall upper atrium for tai chi winter classes. These community practices scale down conventional urban strategies and prioritize the “intensity” of sites over their “density” (as discussed by Dovey & Pafka 2014). Participants showed a common preoccupation with diversifying the commercial offer (E3), preventing businesses from closing (F5, A4) or being replaced by less inclusive activities. Mark, a young man from Malaysia who has lived his childhood in Agincourt, proposed for the Bridlewood Mall:

It may be extended more or have more hangout places. I know a lot of seniors who, in the morning, would love to chat and have a coffee. The food court is pretty packed [...]. I would like to see more social spots. (A3)

Adapting a mall does not mean confirming its exterior materiality. Instead, residents suggested enhancing “transparency” (Ewig & Handy 2009) between indoor and outdoor space for complementary activities, such as a summer fitness station facing the existing gym (B1), or patios and larger pedestrian zones in front of restaurants and cafés (A3). Overall, desires for conserving while adapting buildings and interfaces, as expressed by residents from different backgrounds and socioeconomic situations, diverts from calls to replace them as a requirement for sustainability (e.g., Duany et al. 2000). As Guattari’s work reminds us (2008), ecology is a process with social goals (too), which cannot be disjoined from environmental recovery. Both demand careful interventions in actual contexts.



Figure 5: The Bridlewood Mall in Agincourt (Site 1): collage of residents' suggestions. Source (left): Author after Google Maps

Residents' preference for adaptive reuse exceeds buildings and their interfaces to regard open spaces at large. Compared to current infill development that capitalizes on the latter via permanent occupation, communities saw open spaces as grounds with sets of affordances, as suggested by the recurrent organization of the circus, vintage car rallies, and theme parks. Grasping residents' enjoyment of these events help explain their otherwise odd complacency with the size of the Bridlewood Mall parking lot (A4, A5, B2, B3, B5). In their view, revitalization should therefore preserve a multiplicity of uses across different levels of permanency (see, for example, Lateral Office's take on "flat space": 2008). Proposals from the focus groups included the strategic sharing of parking among contiguous sites (B4), the expansion of sitting opportunities (A5, F5) and the construction of outdoor restrooms in both gray and green spaces (A3). Moreover, ideas such as adding a removable winter dome on top of the running truck in Don Valley North (F5) showed the importance of seasonality. Finally, the reuse of open spaces was seen as an opportunity for affirming local diversity beyond institutional discourses and practices, as Alice from China explained:

How about we put some pictures or something that can show our community, our *true* culture here. Toronto is multicultural, right? It is where people live together. We may know our culture very well, but [there are] other cultures that we don't know that much. (B1)

2.3 Stacked density

While participants tended to oppose development of new housing as currently implemented, they were willing to consider densification as an opportunity to add community services and businesses. During the discussion, the preference for expanding within buildings' footprints, rather than on free ground, emerged quite consistently. For example, Cindy, a Chinese homeowner from Don Valley North, commented on the site of the Peanut Plaza:

Adding new floors, that will be excellent, and [buildings] will have a lot more space for community use. But I don't like the idea that [landowners] are building on the grass or using the open spaces. (F2, [SO])

I suggest *stacked density* as a guiding concept for the socially acceptable densification of collective attractors. I do so to underpin the importance of mixing activities upon an *already* occupied ground. Stacked density diverges from modernism zoning-based separation of uses, as well as from current reurbanization that either nullifies functional diversity (e.g., by replacing commercial plazas with housing) or misinterprets it as the inclusion of a few non-essential services (e.g., real estate offices). At the same time, stacked density is not captured by an influential theory on "vertical urban design" as Yeang's (2002), insofar as the latter abandon itself to the logics of hyper-development and excludes the conservation of program-free spaces as a driver for organizing activities vertically. In fact, participants in this project never framed vertical addition as a surrogate for open spaces.

Depending on the size and perceived social value of buildings, participants suggested several alternatives for a more intense use of land (Fig. 6). Small structures, such as the one-story ancillary buildings surrounding the Bridlewood Mall, were proposed—mostly by young professionals—to be replaced with brand-new taller buildings on the same footprint. Contrasted opinions emerged about including housing (A2 [SO, R]) instead of just employment (B5 [SO, R]), but agreement existed about having businesses and community services on the lower levels, and introducing amenities for the younger generations (B2, B4). Conversely, the expansion of larger buildings like commercial plazas and malls was suggested through the addition of new volumes on top of them. A more cautious approach proposed to add entire floors gradually, in proportion to community needs (A5, D4 [SO, R]). A more audacious one promoted high-rise additions on parts of the buildings. For Jennifer, a young Chinese professional, the commercial plaza in Agincourt discussed before (Fig. 3) can change as follows:

If, say, the pharmacy can be moved to this section, a corner or maybe half of the building, like on the right side, can have a high-rise. Then, the left half of the building may be two stories, or not so high, so we can increase commercial space. (A2 [SO])

Exceptionally, one long-term resident (E2) mentioned the recent revitalization of the Don Mills shopping mall as a reference to transform the Peanut Plaza into a more fine-grained system with a pedestrian area (Fig. 6). Finally,

residents identified the accommodation of private vehicles as the major common challenge for densification. Underground parking (B3, E4), which is already provided in suburbs under the open spaces of modernist multifamily buildings, was perceived as a necessary compensation to development, but also as an additional opportunity to make a wiser use of open spaces by planting trees and including pedestrian paths.



Figure 6: Peanut Plaza in Don Valley North (Site 4): collage of residents' suggestions. Source (left): Author after Google Maps.

CONCLUSION

Since the last three decades, Toronto has undergone rapid urban transformation under a pro-growth urban regime. Modernist suburbs, a specific type of post-war development built between the early 1960s and the late 1970s, exemplify the uneven implementation of density across the city, where the most affluent residential areas are protected, and other sites intensively transformed. Meanwhile, the participation of diverse suburban communities in planning and urban design matters has been residual and reactive in character. In response, this research set out to understand international immigrants' preoccupations and hopes about the change of their living environments. By adopting an intercultural approach that favors convergences across differences, this project strived for the active and inclusionary contribution of members with diverse identity features and levels of knowledge. A series of focus groups on four suburban stretches explored the case of "collective attractors," namely buildings and sites under public or private property that residents visit for basic and social needs. How should these places change to enhance walkability, better use of space and an appropriate population increase?

Within its geographic limits and small sample of participants, this research discovered the legacy of modernism in shaping residents' preoccupations and desires about the transformation of collective attractors. Everyday practices, with their joys and struggles, highlight that ideological rejection or celebration of suburban space would fail to grasp its evolving qualities and issues. Among the former, residents identified sites' open layout, buildings' programmatic diversity, and the social and environmental capital of both; among the latter, participants lamented the increasing disconnection caused by physical barriers and infrastructure, the difficult coexistence of pedestrians and vehicles, the unwise management of indoor and outdoor spaces, and the proportional decrease of community services compared to new housing. As such, immigrant experiences in modernist suburbs support fine-grained adjustment to the current spatial articulation and the programmatic organization of sites, rather than grand gestures concerning buildings' form. From this perspective, urban transformation is likely to become more socially acceptable where public administrations proactively engage multiple landowners, stakeholders, and communities in joint efforts.

General claims about how collective attractors (and modernist suburbs) *should* change would downplay the complexity of each case. At the same time, the focus groups highlighted the relevance of three foundational urban design principles to grasp commonalities among residents' suggestions. I contend that, if considered together, *porosity*, *adaptive reuse* and *stacked density* are promising concepts for a socially acceptable transformation. Porosity enhances free and protected movement through and between sites; adaptive reuse introduces new permanent services and temporary activities in indoor and outdoor spaces; finally, stacked density "saves" ground to expand buildings on already-developed areas. These ideas should not be reified in any "best practice" or design guideline, but rather help practitioners to confront community demands prior, during, and after transformation. For researchers and educators working on the ethnographies of suburban landscapes, the validation of these principles will certainly require more extensive inquiry, notably through detailed surveys on specific phenomena or elements, which may even overturn these preliminary conclusions, mostly as the focus shifts toward residential sites. Finally, future analysis may produce further insights on the relation between the proposed urban design principles and identity features, which this study did not explore sufficiently given its scope and methodological approach.

ACKNOWLEDGEMENTS

The research behind this paper received fundings by the *Fonds de Recherche du Québec Société Culture* and the *Peter Guo-Hua Fu* School of Architecture at McGill University. I wish to thank Nik Luka and three anonymous reviewers for their comments on a previous version of the paper, Nicolas Therrien for proofreading, Hanbo Jia for participant recruitment, and residents in Toronto for their engagement. Last, I dedicate this work to Dominique Boulet-Garuk, Jacee Kaczmar, and Kyle Rouhani, whose collaboration has been essential and enjoyable.

REFERENCES

- Amin, A. 2002. Ethnicity and the multicultural city: living with diversity. *Environment and Planning A: Economy and Space*, 34(6), 959–980. <https://doi.org/10.1068/a3537>
- Brody, J. 2013. The neighborhood unit concept and the shaping of land planning in the United States 1912–1968. *Journal of Urban Design*, 18(3), 340–362. <https://doi.org/10.1080/13574809.2013.800453>
- Carver, H. 1962. *Cities in the suburbs*. Toronto: University of Toronto Press.
- City of Toronto. 2002 (2019). *Toronto Official Plan*, Office Consolidation, February 2019. Retrieved from: [link](#)
- City of Toronto. 2016. *Neighborhood profiles*. Retrieved from: [link](#)
- City of Toronto. n.a. *Complete Streets Guidelines*. Retrieved from: [link](#)
- Cook, I. R. 2018. Suburban policy mobilities: examining North American post-war engagements with Vällingby, Stockholm. *Geografiska Annaler: Series B*, 100(4), 343–358. <https://doi.org/10.1080/04353684.2018.1428495>
- Curic, T., and Bunting, T. 2006. Does “compatible” mean “same as”? Lessons learned from the residential intensification of surplus hydro lands in four older suburban neighborhoods in the city of Toronto. *Canadian Journal of Urban Research*, 15, 202–224.
- Díaz Montemayor, G. and Kamel, N. 2015. Spaces of Indeterminacy. From Thresholds to Ecotones in Retrofitting Sprawl. In Talen, E. (Ed.). *Retrofitting sprawl: Addressing seventy years of failed urban form*. Athens: University of Georgia Press, 199–216.
- Dovey, K., and Pafka, E. 2014. The urban density assemblage: Modelling multiple measures. *Urban Design International*, 19(1), 66–76. <https://doi.org/10.1057/udi.2013.13>
- Duany, A., Plater-Zyberk, E., and Speck, J. 2000. *Suburban nation: The rise of sprawl and the decline of the American dream* (1st ed.). New York: North Point Press.
- Ellin, N. 1999. *Postmodern urbanism*. London: Blackwell.
- Ewing, R. and Handy, S. 2009. Measuring the Unmeasurable: Urban Design Qualities Related to Walkability. *Journal of Urban Design*, 14(1), 65–84. <http://dx.doi.org/10.1080/13574800802451155>
- Fishman, R. 2011. The open and the enclosed: Shifting paradigms in modern urban design. In T. Banerjee and Loukaitou-Sideris, A. (Eds.). *Companion to urban design*. New York: Routledge, 30–40.
- Friskin, F. 2001. The Toronto story: sober reflections on fifty years of experiments with regional governance, *Journal of Urban Affairs*, 23, 513–541. <https://doi.org/10.1111/0735-2166.00104>
- Goonewardena, K., and Kipfer, S. 2005. Spaces of difference: reflections from Toronto on multiculturalism, bourgeois urbanism and the possibility of radical urban politics. *International Journal of Urban and Regional Research*, 29(3), 670–678. <https://doi.org/10.1111/j.1468-2427.2005.00611.x>
- Guattari, F. 2008 (1989). *The three ecologies*. London: Continuum.
- Hancock, M. 1968. Flemingdon Park, A New Urban Community. In Gertler, L. O. (Ed.). *Planning the Canadian environment*, 205–228. Montreal: Harvest House.
- Harris, R. 2010. Meaningful types in a world of suburbs. In Clapson, M. and Hutchinson, R. (Eds.). *Suburbanization in Global Society*. Bingley: Emerald, 15–47.
- Hulchanski, J. 2011. *The three cities within Toronto: income polarization among Toronto’s neighborhoods, 1970-2005*. Toronto: Cities Centre, University of Toronto.
- Kramsh, C., and Uryu, M. 2020. Intercultural contact, hybridity, and third space. In Jackson, J. (Ed.). *The Routledge handbook of language and intercultural communication*. New York: Routledge, 204–218.
- Lateral Office. 2008. Flatspace: Resurfacing Contemporary Public Space (2003-2007). In Walker Art Center (Ed.) *Worlds Away: New Suburban Landscapes*, Minneapolis, 235–241.
- Mack, J. 2021. Impossible nostalgia: green affect in the landscapes of the Swedish Million Programme. *Landscape Research*, 46(4), 558–573. <https://doi.org/10.1080/01426397.2020.1858248>
- Moos, M., Vinodrai, T., Revington, N. and Seasons, M. 2018. Planning for mixed use: Affordable for whom? *Journal of the American Planning Association*, 84(1), 7–20. <https://doi.org/10.1080/01944363.2017.1406315>
- Ontario. 2005. *Planning for Intensification*. Retrieved from : [link](#)
- Sewell, J. 2009. *The shape of the suburbs: Understanding Toronto’s sprawl*. Toronto: University of Toronto Press.
- Touati-Morel, A. (2015). Hard and soft densification policies in the Paris city-region. *International Journal of Urban & Regional Research*, 39(3), 603–612.
- Viganò, P. (2018). Porosity: Why This Figure Is Still Useful. In Wolfrum, S. (Ed.). *Porous city: from metaphor to urban agenda*. Basel: Birkhäuser, 49–53.
- Yeang, K. (2002). *Reinventing the skyscraper: a vertical theory of urban design*. Wiley-Academy.

ENDNOTES

- 1 For example, “D2” is an Armenian woman in her 30s who owns an apartment in a high-rise building, and has lived in Don Valley North for 15 years. In the narrative, fictitious names are used to protect personal identities.

Creating the “Foreign” Place through “Windows”: Shifting Urban Forms in Seattle’s Chinatown

Xiao Hu¹

¹University of Idaho, Moscow, ID

ABSTRACT: Chinatowns in North America are unique urban components of our cities – they emerged as the entry ports of “lands of opportunity” and an ethnic enclave in late 19th and early 20th century. After over 100 years of changes, Chinatowns have no longer served as a preferred place for new immigrants but still a critical site to celebrate their multicultural and multiethnic heritages. From an ethnic enclave to a marketable destination for leisure, tourism and entertainment, Chinatowns have kept producing unique urban forms that make cultural exotism visible and define the physical features of being “foreign” or “other” from their contexts. Contrast to conventional views that consider Chinatowns as a passive response to outside social, cultural, and political forces, this paper takes Seattle’s Chinatown as a case study and examines the changing meanings of urban forms over time and assesses those changes in a resilient perspective. By introducing the concept of “window” to explain the linkage between physical features of urban forms and the perceived meaning by users, this paper is aimed to understand urban forms in the Chinatown as an active instrument that create and develop “windows” to define and revise the relationship between the Chinatown and its surrounding urban contexts based on the needs of change. Through the “windows,” two parallel worlds can co-exist and interact, which allows the Chinatown to actively engage with the outside while keeping a cohesive but constantly shifting shared identity. Finally, this study will also discuss how the shifting shared identity gained by self-organized urban forms in Seattle’s Chinatown contributes to the capacity of cultural resilience for the community.

KEYWORDS: Chinatown, Ethnic Enclave, Urban Forms, Window

1.0 INTRODUCTION

Chinatowns in North America have emerged as a historically critical and unique urban environment in major cities such as New York, San Francisco, Chicago, and Boston, where multicultural and multiethnic identities become visible through the exotica of urban forms and distinct cultural practices and life patterns. Due to the noticeable differences of physical urban forms and human activities from the established mainstream norms of the host cities, Chinatowns are normally perceived as “foreign” or “other” places separated from their contexts, an ethnic enclave in the city. The “foreign” or “other” places marked both the physical and mental separation from the mainstream American urban contexts, which generated the mysterious and dangerous images of Chinatowns, as represented by Roman Polanski’s 1975 film *Chinatown* and Michael Cimino’s 1985 film *Year of the Dragon* (Lin, 1998).

Ethnic enclaves were products of “spatial sorting” (Lazear, 1999) driven by both the host cities’ segregation planning and the individual immigrants’ location decisions. In an unfamiliar and hostile environment, new immigrants tended to live closer with their fellow immigrants from the same ethnic group to overcome the barriers for critical information and resources. This “spatial sorting” created an ethnic concentration in a neighborhood that had social and economic structures diverging from those in the surrounding areas while offering a protective effect against a generally hostile climate facing immigrants and ethnic minorities and a pathway for social mobility (Espinoza-Kulick, Fennelly, Beck, & Castaneda, 2021). During the waves of immigration in the US history, there were many ethnic enclaves emerged in the major cities, such as the Little Havana in Miami for Cubans, Little Italy in Manhattan, NYC, South Boston for Irish people, and the Greek Town in NYC.

In the 20th century, many ethnic enclaves in the US experienced significant transformations – some neighborhoods were changed into different ethnic enclaves for new ethnic immigrants or minorities when the old ethnic residents moved out; and some were dissolved and transformed into new commercial /business districts to be a part of expanding downtown centers. However, the Chinatowns seemed to be exceptional from this change (Kwong, 1988). Most Chinatowns remained the centers of economic, social, and cultural lives of local ethnic Chinese communities today. Some scholars considered the consistent arrivals of large numbers of new Chinese immigrants from the 1960s to the 1990s critically contributed to Chinatowns’ survival when other ethnic enclaves were struggled in seeing new commers (Lin, 1998; Marcuse, 1997). Some scholars stressed the significance of the “foreign” or “other” characters of urban forms in Chinatowns that delivered an exotic experience for food, shopping and entertainment of foreign delicacy outside of the mainstream life (Lin, 1998; Klein & Zitcer, 2013; Nguyen, 2011).

Seattle's Chinatown is a key example that is characterized by the shifting images of a well-developed cultural enclave and the changing culture-based urban forms while maintaining a strong manifestation of ethnic Chinese culture. This paper, taking Seattle's Chinatown as a case study, examines the change of cultural representations from examples of culture-based urban forms over time and assesses those changes in a resilient perspective. Current studies of cultural representations in Chinatowns tend to view the urban forms as a passive response to outside social, cultural and political forces. Instead, this study considers the culture-based urban forms as an active instrument that defines the relationships between the Chinatown and its surrounding urban contexts based on the need of the residents of the Chinatown.

Started as temporary settlements in the 1860s, the Seattle's Chinatown (or the International District, renamed in 1999) is a historic neighborhood featured rich immigrant multiethnic cultures, colorful community lives, and home to many tourism-based amenities and ethnic Asian restaurants and businesses. Today's Chinatown is still the primary home for many immigrants mostly from East Asia, such as Chinese, Filipinos and Vietnamese. It has successfully changed from a segregated urban ghetto to one of the most vibrant and diverse communities in Seattle, featuring flourished Asian ethnic business and public collectivism. Being a multiethnic neighborhood located at the edge of the Downtown Seattle, it is also a place where cultural flavors and spatial representations are manifested in the built environment.

2. THE CHINATOWN AS THE MARK OF DIFFERENCES

There are two images of Seattle's Chinatown. The first is a historical neighborhood close to the Downtown with a few mixed-use buildings and tons of urban amenities for its residents and visitors. The second is characterized by various forms of Chinese culture, from the color of street-light poles and the unique storefronts to the street signs in foreign languages and decorations and peculiar souvenirs in oriental styles, which promote the cultural pluralism and exoticism of the place.

Those urban forms have highlighted something that are visually different from the familiar and known mainstream norms. The visual differences mark the border of the "local" or "we" for the urban center occupied by the white-dominated population and the "foreign" or "other" for the Chinatown occupied by Asian immigrants. Therefore, it is always intriguing to experience the "foreign" or "other" because the exoticism and unfamiliarity deliver an alluring attraction for curiosity.

Like other cities in the US, Seattle has been white dominated since its beginning. It is natural for the white residents to consider themselves to be the norm and the mainstream, the centered "local" or "we" while perceive everything else beyond its central domain as the peripheral "foreign" or "other" (Khan, 2015). In addition, this perception of "local" vs. "foreign" and "we" vs. "other" also implies a sense of positional hierarchy with "local" and "we" being regarded as superior and the "foreign" and "other" as inferior. Therefore, the "foreign" forms have promoted the widely accepted paradigm of the Chinatown, its residents, and events to be an exotic "others."

The beginning of Chinatowns in North America was a product of anti-immigrant movements in the 1800s and the Chinese Exclusion Act in 1882 (Lin, 1998). The inassimilable difference and the lack of language skills and social support reinforced their spatial marginalization and isolation from their urban contexts. The early urban forms of the Chinatown in Seattle were characterized by a concentration of Chinese immigrants and economic activities within one or more city blocks that formed a unique component of the urban fabric, which created "an idiosyncratic oriental community amidst an occidental urban environment" (Lai, 1988) and started the process of being "foreign" or "other." The first noticeable culture-based urban forms used in Seattle's Chinatown was the physical barriers that carried little cultural meanings or perceptions but was used to mark ethnic difference and cultural isolation for "foreigners" and "others". In the end of the 1880s and beginning of the 1900s, the anti-Chinese sentiment, exclusions from entering certain occupations and discrimination in the labor market led to the Chinese immigrants' concentration into certain retail and service occupations that were generally undesired by ordinary Americans (Lin, 1998). Like many other Chinatowns in North America, Seattle's Chinatown was formed in a marginal and undesirable land near the Downtown center (Abramson, Manzo, & Hou, 2006). Railroad tracks and industrial warehouses from the west, steep terrain to the north and east, and the undeveloped lands to the south isolated the Chinatown from other urban communities both visually and physically, despite the close distance to the Downtown.

The physical barriers that varied in different formats ranging from railroad tracks to topography made the physical boundary of the Chinatown clearly defined as a "other" place and separated it from its immediate surroundings. This physical isolation not only marked the different social, economic and ethnic status of the residents in the Chinatown and made them away from the mainstream society, but also fostered a strongly inward community that served as the cocoon of comfort zone and providing a home feeling to immigrants living there. It was the physical barriers that allowed the ethnic cultural representations to be possible within the Chinatown. Also, due to the Chinatown was physically isolated, the cultural & ethnic built forms could survive from the interventions of outside mainstream forces and started to grow into other urban forms.

The immediate change of urban forms with the Chinese immigrants' moving-in was the increasing street signs in Chinese characters and store fronts decorated with Chinese architectural elements, which reflected the active attempts to attract customers from Chinese immigrants and created "foreign" places in a white population dominated city. They demonstrated the increasing concentration of social and economic activities of Chinese immigrants within the Chinatown. Those early examples of culture-based forms were simple, humble, and attached to existing buildings, which echoed the general socioeconomic status of Chinese immigrants who lacked the economic and social /political resources to afford more complicated culture-based forms.

The Chin Gee Hee Building built in 1889 at the 2nd and Washing Street (Figure 1) by rich Chinese immigrants was an important example of how Chinese immigrants responded to being treated as "foreigners" or "others." This building was the first brick structure in Chinatown finished after the 1889 Great Seattle Fire. Its south façade was featured with a unique balcony that had a simplified Chinese hip roof with two Greek Ionic columns on both sides. This odd combination reflected an early example of grassroots approach towards a more cosmopolitan identity. The Chinese style roof indicated strong ethnic reflections of home culture while the Greek Ionic columns represented the desire of merging into the mainstream society. This example highlighted the dichotomous view hold by many Chinese immigrants: on one hand they wanted to retain their cultural connections to the home, which implied that they acknowledged the imposed identity as the "foreign" or the "other," different from other residents of the city; but on another hand, they were eager to end the social and physical isolation to join the mainstream, which reflected their acceptance of being socially inferior. Since the 1920s, residents of the Chinatown had more financial and social resource and more confidence to celebrate their cultural roots. In 1924, the completion of the Chinese Grand Opera Theater marked the first building in the Chinatown designed by a Chinese American architect, Wing Sam Chinn who was born in San Francisco and received architecture degree from the University of Washington (Ochsner, 2017). Its western façade, the main façade, used a simplified form of a traditional Chinese gateway – the façade had its central portion being taller and having more decorations sided by two identical portions, a typical design treatment used in traditional Chinese architecture to highlight the significance of the center. This form celebrated a stronger representation of ethnic elements, reflecting a stronger ethnic consciousness and defining a stronger "foreign" place. This style was also employed by several buildings in Seattle's Chinatown in later times. In addition, the development of a formal cultural facility for Chinese opera symbolized the fact that the Chinatown also became a center of Chinese immigrants' social activities.



Figure 1: Seattle's Chinatown in 1934. The Chin Gee Hee Building can be seen at the near left (University of Washington Library Special Collections 1934).

Since the 1960s, the City of Seattle attempted to remove the social and cultural isolation of the community and celebrate the new development of multiculturalism to promote tourism. With this changing context, the Chinatown was turned into an icon of "foreign" or "other" to be celebrated and protected. In order to demonstrate Seattle's multiculturalism, the Chinatown should be made more "Chinese" – in another word, to be more "foreign." Promoting architectural motifs and symbols of traditional China in urban forms becomes more reasonable and necessary.

The Hing Hay Park (Figure 2) was an example of efforts to commodify Seattle's Chinatown to be an affordable amusement of visiting a different culture by repackaging the "foreign" and "other" places. As the first formal public plaza within the Chinatown, the Hing Hay Park built in the 1970s was featured an authentic Chinese pavilion in the center and a unique pavement pattern based on the idea of Eight Diagram (Ba Gua), a traditional symbol of Taoism. The culturally based built forms used for the Hing Hay Park promoted the stereotypic image of the Chinatown being "foreign" and "distant", echoing typical visual perception of China by middle-class and upper-class white tourists.



Figure 2: The Chinese style pavilion inside the Hing Hay Park.

After 2000, new developments have continued the effort to reinforce the definition of "oriental otherness." More culture-based built forms have become more capitalized to sell exotic experience. Noticeable examples include: an authentic traditional Chinese gateway structure, the Chinatown Gate, marking the west entrance of the Chinatown in 2007 and a set of dragon decorations on streetlight poles. The 45-foot-tall Chinatown Gate, located at the corner of South King Street and the 5th Avenue, took the form of a traditional Chinese Pailou archway with authentic ornaments of various Chinese elements, highly similar to those in other Chinatowns in Vancouver, B.C., San Francisco, and Washington D.C. As a result, the border between the Chinatown and the Downtown Seattle was marked by a symbolic ethnic architecture that was used to epitomize a cultural difference to boost local distinctiveness.

All those efforts made the Chinatown more visually different from its surroundings, making it a designated landmark to offer a break from an ordinary urban life and to have an exotic experience without taking transpacific travel. The urban forms of the Chinatown were intentionally and deliberately manipulated to repackage symbolic representations of "foreign" cultures as the main means of place-making and place-branding. After enduring a long period of hostile treatments, racism and ignorance, the influx of multiculturalism and the exotic cultural characters in Chinatowns finally have become a unique asset that make Chinatowns marketable as the new destinations for leisure, tourism, and entertainment.

3. THE CHINATOWN AS A WINDOW FOR LINKAGE

As a product of social and spatial segregation, Chinatowns supported the transition of most immigrants to a new place by offering opportunities for housing and jobs through their internal institutions, informal ethnic economy, and culturally familiar urban forms. Being an ethnic enclave, Seattle's Chinatown created a native authentic home culture in a foreign place to the immigrants, while, at the same time, giving a microscopic view of a foreign culture to the mainstream residents. In the urban center of Seattle, there were two co-existing worlds: the Downtown and the Chinatown. Although the separation of both was the focus of spatial policies in early times and the main selling point for tourism market in recent times, the Chinatown has always been a place for the contact and engagement of different ethnic groups.

In Alfred Hitchcock's 1954 movie "Rear Window," the main character, Jeff spent his days and nights watching his neighbors through the rear window of his apartment. The window showed his neighbors' lives as images in a cinema-like view for Jeff. He was the spectator of the film and sat and watched from his chair. Here, Jeff's world co-existed with his neighbors' worlds. Through his window, Jeff stayed in his world while having a limited participation in other worlds by watching. For Jeff, it was not important about what he could see from his window. Rather, it was critical about what he wanted to see, and if he could see what he wanted to see.

As a basic physical spatial element, a window is a divider, defining, separating and linking the inside and outside. Therefore, windows, as a means of spatial element, dissect a space into two different kinds of fragments. It also marks the boundary between the two different spatial fragments. By doing so, windows divide the space users into two different groups, the insiders and the outsiders, according to their physical locations to the window. Windows control the possibility of access. When the windows are closed, the insiders are restricted to be inside while the outsiders stay outside. This paper considers Seattle's Chinatown and its urban forms perform as a "window" to deliver an opportunity of limited participation to both the outsiders from the mainstream society and the residents of the Chinatown.

As discussed above, with the prevailing references of Chinese elements in urban forms in the Chinatown, a strong Chinese imagery was constructed to promote the cultural "difference" and the experience of a "foreign" or "other" place. However, the point of exoticism is not just about having the symbolic forms of Chinese elements. Rather, the sense of exoticism can be only achieved when the Chinese forms are placed into an enclave that are surrounded by non-Chinese forms. That means that only the co-existence of two parallel worlds -- the Chinatown and the outside world -- can create the experience of exoticism. What matters is not the Chinatown is a presence of China; but the Chinatown is a presence of China in American contexts. This suggests that the non-Chinese outsiders and surrounding contexts are equally critical to the exotic forms in the Chinatown. Back to Hitchcock's movie, what interesting was not about Jeff's neighbors' lives, rather it was about how Jeff watched his neighbors and how we watched Jeff that made the movie attractive.

In addition, a window offers the opportunity of limited participation to a different world with convenience and protection. Through windows, users can access to exterior scenic views while still staying in safe & comfortable interior; bank tellers and clients can handle businesses while remaining in their own domains; and game players can explore virtual world while still being in the real world. The Chinatown provide both the outsiders and the Chinese immigrants with a limited participation in each other's world while staying within their own world -- just like Jeff was watching his neighbors from his chair.

The Chinatown acts as a magnet for Chinese foods, gadgets, clothing, souvenirs, arts, and life patterns, offering various opportunities of affordable recreation, shopping, and entertainment that anyone can develop a limited participation into Chinese culture without shifting their own cultural practices. In the meantime, the Chinatown serves as a safe haven and home for Chinese immigrants to develop their skills, confidences, and wealth that enable them to interact with the outside world. That means the Chinatown prepares Chinese immigrants to be Americans while allowing them to maintain the Chinese cultural practices and identity.

There are four layers of windows played by the Chinatown:

1. The Chinatown and its urban forms become the window for outside tourists and visitors who seek exotic experience of Chinese culture. Through street signs in Chinese characters, the Chinatown Gate, and ethnic elements of Chinese architecture inside and outside stores and restaurants, they can have an interesting cultural exploration by experiencing certain Chinese cultural products without traveling to Asia.
2. For Chinese immigrants, the Chinatown serve as the home in a foreign land, offering safety and security and supporting the transition to a new place. In addition to allow the immigrants to identify and access key resources from the inside, the Chinatown also is the window through which the immigrants start to taste American culture and life outside of the Chinatown while knowing there is a cocoon of comfort base to back their explorations.

The Chong Wa Benevolent Association Building (Figure 3) at the corner of the 7th Avenue and the Weller Street built in 1930 is an example of introducing the dominant Western elements into the Chinatown. As the headquarter of a major community organization, this building's main façade was featured with a careful combination of a large pediment in the style of Chinoiserie, an Americanized Chinese design style originated from San Francisco, with classic Western Romanesque style. The unique pediment resembled the side wall of traditional houses in southern China, but pediments were not commonly used in traditional buildings in China. The Chinese elements were visually noticeable, such as decorations at the upturned end blocks at the eaves of the roof on each side and the entrance pediment decorations. However, the brick masonry exterior wall and the keystones and round arches for the windows also suggested a strong western presence. The marriage of visual elements from China and the West presented by the building façade demonstrated a more actively and institutionally conscious approach towards a more cosmopolitan identity. As the building façade clearly indicated, life and culture in the Chinatown was neither Chinese, nor the West, but was caught in between.

3. For the visitors from China, the Chinatown represents a place of cultural anomaly and distortion. In spite of the constructed “Chinese imagery,” the Chinatown is still a neighborhood in a foreign setting, which demonstrates how the native Chinese culture is manipulated to be combined with American cultures. Therefore, the Chinatown presents a different kind of “foreign” or “other” to the Chinese visitors who are interested in exploring the marriage of Chinese culture and its American contexts. In the Chinatown, there are many buildings that present the ethnic Chinese architectural elements in unusual ways or combine Chinese elements with other non-Chinese elements.

An interesting example is the Golden Hong Market building on the 7th Avenue right beside the Chong Wa Benevolent Association Building. This building’s front façade is featured with a layer of Chinese wooden ornaments and three sections of decorative Chinese traditional curved roofs. Unlike their counterparts in China where traditional facades always associated with traditional store signs, this store employs signs in circular shapes with photos and English characters, and banner signs in bright colors, usually found in typical retail stores in the US. As the building façade clearly indicated, life and culture in the Chinatown was neither Chinese, nor the West, but was caught in between.



Figure 3: The opening of the Chong Wa Benevolent Association Building in 1929 (University of Washington Library Special Collections 1929).

4. Finally, the Chinatown is becoming a colorful icon of multiculturalism for Seattle when its unique ethnic architectural forms make it stand out from the surrounding mainstream contexts, when its streets are filled with numerous non-Chinese tourists and visitors, when it continues serving as the “entrance point” for new immigrants, and when it allows fleeting patterns of authentic Chinese culture to be reinterpreted and represented. That means the Chinatown is the window through which Seattle uses as a “performative repertoire of cultural displays” (Lin, 1998) to brand the city to the entire world.

4. CONCLUSION

Over a century, Seattle’s Chinatown has witnessed the tremendous changes of the city center from a very close distance while retaining unique spatial forms for its unique ethnic identity. No matter how the Chinatown responds to socioeconomic changes over the years, the ethnic “Chinese elements” has always been a key theme for most of its culture-based urban forms. They have been always negotiated and reconstructed, despite of the tension between different approaches and forces, to correspond with emerging patterns and to embody in the process of seeking and

retaining a place identity. There are two fundamental questions that had haunted the community for a long time: 1. Who are “we”? and 2. Are “we” “others”?

In the early time of the Chinatown, the culture-based forms were strongly associated with the concept of an “ethnic enclave” that excluded Chinese Americans socially, economically and culturally from the surrounding urban contexts. Living in the ethnic enclave enabled the immigrant community to employ various culture-based urban forms based on their home cultural traditions and heritages as an effective means to shape the shared identities responding to changing contexts. Being key resources of identity development, the culture-based urban forms produced a “counter-mainstream” cultural value internalized by the community to negotiate power relations in the city.

The arguments of how Seattle’s Chinatown should develop its culture-based urban forms since the 1950s have demonstrated the Chinatown’s dilemma of seeking a new identity that can well connect the Chinatown’s unique past, present and future in the wake of urban tourism and global changes. The attempts of promoting exorcism have brought various kinds of urban forms that still facilitate the enhancement of an ethnic enclave. Although the physical and social isolations were gradually lifted after WWII and multiculturalism became highly appreciated in the city, the Chinatown is still deeply entrenched in the image of cultural stereotype that has been prescribed by outsiders. Therefore, the culture-based urban forms there are still struggling in a system of entrenched relationship with the ethnic roots of Chinese culture from the past.

REFERENCES

- Espinoza-Kulick, Mario Alberto Viveros, Maura Fennelly, Kevin Beck, and Ernesto Castaneda. 2021. "Ethnic Enclaves." In *Oxford Bibliographies*, by L. Spillman. New York: Oxford University Press. doi:DOI: 10.1093/OBO/9780199756384-025.
- Khan, Sonia. 2015. "'Otherness' of Ethnic Enclave Attractions in Multicultural Cities: A Study of Chinatowns and Little India." *Asia-Pacific Journal of Innovation in Hospitality and Tourism* 4 (1): 63-76.
- Klein, Nicholas, and Andrew Zitcer. 2013. "Everything but the Chickens: Cultural Authenticity Onboard the Chinatown Bus." *Urban Geography* 46-63.
- Kwong, Peter. 1988. *The New Chinatown*. New York: Hill & Wang.
- Lazear, Edward. 1999. "Culture and Language." *Journal of Political Economy* 107 (S6): 95-126.
- Lin, Jan. 1998. *Reconstructing Chinatown: Ethnic Enclave, Global Change*. Minneapolis, MN: University of Minnesota Press.
- Marcuse, Peter. 1997. "The Enclave, the Citadel, and the Ghetto: What Has Changed in the Post-Fordist U.S. City." *Urban Affairs Review* 33 (2).
- Nguyen, Van. 2011. "Chinatown: The Neoliberal Remaking of Culture in the Contemporary City." *Advocates' Forum* 25-31. https://crownschool.uchicago.edu/sites/default/files/uploads/AdvocatesForum_2011_web.pdf.
- University of Washington Library Special Collections. 1929. *Group posing in front of the Chong Wa Benevolent Association building*. Retrieved from University of Washington Library: <https://digitalcollections.lib.washington.edu/digital/collection/imlswingluke/id/49/rec/2>
- University of Washington Library Special Collections. 1934. *Washington Street Looking East, Seattle, 1934*. Retrieved from Museum of History & Industry: <https://digitalcollections.lib.washington.edu/digital/collection/imlsmohai/id/4082/rec/102>

Exploring Health Equity and the Built Environment through the Social Determinants of Health

Traci Rose Rider¹, Victoria A. Lanteigne¹, J. Aaron Hipp¹, Kia E. Baker², Rosa McDonald¹

¹North Carolina State University, Raleigh, NC

²Baker Ingenuity Group, Knightdale, NC

ABSTRACT: As COVID-19 disproportionately impacted the world's most vulnerable populations, health equity programs burgeoned across disciplines, including public health, business, and architecture. To inform such initiatives, the relationship between health equity and the built environment must be more closely explored. This research examines the relationship between health equity and the built environment through a 3-year study funded by the Robert Wood Johnson Interdisciplinary Research Leaders Program. The study aims to answer the research question: How does the unique designed environment of a hybrid YMCA/elementary school impact the mental and physical wellness of students, families, staff, and the greater community? Findings can inform health equity as the school facility, designed through a highly community-centered process, seeks to support the under-resourced population of Southeast Raleigh, North Carolina, that is often overlooked by design initiatives. Using the Social Determinants of Health as a guiding framework, this study explores the impact of design across the five areas of (1) *economic stability*, (2) *education access and quality*, (3) *health care access and quality*, (4) *social and community context*, and (5) *neighborhood and built environment*. Preliminary findings from surveys address the following discussion points: What are ways in which design can impact health equity? What are the current barriers to health equity that can be impacted by design? And what opportunities exist to increase health equity through design?

KEYWORDS: Health Equity, Social Determinants of Health, Neighborhood and Built Environment, Equity

INTRODUCTION

Connections between the built environment and public health are now widely recognized by policymakers, building professionals, and public health officials. As an example, the Social Determinants of Health (SDOH) include “*neighborhood and built environment*” among five key indicators that affect human health and quality of life (ODPHO n.d.). The disproportionate impact of COVID-19 on vulnerable populations has shed a glaring light on existing health inequities across the world (Raza et al. 2021). Scholars, industry leaders, and policymakers are beginning to look more closely at the built environment's role in advancing health equity (Fedorowicz et al. 2020; Frumkin 2005). This research seeks to forward the conversation on health equity by exploring the design of the built environment using the Social Determinants of Health (SDOH) as a guiding framework. Under a 3-year study funded by the Robert Wood Johnson Interdisciplinary Research Leaders Program, the project seeks to understand how the design of a hybrid elementary school/YMCA located in an under-resourced area of Southeast Raleigh, North Carolina impacts the physical and mental health of a community. Preliminary findings of survey research with school staff address the following questions: 1) What are ways in which design can impact health equity? 2) What are the current barriers to health equity that can be impacted by design? And 3) What opportunities exist to increase health equity through design? Intended audiences for this study include public health and architecture researchers, policymakers, and industry professionals who seek to impact health equity through design.

1.0 BACKGROUND

Researchers and public health experts have long sought to address systemic health inequities facing Black, Indigenous, and People of Color (BIPOC), low-income households, and people with disabilities, among other vulnerable populations. Initiatives promoting health equity strive to ensure that everyone has “a fair and just opportunity to be as healthy as possible” (Braveman et al. 2012). As connections between public health outcomes and the built environment continue to emerge, emphasis is being placed on the built environment's role in impacting health equity (Frumkin 2021). Addressing health equity includes the active removal of barriers that may exist in programs, policies, and environments that impact one's ability to be as healthy as possible (Brooks-LaSure et al. 2021). In the context of the built environment, which can be defined as human-made places where occupants live, work, learn, acquire services, and recreate on a daily basis (Roof & Oleru 2008), some such known barriers to health include lack of natural light, poor indoor air quality, and sedentary design.

The built environment influences aspects across all five Social Determinants of Health – (1) *economic stability*, (2) *education access and quality*, (3) *health care access and quality*, (4) *social and community context*, and (5) *neighborhood and built environment*. Understanding how population groups “experience ‘place’ and the impact of ‘place’ on” health is fundamental to understanding the Social Determinants of Health, including both social and physical determinants (ODPHP n.d.). However, design remains relatively unexplored as a strategy for eliminating health disparities. There is a significant opportunity to deepen our understanding of strategies that promote health equity in the context of *neighborhood and built environment*. As an example, less than half of the recommended interventions for addressing *neighborhood and built environment* include design-specific strategies (DHHS n.d.b). Emerging research further underscores this gap by identifying health equity interventions in the form of financing, urban planning, and programming, with little emphasis on design (Fedorowicz et al. 2020). More research is needed to explore how the SDOH can be operationalized through built environments designed to support specialized social initiatives, through both physical form and programming.

1.0 METHODOLOGY

2.1. Study Design

This larger project adopts a case study methodology (Yin 2006) to explore physical and mental health outcomes connected with the built environment by conducting occupant surveys, in-person interviews, building assessments, and community canvassing. The case school selected through purposive sampling is an academic facility co-located with a YMCA in Southeast Raleigh, North Carolina, an area identified as having “high opportunity for positive change” (NCIPH 2018). The project was designed through a highly community-centered approach, which included school administrators, a community-based advocacy organization, directors from the YMCA of the Triangle, and members of the Wake County Public School System. The integrative process critically elevated the needs of a community that is 90% non-white, with 56% of households earning less than \$40,000/year and only 21% of adults having a college education. The case school opened in August 2019 but closed within months of operation due to the COVID-19 pandemic. After reopening in March 2020, the facility is in the process of welcoming its first cohorts of students, growing YMCA membership, and establishing robust afterschool and summer programs. To strengthen findings, the research team selected a matched elementary school serving the same surrounding census tracts in Southeast Raleigh. The study applies a health equity lens using the Social Determinants of Health (SDOH) as a guiding framework to understand how conditions in the environment affect health, functioning, and quality-of-life outcomes and risks. This paper focuses on findings from participant surveys to understand how the design of a school in this community context can uplift health equity.

2.2. Data Collection

An online, anonymous survey was created in Qualtrics and distributed to the staff, administrators, and faculty at both the case and matched schools in the spring and summer of 2021. Given the stresses of COVID-19, the school administration distributed the survey to all staff between March – August 2021, along with several reminders. The survey instrument included a mix of open and close-ended questions that were developed using the SDOH as guiding categories. Each SDOH “module” in the survey had approximately 3-5 close-ended questions using a Likert scale that aimed to operationalize aspects of health equity in the context of the school environments; the exception was the *neighborhood and built environment* module which contained 10-15 close-ended questions about participant experiences and usage of the indoor and outdoor environments at their school. Summarizing each module was an open-ended question allowing participants to share additional experiences regarding connections between the built environment and their physical, mental, and emotional health. Participants who indicated that they were at the case school were routed to an additional module that more deeply explored “healthy building” strategies specific to the case school. Data gleaned from this additional module will be used in future research to further operationalize *neighborhood and built environment* as a SDOH. The survey instrument was approved by the university IRB and distributed to all participants by email through each school’s administration. Surveys were non-mandatory; however, participants were offered an opportunity to provide their email address to enter a drawing for one of six gift cards per school.

A total of 48 surveys were received – 29 were completed from the case school and 19 were completed from the matched school. Among the 48 survey respondents, most were between the ages of 26-35 and 46-55 (66%); most identified as a woman (91%), and most identified as Black or African American (52%). See Figure 1 for complete participant demographic information; note that some participants did not respond to all demographic questions. Given the exploratory nature of this study, the findings cannot be generalized. The goal of this research is to explore possible relationships to be further studied. Even then, findings would be potentially transferrable to similar communities and projects, not generalizable.

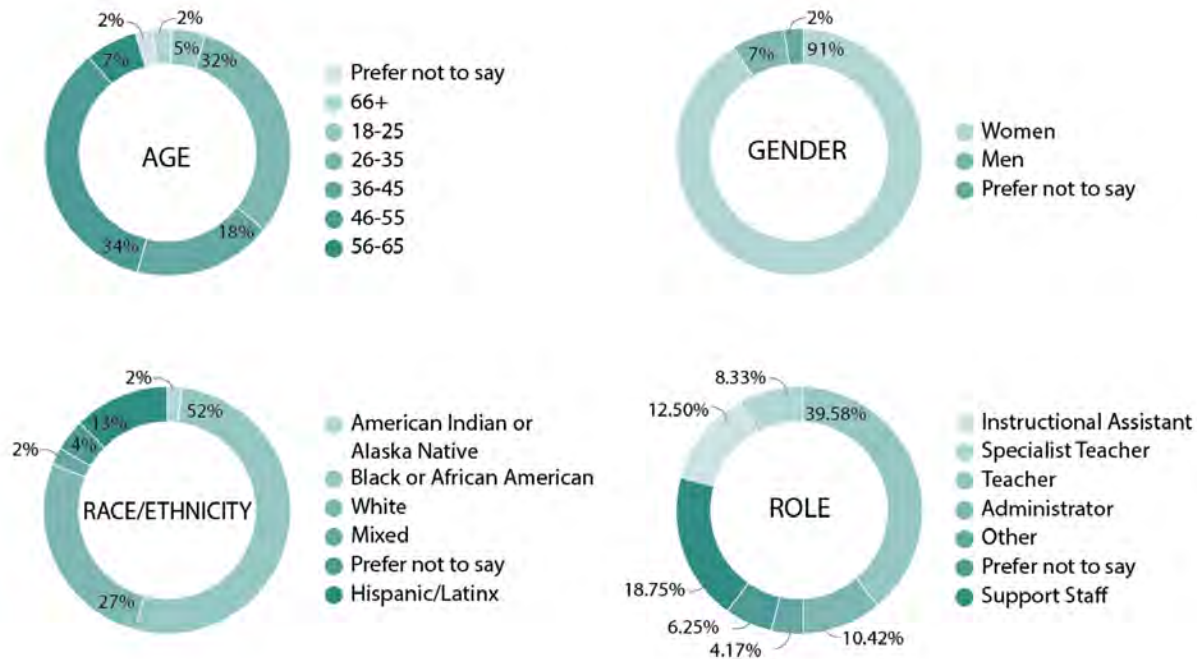

Figure 1: Participant demographics from survey results. Source: (Authors 2021)

2.0 RESULTS AND ANALYSIS

The findings from survey research across each of the SDOH are presented below.

3.1. Education Access and Quality

There are a myriad of ways that access to quality education can positively impact health and wellbeing over the life course (Hahn and Truman 2015). While access to quality education is beyond the scope of a single site or a single building, and somewhat inherent in these selected projects because they are educational buildings, some questions were included in the survey to align with the SDOH pillar of *education access and quality*. These questions minimally address how the building might increase active engagement and student learning in design. However, because these are educational facilities within the same larger school administration system, it was anticipated that the responses would be similar.

In comparing learning and educational development across the case school and matched school, participants from both populations were asked about the active engagement of their students in the learning curriculum, learning activities, and organized school activities. The matched school outperformed the case school in each of these categories. The absolute difference of participants that either agreed or strongly agreed was in favor of the matched school in learning curriculum by 15%, by 22% in learning activities, and by 30% in organized school activities. When specifically addressing issues of diversity and inclusion, participants were asked if they felt their school promoted diversity, inclusion, and a sense of belonging. The participants from each school equally somewhat or strongly agreed that their school promotes diversity at 74% and were still generally in agreement about the promotion of inclusion in the school (74% at the case school and 63% at the match school). The perception on promoting a sense of belonging, however, was somewhat different with participants at the case school indicating 70% agreement while only 44% of the match school agreed (Figure 2).

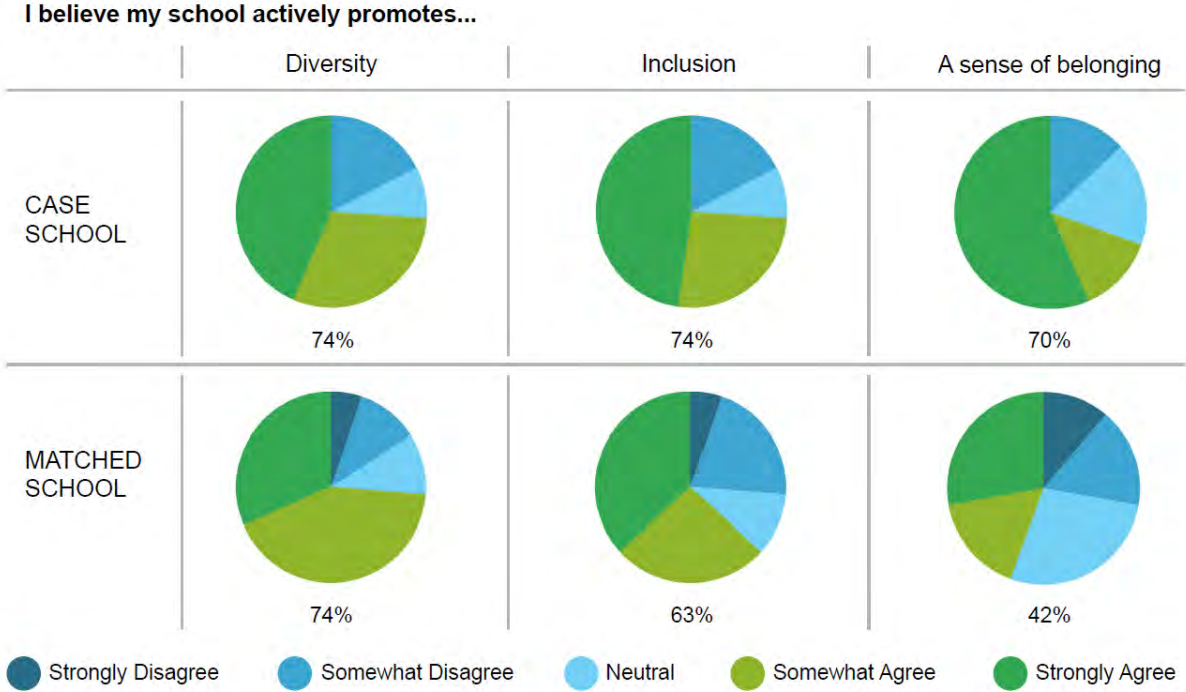

Figure 2: Survey results for SDOH questions on Education Access and Quality. Source: (Authors 2021)

3.2. Social Connection and Community Engagement

The SDOH category of *social and community context* was addressed next. Social and community contexts are extremely important, likely impacting individual health and healthy behaviors. As such, these questions addressed issues around family engagement and connection to community, and how the school contributes to social connection and community engagement. The intent was to better understand how the school and its supported programming can play an active role in community cohesion.

The survey asked about perceptions of community engagement. While the matched school indicated more active engagement of families (74% v 52% for the case school), the case school outperformed the matched school in terms of perception of their schools’ engagement with the community, their feeling connected to the community, and perception of the community feeling connected to their school (Figure 3). There was at least a 30% absolute difference in these responses, with an absolute difference of 41% on the question addressing how connected the community felt to the school. While the sample sizes were too small to indicate statistical significance, this is a notable difference.

When asked in an open-ended question about other ways in which the school contributes to social connection and community engagement, if at all, the case school respondents listed considerably more unique opportunities. While both schools had responses around standard communications, texts and apps for communication with parents, school websites, and food distribution, the case school also mentioned additional community connections such as providing targeted and individual family assistance; food drives; farmers markets; YMCA events; staff participation in YMCA activities; community partnerships; interpreters; family nights; popsicles in the park; and movie nights. While the matched school responses also included elements such as access to the playground and free library books for community, they also included negative feedback such as uncertainty around whether efforts fit community need and staff not bought in/ overburdened already.

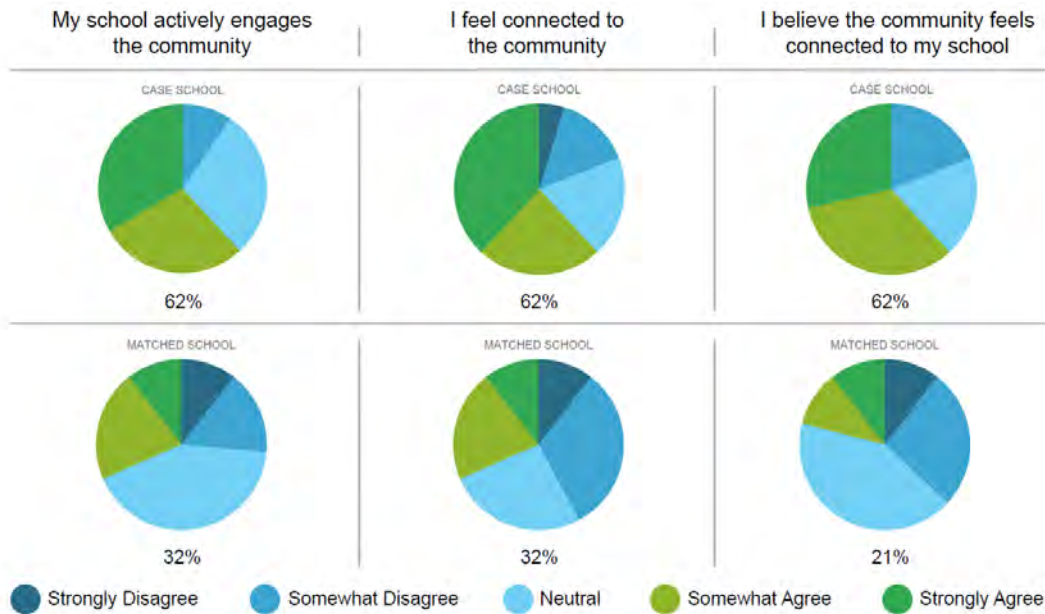

Figure 3: Survey results for SDOH questions on Social and Community Context. Source: (Authors 2021)

3.3. Physical and Mental Health

The SDOH category *health care access and quality* addresses broad aspects of health including primary care visits, programmatic interventions, and individualized health agendas (DHHS n.d.a). For the purposes of this study, this determinant has been distilled as aspects of physical and mental health that are impacted by the built environment.

Findings from the survey showed that participants from the case school felt more supported across aspects of physical, mental, and emotional health. Specifically, when asked about how their school promoted physical activity in support of physical health, responses from the case school were 13% higher than the matched school (74% to 61%). Regarding mental health, when asked about how their school supported mental and social and emotional health, the deltas of those that somewhat or strongly agreed were higher percentages from the case school, at 29% (mental health) and 28% (social and emotional health) respectively (Figure 4). However, when asked about support programs such as student counseling, psychological services, and social services, the matched school responses showed a slightly higher percentage (79% case school v 89% matched school). Similar absolute differences were seen in psychological services (58% case school v 67% matched school). It is suspected this slim margin is likely due to systemic measures implemented by the schools to increase student services to support physical, mental, and emotional health based on the individual student populations and needs.

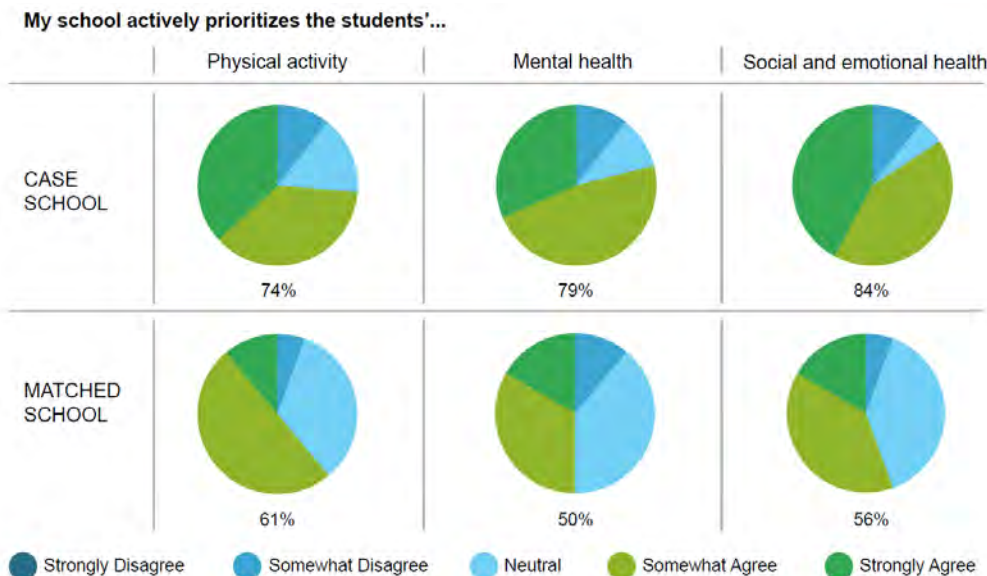

Figure 4: Survey results for SDOH questions on Physical and Mental Health. Source: (Authors 2021)

3.4. Economic Security

While difficult to address through built environment strategies, *economic security* is an important pillar of the SDOH framework. Therefore, the survey addressed these concerns through the lens of overall support to mitigate additional stressors. When asked about school support pre-COVID, participants were asked about their views on employee development, general employee happiness, their ability to conduct work safely, and their ability to work from home as needed - both pre-COVID and after reopening. Pre-COVID, the case school participants' agreement was larger than those participants at the matched school in terms of general employee happiness (44% absolute difference), employee development (36% absolute difference), and the ability to conduct their work safely (23% absolute difference). The matched school, on the other hand, outperformed the case school in the ability to work from home as needed (30% absolute difference).

The same issues were given to address reopening. The general trends were the same, though with slimmer absolute differences. The case school participants' agreement was larger than those participants at the matched school again in terms of general employee happiness (37% absolute difference), employee development (9% absolute difference), and the ability to conduct their work safely (14% absolute difference). The matched school, again, outperformed the case school in the ability to work from home as needed (11% absolute difference) (Figure 5). When asked about other ways in which the schools may have contributed to economic stability beyond salaries, the case school participants had little to share. One noted that they lived close by so could save on gas. Another shared that there were none. The matched school, however, shared the ability to work from home, and administrative emails about benefits such as vaccines, loans, and job fairs.



Figure 5: Survey results for SDOH questions on Economic Stability. Source: (Authors 2021)

3.5. Neighborhood and Built Environment

Previous research has readily associated the built environment with both physical activity behaviors and health outcomes such as obesity, cardiovascular disease, diabetes, and cancers (Sallis et al. 2012). This survey aimed to understand how participants' physical, mental, and emotional health might be impacted by the interior environment and surrounding site elements at their schools. To assess interior spaces, participants were asked whether they felt they had access to clean air, natural elements, natural daylight, quiet spaces, spaces that promote physical activity, spaces that promote mental health and wellness, quality lighting, pleasant views, and pleasant colors. Case school participants that agreed or strongly agreed were approximately 30% higher than the participants in agreement from the matched school when asking about natural elements, natural daylight, pleasant views, and pleasant colors. The percentages of agree or strongly agree remained approximately 20% higher than the matched school when asking about spaces promoting physical activity, promoting mental health and wellness, and having quality lighting. The absolute difference in percentages addressing quiet spaces was smaller, with the case school outperforming the matched school by a slim 5%. Clean air was the only aspect in which the matched school performed higher satisfaction, recording an agreement of a 7% absolute difference higher than the case school (Figure 6). This shift is not surprising, particularly after an airborne pandemic. The case school was not built with operable windows while the matched school, designed and constructed about 10 years prior and under different system standards, does have operable windows. The pandemic has placed fresh air and operable windows at the front of the minds of those teachers in static classrooms.

When I am inside my school, I feel I have access to...



Figure 6: Survey results for SDOH questions on Neighborhood and Built Environment. Source: (Authors 2021)

3.0 DISCUSSION

This study aims to address significant questions around advancing health equity in under-resourced neighborhoods including: 1) What are ways in which design can impact health equity; 2) What are the current barriers to health equity that can be impacted by design; and 3) What opportunities exist to increase health equity through design? Key themes that emerged during data analysis help to address these questions, with a specific focus on understanding how the built environment can begin to impact each SDOH category. For the case school, it is possible that the built environment had an increased beneficial impact on learning and educational development by facilitating a sense of belonging and supported social connection by providing programming and collaborative spaces that foster community engagement. Furthermore, clear direction for design strategies can be gleaned based on participants agreeing/strongly agreeing with survey responses that emphasized health-promoting design features around clean air, natural elements, natural daylight, quiet spaces, spaces that promote physical activity, spaces that promote mental health and wellness, quality lighting, pleasant views, and pleasant colors. Barriers to health equity in the built environment can be presumed as the converse; environments that fail to promote a sense of belonging, community engagement, and health-promoting design features challenge the ability to support equity. Instances where educational facilities miss opportunities to address health-promoting indicators will provide less opportunities for students, staff, and the community to achieve health equity. Opportunities exist to continue to explore health equity in the context of the built environment, including the future operationalization of design strategies that promote physical, mental, and emotional health. One future goal of this study is to distill design recommendations promoting physical, mental, and emotional health across K-12 schools.

CONCLUSION

While future research is undoubtedly needed, this study is an important step in exploring the connection between design and the built environment through a health equity lens using the Social Determinants of Health as a framework. Through case study research on a hybrid YMCA / elementary school located in Southeast Raleigh, North Carolina, the project has identified clear connections between design and health. In the context of health equity, key themes that emerged in findings from the case school surveys - a sense of belonging, community connection, and health-promoting design features - warrant further exploration. Subsequent phases of this research study including qualitative interviews, community-based focus groups, and on-site building observations will continue to apply a health equity lens to understand how design impacts the physical, mental, and emotional health of an underserved community.

REFERENCES

- Braveman, P., Arkin, E., Orleans, T., Proctor, D, Plough, A. 2012. *What is Health Equity? And What Difference Does a Definition Make?* Robert Wood Johnson Foundation.
- Brooks-LaSure, C., Boozang, P., O'Connor, K, Reginal, A. 2021. *State Strategies for Overcoming Barriers to Advance Health Equity*. State Health and Value Strategies (SHVS) and Manatt Health. <https://www.shvs.org/wp-content/uploads/2020/11/State-Strategies-for-Overcoming-Barriers-to-Advance-Health-Equity.pdf>
- Fedorowicz, M., Schilling, J., Bramhall, E., Bieretz, B., Su, Y., Brown, S. 2020. *Leveraging the Built Environment for Health Equity: Promising Interventions for Small and Medium-Size Cities*. Urban Institute.
- Frumkin, H. 2021. "COVID-19, the built environment, and health." *Environmental health perspectives* 129, no.7. doi.org/10.1289/EHP8888
- Frumkin, H. 2005. "Health, Equity, and the Built Environment." *Environ Health Perspect* 113, no. 5: doi.org/10.1289/ehp.113-a290.
- Hahn, R. A., & Truman, B. I. 2015. "Education Improves Public Health and Promotes Health Equity." *International Journal of Health Services: Planning, Administration, Evaluation* 45, no.4: 657–678. doi.org/10.1177/0020731415585986.
- North Carolina Institute for Public Health (NCIPH). 2018. *Exploring the Social Determinants of Health in Wake County*. University of North Carolina. https://nmcn.io/e186d21f8c7946a19faed23c3da2f0da/3927fe5842374f31bc0cca5ce1cec22a/files/learning/mapping-social-determinants-of-health-in-wake-county-the-link-and-user-guide/Exploring_SDOH_in_Wake_County_JRE.pdf.
- Office of Disease Prevention and Health Promotion (ODPHP). n.d. "What are Social Determinants of Health?" *Healthy People 2030, U.S. Department of Health and Human Services*. <https://health.gov/healthypeople/objectives-and-data/social-determinants-health>.
- Raza, R., Williams, J. L., and McTarnaghan, S. 2021. *Emerging Lessons from the COVID-19 Pandemic for Building Urban Health Equity. Impact on Urban Health*. Urban Institute, 1-20. https://www.urban.org/sites/default/files/publication/104126/emerging-lessons-from-the-covid-19-pandemic-for-building-urban-health-equity_0.pdf.
- Roof K. and Oleru, N. 2008. "Public Health: Seattle and King County's Push for the Built Environment." *J Environ Health*, 71, no. 1 (July – Aug):24-7.
- Sallis J. F., Floyd M. F., Rodriguez D. A., Saelens, B. E. 2012. "Role of Built Environments in Physical Activity, Obesity, and Cardiovascular Disease." *Circulation* 125, no. 5:729-37. doi: 10.1161/CIRCULATIONAHA.110.969022.
- U.S. Department of Health and Human Services (DHHS). n.d.a "Access to Health Services." <https://www.healthypeople.gov/2020/topics-objectives/topic/social-determinants-health/interventions-resources/access-to-health>
- U.S. Department of Health and Human Services (DHHS). n.d.b. "Neighborhood and Built Environment." <https://health.gov/healthypeople/objectives-and-data/browse-objectives/neighborhood-and-built-environment>
- Yin, R. 2006. *Case Study Research: Design and Methods*. Thousand Oaks, London: Sage Publications.

Creating a Building for the Purpose of Helping Youths: An Instrumental Qualitative Case Study

Nima Daniel Meghdari¹

¹University of Minnesota, Minneapolis, MN

ABSTRACT: Physical environments influence behavior and development. This concept has been thoroughly investigated regarding the design of healthcare and educational settings. In comparison, secure rehabilitative settings, such as juvenile treatment facilities, have been the focus of minimal theoretical and empirical research. To address this research gap, this investigation utilized an instrumental qualitative case study approach to examine the architecture and design considerations of a secure juvenile treatment facility located in the upper Midwest of the United States. Supported by advisors from the primary investigator's university of study and the case site's architecture firm of record, this research project utilized facility design documents, archival records, and one-on-one interviews with key stakeholders responsible for directly influencing the case site's design to develop an adaptation of the Trauma-informed Design model. Materials generated from this research project are intended to inform design professionals and researchers, juvenile justice practitioners, and policymakers regarding the design of secure juvenile treatment facilities.

KEYWORDS: architecture, behavioral health, environmental psychology, secure juvenile treatment facilities, trauma-informed design

1.0 INTRODUCTION

Through sensory processes, perception, and cognition, the built environment can influence occupant attitudes and behaviors (Mazumdar, 2000). The influence of the built environment on occupant behaviors has been widely investigated in both educational and healthcare settings (e.g., Andrade et al., 2017; Bower et al., 2019; Liempd et al., 2020; Peditto et al., 2020; Ulrich et al., 2018). Comparatively, settings dedicated to treating individuals with violent and disruptive behaviors (e.g., corrections facilities) have received little attention (Ulrich, 2019), and research has primarily focused on developing treatment methods (e.g., Olafson et al., 2016). To expand upon this body of knowledge, this research project examines the design of a secure juvenile treatment facility to develop a conceptual framework intended to inform the future research and design of this facility type.

1.1 Background

On any given day in the United States, approximately 55,000 youths are held in juvenile custody -- nearly 85% are held in juvenile facilities (Office of Juvenile Justice and Delinquency Prevention, 2019). Juvenile justice reforms of the 21st century have resulted in public policies focused on reducing the population of confined youths. Improved screening instruments, the implementation of less intrusive strategies, and the expansion of community-based programs have narrowed entrance into the juvenile justice system so that only youths posing the most significant potential risk to public safety are placed in juvenile facilities (Bernard & Kurlychek, 2010; Snyder & Sickmund, 2006). Consequently, youths who enter and remain in juvenile facilities present the most significant risk of violence and represent those most in need of rehabilitative treatment. Because the number of youths housed in juvenile facilities is a critical variable in determining facility funding, the success of population reducing policies (reductions of up to 60% in some states) has simultaneously and unintentionally reduced the availability of resources needed to treat youths most in need of care (Office of Juvenile Justice and Delinquency Prevention, 2019; Snyder & Sickmund, 2006).

1.2 Population Overview

Data collected by the Office of Juvenile Justice and Delinquency Prevention (2019) revealed that nearly nine out of every ten (85%) youths held in juvenile facilities were male. Additionally, more than two-thirds (69%) of the youths housed in these facilities were 16 years of age or older. The Office of Juvenile Justice and Delinquency Prevention (2019) also identified that minority youths represented over half of all youths detained by the United States juvenile justice system. Relative to their population percentage, African American and American Indian youths were overrepresented in the juvenile justice system (Nicholson-Crotty et al., 2009; Office of Juvenile Justice and Delinquency Prevention, 2019). Although only 14% of all youths under the age of 18 in the United States were African American, 42% of males and 35% of females in juvenile facilities were African American. Similarly, American Indian youths, despite comprising less than 1% of all youths in the United States, constituted 1.5% of males and 3% of females in juvenile facilities (Office of Juvenile Justice and Delinquency Prevention, 2019).

1.3 Mental Illness and Trauma

Trauma and mental illness are prevalent among juvenile facilities' youth population (Ford et al., 2008; Whitley & Rozel, 2016). Work done by Abram et al. (2004) found that over 90% of youths in juvenile facilities had experienced at least one traumatic event, and over half (56.8%) had experienced six or more traumatic events. Furthermore, common diagnoses for youths in juvenile facilities include behavior disorders, substance use disorders, anxiety disorders, attention deficit disorders, and mood disorders (Chassin, 2008; Shufelt & Cocozza, 2006; Whitley & Rozel, 2016). A systematic review conducted by Fazel and Langstrom (2009) found that youths in detention facilities were ten times more likely to suffer from psychosis compared to youths in the general population. Additionally, work by Schubert et al. (2014) determined that roughly two-thirds of youths in juvenile facilities suffered from at least one mental disorder (e.g., depression or dysthymia). Research has also shown that incarcerated youths are more likely to possess characteristics commonly associated with an increased risk of suicide (Hayes, 2004), such as high rates of psychiatric disorders, mental illnesses (Kemp et al., 2020; Teplin et al., 2002), and trauma (Abram et al., 2004; Shelton, 2000). The Centers for Disease Control and Prevention (2013) identified suicide as the third-leading cause of death for youths between the ages of 15 and 24. Conditions associated with confinement, such as sleeping in locked rooms (Gallagher & Dobrin, 2005; 2006) and solitary confinement (Marcus & Alcabes, 1993), have been found to increase the risk for suicide among detained youths. The prevalence rates of completed suicides for incarcerated youths are roughly four times higher than youths in the general population (Gallagher & Dobrin, 2006), and prevalence rates of self-harm and suicidal ideation in the incarcerated youth population have been found to be as high as 51% (Cauffman, 2004; Goldstein et al., 2003; Kemp et al., 2020; Shelton, 2000).

1.4 Stress, Aggression, and the Physical Environment

Recognizing the interconnected relationship between environments and individuals requires an understanding of stress. Stress is an outcome of the interactions between environments and individuals and is conceptualized as a collection of physical and psychological changes that occur in response to perceived challenges and threats (Mulligan & Neistadt, 2003). There is consensus in environmental psychology research that the physical environment of an individual's living space strongly and directly influences occupant stress (Ulrich, 2019). Facility designs that do not address crowding, noise, and other stressful features have been found to exacerbate occupant stress during confinement, thus provoking aggressive behavior and degrading treatment outcomes (Ulrich, 2019). The idea that stress can act as a trigger for aggression and other negative behaviors is commonly reflected in explanatory models of aggressive behavior (Ulrich, 2019). Psychiatric models such as those developed by Kumar & Ng (2001) and Nijman (2002) have included the physical environment as a variable in influencing stress, with the premise that poorly designed physical environments can exacerbate stressful events. Work by Sariaslan et al. (2016) found that exposure to major stressors significantly increased the risk of aggressive behavior for individuals with a history of mental illness.

1.5 Trauma-Informed Design Model

The connection between an individual's immediate physical environment and behavior has been explored through various systems-based theories. In this fashion, work by Andrade et al. (2017), Bower et al. (2019), and Peditto et al. (2020) found that the physical design of hospital rooms influenced occupant stress levels and the effectiveness of patient treatment. Similarly, Liempd et al. (2020) determined that youth behavior and development were significantly affected by school classroom design. The use of such theories in educational and healthcare settings supports the examination of secure juvenile treatment facilities as they are the immediate physical environment of juvenile youths receiving treatment via the U.S. juvenile justice system. However, a common limitation of system-based theories is that although they provide a framework for understanding how the built environment affects human behavior, they do little to provide measurable constructs (Darling, 2007). This limitation was remedied for this research project by utilizing the Trauma-informed Design (TID) model to identify and classify environmental influencers of youth behavior.

The TID model is best described as a derivative of the human service field's Trauma-informed Care model (Gerber, 2019). The Trauma-informed Care model acknowledges the importance of understanding trauma's role in influencing an individual's life and focuses on providing care that reduces stress and the risk of re-traumatization (Gerber, 2019). The TID model takes constructs identified in the Trauma-informed Care model and uses them to create broad environmental guidelines intended to facilitate occupant treatment by reducing stress (Gerber, 2019). Constructs of the TID model as defined by the Substance Abuse and Mental Health Services Administration (SAMHSA) include safety, choice, collaboration, trustworthiness, and empowerment. The objective of using the TID model is to design and create trauma-informed environments -- physically and emotionally safe environments that allow the establishment of trust, support autonomy and choice, create collaborative relationships, allow for the participation of those being treated, and promote resilience using an empowerment-focused perspective (Gerber, 2019).

2.0 METHODS

This research project utilized a qualitative instrumental case study approach to investigate environmental considerations that influenced the architectural design of a secure juvenile treatment facility located in the upper Midwest of the United States. An initial investigative model based on established TID constructs as defined by SAMHSA (2020) was used. A qualitative methodology was employed due to the research project's inherent need to understand, rather than explain (Creswell & Poth, 2018) the TID model's potential regarding the design of secure juvenile treatment

facilities. Similarly, an instrumental case study approach was employed to broaden the understanding of the issue in its real-life context (Creswell & Poth, 2018; Yin, 2003) and further develop the TID model for designing facilities of this type. This case study approach provided the Primary Investigator (PI) with rich qualitative information (Creswell & Poth, 2018; Yin, 2003) and was facilitated by project advisors that included faculty from the PI's university of study and designers from the case site's Architecture Firm of Record (AFR). Project advisors assisted by sharing their professional knowledge, expertise regarding qualitative research, and constant feedback via bi-weekly meetings held with the PI throughout the research project's conception, development, and dissemination.

2.1 Case Selection

The project's case site (CS) is a recently remodeled but not yet completed, secure juvenile treatment facility located in the upper Midwest of the United States. The CS was selected due to its focus on behavioral health and improving facility accommodations based on its unique occupant needs. The AFR provided the PI with proprietary information in the form of architectural design documents, access to professionals that were part of the project's design team, and access to CS doctors who helped identify and define the facility's programmatic needs. Additionally, the AFR supported the research project by orienting the PI via an initial walkthrough of the design and providing project files such as the AFR's internal office communications concerning the project's design, development, and overall progression.

2.2 Data Collection

To obtain a better understanding of the CS, contextual information was gathered to orient the PI to the field of juvenile justice, treatment, and practice. This research project triangulated findings using multiple data sources, utilized investigator triangulation in its analysis, situated issues within the context of facility design, and allowed flexibility in the investigative research model to incorporate relevant topics and themes as they were identified throughout the research process. Both qualitative and quantitative data were collected to verify and contextualize the research project's findings. Data were gathered from project documents and materials and one-on-one interviews. An investigative research model was used to examine the applicability, relationship, and overall fit of the TID model's constructs of safety, collaboration, trustworthiness, empowerment, and choice. These constructs were examined as they related to the design consideration of a secure juvenile treatment facility, and model adjustments were made to account for the research project's findings (e.g., construct reclassification).

2.2.1 Project Documents and Materials

Project documents and materials for the CS were obtained from the AFR and were used to analyze both existing and proposed project conditions. All documents and records provided by the AFR were purged of all personally identifiable information prior to analysis and destroyed at the research project's conclusion. Due to the immensity (911 individual files) and complexity of the project documents and materials, two staff members from the AFR (i.e., one architect and one interior designer) directly involved with the CS's design process acted as liaisons to the AFR. The AFR liaisons helped orient the PI to the project's design and in-house terminology (i.e., language unique to the design team that would be unrecognizable to non-design team individuals). To avoid bias, the AFR liaisons were instructed to focus on the CS documents and materials' contents and refrain from discussing design processes, reasonings, and considerations during this initial walkthrough.

2.2.2 One-on-one Interviews

The AFR coordinated participant access and facilitated scheduling with the understanding that recruitment was to be restricted to CS doctors and professionals from the AFR that were directly involved with the CS's design. Participant and researcher bias was mitigated by employing best practices for qualitative research. These practices included the use of indirect questions, the use of open-ended questions, maintaining a neutral stance during interactions with participants, avoiding the implication that there was a correct answer, being aware of confirmation bias, the consideration of every response, and the use of outside reviewers (Creswell & Poth, 2018). Two rounds of interviews were conducted via online conference calls (i.e., Zoom®). Interviews were conducted with a total of ten participants – eight professionals that were directly involved with the CS's design (e.g., architects, interior designers, and project team members from the AFR) and two CS doctors. Interviews followed a semi-structured format, lasted roughly one hour, and were automatically transcribed. At the end of each session, the PI wrote a summary of the interview, identifying the participant's key points. Field notes concerning non-verbal communications (e.g., hand gestures, facial expressions, and tonal changes) were taken post-interview via recordings, allowing the PI to focus on facilitating and prompting the discussion during the session.

Each round of interviews was used to develop the investigative research model and inform subsequent data collection and analyses. The first round of interviews included open-ended questions primarily informed by the established TID constructs and the CS's documents and materials. First-round interviews investigated contextual information regarding the design of the CS, probed participants for considerations that influenced the project architecturally, and made inquiries regarding sources of information that were used throughout the project's development. Although a formal script was created, the interview's semi-structured format led to variations in prompts used and the order in which questions were addressed.

The second round of interviews was conducted with the same participants as the first round, except for one participant who could not take part in the second round of interviews. The second round of interviews followed a semi-structured format and was divided into two phases. The goal of the first phase was to verify information already gathered by providing participants with summarized bullet points of information gathered from the first round of interviews. Participants were instructed to evaluate the summary bullets as either being correct, incorrect, or partially correct. If a summary bullet was deemed incorrect or partially correct, the participant was asked to elaborate and explain the missing and/or inaccurate information. The second phase of the interviews focused on investigating themes identified by the first round of interviews and the established TID constructs as defined by SAMHSA (2020). Themes were investigated by inviting participants to define each theme/construct and identify physical features in the CS that embodied these themes. Participants were also instructed to make comments regarding the themes' applicability to the project (i.e., are these ideas relevant to design) and discuss their relationship and similarities to one another.

2.3 Analysis of Project Documents and Materials

Project documents and materials provided by the AFR were analyzed via a comparative study between the existing facility and the new design proposed by the AFR. Varying physical attributes determined relevant by the literature (e.g., room sizes, window counts, and distances to nurses' stations) were investigated, and differences were cataloged and noted descriptively. Project files (e.g., internal office communications between the AFR's design staff and other stakeholders) were used to supplement the comparative findings. Due to the extensive and comprehensive nature of the project's files, these materials were analyzed using abductive reasoning -- this analysis was aimed at identifying overarching themes and trends that could be used to inform first-round interview questions.

2.4 Analysis of One-on-one Interviews

Data obtained from interviews (i.e., interview transcripts and field notes) were prepared for analysis by purging them of all personally identifiable information, removing repeated words, correcting grammatical errors, and organizing them into a comprehensive Microsoft Excel[®] file.

Data from the first round of interviews were analyzed using inductive reasoning. Commonly referred to as a data analysis spiral, inductive reasoning originates with the researcher's exposure and re-exposure to the data until a holistic view is established. In the context of this research project, this took the form of the PI reading and re-reading the interview transcripts. Concurrently, the PI used annotations to highlight and link key concepts and/or phrases found within the data. The next level of the spiral began the "describing, classifying, and interpreting loop" (Creswell & Poth, 2018, p.144) and was initiated by sorting data using coding defined during the analysis process. Such reasoning aims to identify themes and tentative hypotheses that have not been delineated prior to the analysis (Creswell & Poth, 2018). Due to this process's progressive nature, first-round interviews were coded one at a time, with additional coding being added as deemed necessary by the PI. Once all the data from the first-round interviews had been coded, thematic categories were identified and defined. Investigator triangulation was used to validate analysis findings. Faculty advisors from the PI's university of study were provided the raw data from the first round of interviews and conducted independent analyses (personally identifiable information was removed prior to sharing data). Each investigator independently read, interpreted, and coded the data into thematic categories. Lastly, findings from all independent analyses were evaluated for consistency and modified to condense the total number of identified themes.

Contrasting the analysis of first-round interviews, data from the second round of interviews were analyzed using deductive reasoning. Deductive reasoning begins with a pre-established set of themes commonly derived from a guiding model or theory (Creswell & Poth, 2018). Using the established TID model as defined by SAMHSA (2020) and themes identified during the first-round interview analysis, data from the second-round interviews were coded and used to develop an adapted TID model.

3.0 FINDINGS

Although participants varied in their professional backgrounds and involvement concerning the design of the CS, data analysis identified common themes and opinions regarding the facility's environmental considerations. The themes identified during the one-on-one interviews were consistent with participant design perspectives (i.e., their interpretation of the facility's function) and associated design requirements. As a whole, respondents broadly conceptualized the CS as a high-security correctional setting, treatment and rehabilitative setting, and as part of the juvenile justice system's continuum of care. However, it should be noted that although participants frequently referenced environmental considerations that resonated the most with their personal and professional backgrounds, all participants acknowledge the CS as a complex facility requiring an understanding and balance of multiple functions.

3.1 High-security Correctional Setting

When utilizing the design perspective that the CS was a high-security correctional setting, respondents primarily concentrated on safety and security. When discussing safety and/or security, participants frequently paired the two ideas together and often used them interchangeably to illustrate the overarching goals of spaces, environmental features, and design strategies. However, when directly asked if they believed the two were one and the same, participants articulated that they recognized safety and security to be separate yet closely related ideas.

3.1.1 Safety

Participant responses concerning the concept of safety were directed at the environment's ability to minimize the risk of harm for all occupants (i.e., staff, youths, and visitors). When further probed about what it meant to create spaces that minimized the risk of harm, participants gave examples inherent to two avenues of thought. First was the concept of psychological safety, which encompassed environmental features used to reduce the risk of harm to a person's state of mind (e.g., positive aesthetics and imagery); and second was the idea of physical safety, which embodied environmental features used to reduce the risk of damage to a person's body. The latter concept was further delineated as ecological features used to avert injury directed at oneself (e.g., anti-ligature) and features used to prevent harm directed at others.

Participant discussions regarding occupant physical safety commonly referenced environmental features used to separate various youth groups (e.g., separation by gender) and create durable and easily maintained spaces via resilient installations. Consequently, select spaces within the CS (e.g., bedrooms intended to house new facility arrivals) were designed to withstand high levels of intentional and unintentional wear, abuse, and destructive/malicious behavior. Participants discussed the utilization of resilient installations from various perspectives (e.g., cost, durability, and aesthetic appeal) but largely viewed it as necessary to reduce the possibility that youths would use the environment as a tool to harm themselves and/or others (e.g., pica behavior). Similarly, the separation of youths by groups was rationalized from both a physical and psychological safety perspective, with environmental features being implemented to reduce the possibility of negative youth interactions such as peer manipulation and bullying.

3.1.2 Security

Participant responses related to the concept of security were directed at the environment's ability to monitor youth behavior and control movement when entering, leaving, and while inside the facility. Discussions pertaining solely to the security of the CS heavily focused on the facility's layered security, control over youth movement, and observational capabilities. Multiple layers of security were recognized as a design strategy that provided overlapping perimeters, both outside and within the facility, and helped distinguish between varying levels of environmental controllability (e.g., sally ported doorways between different security zones). Movement control, which was heavily referenced by interview participants as the bare necessity for a secure environment, pertained to ecological features used to control youth access and movement (e.g., door locking hardware). Lastly, the observation of youths was discussed as it related to direct and indirect modes of surveillance. Participants voiced that direct observation (e.g., supervision via sightlines) was the preferred form of surveillance as it passively discouraged unwanted youth behavior. In contrast, indirect observation (e.g., security cameras) was mainly used to recount events after they had already occurred.

3.2 Treatment and Rehabilitative Setting

When using the design perspective that the CS was a treatment and rehabilitative setting, respondents chiefly focused on concepts related to developing nurturing and empowering environments. Participants frequently referenced the CS's need to evoke a sense of hope and joy. This goal was considered one of the project's core guiding principles and was mirrored in all youth inhabited spaces. Similarly, participants discussed the imperative of removing and/or minimizing youth feelings of "dread" that were associated with the experience of being admitted to a secure juvenile treatment facility. Additionally, participants discussed the importance of empathy as a tool for the provocation of positive youth experiences. Respondents frequently discussed how they had, to the best of their abilities, attempted to imagine spaces from a juvenile youth's point of view when making decisions that would affect their environments.

3.2.1 Nurturing

Participant responses that addressed nurturing environments focused on the support and encouragement of treatment that would lessen youth anxiety and the risk of re-traumatization. When probed about how an environment could be made nurturing, participants pointed to environmental features used to eliminate or mitigate the incitement and/or exacerbation of youth stress (e.g., cramped spaces) and lessen youth discomfort/irritation (e.g., comfortable furniture). Similarly, discussions aimed at improving youth experiences in the CS tended to be drawn towards the implementation of positive distractions (e.g., daylighting), which can broadly be described as ecological features that block worrisome thoughts by eliciting pleasant psychological and physiological sensations.

3.2.2 Empowering

Participant discussion regarding the development of empowering environments focused on providing youths with the perspectives, opportunities, and knowledge required to take control of their lives and rejoin society. The concept of empowerment was multifaceted, and participant thoughts were mainly divided into three categories. First, respondents discussed environmental features intended to promote occupant engagement and elicit positive sentiments from youths concerning their treatment, environment, and staff (e.g., a non-institutional aesthetic). Youth engagement was further expanded via the concept of stimulation, which respondents helped to define as environmental features that physically or psychologically prompted youth interest, enjoyment, and enthusiasm (e.g., spaces for recreation, art, and music). Second, respondents discussed the social interactions between youths and youth and staff. These discussions focused on environmental features that facilitated appropriate social interactions and youth collaboration, such as the proximity and accessibility of nurses' stations to youths.

Calculated risk-taking was also heavily discussed by participants and defined as providing the youths with opportunities for personal growth (i.e., youths were placed in situations where they could potentially make mistakes). Participants discussed calculated risk-taking via the facility’s multi-wing facility design and how it manifested itself as an extension of the CS’s treatment program. The CS’s multi-wing facility design is best described as a series of housing pods (i.e., groups of bedrooms and auxiliary spaces such as nurses’ stations) that sequentially become less restrictive as youth progress through the treatment program. In this manner, as youths become more adept at controlling their behavior, thus earning the facility staff’s trust, they are moved into housing pods that progressively provide more access to amenities and freedoms. Participants explained that the goal of calculated risk-taking was to incentivize treatment while simultaneously providing youths with opportunities to develop an active familiarity with self-control and personal accountability. Trust, both from the youths and staff, was considered by participants as a precursor for reducing security and allowing greater youth control over their environments (e.g., being able to control window shades in their rooms). Additionally, flexibility was deemed by participants as critical to the success of calculated risk-taking. Although youths generally progress forward with their treatment, respondents expressed that it was not uncommon for youths to have sudden and temporary regressions in their behavior. Consequently, flexibility was deemed necessary to move youths easily and quickly between housing groups into spaces such as calm rooms designed to facilitate situational de-escalation.

3.3 Part of the Continuum of Care

Speaking from the design perspective that the CS was part of the juvenile justice system’s continuum of care, respondents concentrated on ideas related to external community connection. Respondents explained that fundamentally the main goal of the facility was to successfully treat and reintegrate youths back into communities as functioning members of society. Further elaboration by respondents revealed that a critical influencer of lasting youth reintegration was the establishment of social support networks that extend beyond the facility’s walls. In this manner, respondents identified environmental features intended to encourage and allow external community involvement with youths as they progressed through the treatment program, such as providing adequate spaces for visiting community instructors and potential employers. Additionally, respondents discussed the importance of facility propinquity regarding youth communities, the provision of adequate resources for comfortable and accessible visitation by the outside population (e.g., video conference rooms for families that cannot easily visit the facility), and the acknowledgment and consideration of the facility’s public image. These discussions centered around the implementation of design strategies that did not perpetuate negative perceptions (e.g., no barred windows) but instead portrayed a positive facility image similar to that of hospitals, schools, or university dormitories

4.0 RESULTS

As shown in Figure 2, findings from this research project were used to generate a conceptual adaptation of the TID model concerning the design considerations of secure juvenile treatment facilities.

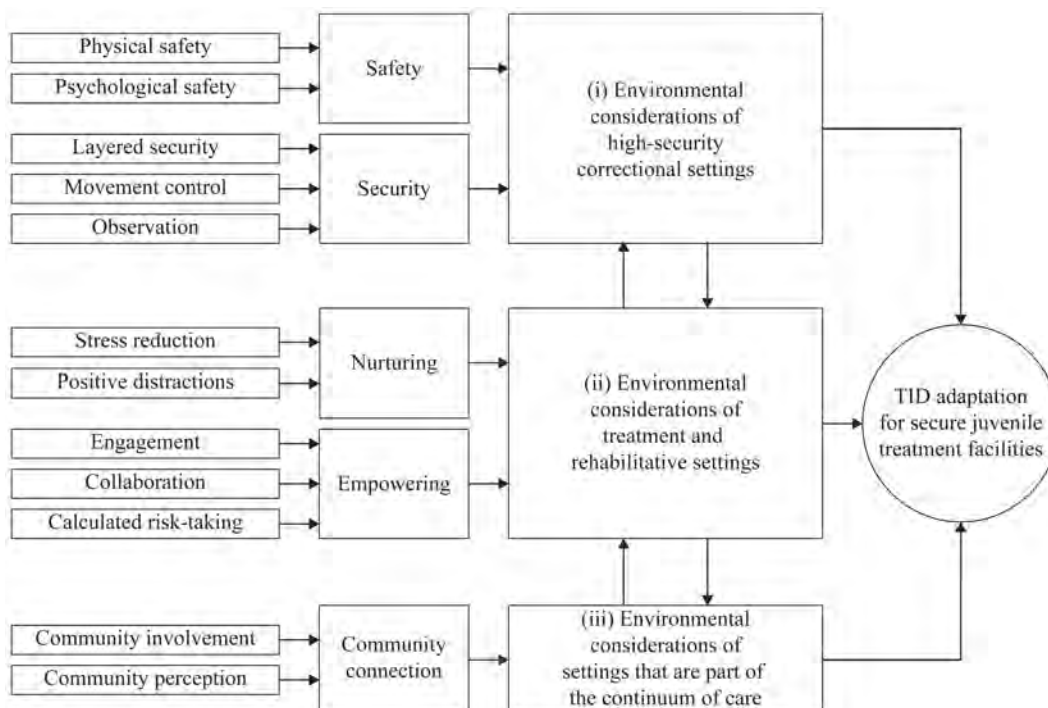

Figure 2: Adapted Trauma-informed Design Model

The adapted TID model mirrors respondent design perspectives from one-on-one interviews and divides constructs into three categories. As illustrated in Figure 2, since safety and security were recognized as principal mandates of corrections facilities (i.e., corrections facilities must at the very least be safe and secure), they were placed under the umbrella of environmental considerations inherent to high-security correctional settings (i). Similarly, nurturing and empowering were primarily associated with ecological features that supported and encouraged effective treatment and were placed under the category of environmental considerations intrinsic to treatment and rehabilitative settings (ii). Lastly, a secure juvenile treatment facility's ability to accommodate and invite community connection was accounted for via environmental considerations of a setting that is part of the juvenile justice system's continuum of care (iii). This latter category recognizes components of secure juvenile treatment facilities which extend beyond a facility's physical structure and help facilitate lasting youth reintegration and rehabilitation.

Although the adapted TID model does organize constructs into three categories, each category's associated constructs and subconstructs can influence those of others (e.g., psychological safety can influence an environment's ability to be nurturing). In this manner, design features mainly implemented in pursuit of one construct may facilitate or hinder the pursuit of another (e.g., too much security may inhabit an environment's ability to be empowering and vice versa). Thus, the unique and multi-faceted nature of secure juvenile treatment facilities requires a balanced awareness of environmental considerations inherent to a high-security correctional setting, treatment and rehabilitative setting, and a setting that is part of the juvenile justice system's continuum of care.

5.0 Conclusion

This research project determined that the TID model as defined by SAMHSA (2020) was not sufficient at holistically representing the design considerations of a secure juvenile treatment facility. Due to the multifaceted and unique nature of secure treatment facilities, an adaptation of the TID model was needed to account for additional design considerations not addressed by the original TID model. The adapted TID model used multiple design perspectives to organize and frame its principal constructs. Design perspectives used within the adapted model recognized secure juvenile treatment facilities as high-security correctional settings, treatment and rehabilitative settings, and as part of the juvenile justice system's continuum of care. Each design perspective provides unique insight into the, occasionally contradicting, objectives of secure juvenile treatment facilities. Additionally, the adapted TID model identifies the interconnected nature of its constructs and supports a balanced approach when designing facilities of this type.

Limitations of this research project included the lack of theoretical and empirical research regarding the influence of juvenile facility design on housed youths, the inability of the PI to visit the CS due to COVID-19 restrictions, the CS status as an extensive remodel as opposed to new construction (i.e., design limitation may have existed regarding the utilization of existing facility components and spaces), and the generalizability of research findings as only a single case site was investigated. Future research is recommended to utilize the developed conceptual model to conduct a multi-site investigation. This study approach is recommended to enhance the transferability and trustworthiness of findings by comparing data across multiple cases (Yin, 2003). Additionally, it is recommended that future research utilize site visits for collecting data or as a confirmation tool for alternate data collection methods. Finally, this investigator humbly requests that more researchers and professionals contribute to the improvement of secure juvenile treatment facilities by sharing their unique expertise and insights. As researchers, design practitioners, policymakers, and humans, we must go beyond simply feeling empathetic and take action. In this manner, I leave you with the following statement from one of my interview participants:

Sometimes people feel, out of empathy for another person or persons when something bad is happening, . . . they only feel bad, and nothing comes out of it. [My] criticism is that true empathy is doing something, and the doing, in this case, is creating a building for the purpose of helping [youths].

REFERENCES

- Abram, K. M., Teplin, L. A., Charles, D. R., Longworth, S. L., McClelland, G. M., and Dulcan, M. K. 2004. *Posttraumatic stress disorder and trauma in youth in juvenile detention*. Archives of General Psychiatry, 61(4), 403.
- Andrade, C., and Devlin, A. 2015. *Stress reduction in the hospital room: Applying Ulrich's theory of supportive design*. Journal of Environmental Psychology, 41, 125-134.
- Andrade, C. C., Devlin, A. S., Pereira, C. R., and Lima, M. L. 2017. *Do the hospital rooms make a difference for patients' stress? A multilevel analysis of the role of perceived control, positive distraction, and social support*. Journal of Environmental Psychology, 53, 63-72.
- Bernard, T. J., and Kurlychek, M. C. 2010. *The cycle of juvenile justice*. New York, NY: Oxford University Press.
- Bower, I., Tucker, R., and Enticott, P. G. (2019). *Impact of built environment design on emotion measured via neurophysiological correlates and subjective indicators: A systematic review*. Journal of Environmental Psychology, 66, 101344.
- Cauffman, E. 2004. *A statewide screening of mental health symptoms among juvenile offenders in detention*. Journal of the American Academy of Child & Adolescent Psychiatry, 43(4), 430-439.
- Centers for Disease Control and Prevention. 2013. *Injury prevention & control: Web-based injury statistics query and reporting system*. <https://www.cdc.gov/injury/wisqars/index.html>

- Chassin, L. 2008. *Juvenile justice and substance use*. The Future of Children, 18(2), 165-183.
- Creswell, J. W., and Poth, C. N. 2018. *Qualitative inquiry and research design: choosing among five approaches*. Thousand Oaks, CA: Sage.
- Darling, N. 2007. *Ecological systems theory: The person in the center of the circles*. Research in Human Development, 4(3-4), 203-217.
- Fazel, S, Doll, H, and Langstrom, N. 2009. *Mental disorders among adolescents in juvenile detention and correctional facilities: posttraumatic stress disorder is overlooked*. Journal of the American Academy of Child and Adolescent Psychiatry, 48(3), 340.
- Ford, J. D., Hartman, J. K., Hawke, J., and Chapman, J. F. 2008. *Traumatic victimization, posttraumatic stress disorder, suicidal ideation, and substance abuse risk among juvenile justice-involved youth*. Journal of Child & Adolescent Trauma, 1(1), 75-92.
- Gallagher, C., and Dobrin, A. 2005. *The association between suicide screening practices and attempts requiring emergency care in juvenile justice facilities*. Journal of the American Academy of Child and Adolescent Psychiatry, 44(5), 485-493.
- Gallagher, C., and Dobrin, A. 2006. *Deaths in juvenile justice residential facilities*. Journal of Adolescent Health, 38(6), 662-668.
- Gerber, M. R. 2019. *Trauma-informed healthcare approaches: A guide for primary care*. Cham, Switzerland: Springer.
- Goldstein, N. E., Arnold, D. H., Weil, J., Mesiarik, C. M., Peuschold, D., Grisso, T., and Osman, D. 2003. *Comorbid symptom patterns in female juvenile offenders*. International Journal of Law and Psychiatry, 26(5), 565-582.
- Hayes, L.M. 2004. *Juvenile Suicide in Confinement: A National Survey*. Mansfield, MA: National Center on Institutions and Alternatives.
- Kemp, K., Yurasek, A. M., Poindexter, B., Webb, M., and Tolou-Shams, M. 2020. *Suicide screening among youth at first court contact*. Archives of Suicide Research, 1-13.
- Kumar, Shailesh, and Ng, Bradley. 2001. *Crowding and violence on psychiatric wards: explanatory models*. Canadian Journal of Psychiatry, 46(5), 433-437..
- Liempd, I. H., Paz, O. O., and Leseman, P. P. 2020. *Do spatial characteristics influence behavior and development in early childhood education and care?* Journal of Environmental Psychology, 67, 101385.
- Marcus, P., and Alcabes, P. 1993. *Characteristics of suicides by inmates in an urban jail*. Psychiatric Services, 44(3), 256-261.
- Mazumdar, S. 2000. *Design professionals and the built environment: An introduction*. In P. L. Knox & P. Ozolins (Authors), *Design professionals and the built environment* (pp. 157-169). Chichester: Wiley.
- Mulligan, S., and Neistadt, M. E. 2003. *Occupational therapy evaluation for children: A pocket guide*. Philadelphia: Lippincott Williams & Wilkins.
- Nicholson-Crotty, S., Birchmeier, Z., and Valentine, D. 2009. *Exploring the impact of school discipline on racial disproportion in the juvenile justice system*. Social Science Quarterly, 90(4), 1003-1018.
- Nijman, H. L. 2002. *A model of aggression in psychiatric hospitals*. Acta Psychiatrica Scandinavia, 106(S412) 142-143.
- Office of Juvenile Justice and Delinquency Prevention 2019. *Easy Access to the Census of Juveniles in Residential Placement*.
- Olafson, E., Boat, B. W., Putnam, K. T., Thieken, L., Marrow, M. T., and Putnam, F. W. 2016. *Implementing trauma and grief component therapy for adolescents and think trauma for traumatized youth in secure juvenile justice settings*. Journal of Interpersonal Violence, 33(16), 2537-2557.
- Peditto, K., Shepley, M., Sachs, N., Mendle, J., and Burrow, A. 2020. *Inadequacy and impact of facility design for adolescents and young adults with cancer*. Journal of Environmental Psychology, 69, 101418.
- Sariaslan, A., Lichtenstein, P., Larsson, H., and Fazel, S. 2016. *Triggers for violent criminality in patients with psychotic disorders*. JAMA Psychiatry (Chicago, Ill.), 73(8), 796-803.
- Schubert, C., Mulvey, E., and United States. Office of Juvenile Justice Delinquency Prevention, issuing body. 2014. *Behavioral Health Problems, Treatment, and Outcomes in Serious Youthful Offenders*.
- Shelton, D. 2000. *Health status of young offenders and their families*. Journal of Nursing Scholarship, 32(2), 173-178.
- Shufelt, J., and Coccozza, J. 2006. *Youth with Mental Health Disorders in the Juvenile Justice System: Results from a Multistate Prevalence Study*. Research and Program Brief, 1-6. Delmar, N.Y.: National Center for Mental Health and Juvenile Justice.
- Snyder, H. N., and Sickmund, M. 2006. *Juvenile offenders and victims: 2006 national report*. Washington, DC: U.S. Dept. of Justice, Office of Justice Programs, Office of Juvenile Justice and Delinquency Prevention.
- Substance Abuse and Mental Health Services Administration (n.d.). Retrieved October 01, 2020, from <https://www.samhsa.gov/>
- Teplin, L. A., Abram, K. M., McClelland, G. M., Dulcan, M. K., and Mericle, A. A. 2002. *Psychiatric disorders in youth in juvenile detention*. Archives of General Psychiatry, 59(12), 1133.
- Ulrich, R. S. 2019. *Evidence-Informed Design Recommendations for Juvenile Facilities in Sweden: Report prepared for the Swedish National Board of Institutional Care (SiS)*. Gothenburg Sweden: Chalmers Reproservice.
- Ulrich, R. S., Bogren, L., Gardiner, S. K., and Lundin, S. 2018. *Psychiatric ward design can reduce aggressive behavior*. Journal of Environmental Psychology, 57, 53-66.
- Whitley, K., and Rozel, J. S. 2016. *Mental health care of detained youth and solitary confinement and restraint within juvenile detention facilities*. Child and Adolescent
- Yin, R. K.-Z. 2003. *Case study research: design and methods/ Third Edition*. London, Sage.

Evaluation of Net Zero Energy Buildings for Climate Resilience in Southeast U.S.

Manan Singh¹, Ryan Sharston¹

¹Florida Institute for Built Environment Resilience (FIBER), University of Florida, Gainesville, FL

ABSTRACT: As the climate change phenomenon rapidly accelerates, both adaptation and mitigation strategies to tackle its adverse effects on the environment are urgently recommended. Building sector, being a major contributor to the global greenhouse emissions also offers the most cost-effective mitigation potential through implementation of existing technologies, policies and building designs. Zero energy buildings (ZEBs) represent a combination of such technologies and are increasingly gaining relevance as a solution to mitigate climate-related impacts of the built environment. ZEBs are often designed based on the Typical Meteorological Year (TMY) weather data and validated based on annual energy performance in current climate. However, the current ZEB designs do not necessarily account for anticipated rise in temperatures, and as a result, lack resilience to future climatic conditions. The projected temperature rise will likely increase the cooling energy demand of buildings, which represents a substantial portion of overall energy consumption in the cooling dominated climates such as South-Eastern United States (U.S.). It is important to design the ZEBs for the future climate scenario to maintain their net zero status and ensure effective climate change adaptation. This paper evaluates a current ZEB prototype design for climate resilience and suggests financially feasible design strategies to ensure net zero status throughout the lifespan of ZEBs. Building energy simulations were conducted under current and future climate scenarios to determine the energy impacts of climate change on a ZEB located in Miami, FL. In conclusion, a “sensitivity analysis” conducted through varying major building envelope component properties indicated windows’ Solar Heat Gain Coefficient (SHGC) and the solar absorptivity of the outer envelope layers as the two most relevant design interventions concerning the relationship between building energy consumption and climate change. Lastly, an optimized ZEB design case is presented as an example of cost effective and climate resilient ZEB.

KEYWORDS: Climate Resilience, Building Envelope Components, Zero Energy Buildings

1.0 INTRODUCTION

Global mean temperature has already increased by 1.1°C (1.98°F) above the pre-industrial levels, leading to severe short- and long-term consequences (IPCC, 2021). The IPCC Working Group I sixth assessment report shows that the world will probably reach or exceed 1.5°C (2.7°F) rise in global temperatures within just the next two decades (IPCC, 2021). Concomitant with this are several environmentally adverse effects such as sea level rise and increased frequency and intensity of natural disasters that pose a serious threat to the well-being of communities worldwide. Considering the severity of these threats, both adaptation and mitigation strategies to combat such climatic changes are urgently recommended (UN News). In 2015, the Paris agreement outlined an international framework to limit the rise of global temperatures within 1.5°C above pre-industrial levels, which would significantly limit the impacts of climate change. Most experts agree that in order to meet this target, global carbon emissions must reach net zero by 2050 (Sikora A., 2021; Höhne, N., 2021; Pye et al., 2017). Buildings are responsible for nearly 40% of global greenhouse emissions, and hence, will have a major role to play in the efforts to tackle climate change. One major step towards global net zero carbon targets is the increased adaptation of Zero Energy Buildings (ZEBs). The U.S. Department of Energy (USDOE) defines ZEB as an energy-efficient building where, on a source energy basis, the actual annual delivered energy is less than or equal to the on-site renewable exported energy (Torcellini et al. 2006; Peterson et al., 2015). In other words, ZEBs consume only as much energy as can be produced onsite through renewable sources over a specified time.

Even though ZEBs form an important component of the plan to limit and tackle the global warming phenomenon, they themselves are not immune to the negative impacts of climate change. Current ZEB design paradigms not only do lack resilience to extreme weather events, but also their net zero energy status itself is questionable in projected future climatic conditions. Under current industry practices, the energy performance of ZEBs is evaluated using Typical Meteorological Year (TMY) weather files that represent typical weather conditions at a given location, based on past weather data. To elaborate, the energy performance of buildings, which has been analyzed according to weather conditions typical of past 30 years is also expected to hold true for the next 60 years. However, it is safe to assume that the ongoing and anticipated increase in global temperatures will have a substantial effect on building energy performance. In other words, higher global mean temperatures will result in increased cooling energy consumption and

decreased heating energy consumption with the magnitude of impact dependent upon the building location. Wherein cold climates, the cumulative changes in cooling and heating energy consumption may result in annual energy savings, the energy consumption will increase in hot climates. This is especially relevant in the southeast region of the U.S. where the annual energy consumption is primarily driven by cooling energy requirements, and hence, is anticipated to increase in future. Due to this reason, designing buildings in the southeast U.S. based on TMY files can lead to significant underestimation of annual energy consumption. In relation to the ZEBs, this implies that existing ZEB designs, per current weather conditions, are highly likely to lose their zero-energy status in the future. Such a scenario impedes the very purpose of ZEBs, and hence, needs to be addressed well in advance. To make certain that ZEBs continue to serve as a mitigation solution to the climate change, it is imperative to ensure that ZEBs not only are energy neutral under current climate but also in the future.

The most intuitive solution to this problem is designing ZEBs for future climatic conditions as opposed to the past ones (Amélie & Kummert, 2012). Particularly, in the context of hot climatic regimes such as southeastern U.S., this would mean that if a building is to continue as a ZEB throughout its lifespan, it has to be energy positive in the current weather scenario. An energy positive building is a building that produces more on-site energy from renewables than it consumes in a specific period of time. In other words, the future increase in annual energy consumption of buildings should be anticipated, accounted for, and offset by implementing energy saving strategies in new constructions as well as retrofitting projects. Although a variety of active design strategies and technology-oriented interventions such as renewable energy generation and daylighting systems can be used to achieve a net positive energy status, this paper exclusively focuses on the passive design strategies such as the envelope components of a building. Envelope components such as external walls, roof and windows act as the barrier between indoor and outdoor environment and can be considered as a building's "first line of defense" against the rapidly warming external environment. Therefore, Informed design interventions applied to these envelope components provide opportunities to limit and mitigate the impacts of warming external conditions before the additional heat enters the indoor environment. With the overarching aim of designing climate resilient ZEBs, this paper examines the various thermal properties of passive envelope components in the context of future climate projections to determine cost-effective solutions applicable to both new construction and retrofitting projects. To achieve the aim, we have evaluated the energy performance of a prototype ZEB located in Miami, FL, under current and future climate scenarios and presented a quantitative evaluation of the anticipated changes in energy performance resulting from climate change. Furthermore, we have conducted a sensitivity analysis involving major physical properties of passive envelope components such as thermal insulation, Solar Heat Gain Coefficient (SHGC) and thermal absorptance, to determine the relative effects of these properties in mitigating the energy impacts caused by the climate change. Lastly, in this paper, we have presented an optimized and cost-effective envelop design solution applicable to new and existing ZEBs, capable of achieving climate resilience with minimal design modification and associated investment cost.

2.0 METHODOLOGY

2.1. Energy Modeling and Optimization Parameters:

Building energy simulations were conducted for a ZEB building in current and future climate scenarios. USDOE's commercial building prototype model for small office building was selected to represent the baseline case for ZEB (Deru et al. 2011). A graphical rendering of the modeled building is shown in Figure 1. The building is comprised of a single floor with total floor area of 5,500 ft². Window-to-wall ratio is 24.4% for south façade and 19.8% for all other facades. The envelope construction properties follow ASHRAE 90.1 -2019 prescriptive requirements for Climate Zone 1. Thermostat setpoint is set at 75°F for cooling and 70°F for heating. The building was equipped with 30 kW rooftop PV system generating 47,218 kWh/ year (170 GJ), in line with the building energy requirements under current climatic conditions. PV calculations were conducted using PVWatts calculator provided by NREL (Dobos A. P.). Energy simulations were constructed using EnergyPlus software. To evaluate the major passive envelope component properties, each of the properties were iteratively varied and energy simulations were conducted for each variation under current and future climate scenarios. Envelope component properties evaluated in this study and their variation range are listed in Table 1. For the purpose of this study, the building system performance and envelope properties are assumed to stay relatively constant throughout the lifespan of the building (60 years).

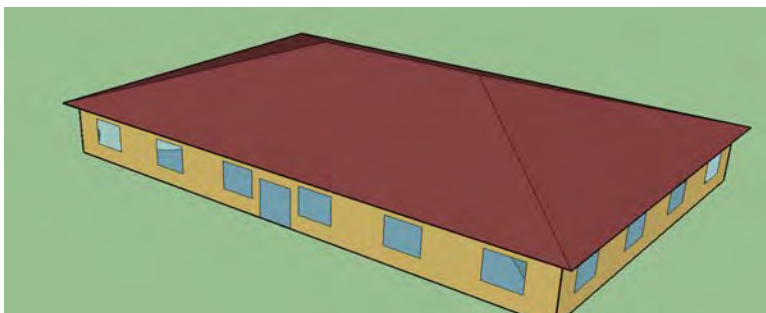

Figure 1: Graphical rendering of modelled small office building; Source: PNNL Scorecard (Deru et al. 2011)

Table 1: List of envelope component properties used as variable parameters

Parameter Name	Baseline Value	Variation range
Window insulation (R Value) [ft ² .h.°F/Btu]	2	1-12
Window solar heat gain coefficient (SHGC)	0.23	0.1-0.9
Roof insulation (R Value) [ft ² .h.°F/Btu]	37	25-55
Roof outermost layer solar absorptance	0.7	0.35-0.7
Roof outermost layer thermal absorptance	0.9	0.45-0.7
External wall insulation (R Value) [ft ² .h.°F/Btu]	11	10-30
External wall outermost layer solar absorptance	0.7	0.35-0.7
External wall outermost layer thermal absorptance	0.9	0.45-0.7

2.2. Future weather files:

Future weather files were obtained from WeatherShift in the EnergyPlus weather file (.epw) format (Weathershift). These future weather files are based on climate projections run for the Intergovernmental Panel on Climate Change (IPCC) fifth assessment report (AR5). The weather files have been created using a ‘morphing’ technique to transform historical time series data based on projected changes in the monthly averages of climatic variables (Brannon & Dickinson, 2016). To represent the worst-case scenario, future weather file based on Representative Concentration Pathways (RCP) 8.5-95% was selected for this study. RCP 8.5 scenario is also deemed as the best match out to midcentury, under current and stated global policies, which was considered as a suitable representation of climate change during the building lifespan (assumed as 60 years) (Schwalm et al., 2020). RCP 8.5 scenario represents minimal mitigation, which refers to additional radiative forcing of 8.5 W/m² in 2100. Since the projections are made following multiple climate change models, a 95% percentile indicates that 95% of the models lead to a temperature offset that is minor or equal to the offset.

A comparative analysis of major climatic parameters in current and future climate conditions was conducted prior to the evaluation of ZEB model. Figure 2 shows the monthly variation of degree days (DDs) in Miami under current and future climate scenarios. The current weather conditions are represented by the TMY file and future weather conditions are classified into three categories i.e., 2026-2045, 2056-2075 and 2080-2099. The monthly plot of Heating Degree Days (HDDs) calculated based on 18.3°C, shows a significant decrease in the number of HDDs in future. Total number of HDDs in a year under current conditions (TMY file) were calculated to be 67, which reduces to 33, 13 and 5 in 2026-2045, 2056-2075 and 2080-2099 respectively. This decreasing trend suggests that a consequent decrease in heating energy consumption can be anticipated in future conditions. As opposed to the variation of HDDs, the variation of Cooling Degree Days (CDDs) shows a gradual increase in future climate scenarios. Total number of annual CDDs increase from 2442 in current conditions to 3031, 3577, 4003 in 2026-2045, 2056-2075 and 2080-2099 respectively. This variation indicates that a significant increase in cooling energy consumption of buildings can be anticipated in future.

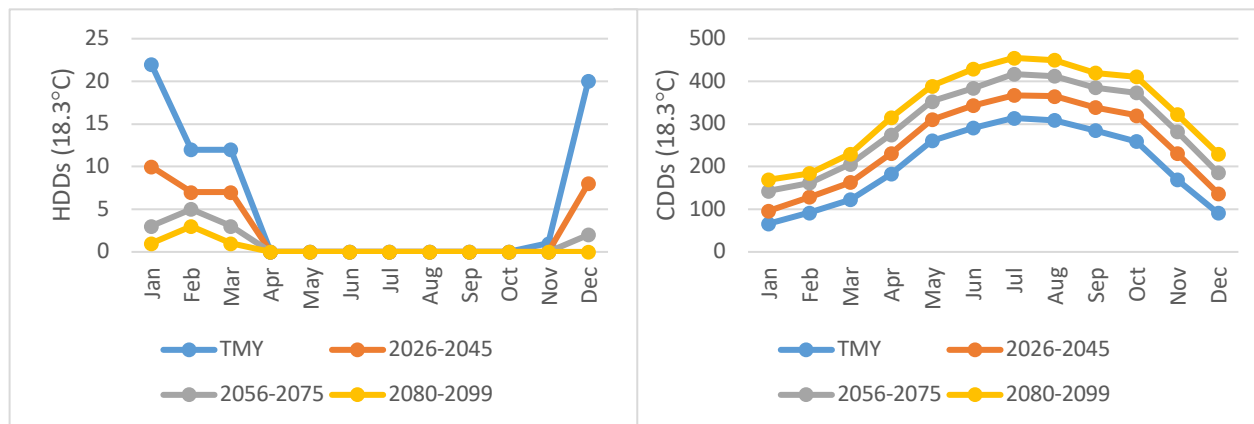

Figure 2: Monthly variation of HDDs (Left) and CDDs (Right) under current and future climate scenarios in Miami, FL

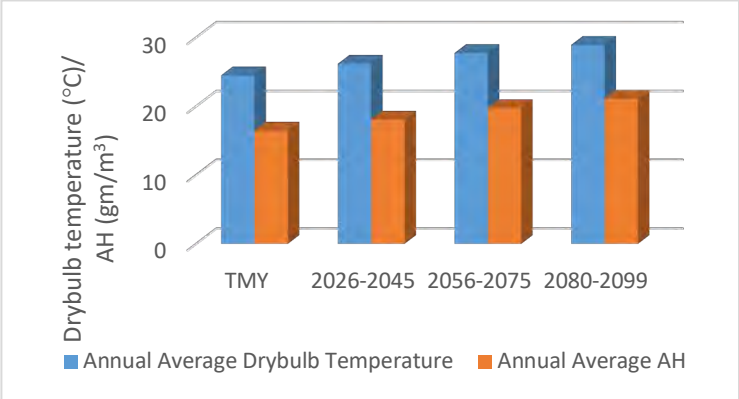

Figure 3: Annual average dry bulb temperature and absolute humidity in current and future scenarios on Miami

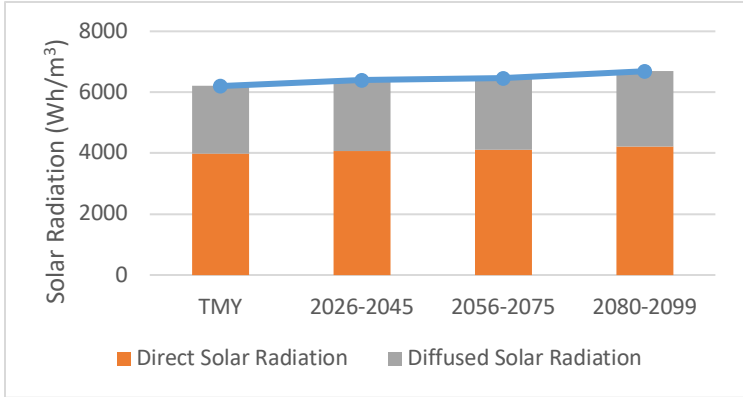

Figure 4: Annual average solar radiation in current and future climate scenarios in Miami, FL

Humidity parameters such as Relative Humidity (RH) and Absolute Humidity (AH) also play an important role in determining the latent heat load of the building. Since RH values are representative of the AH at a specific temperature, although RH is projected to remain relatively constant in the future climate scenarios, increasing dry bulb temperatures will cause a consequent increase in the AH parameter. Plotted in Figure 3, dry bulb temperatures show an increasing trend with annual averages increasing by 7%, 13% and 18% in 2026-2045, 2056-2075 and 2080-2099 respectively. Following the temperature trends, AH in 2026-2045, 2056-2075 and 2080-2099 will be higher by 10%, 20% and 28% respectively. Based on these trends, it is reasonable to assume that both sensible and latent heat loads for buildings will increase in the future. Solar radiation is another climate component that plays an important role in determining the envelope heat load. The future weather files indicate that both direct and diffused solar radiation will increase in the future scenarios, as shown in Figure 4. Total solar radiation is anticipated to be 3%, 4% and 8% higher in 2026-2045, 2056-2075 and 2080-2099 respectively. To address the anticipated increase in solar radiation, the thermal and solar absorption properties of the outermost layers of the envelope were included as variable parameters for this study. All these weather trends indicate a substantial increase in building cooling energy consumption and a decrease in building heating energy consumption, which is quantified in the following section.

3.0 RESULTS

3.1. Energy performance evaluation of ZEB in future climate scenarios:

The results of building energy simulations indicate a significant increase in the Energy Use Intensity (EUI) of the ZEB in future climate scenarios, as shown in Figure 5. The building EUI was calculated as 27.9 KBTU/ft² in the current climate scenario represented by TMY weather file. When simulated against future climate scenarios, EUI increased by 3.95% in 2026-2045, 7.2% in 2056-2075 and 10.4% in 2080-2099. The percentage increase in EUI corresponds to an additional requirement of 5,687 KBTU in 2026-2045, 11,279 KBTU in 2056-2075 and 16,028 KBTU in 2080-2099, a proportion that will increase with building size. Assuming that the renewable energy systems are designed to suffice the energy requirements of the building under current conditions (153,158 KBTU) as per ZEB definition, it is evidently clear that the same systems will not be sufficient to maintain the net zero status of the building in future conditions.

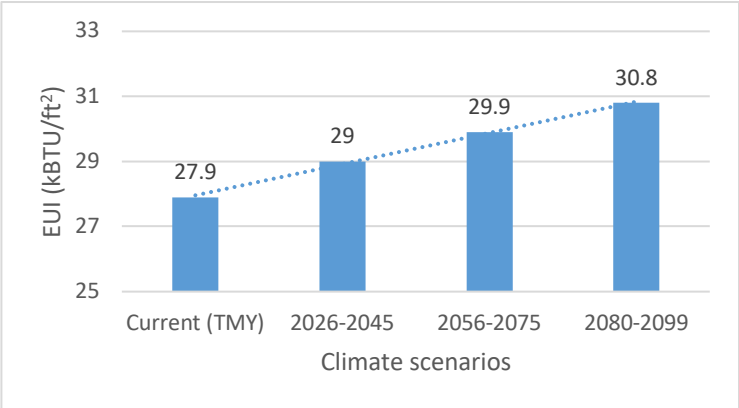

Figure 5: EUI comparison in current and future climate scenarios for Miami, FL

To evaluate the underlying mechanism of increase in annual energy consumption (EUI), different energy use components such as cooling, heating and lighting energy were examined separately. The heating energy consumption as well as its variation was found to be negligible due to the predominantly hot climatic conditions of Miami, FL. Internal loads such as lighting, and equipment use were constant in each scenario due to no direct relationship between these energy use components and climate change. The cooling energy consumption increased significantly in the future scenarios, as shown in Figure 6. Total cooling energy consumption was 13.4%, 24.8% and 34.9% higher than the current conditions in the respective climate change scenarios, which was in turn, the main driver behind the increase in the EUI.

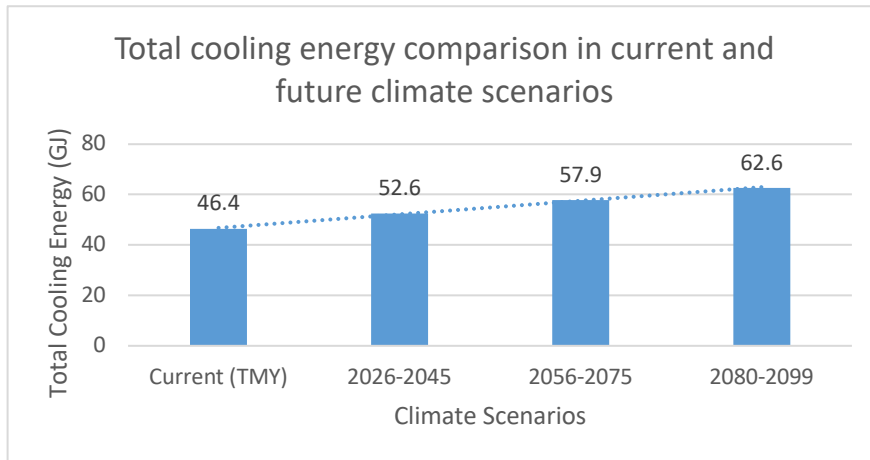

Figure 6: Total cooling energy comparison in current and future climate scenarios for Miami, FL

To examine the increase in cooling energy consumption in detail, heat transfer through envelope components was analyzed separately. Figure 7 shows the variation in heat transfer through transparent (window) and opaque envelope components in each climate change scenario. As is evident, the net heat transfer through opaque surfaces (external walls and roof) remains approximately constant with climate change whereas a significant increase was noted in terms of heat transfer through windows. These results suggest that windows play a much stronger role in terms of determining the impact of climate change on cooling energy consumption and subsequently on the EUI.

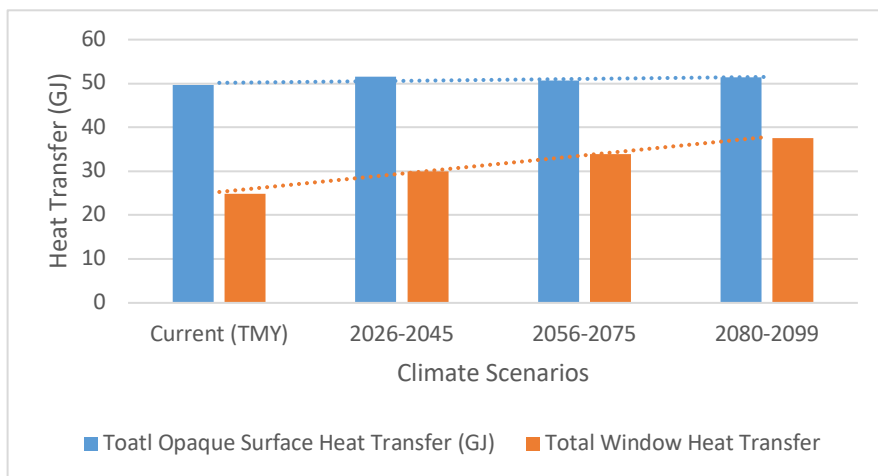

Figure 7: Envelope heat transfer variation in current and future climate scenarios for Miami, FL

3.2. Sensitivity analysis of passive envelope components.

To find an optimal passive design scenario, we conducted a sensitivity analysis where the major thermal properties of envelope components were iteratively varied, and then, the impact of each variation on energy matrices including EUI, cooling energy consumption, and net envelope heat transfer was analyzed. List of variable parameters and their variation range is provided in Table 1 (Section 2.1.). Main findings from the sensitivity analysis are listed as follows.

- Increasing *window insulation* had negligible impact on the building EUI. The reason behind this “insensitivity” was determined to be the balance between heat gain and heat loss through the windows. Higher window insulation not only did result in reduced heat gain but also reduced the heat loss. Due to the opposing effects of heat gain and heat loss through windows, the change in net window heat transfer due to increased insulation was negligible.
- The role of *window SHGC* was much stronger than that of the thermal insulation. Reducing the SHGC value caused a significant reduction in heat gain but no noteworthy reduction in heat loss. Due to this reason, lower SHGCs resulted in reduced heat transfer through windows, ultimately resulting in energy savings in current as well as future climate scenarios.
- The effect of increasing *wall and roof Insulation* was negligible on EUI as well as on cooling energy consumption. Although the envelope heat gain values reduced due to the increased insulation, the magnitude of impacts was negligible, particularly in the context of different climate change scenarios.
- *Thermal absorptance* of the outermost layer of external walls and roof were varied separately for each component and was noted to have a strong role in determining heat transfer through opaque envelope components. Reducing thermal absorptance caused an increase in envelope heat transfer, thus resulting in increased cooling energy consumption as well as the EUI. Based on these results, a higher thermal absorptance value would be beneficial with regards to warmer future climate.
- The role of *solar absorptance* of the outermost layer of external walls and roof was similar to that of thermal absorptance but with a positive proportionality. In other words, a decrease in solar absorptance of passive envelope components resulted in a decrease in EUI due to decreased heat transfer through opaque envelope components.

3.3. Optimized case example:

Based on the results of the “sensitivity analysis”, multiple combinations of relevant properties were applied to the ZEB model and the results were evaluated in current and future climate scenarios. The most optimal case is presented here as an example of a ZEB design that would remain zero energy throughout its lifespan (assumed 60 years). The approach was to modify passive design variables that can ensure the continuance of zero energy status throughout building lifespan, with minimum design modifications and associated financial implications. Based on the aforementioned sensitivity analysis, two highly significant envelope properties were determined as window’s SHGC and the solar absorptance of the outermost layer of roof and external walls. Physical manifestation of higher SHGC can be visualized as window tint and lower solar absorptance as light-colored paint (Dornellis et al., 2007). Therefore, the optimized case scenario was created solely based on modifications to these properties, leaving other major components such as insulation constant. Energy neutrality of the ZEB was successfully ensured through minimal changes to building design as listed in Table 2, along with the baseline design values for reference.

Table 2: Constant and modified passive design parameters under the optimized design case.

Parameter Name	Baseline Design	Optimized Design
Window Insulation (R Value)[ft ² .h.F/Btu]	2	2
Window SHGC	0.23	0.1
Roof Insulation (R Value)[ft ² .h.F/Btu]	37	37
Roof outermost layer solar absorptance	0.7	0.35
Roof outermost layer thermal absorptance	0.9	0.9
External wall Insulation (R Value)[ft ² .h.F/Btu]	11	11
External wall outermost layer solar absorptance	0.7	0.35
External wall outermost layer thermal absorptance	0.9	0.9

The energy simulation results of the optimized design scenario are presented in Figure 8 and 9. Figure 8 shows the EUI of optimized design case in current and future climate scenarios in comparison with the EUI of baseline case in current scenario. The EUI of optimized case in future climate scenarios within the building lifespan was calculated to be lower than the EUI of baseline case in current weather scenario. These results show that the optimized case not only continues to perform as a ZEB towards the end of its lifespan but also energy positive for majority of its functional life. The cooling energy consumption that was determined as the major driver of EUI of buildings located in Miami, FL is plotted in Figure 9. The optimized case ZEB shows a cooling energy consumption lower than in the baseline case for current and 2026-2045 scenario. Although cooling energy consumption was slightly higher than baseline case in the 2056-2075 scenario, the difference was not enough to increase the EUI above baseline, as presented in Figure 8.

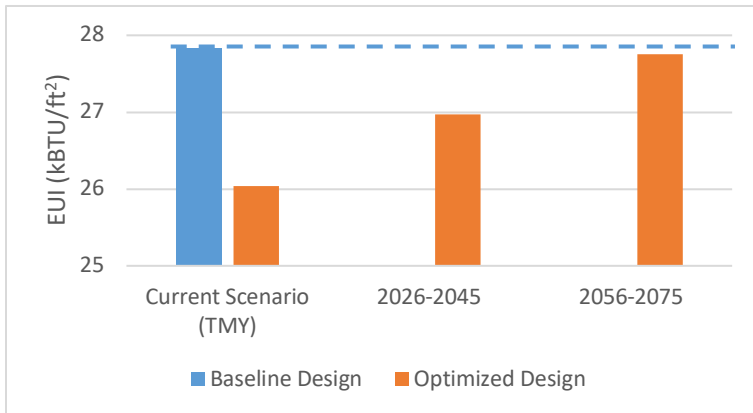

Figure 8: EUI comparison between baseline and optimized design case in current and future climate scenarios for Miami, FL

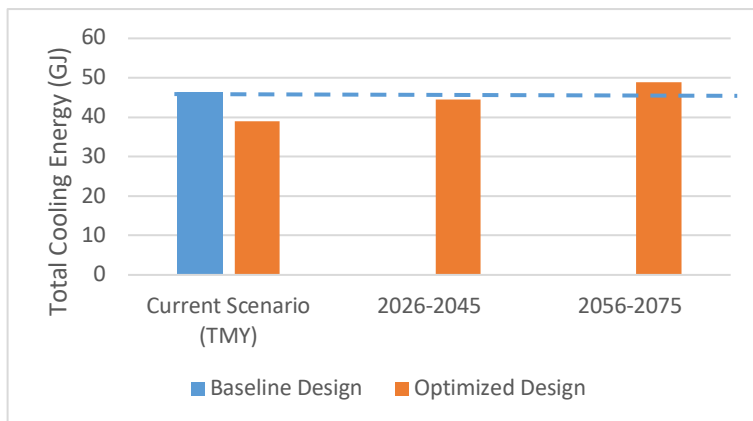

Figure 9: Total cooling energy comparison between baseline and optimized design case in current and future climate scenarios for Miami, FL.

4.0 CONCLUSION

This paper evaluates the energy performance of a ZEB in current and future climate scenarios to determine the impact of climate change on its zero-energy status in future. As the result of climatic changes, namely temperature increase, the building EUI was shown to increase by 3.95% in 2026-2045, 7.2% in in 2056-2075 and 10.4% in 2080-2099. These results suggest that the renewable energy systems designed for energy neutrality in current climate scenario will be insufficient to do so in future. Since these calculations are based on a small ZEB, the effect of climate change on the net zero status of larger buildings is expected to be higher. The main reason for the increased EUI in future was the increased cooling energy consumption driven primarily by higher heat gain through windows. A sensitivity analysis was performed to determine the relative relevance of major passive envelope component properties in mitigating the energy impacts caused by climate change. We observed that in Miami, FL the envelope insulation does not have a significant role in mitigating the effects of climate change. Higher envelope insulation was even found to increase the building EUI in certain cases, where reduction in envelope heat loss due to insulation was higher in magnitude than the reduction in envelope heat gain. Moreover, the window's SHGC and the solar absorptance of the outermost layer of opaque surfaces were found to be the most important envelope properties in terms of energy savings in future climate scenarios.

Based on the sensitivity analysis conducted in this study, we have presented an optimized design case as an example of cost-effective and climate resilient ZEB design. It was shown that the net zero status of optimized case ZEB until the end of its lifetime (60 years) can be achieved through modifying the SHGC and solar absorptance. The simplicity of suggested design strategies allows them to be applicable to both existing and new constructions. Not only will this enable maintaining the zero-energy status in future but also create energy savings with low investment costs. Since, the study conducted in this paper focuses exclusively on the hot climates prevalent in southeast U.S., further analyses are required to derive design guidance for cold and mild climate zones.

REFERENCES

- Peterson, K., Torcellini, P., Grant, R., Taylor, C., Punjabi, S., & Diamond, R. (2015). A common definition for zero energy buildings. US Department of Energy, Building America, Office of Energy Efficiency and Renewable Energy.
- Brannon, B., & Dickinson, R.E. (2016). Generating Future Weather Files for Resilience. PLEA 2016 Los Angeles, U.S.
- Christopher R. Schwalm, Spencer Glendon, Philip B. Duffy. RCP8.5 tracks cumulative CO2 emissions. Proceedings of the National Academy of Sciences, Aug 2020, 117 (33) 19656-19657; DOI: 10.1073/pnas.2007117117
- Dobos, A. P. PVWatts Version 5 Manual. United States. <https://doi.org/10.2172/1158421>. (Accessed November 3)
- Dornelles, Kelen & Roriz, Victor & Roriz, Mauricio. (2007). Determination of the solar absorptance of opaque surfaces. 10.13140/RG.2.1.2368.1764.
- M. Deru, K. Field, D. Studer, K. Benne, B. Griffith, P. Torcellini, B. Liu, M. Halverson, D. Winiarski, M. Rosenberg, M. Yazdani, J. Huang, D. Crawley, U.S. Department of Energy commercial reference building models of the national building stock, Publ. (2011).
- Masson-Delmotte, V., P. Zhai, A. Pirani, S.L. Connors, C. Péan, S. Berger, N. Caud, Y. Chen, L. Goldfarb, M.I. Gomis, M. Huang, K. Leitzell, E. Lonnoy, J.B.R. Matthews, T.K. Maycock, T. Waterfield, O. Yelekçi, R. Yu, and B. Zhou (eds.), 2021, IPCC, 2021: Climate Change 2021: The Physical Science Basis. Contribution of Working Group I to the Sixth Assessment Report of the Intergovernmental Panel on Climate Change, Cambridge University Press. In Press.
- Robert, Amélie, and Michaël Kummert. 2012. "Designing Net-Zero Energy Buildings for the Future Climate, Not for the Past." *Building and Environment* 55 (September): 150–58.
- Torcellini, P.; Pless, S.; Deru, M.; Crawley, D. (2006). "Zero Energy Buildings: A Critical Look at the Definition." ACEEE Summer Study on Energy Efficiency in Buildings, August 2006, Pacific Grove, CA. Golden, CO: National Renewable Energy Laboratory, 16 pp.
- WatherShift™ tool <http://www.weather-shift.com>. (Accessed November 3)
- UN News. <https://news.un.org/en/story/2021/08/1097362>. (Accessed November 3)
- Sikora, A. European Green Deal – legal and financial challenges of the climate change. *ERA Forum* 21, 681–697 (2021). <https://doi.org/10.1007/s12027-020-00637-3>
- Höhne, N., Gidden, M.J., den Elzen, M. et al. Wave of net zero emission targets opens window to meeting the Paris Agreement. *Nat. Clim. Chang.* 11, 820–822 (2021). <https://doi.org/10.1038/s41558-021-01142-2>
- Pye, S., Li, F., Price, J. et al. Achieving net-zero emissions through the reframing of UK national targets in the post-Paris Agreement era. *Nat Energy* 2, 17024 (2017). <https://doi.org/10.1038/nenergy.2017.24>
- IPCC, 2013: Summary for Policymakers. In: *Climate Change 2013: The Physical Science Basis. Contribution of Working Group I to the Fifth Assessment Report of the Intergovernmental Panel on Climate Change* [Stocker, T.F., D. Qin, G.-K. Plattner, M. Tignor, S.K. Allen, J. Boschung, A. Nauels, Y. Xia, V. Bex and P.M. Midgley (eds.)]. Cambridge University Press, Cambridge, United Kingdom and New York, NY, USA.

The Impact of Efficient Natural Ventilation on the Indoor Environmental Air Quality: The Case of a Social Housing in Turkey

Ezgi Bay¹, Antonio Martinez-Molina²

¹University of Utah, Salt Lake City, UT

²University of Texas at San Antonio, San Antonio, TX

ABSTRACT: As closed and crowded environments, buildings have become sites of rapid COVID-19 transmission. In these kinds of situations, particularly for countries whose residents are subject to curfews / full lockdown during long periods, natural ventilation is the most inexpensive and efficient cooling and ventilation alternative. This will provide better indoor quality for residents' health. Since wind drives natural ventilation together with the use of single sided and cross ventilation in a space, this paper focuses on how a renewable source such as natural ventilation helps to alleviate thermal and air quality related problems in a social housing in Turkey. After illustrating the current indoor conditions using a Computational Fluid Dynamics (CFD) analysis, authors propose a more efficient natural ventilation and cooling solution using wind driven ventilation for a social housing in Gaziantep, Turkey. It is assumed that this solution could be implemented in similar hot and arid climate areas (Köppen Csa Climate Zone) meeting occupants' thermal comfort. In addition to accelerating the air change rate in units, this solution could also increase the users' thermal satisfaction. Through Post-Occupancy Evaluation methodology and SPSS analysis, input from residents shows occupants' thermal stress. These results are compared with the Predicted Percentage of Dissatisfied (PPD) and Air Changes per Hour (ACH) values obtained from simulations using IES-VE software. This methodology is able to calculate the required time to naturally ventilate a structure. Since providing safe results to prevent asymptomatic or pre-symptomatic airborne transmission in indoor environments. Finally, in crowded social housing units, calculating ACH and provide alternatives will be a critical factor to help prevent the spread of the bacteria and viruses.

KEYWORDS: Air quality, social housing, natural ventilation, air renovation

INTRODUCTION

Shelter is one of the basic needs of a person to survive the harsh effects of outdoor environment since this necessity emerges for protection from dangers in natural conditions. The housing problem found a place among the social, economic and political problems in the period between the World Wars (Keles, 1966). Today, the housing need continues to increase due to various reasons such as rapidly expanding population in urban areas, recent migration, and relocations of people. Especially, many countries such as Turkey, have started to include housing policies especially for low-income groups in their agendas. It is clear that the issue is not only about quantity and high speed building production, but also related to quality since the content of the housing should reflect healthy, comfortable, and sufficient spaces beside being safe. Therefore, the most essential need for people is to reach an adequate standard of living.

Social housing policies in Turkey belong to a central administration called TOKI Mass Housing Authority (Toplu Konut Idaresi). This agency was established in 1984, to provide financial support for mostly residential projects. It is the main actor in the clearance and transformation of informal settlements (Dulgeroglu-Yuksel et. al, 2009). With the multiple regulations that passed in favor of this agency such as transfer of public lands allowed the institute plan and build projects on these state-owned lands (Akcan, 2015)

In this paper, one of the TOKI residential projects in southeast Turkey was analyzed in terms of ventilation characteristics. The residential project which was built for low-income groups in 2012 is located in the city of Gaziantep. The city's climate is defined as "dry-summer subtropical" with the Koppen Climate Classification subtype "Csa" (Mediterran Climate. In Gaziantep, the highest recorded temperature is 108°F (15.6°C) that was recorded in August. On the other hand, the lowest temperature was recorded in January which was 12°F (-11.1°C). While the warmest month, on average is July, the coldest one on average is January. The recorded average temperatures are 83°F (28.3°C) and 38°F (3.3°C) on July and January, respectively (Weather Base).

As the 3B climate zone (ASHRAE 90.1) and Csa- Mediterranean Climate (Köppen), Gaziantep has cold winters and usually hot and dry summers. According to Turkish State Meteorological Service (2020), temperatures are above 30°C in summer season with low relative humidity and high evaporation. Gaziantep's southwest prevailing winds favor the strong air flow in buildings. This provides a potential to alleviate also hot temperatures and bringing fresh air.

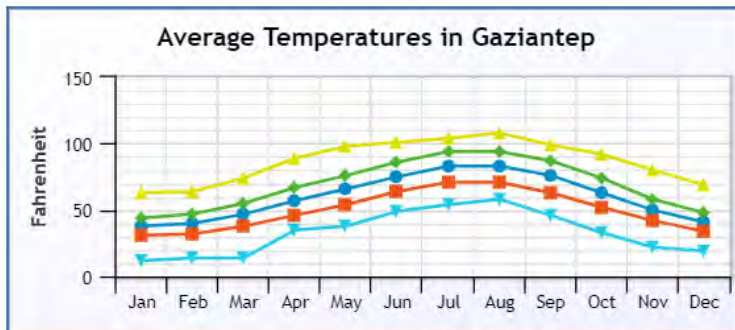

Figure 1: Average Temperatures in Gaziantep Source: (Weather Base. 2021)

Although unwanted environmental conditions such as inconsistent wind speed and direction (Rong et al, 2015; Yang & Zhao 2012), changing weather conditions (Shi et al., 2018), and outdoor pollutants and dust may be shown as responsible for the unsatisfactory indoor air quality in naturally ventilated buildings, in the case of TOKI, this issue was ignored because of various reasons. According to the surveys, no evidence was found in terms of bad air quality entering through windows which are the only ventilation method for these low-income users.

The reason why a social housing project was selected as a case study is that these stigmatized projects unfortunately have created socially and environmentally vulnerable spaces. Especially, under the affects of the COVID pandemic, people started to spend most of their time indoors. Last two years, Turkish Government imposed COVID-19-related curfew in multiple times including weekday curfew periods and partial weekend curfew periods (GardaWorld 2021). During these nationwide curfew hours, people pushed to stay their homes to avoid an increase in infection rates. Therefore, the importance of having a good level of indoor air quality and a well-organized public space for well-being have been discussed as critical parameters to advance equity in the built environment. The aim of this paper is to reveal if the selected project provides a good level of air renovation in units. In addition to this, accessibility and equitability in these spaces will be discussed.

1.0 METHODOLOGY

1.1 Computational Fluid Dynamic (CDF) Simulations

In this study, both external and internal CFD simulations were created. To assess the air quality, air renovation in units is used as a key performance indicator for this methodological step. First, wind conditions in the city are analyzed to understand wind statistics, seasonal wind directions and velocities. Using the software IES-VE, wind flows in units are tested via internal CFD simulations in the units of TOKI project. As a subsequent step, ACH levels are calculated. In the first series, the project is modeled with its six towers in IES and examined in Micro-Flo during a five-month period from May to September for external simulations. Also, the timelapse of internal CFD simulations in a tower was applied to single instances in time via three dates (May 17, June 14 and September 21). The selected dates have the largest natural ventilation potential during the warm period in Gaziantep.

For the accuracy of the model, 3.7 million CFD grid cells are used in the domain which is divided into small blocks for the applications of computational equations (IES VE Microflo User Guide, 2015). The grid spacing was determined as 2 meters. Also, k-epsilon turbulence model that is widely used and calculates turbulent viscosity is selected for simulating the air flow. For upwind, downwind, sides and above, grid dimensions are accepted as 174m, 522m, 139m, and 208m, respectively. Outdoor weather conditions were simulated using the weather data obtained from the local Gaziantep weather station.

1.2. Post Occupancy Evaluation

After a series of CFD simulations, the dynamics of interaction between airflow and thermal comfort of occupants of the TOKI project is analyzed using Fanger's Predictive Mean Vote, PMV model. In addition, as a next step, a post occupancy survey was conducted in this project. The survey focused on occupants' perception about their living environment, ventilation performance of their units, environmental satisfaction and overall, their experience. The main goal is to understand objective and subjective factors which are directly connected to the residents' satisfaction. A random sample of 143 residents responded to a questionnaire. 94% of these users that are housewives, represented their household (50 % households of the project) during the interviews. The probability of a subject being selected for

this survey depended on their willingness to participate and availability at home during the surveying time to be surveyed. Findings were analyzed in SPSS Statistical tool.

2.0 RESULTS

Air flow process occurring withing and around the buildings was simulated via CFD analysis. The wind flow led into aisles by the alignment of the towers was observed at different levels. The flow acceleration on different levels and the interaction with windward and leeward surfaces were observed. Figure 2 displays the conditions of facades and different alignments. For every tower, speeds on windward and leeward surfaces are tabulated for each floor. Creating a velocity profile across height. This analysis showed that the maximum intensity was reached on level 9. Was clear that velocity is more homogeneous across the height in leeward surfaces.

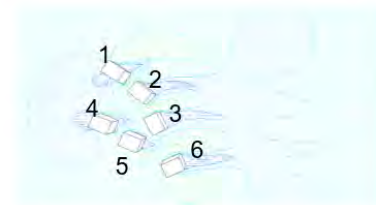

ETILER TOKI		TOWER 1		TOWER 2		TOWER 3		TOWER 4		TOWER 5		TOWER 6	
Floor	Level (m)	Windward m/s	Leeward m/s	Windward m/s	Leeward m/s	Windward m/s	Leeward m/s	Windward m/s	Leeward m/s	Windward m/s	Leeward m/s	Windward m/s	Leeward m/s
1	1.58	0.04	0.04	1.79	0.62	0.04	0.04	0.62	0.04	0.62	0.04	1.21	0.62
2	4.75	0.62	0.04	1.79	0.04	1.79	0.04	0.62	0.04	1.21	0.62	1.79	1.21
3	7.91	1.79	0.04	1.79	0.04	1.79	0.62	1.79	0.04	1.79	0.62	1.79	1.21
4	11.07	1.79	0.62	1.79	0.62	1.79	0.62	1.79	0.62	1.79	0.62	1.79	0.62
5	14.24	2.37	0.62	2.37	0.62	2.37	0.62	2.37	0.62	1.79	1.21	2.37	0.62
6	17.4	2.37	1.21	2.37	1.21	2.37	1.21	2.37	1.21	1.79	1.21	2.37	1.21
7	20.56	2.96	1.21	2.96	1.21	2.96	1.21	2.96	1.21	2.37	1.79	2.96	1.21
8	23.73	2.96	1.21	2.96	1.21	2.96	1.21	2.96	1.21	2.37	1.79	2.96	1.21
9	26.89	3.54	1.21	3.54	1.21	3.54	1.21	3.54	1.21	2.37	1.21	3.54	1.21
10	30.05	3.54	1.21	3.54	1.21	3.54	1.21	3.54	1.21	2.37	1.79	3.54	1.21
11	33.22	3.54	1.21	3.54	1.21	3.54	1.21	3.54	1.21	2.96	2.37	3.54	1.21
12	36.21	3.54	1.21	3.54	1.21	3.54	1.21	3.54	1.21	2.96	2.37	3.54	1.21

Figure 2: Velocity levels across height: (Bay, 2020)

Two key performance indicators predicted percentage of dissatisfied (PPD) and air changes per hour (ACH) were used and compared with the survey outputs. It is found that among the selected three dates, May has the lowest velocity while June is the month with the highest velocity values. This increases cross ventilation inside units. Under summer peak temperatures in May and June, air renovation was higher on June 21 due to higher air velocities. Modeled units on the third level reached 2 ACH in September (Table 1).

Table 1: Average values on the third level units: Air changes and people dissatisfaction. Source: (Bay, 2020)

Date	ACH	PPD %
<i>(9.30 am)</i>		
May 17	0.9	6.7
Jun 14	4.6	10.5
Sep 21	2	9.3

From the software, PPD levels on May, June and September were also documented for 9.30 am (Table 1). Compared to other two selected days, higher number of occupants felt dissatisfied in their thermal environment on June 14th These findings were compared to the POE results. Surveys showed that only 25% of users expresses an acceptable satisfaction with their indoor thermal conditions. When asked about the open public space, they showed a dissatisfaction of 80%. Overall, more than 60% of people expressed a thermal sensation “above neutrality during the warm period when surveys were conducted (Figure 3).

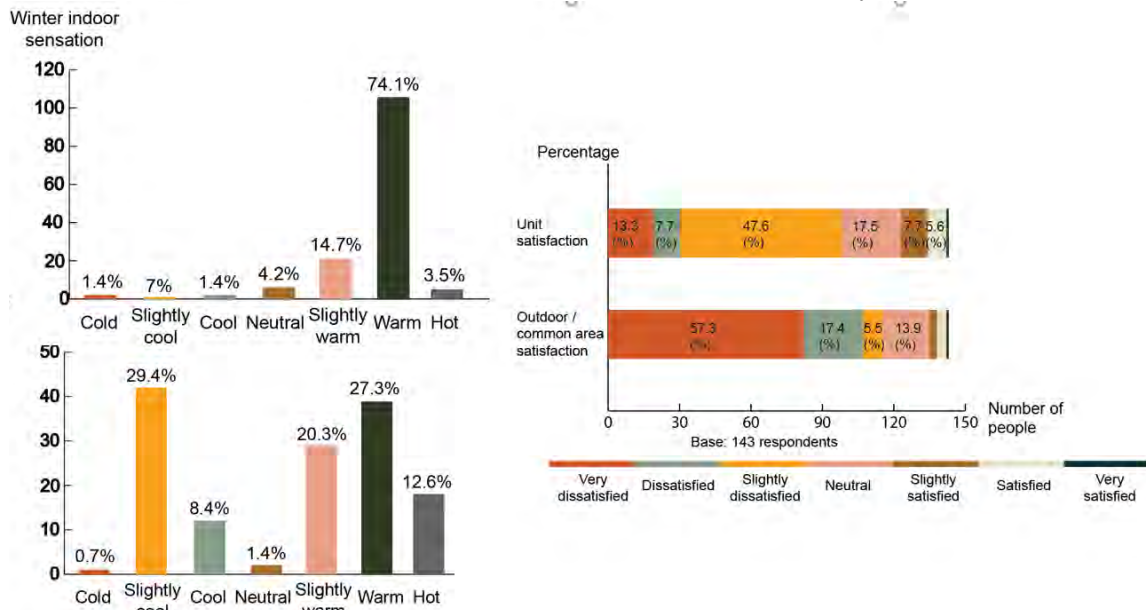

Figure 3: Thermal sensation of occupants (left) and satisfaction levels about indoor and outdoor areas (right) (Bay, 2020)

As a final step, in SPSS, the interdependence between air flow performance and thermal sensation was analyzed and positive correlation was found. When air flow increases on unit, there is also an increment of 0.357 in the thermal satisfaction. According to the coefficient table of the analysis, adjusted R square shows that 12 percent of the variance of the thermal sensation is predictable from air performance. Other variables such as personal preferences, metabolic rate, age, and gender may explain this number. A 5 percent of p value was considered as reasonable level in order to claim the result is statistically significant.

CONCLUSION

This paper analyzes the current conditions of a TOKI social housing project, its users' satisfaction level and ventilation performance under the influence of COVID-19 pandemic. Exemplified TOKI social housing projects in Turkey provide safer and healthier infrastructure especially for low-income communities. The conclusion of this paper is that low thermal satisfaction of the occupants can be associated with ventilation performance in these units. Wind-driven ventilation possibilities, specifically cross ventilation can be applied with the new typological alternatives. New results can be tested changing parameters such as different window-to-wall ratio values, increased façade surfaces, porous design and void spaces as vents that enhances cross ventilation and air renovation in units. These improvements will provide better indoor air quality while help to increase overall occupant satisfaction. Especially, connected outdoor spaces, well-defined green areas and outdoor and indoor community spaces will provide a healthier and more comfortable places in catastrophic periods such as COVID 19 for poorer communities.

REFERENCES

- Akcan, E. 2015. *The 'occupy' turn in the global city paradigm: The architecture of AK party's Istanbul and gezi movement*. Journal of the Ottoman and Turkish Studies Association, 2 (2), Indiana University Press, 359-378.
- Bay, E. 2020. *Natural ventilation as an architectural instrument: Case study of Gaziantep, Turkey*. Prometheus, 4, 78-83
- Bay, E. 2020. *The spatial block: Natural ventilation in hot and dry climates of Turkey*. PhD dissertation, Illinois Institute of Technology.
- Dulgeroglu-Yuksel, Y. & Pulat-Gokmen, G. 2009. *Changing of mass housing production by the government in Turkey*. European Network for Housing Research. 21st Conference. Changing Housing Markets: Integration and Segmentation. Prague, Czeck Republic.
- IES VE Microflo User Guide. 2015. Retrieved from <https://www.iesve.com/downloads/help/ve64/CFD/MicroFlo.pdf>
- Garda, 2021. *Turkey: Government announces nationwide COVID-19 curfew April 22-26 / update 37*. Retrieved from <https://www.garda.com/crisis24/news-alerts/470281/turkey-government-announces-nationwide-covid-19-curfew-april-22-26-update-37>
- Keleş, R. 1966. *Sosyal konut politikası kavramı üzerinde bir deneme ve Türkiye'de sosyal konut politikası*. Ankara Üniversitesi SBF Dergisi, 21(2).
- Köppen Climate Classification
- Shi, Z., Qian, H., Zheng, X., Lv, Z., Li, Y., Liu, L., & Nielsen, P.V. 2018. *Seasonal variation of window opening behaviours in two naturally ventilated hospital wards*. Building and Environment, 130, 85-93.
- TOKI. Retrieved from <https://www.toki.gov.tr/en/>
- Turkish State Meteorological Service. Retrieved from <https://www.mgm.gov.tr/files/en-us/climateofturkey.pdf>
- Weather Base, 2021. Retrieved from <https://www.weatherbase.com/weather/weather-summary.php3?s=6271&cityname=Gaziantep,+Turkey>
- Yang, Y., Zhao, Y. 2012. *Prevailing wind direction forecast for natural ventilation adjustment in greenhouses based on LE-SVM*. Energy Procedia, 16, 252-258.

Efficacy of External Shading Devices and Natural Ventilation during Extreme Heat for a Seattle Multi-family Apartment Unit

Teresa Moroseos¹, Heather Burpee¹, Christopher Meek¹

¹Integrated Design Lab, University of Washington, Seattle, WA

ABSTRACT: Seattle is especially vulnerable to excessive heat events due its historically mild summers. Since the mid-1970s, there have been on average three to four heat-related fatalities every summer in Seattle. In 2021, an exceptionally hot summer, over 60 deaths occurred. Excessive heat events are expected to rise in the near future, increasing the risk of mortality and morbidity related to overheating. Groups most at risk are the elderly, infants, the homeless, and the poor who are socially isolated. While the percentage of homes with air conditioning is increasing, there is a risk that excessive heat could overload the energy grid system if air conditioning becomes widespread. External shading devices and natural ventilation are well-known passive design strategies that reduce cooling loads and improve thermal comfort. While their benefits are recognized among architects and engineers, there is very little research on their efficacy during excessive heat for residential typologies in mild climates. We conducted a study to assess the interior ambient conditions for a prototypical, west-facing apartment unit in Seattle for historic and projected 2050 weather data. We also studied whether external shading devices and natural ventilation can effectively improve indoor ambient conditions during hot weather in Seattle. The research was conducted using simulation-based energy models, with several simulations cases studied by varying building parameters including exterior shading devices, natural ventilation strategies, infiltration rates, window assembly, and wall assembly. An annual energy analysis was performed for all simulation cases to assess interior ambient conditions. Our results show that a prototypical, west-facing apartment unit has interior ambient conditions that are detrimental to human health in many of the simulations that we studied, especially for the projected 2050 weather, but even for historic weather conditions. The best mitigation strategy that we assessed was incorporating natural ventilation, followed by incorporating exterior shading.

KEYWORDS: Excessive heat events, heat index, passive cooling, exterior shading devices, natural ventilation

1.0 INTRODUCTION

1.1 Excessive Heat Events and Human Health

Climate change is increasing the occurrence of excessive heat events throughout the world (Sheridan 2018). Excessive heat events, or periods of unusually high summer temperatures compared to local historical trends, can be completely catastrophic and result in thousands of deaths, such as the 2010 Moscow heat wave that killed more than 11,000 people (Shaposhnikov 2014). In addition to death, several studies have shown a wide range of human health implications associated with overheating ranging from decreased cognitive function (Seppanen 2006), sleep disturbance (Van Loenhout 2016), cardiovascular and respiratory issues (Uejio 2016), and heat stroke. Those likely to be affected by excessive heat events are already the most vulnerable members of society, including “the elderly, infants, the homeless, the poor and people who are socially isolated” (SOEM 2018).

While numerous studies have shown that there is an increase in mortality and morbidity when temperatures exceed the 95th percentile of the historic averages (Gosling 2008, Sheridan 2015), heat related mortality and morbidity has decreased overall over the past century (Sheridan 2018), with mortality rates in the United States (US) decreasing 70% (Barreca 2016). This decrease is likely due to a variety of factors including improved living standards (Tan 2007, Astrom 2013), improved economic status (Ng 2016), and heat warning systems (Ebi 2004, Schifano 2012).

There are mixed findings on the large-scale efficacy of air conditioning on improving health outcomes during excessive heat events. Many studies have found a decrease in heat related mortality with increased prevalence of air conditioning (Zhang 2016, Medina-Ramón 2012, O’Neil 2005). Other studies, however, found no significant effect of air conditioning on health complications related to overheating (Heo 2016, Ng 2016), partially due to the fact that the cost of obtaining and running air conditioning prevents access to the poor and marginalized groups (Smoyer 1998). As the climate warms, the use of air conditioning could increase tenfold by 2050 (Cox 2012). Increased air conditioning will further catalyze warmer temperatures in two ways: 1) from an increase in carbon emissions, and 2) from the direct heat byproduct expelled to the outdoors through the process of conditioning a space (Lundgren 2013).

Unfortunately, many studies have warned that the health impacts of excessive heat events will likely rise as the intensity and duration of excessive heat events increase (Sheridan 2018), with one study projecting an increase in heat-related mortality of 129% (Muthers 2010). Since the elderly are more at risk during excessive heat events, an aging population will also increase risk of vulnerability (Sheridan 2015, Hajat 2014).

1.2 Seattle Vulnerability to Excessive Heat Events

Seattle has a historically mild summer climate. June, July, August, and September are the hottest months in Seattle, with average highs of 21.7°C (71.1°F), 25.2°C (77.4°F), 25.3°C (77.6°F), 22.0°C (71.6°F) respectively (NOAA 2021). Because of these relatively low historic summer temperatures, Seattle is especially vulnerable to excessive heat events, with adverse health effects starting around 25.8°C (78.6°F) (SOEM 2018). One study found that during excessive heat events, there is an 8% increase in Basic Life Support calls and 14% increase in Advanced Life Support calls (Calkins 2016). Another study found a 10% increase in the death rate and 2% increase to hospital admissions during excessive heat events (Isaksen 2016). While the elderly were primarily at risk in both studies, these studies also found that young to middle-age adults had increased risk of diabetes-related mortality, kidney disorders, acute renal failure, and asthma during excessive heat events (Calkins 2016, Isaksen 2016).

Excessive heat events are projected to become more common in Seattle, with average temperatures predicted to rise 6.5°F by 2050. Seattle's summer temperatures are already rising drastically, with three out of the four hottest days on record happening in 2021, with the highest recorded temperature reaching 42.2°C (108°F) on June 28, 2021 (Wu 2021). A report done by the Washington State Climate Change Impact Assessment compared historic (1980-2006) to projected heat events in the Seattle region, and found that by 2085, there could be up to 10.1 excessive heat events (compared to 2.2 historically) with a maximum duration of 57 days (compared to 6 days historically) (CIG 2009). As temperatures increase, a "moderate" summer in 2045 is expected to cause more than 150 deaths in Seattle (Jackson 2010), compared with 3 to 4 during average summers historically (SOEM 2018).

While air conditioning in Seattle is not widespread in residential buildings, it is becoming increasingly common. While increased adoption of air condition could mitigate the health effects of excessive heat events, the City of Seattle issued a report that states that if air conditioning energy consumption in Seattle increased to 75%, the energy grid could become overwhelmed and cause power outages (SOEM 2018). An increase in energy use will also increase the amount of CO₂ being emitted, thus contributing to a negative cycle of increasing temperatures, and the need for more and more cooling (Cox 2012).

1.3 External Shading and Natural Ventilation for Excessive Heat Event Mitigation in Seattle

This study addresses the need for mitigation strategies in excessive heat events for vulnerable Seattle residents through passive means (without mechanical cooling). The study focuses on passive strategies for the following reasons: 1) to decrease dependence on air conditioning and the associated burning of fossil fuels, 2) to prevent utility cost burden of operating air conditioning for poor residents, 3) to protect energy grid and improve the buildings' resilience in the case of a power outage, and 4) where air-conditioning is necessary, reducing the size and energy use of the equipment through a layered passive/active approach. We focus our study on assessing two passive cooling design approaches: 1) external shading devices, and 2) natural ventilation modes for passive cooling.

While external shading devices have been widely recognized in reducing solar heat gain, improving thermal comfort, and reducing cooling loads in hot climates (Al-Tamimi 2011, Garcia-Nevado 2020, Chen 2015, Chan 2010), there is little research studying their efficacy in relatively mild climates such as Seattle. Similarly, there are many studies that show the efficacy of natural ventilation (ie opening windows to bring outside air into a space) in reducing mechanical cooling load and improving thermal comfort (Kolokotroni 1999, Gratia 2004, Schulze 2013). However, there is little research on the efficacy of natural ventilation on improving thermal comfort in mild climates.

2.0 METHODS

We performed a series of energy simulations to assess the impact of shading devices and natural ventilation on thermal comfort during summer (June 21st to September 21st) in Seattle, Washington for a generic mid-rise, multi-family residential apartment unit. Energy models were created using Rhino 7, Grasshopper, Ladybug Tools 1.2.0, and OpenStudio 3.1.0. Energy simulations were performed through EnergyPlus 9.5.0. The following sections outline the simulation inputs, simulation outputs, and our methodology for assessing the results.

2.1 Simulation Inputs

We built a variety of simulation cases (ie unique energy models) by holding certain energy model inputs constant (Table 1) and varying other input variables (Table 2). We ran energy simulations for all possible combination of inputs from Table 2.

Table 1: Constant Simulation Inputs

<i>Fixed Inputs</i>	<i>Values</i>	<i>Additional Description</i>
Simulation Duration	June 21 st – September 21 st	Meteorological Summer
Simulation Time-step	10 minutes	Frequency of energy calculations in simulation
Massing	DOE Reference Model	See description in Section 2.1
Orientation	West	See description in Section 2.1
Mechanical Cooling	No	
People Loads	Max Density = 0.028 people/m ²	Max density and schedule per DOE reference model
Lighting Loads	Max Density = 11.5 W/m ²	Max density and schedule per DOE reference model
Equipment Loads	Max Density = 6.7 W/m ²	Max density and schedule per DOE reference model
Mechanical Heating Setpoint	65 °F	See description in Section 2.1
Window-to-wall ratio (WWR)	20%	See description in Section 2.1
Apartment Level	Mid-level	See Figure 1

Table 2: Variable simulation inputs. Simulation cases reflect permutations of all simulation inputs.

<i>Variable Inputs</i>	<i>Values</i>	<i>Additional Description</i>
Weather File	Seattle TMY2 Seattle A1FI project year 2050	See description in Section 2.1
Exterior Shading Devices	No exterior shading Half exterior shading 3/4 exterior shading	See description in Section 2.1
Infiltration	0.35 Air Changes per Hour (ACH) 0.5 ACH	Typical for tight construction (Grondzik 2014) Typical for medium construction (Grondzik 2014)
Construction	2004 Construction 2015 Construction	See Table 3 for assembly details See Table 3 for assembly details
U-Factor Window	0.35 Btu/h·ft ² ·F 0.15 Btu/h·ft ² ·F	Typical for double pane windows Typical for triple pane windows
Natural Ventilation	None Windows always open Optimal natural ventilation	See description in section 2.1

Below is an expanded description for several of the input variables:

Weather File

Two weather files were used for Seattle, WA: 1) a TMY2 weather file (EnergyPlus 2021) and 2) a projected weather file for 2050 to assess the impact of our warming climate. The 2050 projected weather file was generated using an online tool published by Jiang et al (Jiang 2019). The Intergovernmental Panel on Climate Change’s (IPCC) A1FI emission scenario was used to generate the weather file. A1FI is the worst-case emission scenario projected by the IPCC, and assumes rapid economic growth that is dependent on fossil fuels. Unfortunately, this worst-case scenario is increasingly likely, and it projects a 6.4 °C rise in global average surface temperatures by 2100 (IPCC 2014).

Basis of Design

The US Department of Energy reference buildings for new construction are prototype building models that are used by the DOE and the Pacific Northwest National Laboratory (PNNL) for assessing energy savings associated with energy codes. The DOE midrise apartment reference building for Seattle was used as the basis of design for the massing, programmatic loads, and the wall and roof assemblies (DOE 2021).

The massing of the mid-level residential apartment unit (Figure 1) was derived from a typical rectangular unit from the DOE mid-size multifamily reference model with one exterior facade surface and three interior walls (ie an apartment unit sandwiched between two adjacent units and a corridor). We ran simulations a 20% window-to-wall (WWR), which approximates the WWR in the DOE reference unit. The apartment units are oriented towards the west in the simulations (ie the exterior façade is west facing), because west-facing facades receive the most solar radiation during the summer in Seattle (IDL 2012).

We also used two different construction assemblies: 1) Exterior wall and roof assemblies per the 2015 International Energy Conservation Code (IECC) and 2) Exterior wall and roof assemblies per the 1980-2004 Commercial Buildings Energy Consumption Survey (CBECS). See Table 3 for details regarding assemblies modeled.

External shading devices

Solar heat gain coefficient (SHGC) of the glazing was used as a proxy for modeling external shading devices. A baseline SHGC of 0.4 was used to model typical glazing performance, which aligns with the baseline value for simulating energy savings per the 2018 Washington State Energy code (source). We had three external shading device scenarios: 1) No external shading devices (ie SHGC = 0.4), 2) External shading devices that reduce SHGC by 50% (ie SHGC = 0.2), which we call “half exterior shading”, and 3) External shading devices that reduce SHGC by 75% (ie SHGC = 0.1), which we call “3/4 exterior shading”.

Natural Ventilation

We ran simulations with three different options for natural ventilation. The first option was with no natural ventilation, representing a resident that does not open windows due to privacy concerns, windows painted shut, an occupant physically unable to open windows, or other reasons; or a situation where the windows are fixed. The second natural ventilation type was having the windows open during the entire simulation, characterized as a user who seeks relief, but is incapable or unaware of operating windows to maximize passive cooling. The third type was having window open at all times except when outdoor temperatures were 1 °F or higher than indoor temperatures. Windows were simulated to open at 50% of the window area, with a 0.45 discharge coefficient, and no cross-ventilation.

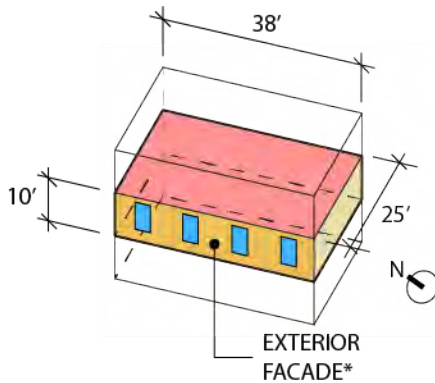

Figure 1: Massing of mid-level apartment used in energy simulation. *All apartment surfaces are adiabatic (meaning they have the same temperatures on either side of the surface throughout the simulation) except the exterior façade shown.

Table 3: Construction Assembly Parameters

Assembly	R-Value Assembly	Assembly Materials
2015 Construction Wall (Basis: IECC 2015)	17.2 h·ft ² ·F/Btu	25mm Stucco 5/8 in. Gypsum Board Typical Insulation-R15 5/8 in. Gypsum Board
2004 Construction Wall (Basis: 1980-2004 CBECS)	12.3 h·ft ² ·F/Btu	25mm Stucco 5/8 in. Gypsum Board Typical Insulation-R10 5/8 in. Gypsum Board

2.2 Simulation Outputs

Heat Index

Hourly interior air temperature and relative humidity were calculated for each simulation. At the end of each simulation, the heat index for each hour of the simulation was calculated. The Heat Index is a metric used by the National Oceanic and Atmospheric Administration (NOAA) in the US to communicate what ambient conditions feel like to the human body and associated health risks, expressed °C or °F. Heat Index is calculated with relative humidity and dry-bulb temperature, and assumes level of clothing, air movement, and no direct sun. Due to the inverse relationship between evaporation of sweat from the body and moisture content in the air, humans feel warmer in more humid environments, resulting in a heat index that is higher than the ambient dry-bulb temperature. The opposite is true in environments with a low moisture content, resulting in a heat index that is lower than the ambient dry-bulb temperature. Table 4 shows the classifications of Heat Indices and their varying effects on the human body, with negative effects beginning at 80 °F.

Table 4: Heat Index Effects on the Body (NOAA 2021)

Classification	Heat Index	Effect on the body
Caution	80°F - 90°F (26.7°C – 32.2°C)	Fatigue possible with prolonged exposure and/or physical activity
Extreme Caution	90°F - 103°F (32.2°C – 39.4°C)	Heat stroke, heat cramps, or heat exhaustion possible with prolonged exposure and/or physical activity
Danger	103°F - 124°F (39.4°C – 51.1°C)	Heat cramps or heat exhaustion likely, and heat stroke possible with prolonged exposure and/or physical activity
Extreme Danger	125°F or higher (>51.1°C)	Heat stroke highly likely

Recorded Outcome Variables

Two outcome variables were recorded for each simulation case: 1) the maximum heat index reached inside the apartment unit for the entire duration (June 21st – September 21st) of the simulation, and 2) the number of hours during the simulation that the heat index fell into the four heat index classification categories described in Table 4 (caution, extreme caution, danger, extreme danger).

3.0 RESULTS

We ran a total of 144 energy simulations with unique combinations for all of the variable parameters outlined in Table 2. The analysis period for the energy simulation was from midnight on June 21st to midnight on September 21st, which represents 2,232 hours. The following sections outline the key takeaways from the simulation results.

3.1 Outdoor Heat Index Differences between Weather Files

There are significant differences in outdoor heat indices between the historic and 2050 projection weather files for Seattle. Figure 2 shows the range of hourly outdoor heat indices for June through September for both weather scenarios. The outdoor heat indices for the TMY2 weather file go into the caution zone for ten and five hours in July and August and go into the extreme caution zone for four hours in September. The 2050 projection weather file, however, has monthly high heat indices that are 8°F, 13°F, 12°F, and 11°F higher than the historic scenario in June, July, August, and September, with a total of 16, 114, 106, and 54 hours in caution and 0, 29, 8, and 23 hours in the extreme caution zones respectively.

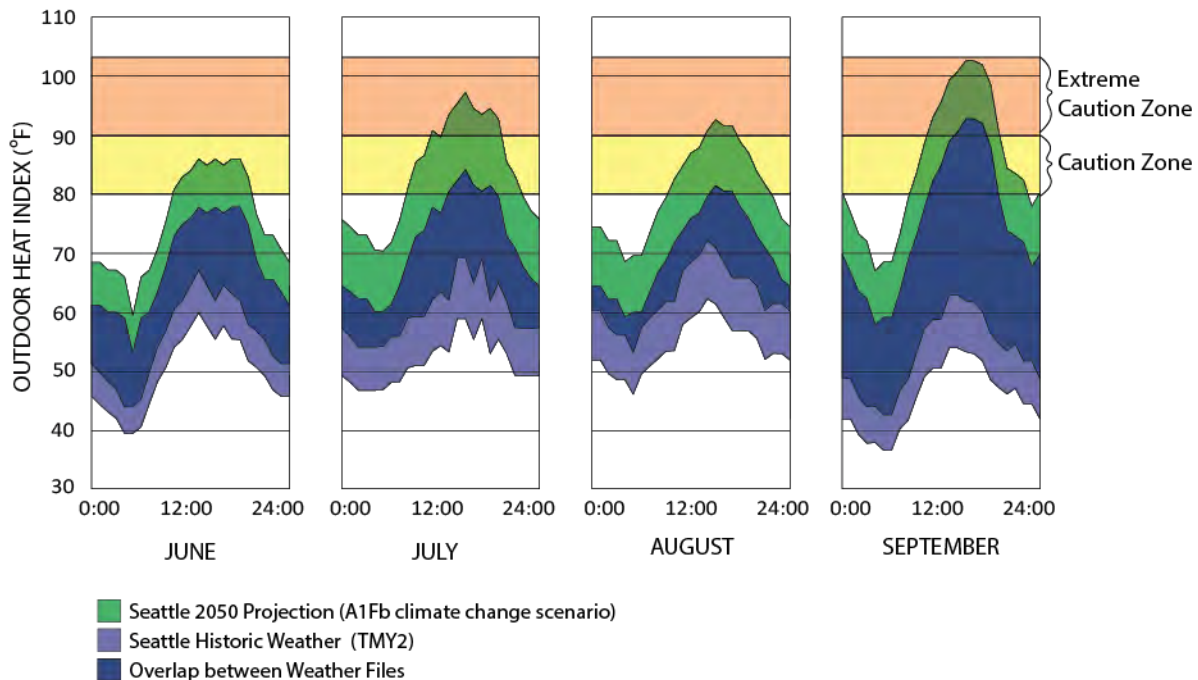

Figure 2: The range of hourly heat indices for June through September for Seattle TMY2 and 2050 projection weather files.

3.2 Weather and Natural Ventilation Impacts on Indoor Heat Index

To assess the performance of all simulation cases, the max indoor heat index during the analysis period and the amount of time the indoor heat index was above 80°F (i.e. above the Caution Zone classification per NOAA) were plotted on a for each simulation case. As shown Figure 3, two variables significantly impact the indoor heat index: 1) the natural ventilation strategy and 2) the weather scenario.

The natural ventilation strategy had the most impact on indoor heat index for all simulations. The best performing ventilation strategy was, by far, having the windows optimally open (ie windows that remain open except when outdoor temperatures are 1°F or warmer than indoor temperatures). For the historic weather file, the average max indoor heat index of the simulations was 78°F, 87°F, and 93°F for windows optimally open, windows always open, and windows always closed respectively. In terms of the duration of time that the indoor temperature was above the caution zone (80°F), there was not a significant difference between windows optimally open versus windows always open (0 hours versus 13 hours on average). Keeping windows closed, however, had a substantial impact on the duration of time indoor heat index was above 80°F, with average time at 1,945 hours with the historic weather file.

One interesting observation is the large spread of indoor heat indices when the windows are always closed and when they are optimally open, suggesting that the other simulation parameters are significantly impacting the indoor heat indices. However, within simulations where the windows are always open, there is not a large spread of indoor heat indices, suggesting that the indoor heat index in that scenario is matching the outdoor heat index and the other parameters are not making a significant impact.

The 2050 projected weather file for Seattle using the A1FI emission scenario significantly increased indoor heat indices for all simulations. On average, the projected weather file increased the max heat index by 9°F for all simulations, pushing all of the max heat indices above 80°F. The duration of time the indoor heat index is above 80°F also significantly increases, with the average duration at 146 hours (+100% compared with historic), 305 hours (+96% compared with historic), and 2232 (max) hours (+13% compared with historic), for windows optimally open, windows always open, and windows always closed respectively.

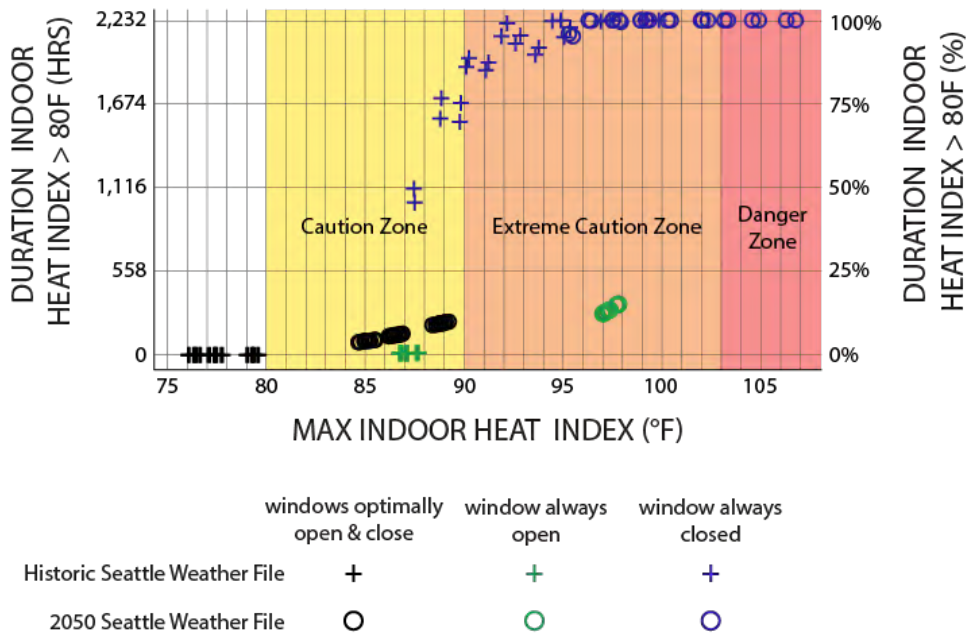

Figure 3: This chart shows the maximum indoor heat index during the entire simulation period (x-axis) and the duration of time (expressed in hours and % of time) during the entire simulation period (June 21st to September 21st) that the indoor heat index was above 80°F (y-axis) for all simulations (144 simulations total). Simulation results are labelled by natural ventilation strategy and weather file. The NOAA categories for heat index are superimposed to show categorization of max heat index (i.e. if max heat index falls in caution zone, extreme caution zone, or danger zone).

3.3 Façade Characteristics Impact on Indoor Heat Index

In an effort to understand the façade characteristics impact on indoor heat index, we assessed analysis results for all simulations that had optimal natural ventilation with the 2050 Seattle weather projection file. Figure 4 shows the max indoor heat index and duration indoor heat index is greater than 80°F for these simulations, plotted with four simulation parameters: 1) exterior shading, 2) infiltration rate, 3) envelope construction, and 4) window insulation type.

Out of the four parameters, exterior shading of windows (using SHGC as an analysis mechanism), had the largest impact on both maximum indoor heat index and the duration of time that the indoor heat index is great than 80°F. Going from no exterior shading to 3/4 exterior shading (i.e. decreasing SHGC from 0.4 to 0.1) reduced the amount of time the indoor heat index was above 80°F by over 50%. Interestingly, there seems to be a rate of diminishing returns when adding exterior shading, with the largest drop in indoor heat index occurring when adding half exterior shading from no exterior shading. For example, going from no exterior shading to half exterior shading reduces the total time the indoor heat index is above 80°F by 37%, but going from half exterior shading to 3/4 exterior shading reduces the total time the indoor heat index is above 80°F by 29% (Figure 4).

Increasing the insulation of the wall, decreasing the infiltration rate of the building envelope, and increasing the insulation of the windows modestly reduces indoor heat indices as well. The greatest impact comes from the three changes is increasing the insulation of the wall. The mechanism for this change is presumably preventing heat gains through conduction through the wall envelope. The window insulation had the least significant impact on indoor heat index. Since the WWR was relatively low (20%), the low impact may be a direct relationship between the relatively low area of glazing to wall. Presumably increasing the WWR would also significantly impact the effect of changing the SHGC on the indoor heat gain as well.

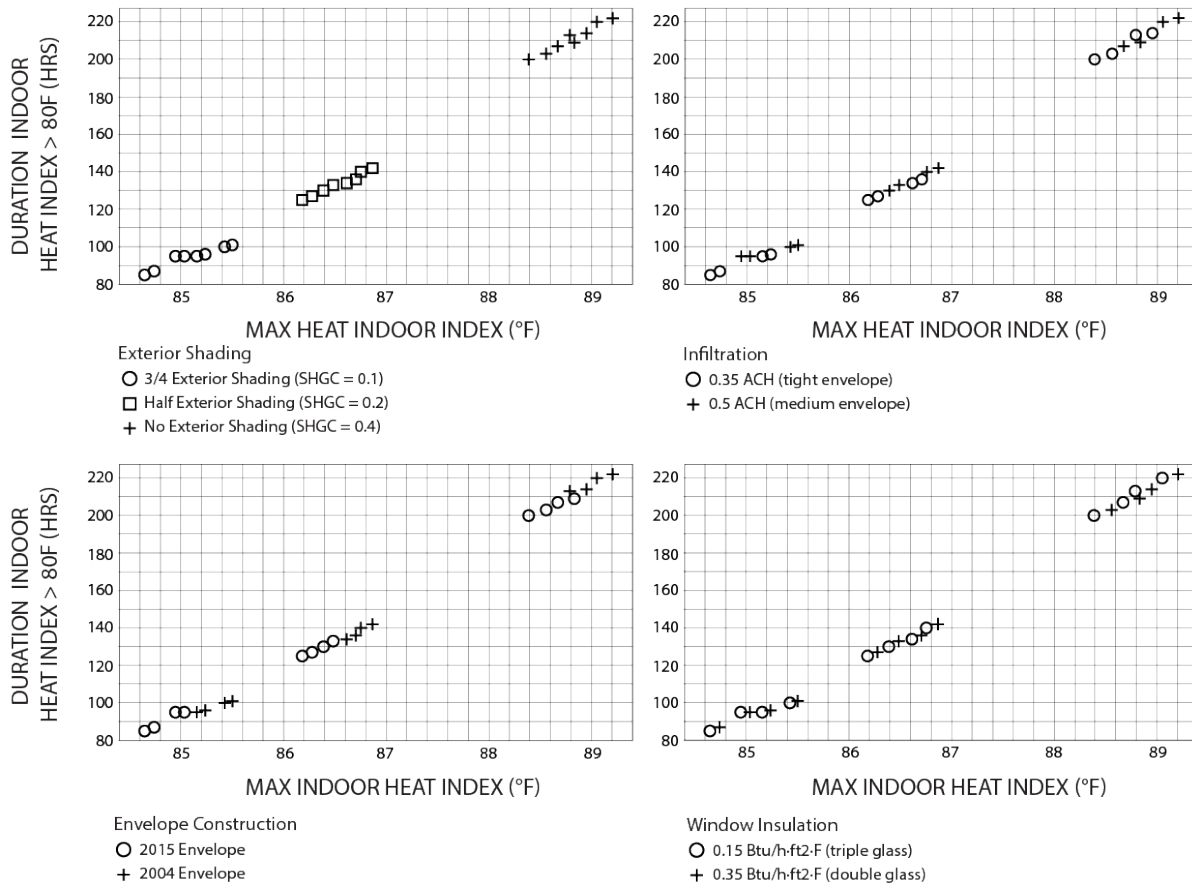

Figure 4: These series of charts show the maximum indoor heat index during the entire simulation period (x-axis) and the number of hours during the entire simulation period that the indoor heat index was above 80°F (y-axis) for all simulations with optimal natural ventilation and the 2050 Seattle weather file (24 simulations total). The four inputs used to generate the simulations results are labelled: 1) SHGC, 2) Infiltration rate, 3) Envelope Construction, and 4) Window Insulation

4.0 DISCUSSION

This study shows how indoor heat indices for west facing apartment buildings can get dangerously high, even in a mild climate like Seattle. Our findings demonstrate how during historical Seattle weather, a typical west facing apartment within windows that remain closed has interior heat indices that have a negative impact on human health at least 48% of the summer. All simulations that we assess for the 2050 weather scenario had 80 to 2,232 hours in the caution, extreme caution, or danger heat index zones, suggesting that air conditioning or another intervention would be required to mitigate serious harm in these scenarios.

While air conditioning could be used as a mitigation strategy, air conditioning has several limitations, mainly: 1) the cost burden of purchasing and operating air conditioning for low-income residents and 2) the contribution of air conditioning to greenhouse gas emissions, and potential grid instability. Furthermore, in some buildings the installation of active cooling is limited by cost, technical barriers of installation, and electrical service capacity. Furthermore, a shortage of available housing units precludes taking older, historically affordable residential units out of service – especially for low-income residents and seniors. In these cases, passive cooling strategies can be used to blunt the impact of heat events while building owners and municipalities identify resources to deploy long-term strategies to adapt to a changing climate.

Our study shows that in the absence of air conditioning, there are several other mitigation strategies available to reduce internal heat indices. The most effective strategy is to open windows at optimal times (ie when the outdoor temperature is not above the indoor temperature). There may be many factors preventing residents to operate their windows in this way, including: it may be practically difficult if residents are not at home, residents may not know when they should open windows for optimal performance, windows may be inoperable, and occupants may prefer to close windows at times for security or outdoor pollution (ie wildfire smoke), which is increasingly prevalent during summer in the western US (Liu 2021). Since bringing outdoor air into a space during optimal times is such an effective strategy, the impact on indoor heat index of mechanically bringing outdoor air into a space for cooling needs to be investigated as a low energy, high impact strategy.

External shading also significantly reduced indoor heat indices in all of the tested scenarios. External shading devices also have limitations, including ease of use (if operable) and cost. While external shading can significantly reduce the indoor heat index, they would need to be paired with an effective natural ventilation strategy to make the largest impact.

In many instances, especially where optimizing natural ventilation is not an option, air conditioning will be required to prevent detrimentally health impacts of overheating in a typical west facing apartment unit. Future study should assess how pairing passive strategies outlined in this paper with cooling could maintain comfortable indoor temperatures, while minimizing the energy burden of air-conditioning. As more residential housing inevitably gets more air conditioning, analysis on how to reduce cooling loads dovetails with the City of Seattle's priority of reducing loads and maintaining integrity of the grid.

5.0 CONCLUSION

Excessive heat events can cause serious health impacts, especially in a historically mild climate like Seattle that is not as prepared for the impact of higher temperatures. As our climate warms, we must rethink our housing stock to prevent morbidity and mortality in the summer, especially for our most vulnerable residents that do not have access to air conditioning. Our study describes a methodology for practitioners to assess health impacts of excessive heat events in housing without air conditioning. We also demonstrate how a multi-variable simulation analysis can be used to test effectiveness of different design or retrofit strategies improving thermal comfort during excessive heat. Our study finds that natural ventilation and external shading can significantly reduce indoor heat indices for a west facing apartment unit in Seattle. Policies, incentives, and education promoting these mitigation strategies should be adopted in the City of Seattle. In many cases, air conditioning may be required to prevent indoor heat indices getting uncomfortably and dangerously high. Future study is needed to assess how passive design strategies could reduce both indoor heat indices and cooling loads for a variety of housing conditions in Seattle.

REFERENCES

- Al-Tamimi, N., & Fadzil, S. (2011). The Potential of Shading Devices for Temperature Reduction in High-Rise Residential Buildings in the Tropics. *Procedia Engineering*, 21, 273-282.
- Astrom, D., Forsberg, B., Edvinsson, S., & Rocklov, J. (2013). Acute Fatal Effects of Short-Lasting Extreme Temperatures in Stockholm, Sweden: Evidence Across a Century of Change. *Epidemiology (Cambridge, Mass.)*, 24(6), 820-829.
- Barreca, A., Clay, K., Deschenes, O., Greenstone, M., & Shapiro, J. (2016). Adapting to Climate Change: The Remarkable Decline in the US Temperature-Mortality Relationship over the Twentieth Century. *The Journal of Political Economy*, 124(1), 105-159.
- Calkins, M., Isaksen, T., Stubbs, B., Yost, M., & Fenske, R. (2016). Impacts of extreme heat on emergency medical service calls in King County, Washington, 2007-2012: Relative risk and time series analyses of basic and advanced life support. *Environmental Health*, 15(1), 13.
- Chan, A., & Chow, T. (2010). Investigation on energy performance and energy payback period of application of balcony for residential apartment in Hong Kong. *Energy and Buildings*, 42(12), 2400-2405.
- Chen, X., Yang, H., & Lu, L. (2015). A comprehensive review on passive design approaches in green building rating tools. *Renewable & Sustainable Energy Reviews*, 50, 1425-1436.
- Climate Impacts Group (CIG), 2009. The Washington Climate Change Impacts Assessment, M. McGuire Elsner, J. Littell, and L. Whitely Binder (eds). Center for Science in the Earth System, Joint Institute for the Study of the Atmosphere and Oceans, University of Washington, Seattle, Washington.
- Cox S. 2012. Cooling a warming planet: a global air conditioning surge. *Yale Environment 360*, Features section. 10 July 2012. http://e360.yale.edu/features/cooling_a_warming_planet_a_global_air_conditioning_surge
- Department of Energy (DOE). 2021 Commercial Reference Buildings. Retrieved from <https://www.energy.gov/eere/buildings/commercial-reference-buildings>
- Ebi, K., Teisberg, T., Kalkstein, L., Robinson, L., & Weiher, R. (2004). HEAT WATCH/WARNING SYSTEMS SAVE LIVES. *Bulletin of the American Meteorological Society*, 85(8), 1067-1073.
- EnergyPlus. Accessed 2021. Weather Data by Location - Seattle-Tacoma 727930. Retrieved from: https://energyplus.net/weather-location/north_and_central_america_wmo_region_4/USA/WA/USA_WA_Seattle-Tacoma.727930_TMY2
- Garcia-Nevado, E., Beckers, B., & Coch, H. (2020). ASSESSING THE COOLING EFFECT OF URBAN TEXTILE SHADING DEVICES THROUGH TIME-LAPSE THERMOGRAPHY. *Sustainable Cities and Society*, 63, 102458.
- Gosling, S., Lowe, J., McGregor, G., Pelling, M., & Malamud, B. (2008). Associations between elevated atmospheric temperature and human mortality: A critical review of the literature. *Climatic Change*, 92(3-4), 299-341.
- Gratia, E., Bruyère, I., & De Herde, A. (2004). How to use natural ventilation to cool narrow office buildings. *Building and Environment*, 39(10), 1157-1170.
- Grondzik, W., & Kwok, Alison G. (2014). *Mechanical and electrical equipment for buildings* (12E. ed.). Hoboken, New Jersey: Wiley.
- Hajat, S., Vardoulakis, S., Heaviside, C., & Eggen, B. (2014). Climate change effects on human health: Projections of temperature-related mortality for the UK during the 2020s, 2050s and 2080s. *Journal of Epidemiology and Community Health* (1979), 68(7), 641-648.
- Heo, S., Lee, E., Kwon, B., Lee, S., Jo, K., & Kim, J. (2016). Long-term changes in the heat-mortality relationship according to heterogeneous regional climate: A time-series study in South Korea. *BMJ Open*, 6(8), E011786.
- Integrated Design Lab (IDL). 2012. Targeting 100! Patient room peak solar loads. Retrieved from: http://t100.be.uw.edu/LOA_PZN_S.php
- IPCC, 2014: Climate Change 2014: Synthesis Report. Contribution of Working Groups I, II and III to the Fifth Assessment Report of the Intergovernmental Panel on Climate Change [Core Writing Team, R.K. Pachauri and L.A. Meyer (eds.)]. IPCC, Geneva, Switzerland, 151 pp.

RESILIENT CITY

Physical, Social, and Economic Perspectives

- Isaksen, T., Fenske, R., Hom, E., Ren, Y., Lyons, H., & Yost, M. (2016). Increased mortality associated with extreme-heat exposure in King County, Washington, 1980–2010. *International Journal of Biometeorology*, 60(1), 85-98.
- Jackson, J., Yost, M., Karr, C., Fitzpatrick, C., Lamb, B., Chung, S., . . . Fenske, R. (2010). Public health impacts of climate change in Washington State: Projected mortality risks due to heat events and air pollution. *Climatic Change*, 102(1-2), 159-186.
- Jiang, A., Liu, X., Czarniecki, E., & Zhang, C. (2019). Hourly weather data projection due to climate change for impact assessment on building and infrastructure. *Sustainable Cities and Society*, 50, 101688.
- Kolokotroni, M., & Aronis, A. (1999). Cooling-energy reduction in air-conditioned offices by using night ventilation. *Applied Energy*, 63(4), 241-253.
- Liu, Y., Austin, E., Xiang, J., Gould, T., Larson, T., & Seto, E. (2021). Health Impact Assessment of the 2020 Washington State Wildfire Smoke Episode: Excess Health Burden Attributable to Increased PM2.5 Exposures and Potential Exposure Reductions. *Geohealth*, 5(5), E2020GH000359-N/a.
- Lundgren, K., & Kjellstrom, T. (2013). Sustainability Challenges from Climate Change and Air Conditioning Use in Urban Areas. *Sustainability (Basel, Switzerland)*, 5(7), 3116-3128.
- Medina-Ramón, M., & Schwartz, J. (2007). Temperature, temperature extremes, and mortality: A study of acclimatisation and effect modification in 50 US cities. *Occupational and Environmental Medicine (London, England)*, 64(12), 827-833.
- Muthers, S., Matzarakis, A., & Koch, E. (2010). Climate Change and Mortality in Vienna-A Human Biometeorological Analysis Based on Regional Climate Modeling. *International Journal of Environmental Research and Public Health*, 7(7), 2965-2977.
- National Oceanic and Atmospheric Administration (NOAA). 2021. Retrieved from: <https://www.weather.gov/ama/heatindex>
- Ng, C., Boeckmann, M., Ueda, K., Zeeb, H., Nitta, H., Watanabe, C., & Honda, Y. (2016). Heat-related mortality: Effect modification and adaptation in Japan from 1972 to 2010. *Global Environmental Change*, 39, 234-243.
- NowData - NOAA Online Weather Data. 2021. National Oceanic and Atmospheric Administration.
- O'Neill, M., Zanobetti, A., & Schwartz, J. (2005). Disparities by race in heat-related mortality in four US cities: The role of air conditioning prevalence. *Journal of Urban Health*, 82(2), 191-197.
- Schifano, P., Leone, M., De Sario, M., De'Donato, F., Bargagli, A., D'Ippoliti, D., . . . Michelozzi, P. (2012). Changes in the effects of heat on mortality among the elderly from 1998-2010: Results from a multicenter time series study in Italy. *Environmental Health*, 11(1), 58.
- Schulze, T., & Eicker, U. (2013). Controlled natural ventilation for energy efficient buildings. *Energy and Buildings*, 56, 221-232.
- Seattle Office of Emergency Management (SOEM). 2018. Seattle Hazard Identification and Vulnerability Analysis. City of Seattle
- Seppanen, O., Fisk, W.J., Lei, Q.H. (2006) "Room temperature and productivity in office work" Lawrence Berkeley National Laboratory
- Shaposhnikov, D., Revich, B., Bellander, T., Bedada, G., Bottai, M., Kharkova, T., . . . Pershagen, G. (2014). Mortality Related to Air Pollution with the Moscow Heat Wave and Wildfire of 2010. *Epidemiology (Cambridge, Mass.)*, 25(3), 359-364.
- Sheridan, S., & Allen, M. (2015). Changes in the Frequency and Intensity of Extreme Temperature Events and Human Health Concerns. *Current Climate Change Reports*, 1(3), 155-162.
- Sheridan, S., & Allen, M. (2018). Temporal trends in human vulnerability to excessive heat. *Environmental Research Letters*, 13(4), 43001.
- Smoyer, K. (1998). A comparative analysis of heat waves and associated mortality in St. Louis, Missouri – 1980 and 1995. *International Journal of Biometeorology*, 42(1), 44-50.
- Tan, J., Zheng, Y., Song, G., Kalkstein, L., Kalkstein, A., & Tang, X. (2007). Heat wave impacts on mortality in Shanghai, 1998 and 2003. *International Journal of Biometeorology*, 51(3), 193-200.
- Uejio, C., Tamerius, J., Vredenburg, J., Asaeda, G., Isaacs, D., Braun, J., . . . Freese, J. (2016). Summer indoor heat exposure and respiratory and cardiovascular distress calls in New York City, NY, U.S. *Indoor Air*, 26(4), 594-604.
- Van Loenhout, J., Le Grand, A., Duijm, F., Greven, F., Vink, N., Hoek, G., & Zuurbier, M. (2016). The effect of high indoor temperatures on self-perceived health of elderly persons. *Environmental Research*, 146, 27-34.
- Wu, Daniel. "3 Of Seattle's 4 Hottest Days on Record Just Happened." *The Seattle Times*, The Seattle Times Company, 29 June 2021, <https://www.seattletimes.com/seattle-news/3-of-seattles-4-hottest-days-on-record-just-happened/>.
- Zhang, Y., Nitschke, M., Krackowizer, A., Dear, K., Pisaniello, D., Weinstein, P., . . . Bi, P. (2016). Risk factors for deaths during the 2009 heat wave in Adelaide, Australia: A matched case-control study. *International Journal of Biometeorology*, 61(1), 35-47.

Modernity and Human Health: The Connection to Outdoor Air

Elizabeth L. McCormick^{1,2}, Traci R. Rider²

¹University of North Carolina at Charlotte, Charlotte, NC

²North Carolina State University, Raleigh, NC

ABSTRACT: According to a report from the US EPA, Americans spend 90% of their time in environments where concentrations of contaminants can be five times higher than typical outdoor levels: *inside buildings* (US EPA 2017). Advances in mechanical technologies and air-conditioning market penetration have supported global trends toward sealed, conditioned buildings, regardless of climate, health, culture or local identity. Aside from the inherent health implications of indoor air, adopting air conditioning as the primary thermal strategy has given way to a ubiquitous placelessness among modern buildings, an overall detachment from nature, and out-of-control energy consumption, carbon emissions and expansive ecological degradation. Though natural ventilation can be a low-cost alternative to complex mechanical systems, it is often associated with stigmas of poverty and unsophistication. Just as specific building materials and methods became associated with confidence and power, climate control became intimately connected to social status, symbolic of a human victory over nature (Brager and de Dear 2008). This paper highlights historical relationships between human hygiene perceptions, the indoor environment and outdoor air. Beginning with the cultural associations of germs and human behavior over the past two centuries, we explore the open-air hospitals and tuberculosis wards of the 1800s, the sick building syndrome of the 1970s and current research regarding the COVID-19 pandemic. This synthesis research intends to dispel the notion that high-performance, *healthy* buildings must implement sealed, airtight enclosures separating the occupant from the outdoors. Results will counter the modern tendency to employ airtightness as an energy-efficiency strategy in urban, commercial buildings.

KEYWORDS: Natural Ventilation, Indoor Air Quality, Healthy Buildings

INTRODUCTION

The footprint of the interior environment is substantial – physically, psychologically and ecologically. The land area occupied by interior space is nearly equivalent to that of flooded grasslands and tropical forests on planet's surface (Martin et al. 2015). With global building and construction growth rates of 3-5% per year (United Nations Environment Programme 2020), the ratio of built space to natural landscape is increasingly shifting. Once considered an outlier, the built footprint of Manhattan is nearly three times the area of the land that it was built upon; this density is becoming more common in cities around the world (Martin et al. 2015). Not only has the amount of interior space grown, but the ratio of time that humans spend indoors has shifted drastically since the adoption of air conditioning in the 1900s. According to a report from the US EPA, Americans spend 90% of their time indoors (US EPA 2017). This enclosed environment, particularly when controlled entirely by mechanical ventilation, is an ecosystem of its own - with nutrient cycles, biotic life and energy flows - impacting every aspect of the human experience.

Advances in mechanical technologies, paired with air-conditioning market penetration, have supported global trends toward sealed, fully-conditioned buildings, regardless of climate, health, culture or local identity. Aside from the inherent health implications, the adoption of air conditioning as the primary thermal strategy to cool interior space has given way to a ubiquitous placelessness among modern buildings, an overall detachment from nature, and out-of-control energy consumption, carbon emissions and ecological degradation.

Many drivers pushing people indoors are socially and culturally constructed and not based on scientific merit alone. Architectural researcher Kiel Moe suggests that the "relationship between air conditioning and energy use has been determined socially rather than scientifically" (Moe 2007). This literature synthesis unveils historical relationships between human hygiene perceptions, the indoor environment and outdoor air. Beginning with the cultural associations between germs and human behavior over the past two centuries, we explore the open-air hospitals and tuberculosis wards of the 1800s, sick building syndrome associated with the energy movement of the 1970s and current research regarding the COVID-19 pandemic. This paper intends to dispel the notion that high-performance, *healthy* buildings must implement sealed, airtight enclosures that separate the occupant from the outdoors. The COVID-19 pandemic especially has unveiled some of the challenges and limitations of this strategy, suggesting that architects and engineers must reevaluate the benefits of outdoor air and naturally ventilated spaces.

1.0 BACKGROUND & HISTORY

While temperature measurement is a well-established science, the quantification of heat in the context of the human body is a much more recent study. It wasn't until the 1800s when thermal measurements referenced environmental human comfort around heat, light and fresh air (Brager and de Dear 2008). Additionally, there is an ever-evolving relationship between thermal comfort standards and technological developments. Just as specific building materials and methods became associated with confidence and power, climate control became connected to social status, symbolic of a human victory over nature (Brager and de Dear 2008), a concept championed by the modernist movement. When air conditioning was adopted into the American home in the 1960s, for example, it soon became unacceptable for people to sweat or smell of body odor, creating a demand for air conditioning in all interior environments, further separating occupants from the outdoors. As a result, people have developed specific interior thermal comfort expectations, altering their original perceptions of exterior thermal satisfaction (Moe 2010).

Beginning with the control of fire, humans have manipulated nature to address anthropocentric needs, using technology where nature alone would not suffice. Viewed through a deterministic lens, the Industrial Revolution and the development of machines forever changed the human social fabric and relationship with nature. Until this point, humans did not alter the atmosphere's chemical composition at a global level (Crutzen 2002). *Culturally*, this is defined by the domination and commodification of nature, a phenomenon that Environmental Philosopher Freya Mathews calls *anthropocentric triumphalism* (Mathews 2011).

This experience is particularly evident in the human connection to the conditioned indoor environment. In recent history, Western civilization, and largely the United States, has come to address health by leaning on technology (treatment) instead of salutogenic (preventative) measures - like providing fresh outdoor air. Instead, humans often attempt to control disease through medicine with a "pill for every ill" (Dancer and Dancer 2013). Many researchers argue that "the widespread presence of antibiotic resistance in the USA is due to an industry-driven response to a cultural construct: the idea of 'germs'" (Martin et al. 2015). Infection control procedures have not historically involved environmental space; instead, we often rely on infection control strategies.

2.0 CULTURAL ASSOCIATION WITH GERMS & OUTDOOR AIR

To understand buildings are habitually sealed in the first place, the social constructs associated with germs and hygiene must be understood, as well as the sociocultural associations with outdoor air in western cultures. Culturally, conceptions of hygiene and cleanliness have driven our relationship with indoor spaces (Martin et al. 2015), which are often isolated from the nuances of scientific reasoning.

"Tools always presuppose a machine, and the machine is always social before it is technical. There is always a social machine which selects or assigns the technical elements used" (Moe 2007)

2.1 Healthy Germs & the Hygiene Hypothesis

In much of the literature (both fiction and non-fiction), nature is portrayed as *dirty*. Not only does nature and the outdoors often represent uncleanliness, but dirt also signifies disorder, a lack of sophistication, immoral ways of living, and even danger (Douglas 2002) (Dancer and Dancer 2013). However, the human relationship with germs and cleanliness is actually a relatively new construct (Tomes 1998) that stems from social constructs of health and hygiene. During the Renaissance (14-17th century), for example, *etiquette* - not sanitation (or fear of disease) - was the primary driver of hygiene. Spitting and coughing, for example, were prohibited behaviors among those seeking social distinction (Tomes 1998). It wasn't until the development of *Germ Theory* in the late 19th century that scientific reasoning drove public health infrastructure, including municipal sewer systems, waste collection, water safety and food inspection protocols still in use today (Tomes 1998).

2.1.1 Germ Theory

Until the development of microbiology in the mid-19th century, civilizations developed a wide range of theories to explain the transmission of infectious diseases. Though it may seem obvious now that diseases often spread through human contact, humans were mainly living in rural settings until the industrial revolution, with generous access to fresh air. It wasn't until urban populations densified and transmission between humans became more apparent (Blaser 2015).

Instead, the *miasma theory* was the dominant view among scientists and doctors. This belief proposed that what we now identify as communicable diseases were caused by *miasma*, or poisonous vapors found in "bad air" (Karamanou et al. 2012; Krieger 2011). Other diseases were often thought to come from poor dispositions from unhealthy living habits or perceived inferior genetics (Tomes 1998). However, it wasn't until the mid-1800s when scientists learned that diseases were caused by microorganisms, particularly bacteria - forming the underpinnings of germ theory. The widespread acceptance of this hypothesis in Europe and America prompted the *Golden Era* of the public health movement from 1890 to 1930. During this time, scientists made profound advances in vaccine development, surgical techniques, drug discovery and the control of infectious disease (Logan et al. 2019). This period formed tremendous social and behavioral habits that have driven our relationship with health, hygiene, nature and buildings. Most notably, it triggered the notion of a 'gospel of germs' - the belief that disease can be avoided by certain protective behaviors (Tomes 1998). The realization that that diseases could be spread through human transmission, not environmental conditions, appeared to induce a culture of excessive cleanliness and germaphobia that will be discussed below.

2.1.2 Hygiene Hypothesis

In the last half-century, an emergence of research suggests that developed civilizations have become *too clean* and that certain levels of microbial exposure are fundamental to human health (Cirstea et al. 2018) (Greenhough et al. 2018). The *hygiene hypothesis* currently represents one of the most popular explanations for the dramatic increases in childhood illnesses and microbial resistance to antibiotics (Blaser 2015). This theory suggests that the immune system, particularly children's, must be exposed to certain germs to trigger appropriate immune reactions. Dr. Martin J Blaser, director of the Human Microbiome Project at NYU, suggests that our dependence on antibiotics, particularly in children, has dramatically altered the human microbiome, disrupting the relationship between health and the environment.

2.1.3 Historical Precedents

Protective behaviors became increasingly evident in a consumer culture when marketers targeted women, the demographic most concerned with the implications of domestic cleanliness. In addition to caring for the home, women sought to provide a safe, hygienic lifestyles for families. In the 1920s and 30s, self-service grocery stores emerged rapidly in the United States, made possible by refrigeration technologies and one unassuming contributor: cellophane, the disposable, transparent, and 'sanitary' packaging film (Hisano 2017). Not only could the consumer see the product that they were buying, but they also found it 'clean' and untouched by human hands. DuPont, the maker of cellophane, launched an aggressive and expansive marketing campaign geared towards women, "playing upon the germ phobias associated with human touch... more specifically, the 'flies, fingers, and food' trio central to the gospel of germs" (Tomes 1998). DuPont initially targeted consumer products commonly associated with germs and uncleanness, including meat, bread, and tobacco products, before the product became entirely ubiquitous (Hisano 2017). Many other disposable products emerged during the same period, also in pursuit of a more sanitary, germ-free lifestyle. Kleenex, for example, was introduced in 1924 as a cold cream remover. However, when it became used for nose-blowing, the

company quickly adjusted the marketing material toward cleanliness, portraying cloth handkerchiefs as unsanitary and *uncivilized* (Tomes 1998). Again, perceptions of germ-aversion and hygiene promptly became associated with class and sophistication.

However, as germ theory gained popularity in groceries and consumer products, fresh air remained a strategy for sanitation inside buildings. In an 1880 article entitled, *How Typhoid Fever is Conveyed*, T.J. MacLagan explained simply, "keep the windows shut, and you keep the germs in; open them, and they pass out with the changing air" (Tomes 1998). Despite the unpredictable nature of outside air, certain positive health implications remained associated with it. In the late 19th century, Dr. Luther Emmett Holt, an American pediatrician and professor of disease of children in the college of physicians and surgeons at Columbia University, penned a popular parenting book. His book, entitled, *Writing the Care and Feeding of Children: A Catechism for the Use of Mothers and Children's Nurses*, recommended the process of *airing out children* to "renew and purify the blood." Excerpts from Holt's canonical text include:

"Is there not great danger of a young baby's taking cold when aired in this manner? *Not if the period is at first short and the baby accustomed to it gradually. Instead of rendering the child liable to take cold, it is the best means of preventing colds.*"



Figure 1: Everything's at its best in Cellophane, 1956. Source: Hagley Museum and Library, Wilmington, DE 19807

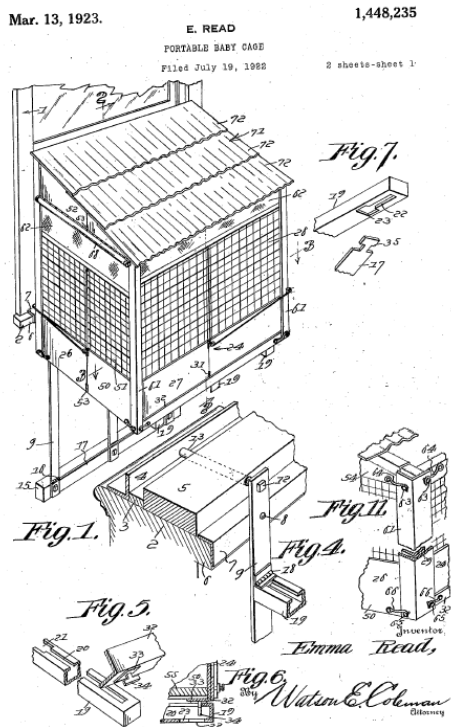

Figure 2: Patent for Portable Baby Cage.
Source: (Read 1923)

“Of what advantage to the child is going out? *Fresh air is required to renew and purify the blood, and this is just as necessary for health and growth as proper food.*

What are the effects produced in infants by fresh air? *The appetite is improved, the digestion is better, the cheeks become red, and all signs of health are seen.*” (Holt 1909).

By providing regular access to fresh air, infants could theoretically build their immune systems to ward off common colds. In 1922, as a solution for people living in cramped apartments who still wanted to air out their child, the baby cage was invented, shown in Figure 2 (Read 1923) (Kushnick 2019). This device, also known as the ‘window crib’ was a small outdoor sleeping compartment attached to apartment windows so that urban babies could still have access to the healing effects of outdoor air (Keyser 2015).

2.2 The pre-antibiotic era: The sanatorium & fresh air cure

Tuberculosis (TB) is one airborne infectious disease that plagued urban populations while simultaneously revolutionizing the human relationship between fresh air and human health before antibiotics. TB killed more people between 1914 and 1918 than the first World War (Damsky 2003). Spread through close contact between humans, the bacteria causing TB had been around for millions of years before it was officially ‘discovered’ in 1882 while killing one out of every seven people in Europe and the United States (CDC 2021). TB is still a leading cause of global morbidity, particularly across the developing world.

In 1840, British physician and pulmonary specialist George Bodington published a study on the treatment and care of pulmonary diseases (1840).

He noted that people who worked outdoors, such as farmers and shepherds, appeared *immune* to Tuberculosis, which was more likely to infect people who spent their time indoors, particularly in urban settings. He reasoned that patients should learn from the lifestyles of outdoor laborers and spend more time breathing fresh outdoor air (Hobday and Cason 2009). This notion was the foundation for *open air therapy* (*open air method*) and the sanatorium movement, as a standard treatment for TB and other infectious diseases until the invention of antibiotics in the 1950s (Hobday 2019).

The sanatorium emerged in Europe as a standard treatment facility for long-term illnesses. The first sanatorium for the treatment of TB was opened in 1863 by Hermann Brehmen in Silesia (now Poland), where patients were exposed to outdoor air, sunlight, and good nutrition (Greenhalgh and Butler 2017). The first American sanatorium opened 21 years later in 1884 at Saranac Lake in New York State. This treatment strategy required patients to leave their homes for long periods of time. This cumbersome strategy was quickly replaced by the convenience of antibiotics, which were far less expensive and disruptive than a stay in a sanatorium. Consequently, “belief in the therapeutic and germicidal properties of outdoor air diminished” (Hobday 2019), despite being an effective treatment strategy. Though fresh air therapy was no longer the primary antidote for infectious diseases, naturally ventilated spaces still serve as a viable approach for health-related facilities, particularly in resource-stricken economies.

3.0 MODERN CONCERNS & THE SHIFT TO MECHANICAL VENTILATION

Growing cultural connections between climate control and social status – as well as advances in mechanical conditioning technologies and access to affordable energy - led to an abrupt transition from natural ventilation to mechanical strategies. Additionally, as people moved into cities at unprecedented rates, more energy-intensive, high-rise buildings were being constructed than ever before. Early office towers, such as the Home Insurance Building in Chicago (1885), used operable windows to provide ventilation, lighting and passive heating. This generation of buildings was bulky and compact with only 20-40% of the façade having glazing, compared to the 50-75% glazed facades of modern buildings today (Oldfield et al. 2009). Less than 50 years later, the first air-conditioned office building, the Milam Building (1928), was completed in San Antonio. From that point on, air conditioning became an expectation of the modern workplace, making a case for sealed buildings that are reliant entirely on mechanical solutions for thermal comfort. Today, heating, cooling and ventilation represent 40% of the energy load in buildings (Graham 2016), with higher demands in hot-humid climates to account for high dehumidification loads.

Until the early 1900s, buildings were designed to *breathe*, though this was often uncontrolled due to the poor construction of buildings and the unpredictable nature of outdoor air. During this time, however, building standards called for at least 15 cubic feet per minute (CFM) of outside air per person, primarily to dilute and remove body odors and smells (EPA 1991). However, the oil crisis of the 1970s heightened environmental concerns around the use of fossil fuels, particularly from foreign sources, prompting a new emphasis on the energy performance of buildings.

Constructed to higher, more airtight standards, energy efficient buildings often limited the use of fresh air to 5 CFM per person to reduce the environmental load associated with mechanical conditioning. Similarly, current international guidelines, including from the American Society of Heating and Refrigerating Engineers (ASHRAE), require a minimum of 15 CFM per person. However, recent studies, including Joseph Allen's Cognitive Function (COGfx) study call for enhanced ventilation offerings of at least 40 CFM per person to maintain minimum standards of indoor environmental health. Airtightness is still one of the key tenets of contemporary energy efficient construction; however, there is an increased emphasis on indoor air quality and ventilation protocols.

3.1 Indoor Air Quality & Occupant Health: Sick Building Syndrome

Despite energy savings, sealed and mechanically ventilated buildings are often plagued with indoor contaminants impacting human health and comfort from a lack of fresh air exchange. Soon after the superinsulation and energy efficiency movement of the 1970s, the World Health Organization (WHO) identified the health problems associated with indoor spaces as *Sick Building Syndrome* (SBS) (1983). SBS is described as a set of physical, chemical and psychological factors affecting human health and comfort, including asthma, allergies, watery eyes, cough, headache and fatigue (Kraus 2016) while more severe ailments can include cardiovascular issues, cancers and reproductive problems (Joshi 2008). Aside from individual health implications, the annual costs associated with productivity losses from SBS in the commercial workplace are estimated to reach up to \$70 billion per year in the United States alone (Awada et al. 2021). "In offices, it was found that sick leaves associated with sick building syndromes dropped by 35% when ventilation rates were increased from 12 L/s [25.4 CFM] to 24 L/s [50.9 CFM]" (Milton et al. 2000).

Rios et al. (2009) studied the air quality in two office buildings in Rio de Janeiro – one airtight (mechanically ventilated) and one naturally ventilated – correlating measured data with survey data from 1,736 office workers. Results demonstrated a significantly higher frequency of upper respiratory symptoms and fatigue in the sealed building with HVAC systems than in the naturally ventilated building. Additionally, the mechanically ventilated building occupants experienced a higher frequency of improved symptoms after leaving the office, which is common with SBS. Interestingly, the researchers measured similar levels of certain pollutants within both buildings. However, occupants of the sealed building had a higher frequency of health concerns and complaints.

3.2 Healthcare-associated infections

Despite significant advances in modern medicine, infectious disease remains a leading cause of death across the globe. Lower respiratory infections, such as bronchitis and pneumonia, are the fourth leading cause of death worldwide (WHO 2020). As previously established, human density can lead to the rapid spread of infectious diseases. This spread is particularly prevalent in health care facilities where susceptible individuals congregate in close quarters controlled by mechanical ventilation (Escombe et al. 2007). Healthcare-associated infections (HAI) still affect 5-15% of hospitalized patients and 9-37% of intensive care unit (ICU) patients, with significantly higher percentages in resource-stricken countries (National Center for Biotechnology Information and U. S. National Library of Medicine 2009).

Escombe et al. (2007), studied eight hospitals in Lima, Peru to explore the difference between natural and mechanical ventilation and the effects of the two on the institutional transmission of airborne infection. This study included five hospitals built pre-1950 and three 'modern' hospitals built between 1970 and 1990. They studied 70 naturally ventilated clinical rooms against 12 mechanically ventilated negative-pressure respiratory isolation rooms within these facilities. Results showed that the risk of airborne contagion was significantly lower in the older, naturally ventilated facilities, particularly those with high ceilings and large windows on more than one wall. On the other hand, the modern buildings under study had a higher risk of infection, particularly in the mechanically ventilated rooms with sealed windows, even while meeting or exceeding local ventilation guidelines. Additionally, the study found that the natural ventilation from open windows was more effective than mechanical ventilation against TB infection, even on days with little wind. "Infection rate compared with 33% in modern and 11% in pre-1950 naturally ventilated facilities with windows and doors open" (Escombe et al. 2007).

3.3 COVID-19 & Indoor Air

Four worldwide influenza outbreaks have occurred in the last 100 years: in 1918 there was H1N1, the Spanish flu, in which 50 million+ people died; 1957 saw H2N2, the Asian Flu; 1968 had H3N2, the Hong Kong Flu; and 2009 had H1N1, the Swine Flu. An ASHRAE report *from 2014* outlined procedures in preparation for a devastating pandemic, for which we were "long overdue" (Schoen 2014). There is clear evidence in the literature that airtight buildings combined with poor ventilation protocols contribute to the spread of airborne diseases such as tuberculosis and SARS (Bhagat et al. 2020), which is now being witnessed with COVID-19. In response to these types of outbreaks, mechanical ventilation strategies, including dilution and exhaust ventilation, ultraviolet germicidal irradiation, and central system filtration were designed to prevent the spread of airborne diseases through HVAC systems in indoor spaces (ASHRAE 2014).

Though the novelty of the disease still limits comprehensive literature about COVID-19 prevention strategies, Abdolmajid Fadaei (2021) conducted a rapid review of the literature that does exist on the topic of ventilation, outdoor air and the transmission of COVID-19 in buildings. Fadaei concluded that ventilation with outdoor air was the most important strategy to mitigate the risk of transmission of the COVID-19 virus, and suggested increasing outdoor air

supply to 100% wherever possible (Fadaei 2021). This strategy is agreed upon by the three most prominent international HVAC-related institutions, ASHRAE (US), REHVA (Europe), and SHASE (Japan). Each of the guidelines issued by these institutions emphasizes the importance of fresh air; however, the specific ventilation rate for eliminating the transmission of airborne particles has not been concretely defined (Guo et al. 2021). Most agencies agree that it is *impossible* to fully eliminate the transmission of the COVID-19 virus indoors, even with strict controls of the HVAC system. Instead, infection risk is minimized through proper measures and ‘bundle control strategies,’ including social distancing and personal hygiene.

4.0 ARGUMENT

Some researchers believe (optimistically) that the COVID-19 pandemic “has laid the groundwork for a more holistic approach towards health in buildings, incorporating both research and practice” (Awada et al. 2022). However, this method would require a transition from the current reliance on *treatment* toward *prevention* practices. By their very nature, infection prevention protocols often conflict with corporate entities who prioritize low organizational overhead costs (Dancer and Dancer 2013). Additionally, there is limited precedent for technological regression in a healthy society because of the close associations between social status and technological development as reviewed earlier, particularly regarding mechanical conditioning and climate control. Data shows that mechanical ventilation and unhealthy indoor environments created by modern building typologies, are putting humans out of sync with the natural microbial rhythms of the planet.

It is important to note that while most studies clearly identify less favorable conditions within sealed, mechanically ventilated spaces, the naturally ventilated areas will still have problems with outdoor pollutants and contaminants, particularly in urban environments, as well as humidity. This complexity calls for a mixed-mode ventilation approach. The authors of this paper do not advocate strictly for either mechanical *or* natural ventilation. Instead, we seek to identify the benefits of fresh, naturally ventilated spaces while learning from the advances of mechanical approaches – both technological and cultural. The two approaches can work in tandem to use less energy while prioritizing human health.

CONCLUSION

The relationship to outdoor air has shifted drastically throughout history. Similarly, the human connection to hygiene has been guided by multiple factors, ranging from scientific reasoning and technological advancements to targeted marketing campaigns and cultural constructs. Because of the close associations between social status and technological development, it is important to pursue a path forward to healthy buildings that embraces both technology and society concurrently.

While engineers and designers seek to make buildings that keep the occupants from getting sick, the authors hope to explore methods for habitation that make occupants *well*. As presented in this paper, there are irreversible impacts of technological anthropocentrism on the planet as well as on the human condition. Identifying the issue of human health in buildings is not just technical, but it is also profoundly social and behavioral. By identifying the root of the issues, we can begin to propose a solution.

REFERENCES

- ASHRAE. 2014. “ASHRAE Position Document on Airborne Infectious Diseases.” Atlanta, GA.
- Awada, Mohamad, Burcin Becerik-Gerber, Simi Hoque, Zheng O’Neill, Giulia Pedrielli, Jin Wen, and Teresa Wu. 2021. “Ten Questions Concerning Occupant Health in Buildings during Normal Operations and Extreme Events Including the COVID-19 Pandemic.” *Building and Environment* 188 (January): 107480. <https://doi.org/10.1016/j.buildenv.2020.107480>.
- Awada, Mohamad, Burcin Becerik-Gerber, Elizabeth White, Simi Hoque, Zheng O’Neill, Giulia Pedrielli, Jin Wen, and Teresa Wu. 2022. “Occupant Health in Buildings: Impact of the COVID-19 Pandemic on the Opinions of Building Professionals and Implications on Research.” *Building and Environment* 207 (January): 108440. <https://doi.org/10.1016/j.buildenv.2021.108440>.
- Bhagat, Rajesh K., M. S. Davies Wykes, Stuart B. Dalziel, and P. F. Linden. 2020. “Effects of Ventilation on the Indoor Spread of COVID-19.” *Journal of Fluid Mechanics* 903 (November). <https://doi.org/10.1017/jfm.2020.720>.
- Blaser, Martin J. 2015. *Missing Microbes: How the Overuse of Antibiotics Is Fueling Our Modern Plagues*. First Picador edition. New York: Picador, 2015. <https://catalog.lib.ncsu.edu/catalog/NCSU3511142>.
- Bodington, George. 1840. *An Essay on the Treatment and Cure of Pulmonary Consumption*. Lomax Successors; Simpkin, Marshall, Hamilton, Kent.
- Brager, Gail S., and Richard J. de Dear. 2008. “Historical and Cultural Influences on Comfort Expectations.” In *Buildings, Culture and Environment: Informing Local and Global Practices*, edited by Raymond J. Cole and Richard Lorch, 177–201. John Wiley & Sons.
- CDC. 2021. “Tuberculosis (TB) - World TB Day - History.” Centers for Disease Control and Prevention. January 28, 2021. <https://www.cdc.gov/tb/worldtbdays/history.htm>.
- Cirstea, Mihai, Nina Radisavljevic, and B. Brett Finlay. 2018. “Good Bug, Bad Bug: Breaking through Microbial Stereotypes.” *Cell Host & Microbe* 23 (1): 10–13. <https://doi.org/10.1016/j.chom.2017.12.008>.

- Crutzen, Paul J. 2002. "Geology of Mankind." *Nature* 415 (6867): 23–23. <https://doi.org/10.1038/415023a>.
- Damsky, Ellen. 2003. "A Way of Life: Saranac Lake and the 'Fresh Air' Cure for Tuberculosis." Ph.D., United States -- New York: State University of New York at Binghamton. <https://www.proquest.com/docview/305238703/abstract/7E0A9CDECAB74D42PQ/1>.
- Dancer, Stephanie J., and Stephanie J. Dancer. 2013. "Infection Control in the Post-Antibiotic Era." *Healthcare Infection* 18 (2): 51–60. <https://doi.org/10.1071/HI12042>.
- Douglas, Professor Mary. 2002. *Purity and Danger: An Analysis of Concepts of Pollution and Taboo*. London: Routledge. <https://doi.org/10.4324/9780203361832>.
- Escombe, A. Roderick, Clarissa C. Oeser, Robert H. Gilman, Marcos Navincopa, Eduardo Ticona, William Pan, Carlos Martínez, et al. 2007. "Natural Ventilation for the Prevention of Airborne Contagion." *PLOS Medicine* 4 (2): e68. <https://doi.org/10.1371/journal.pmed.0040068>.
- Fadaei, Abdolmajid. 2021. "Ventilation Systems and COVID-19 Spread: Evidence from a Systematic Review Study." *European Journal of Sustainable Development Research* 5 (2): em0157. <https://doi.org/10.21601/ejosdr/10845>.
- Graham, Carl Ian. 2016. "High-Performance HVAC." Whole Building Design Guide. 2016. <https://www.wbdg.org/resources/high-performance-hvac>.
- Greenhalgh, I, and A R Butler. 2017. "Sanatoria Revisited: Sunlight and Health." *The Journal of the Royal College of Physicians of Edinburgh* 47 (3): 276–80. <https://doi.org/10.4997/jrcpe.2017.314>.
- Greenhough, Beth, Andrew Dwyer, Richard Grenyer, Timothy Hodgetts, Carmen McLeod, and Jamie Lorimer. 2018. "Unsettling Antibiosis: How Might Interdisciplinary Researchers Generate a Feeling for the Microbiome and to What Effect?" *Palgrave Communications* 4 (1): 1–12. <https://doi.org/10.1057/s41599-018-0196-3>.
- Guo, Mingyue, Peng Xu, Tong Xiao, Ruikai He, Mingkun Dai, and Shelly L. Miller. 2021. "Review and Comparison of HVAC Operation Guidelines in Different Countries during the COVID-19 Pandemic." *Building and Environment* 187 (January): 107368. <https://doi.org/10.1016/j.buildenv.2020.107368>.
- Hisano, Ai. 2017. "Cellophane, the New Visuality, and the Creation of Self-Service Food Retailing." *SSRN Electronic Journal*. <https://doi.org/10.2139/ssrn.2973544>.
- Hobday, Richard A. 2019. "The Open-Air Factor and Infection Control." *Journal of Hospital Infection* 103 (1): e23–24. <https://doi.org/10.1016/j.jhin.2019.04.003>.
- Hobday, Richard A., and John W. Cason. 2009. "The Open-Air Treatment of Pandemic Influenza." *American Journal of Public Health* 99 (S2): S236–42. <https://doi.org/10.2105/AJPH.2008.134627>.
- Holt, Luther Emmett. 1909. *The Care and Feeding of Children*. D. Appleton.
- Joshi, Sumedha M. 2008. "The Sick Building Syndrome." *Indian Journal of Occupational and Environmental Medicine* 12 (2): 61–64. <https://doi.org/10.4103/0019-5278.43262>.
- Karamanou, Marianna, George Panayiotakopoulos, Gregory Tsoucalas, Antonis A Kousoulis, and George Androutsos. 2012. "From Miasmas to Germs: A Historical Approach to Theories of Infectious Disease Transmission," 5.
- Keyser, Hannah. 2015. "A Brief and Bizarre History of the Baby Cage." June 24, 2015. <https://www.mentalfloss.com/article/65496/brief-and-bizarre-history-baby-cage>.
- Kraus, Michal. 2016. "Airtightness as a Key Factor of Sick Building Syndrome (Sbs)." In *International Multidisciplinary Scientific GeoConference : SGEM*, 2:439–45. Sofia, Bulgaria: Surveying Geology & Mining Ecology Management (SGEM). <https://www.proquest.com/docview/2014512056/abstract/66CDBCEAD4714D68PQ/1>.
- Krieger, Nancy. 2011. *Epidemiology and the People's Health: Theory and Context*. Oxford University Press.
- Kushnick, Geoff. 2019. "The Cradle of Humankind: Evolutionary Approaches to Technology and Parenting." SocArXiv. <https://doi.org/10.31235/osf.io/k23md>.
- Logan, Alan C., Susan L. Prescott, and David L. Katz. 2019. "Golden Age of Medicine 2.0: Lifestyle Medicine and Planetary Health Prioritized." *Journal of Lifestyle Medicine* 9 (2): 75–91. <https://doi.org/10.15280/jlm.2019.9.2.75>.
- Martin, Laura J., Rachel I. Adams, Ashley Bateman, Holly M. Bik, John Hawks, Sarah M. Hird, David Hughes, et al. 2015. "Evolution of the Indoor Biome." *Trends in Ecology & Evolution* 30 (4): 223–32. <https://doi.org/10.1016/j.tree.2015.02.001>.
- Mathews, Freya. 2011. "Towards a Deeper Philosophy of Biomimicry." *Organization & Environment* 24 (4): 364–87. <https://doi.org/10.1177/1086026611425689>.
- Milton, Donald K., P. Mark Glencross, and Michael D. Walters. 2000. "Risk of Sick Leave Associated with Outdoor Air Supply Rate, Humidification, and Occupant Complaints: Sick Leave and Building Ventilation." *Indoor Air* 10 (4): 212–21. <https://doi.org/10.1034/j.1600-0668.2000.010004212.x>.
- Moe, Kiel. 2007. "Compelling Yet Unreliable Theories of Sustainability." *Journal of Architectural Education* 60 (4): 24–30. <https://doi.org/10.1111/j.1531-314X.2007.00105.x>.
- . 2010. *Thermally Active Surfaces in Architecture*. Princeton Architectural Press.
- National Center for Biotechnology Information, and U. S. National Library of Medicine. 2009. *The Burden of Health Care-Associated Infection. WHO Guidelines on Hand Hygiene in Health Care: First Global Patient Safety Challenge Clean Care Is Safer Care*. Bethesda, MD: World Health Organization. <https://www.ncbi.nlm.nih.gov/books/NBK144030/>.
- Oldfield, Philip, Dario Trabucco, and Antony Wood. 2009. "Five Energy Generations of Tall Buildings: An Historical Analysis of Energy Consumption in High-Rise Buildings." *The Journal of Architecture* 14 (5): 591–613.

- Read, Emma. 1923. Portable baby cage, issued 1923.
<https://worldwide.espacenet.com/publicationDetails/biblio?FT=D&date=19230313&DB=EPODOC&CC=US&NR=1448235A>.
- Rios, José Luiz de Magalhães, José Laerte Boechat, Adriana Gioda, Celeste Yara dos Santos, Francisco Radler de Aquino Neto, and José Roberto Lapa e Silva. 2009. "Symptoms Prevalence among Office Workers of a Sealed versus a Non-Sealed Building: Associations to Indoor Air Quality." *Environment International* 35 (8): 1136–41.
<https://doi.org/10.1016/j.envint.2009.07.005>.
- Schoen, Lawrence J. 2014. "What ASHRAE Says About Infectious Disease." *ASHRAE Journal*, November, 3.
- Tomes, Nancy. 1998. "The Gospel of Germs: Men, Women, and the Microbe in American Life." Cambridge, Mass: Harvard University Press.
- United Nations Environment Programme. 2020. "2020 Global Status Report for Buildings and Construction: Towards a Zero-Emissions, Efficient and Resilient Buildings and Construction Sector."
- US EPA, ORD. 2017. "Indoor Air Quality." Reports and Assessments. US EPA. November 2, 2017.
<https://www.epa.gov/report-environment/indoor-air-quality>.
- World Health Organization. 2020. "The Top 10 Causes of Death." In . <https://www.who.int/news-room/fact-sheets/detail/the-top-10-causes-of-death>.

Built Environment and Walking Behavior: A Systematic Review on Campus Walkability Assessments

Gisou Salkhi Khasraghi¹

¹Texas Tech University, Lubbock, TX

ABSTRACT: According to Healthy Campus 2020, only 48.7% of college students meet federal guidelines for weekly aerobic activity (Healthy Campus Baseline Report, 2015b). General inactivity among staff and students has also been shown to increase health issues such as obesity and diabetes. While there are a variety of health initiatives that could help address these issues, walkability has consistently proven to play a crucial role in promoting healthy activities on college campuses. However, there is not a standardized campus walkability index available to urban planners and policymakers that maps the impacts of built environments on the walking behaviors of those who utilize these spaces. It is critical to consider walkability-supportive environments in campus planning and design. Unique aspects of campus environments that are correlated to walking should also be examined by those responsible for the design and maintenance of campus environments. The purpose of this study is to provide a systematic, narrative review of campus environmental factors in relation to walking behaviors and preferences of campus users. This study also argues that a campus walkability index would be invaluable to the planning and execution of campus designs and provide a metric for evaluating the current walkability of existing environments. This review will include studies between 2011 and 2020 that focus specifically on walkability, physical activity, and measured built environment indicators on walking behavior on college campuses. First, the concept of walkability in educational settings and the importance of campus walkability as a health-promoting transportation choice are discussed. Next, built environment attributes that support walking behaviors are presented and the measuring methods for campus walkability are outlined. Finally, an integrated campus walkability index is proposed that addresses the infrastructure, safety, accessibility to facilities, proximity, aesthetic, lighting, and shading.

KEYWORDS: Walkability, built environment, physical activity, Campus walkability Index, healthy campus, walking behaviors.

INTRODUCTION

Studies have shown that increasingly large numbers of college students are at risk of becoming obese, an issue that is exacerbated by inactivity and a sedentary lifestyle. According to Healthy Campus 2020, only 48.7% of college students meet federal guidelines for weekly aerobic activity. In fact, several studies suggest that almost half of all college students in the United States do not get enough fitness or physical activity in general (King et al., 2020). While there are a variety of factors that contribute to this issue, one area of interest that has recently emerged is research focused on the overall walkability of college campuses and how this walkability influences physical activity in college students. Walkability is a measure of whether the built environment of a neighborhood encourages people to walk. Walking is extremely beneficial to one's physical and mental wellness. Furthermore, a walkable city encourages the balanced growth of urban areas and public services, as well as better living conditions and environment satisfaction. Different disciplines, such as urban and transport planning, leisure and health studies, have contributed to a better theoretical understanding of the associations between the built environment and health (Sallis 2009).

Within the limited number of research papers published on walkability on college campuses, there are a diverse number of methodologies used to evaluate walkability and no uniform language for discussing the results. Moreover, campus walkability were evaluated at different scales. Therefore, this paper aims to unify the language used and catalogue the different methodologies and various scale of measurement through a systematic review of the current literature devoted to walkability on college campuses. This systematic review started with detailed methodology including study selection criteria, search strategy, data extraction and preparation, and study quality assessment. Then, it followed by results, which is divided into selected studies characteristics, measures of campus walkability, and analyzed campus built environment units. Finally, the discussion section summarizes the review's findings, while the conclusion section discusses the implications for future research.

1.0 METHODOLOGY

A systematic review was conducted in order to unify campus walkability component terminology and evaluation methods, as well as evaluate the pros and cons of each method.

1.1 Study Selection criteria

The review includes studies that met all of the following criteria: (a) study subjects: college students; (b) research findings: healthy behaviors, physical activity, environmental factors related to walkability; (c) article types: peer-reviewed original research articles; (d) publishing date: from 2011 to December 2021 (e) language: articles written in the English language

1.2. Search strategy

Within the electronic databases, including PubMed, Web of Science, and Scopus, a key words search was applied that scanned article titles and abstracts for the following three phrases: 1) campus walkability 2) built environment, and 3) students physical activity. The full text of potentially relevant publications was retrieved and evaluated. Specifically, the titles and abstracts of the articles identified through the keyword search were screened against the study selection criteria. Test searches were carried out to determine the sensitivity and specificity of the search words, and changes were made as needed.

1.3. Data extraction and preparation

Author names, year of publication, country, sample size, analysed unit, data source, measures of walkability, and key findings were all collected using a standardized data extraction form each selected study.

1.4. Study selection

The flowchart of the study selection procedure is shown in Figure 1. Through the keyword search, we found a total of 431 articles. Three hundred eighty-seven items were eliminated after the title and abstract screening. After reviewing the entire texts of the remaining 44 papers against the study selection criteria, 33 articles were eliminated. This review covered the remaining 8 studies that looked at the campus walkability and built environment component related to campus walkability.

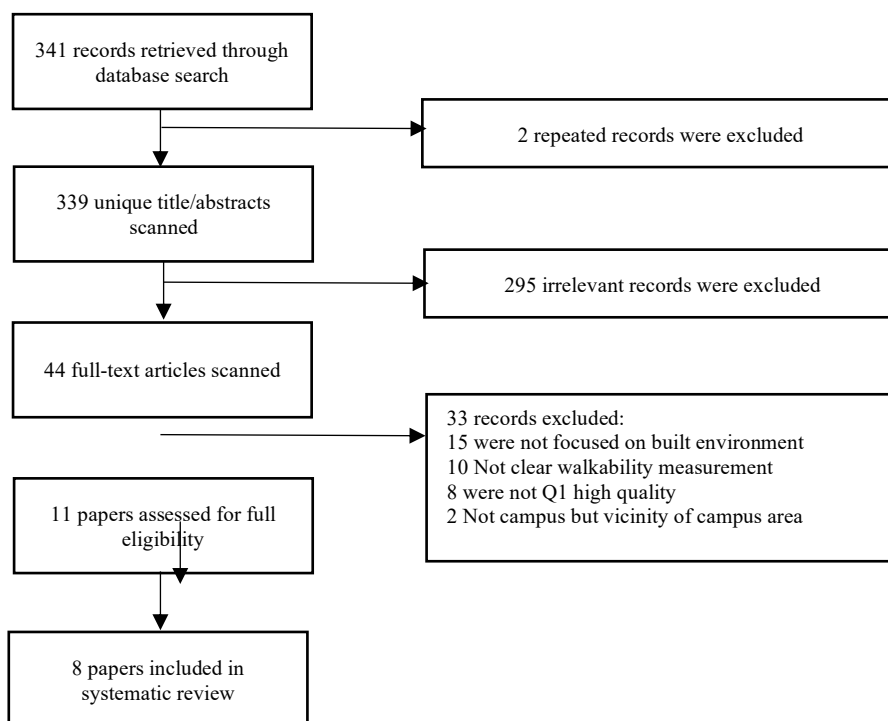

Figure 1: Systematic review flowchart

2.0 RESULTS

2.1. Selected Studies characteristics

Table 1 lists the key characteristics of the studies that were included. The cross-sectional examinations accounted for the majority of the studies (n = 5), followed by longitudinal studies (n = 2). The articles in this review came from a total of five different countries, including the United States (n=5), China (n = 2), South Korea, Malaysia, and Pakistan (all n = 1). The majority of investigations were focused on students, and two studies involved staff and faculty.

Table 1. Characteristic of the studies included in the systematic review

Author, year of publication	Study Location	Study Design	Campus walkability Analyzed Unit	Environmental/Physical Factor/Component	Sample SIZE/Human	Measuring Tool	Key Finding
Lee et al.,(2020)	South Korea	cross sectional	Routes	safety, quality, distance, and experience	127 student	Questionnaire, environmental audit	The safety and quality of routes were more essential to "smartphone walkers," while the shortest distance and a pleasurable walking experience were major variables in route selection for walkers without phones.
Horacek et al.,(2018)	United States	Cross-sectional.	Path segments	Safety, Quality, and comfort	1384 student	The Cognitive Behavioral Physical Activity Questionnaire audit for environmental	College students' walking behavior and BMI were linked to the ease of walking and biking on campus. The findings suggest that policy and structural supports for walkable/bikeable areas should be prioritized to augment and enhance treatments that encourage individual behavior change for PA and weight management.
Ramakreshnan et al.(2020)	Malaysia	Cross-sectional	Layout	street connectivity and accessibility traffic safety pedestrian infrastructure experience land use campus neighbourhood	504 student, staff staying in campus	online survey using a structured questionnaire	The data revealed that the majority of participants considered street connectivity and accessibility as the principal factor impacting campus walkability, which improves network connections and better distributes traffic flows.
Zhang et al. (2020)	China	cross sectional	Layout Street network	weight of 13 facilities curve of time-decay	36,000 faculty, student, staff 5	61 questionnaire and field interviews questionnaire demographic variables, such as age, gender, major, grade, and apartment addresses of students	The results suggest that the multi-center layout of the old campus has a high level of walkability, whereas the concentrated structure of the new campus has a lower level of walkability. Furthermore, the diverse arrangement of facilities surrounding the historic campus encourages people to walk to nearby locations.

Kinget et al. (2020)	United States	cross sectional	Route	Infrastructure safety aesthetics sidewalks continuity motor vehicle potential risk time allotted at intersections for pedestrians to cross shading/lighting along campus walking routes trash along sidewalks	83 student	Environmental scan Audits Paper surveys	This research discovered that campus members' perceptions of walkability are similar to those observed in the campus environment, and that components of both may influence physical activity levels among university students, faculty, and staff.
Memon et al. (2020)	Pakistan	NA	Route	Sidewalk width, Sidewalk Maintenance, Streetscape, Shading Devices	384 respondent	detailed survey, questionnaire, personnel observation(Audit), Traffic and Pedestrian Count Survey	According to the results of the Average Index Analysis, the most important environmental elements are: Shade, Garbage cans/Recycling, Personal safety (fence between roads and footpaths), as well as the remaining parts
Sun et al.(2014)	China	longitudinal	Layout	land use, pedestrian network connectivity,	198 student	intersect analysis through ArcGIS self-report of walking time Walking diary and end times of the trip, the walking route, the social environment and the objective of the trip (the activity at the destination).	Results showed that Walking behaviors, such as lengths walked, proportion of trips walked (vs motorized trips), and altitude ranges traveled, were all affected by changes to the physical environment on a university campus in Hong Kong.
Sisson et al.(2008)	United States	cross sectional	Path Segment	annual average daily traffic, posted speed limit, number of through lanes, presence of sidewalks (eg, both sides continuous, 1 side partial), sidewalk material (eg, concrete, asphalt), sidewalk surface condition, sidewalk width, buffer width (area between the street and sidewalk), curb ramps, adequate lighting, isolated problem spots	20 students	ArcGIS 9.0,Walking Suitability Assessment survey each student's drawn map	The findings imply that the built environment has a direct influence on physical activity related to transportation. There was a substantial disparities between campuses in terms of daily physical activity (when students are on campus), as measured by pedometers, accelerometers, and weekday campus distance walked.

2.2. Measures of Campus walkability

The measures of campus walkability and built-environment-related factors and main findings in the selected studies were summarized (Table 2). Walkability was measured by using different geographical units such as routes ($n = 3$), path segment ($n=2$), street network, or layout ($n=3$). The focus of this study is the environmental factors' evaluation method and data source. All but one of the studies measured walkability with either a structured assessment survey (questionnaire), an environmental audit, or both. Ramakreshnan et al., 2020; Zhang et al., 2020; and Sisson et al., 2008 each conducted a structured assessment survey. Horacek et al., 2018 utilized an environmental audit, and Lee et al., 2020; Kinget et al., 2020; and Memon et al., 2020 each used a combination of the two. Sun et al. 2014 relied on the ArcGIS tool to collect and analyze environmental data, and Zhang et al., 2020 incorporated ArcGIS into its measurements alongside the assessment survey and environmental audit.

Despite these similarities, each of these studies used different surveys focused on specific environmental attributes along with questions regarding demographics and race, behavioral information, or gender.

Each of the six articles that employed a structured assessment survey, either solely or in conjunction with an audit, evaluated a variety of different factors depending on their focus. The article by Lee et al. (2020) focused student perception and evaluation of campus route qualities by evaluating four different attributes of the physical built environment: nighttime safety, quality, distance, experience. Ramakreshnan et al. (2020) used an online structured questionnaire (survey) consisting of two sections: participants' motivation for walking within the campus and the six main environmental factors of the campus (see Table 1). Zhang et al. (2020) used a survey to determine how often students used different public service facilities, including canteens, libraries, gyms, and retail stores, as well as their preference for one facility over another when multiple options of the same type were available. King et al.'s (2020) survey consisted of walkability indicators, such as sidewalk/path continuity, the time it took to cross in intersections, shading and lighting, and barriers or trash on the sidewalks. Memon et al. (2020) also examined walkability indicators, though they differed from those used by King et al. These indicators included sidewalk width, sidewalk maintenance, streetscape, and shading devices.

There were also minor differences among the environmental audits in the four articles that included them. Both Horacek et al. (2018) and King et al. (2020) used the Center for Disease Control (CDC) and Prevention's Healthier Worksite Initiative Walkability Audit for built environment measurement. However, King et al., (2020) also combined CDC Healthier Worksite Initiative Walkability Audit with Delaware Institute's Healthy Communities. Horacek et al. (2018) used the Center for Disease Control and Prevention's Healthier Worksite Initiative Walkability Audit looked at 44 path segments per university campus. This audit included 12-item for measuring campus characteristic such as nighttime safety features, quality and comfort. These factors had a specific weight score based on importance. For example, safety with weight score. Lee et al. (2020) used audit for direct observation to understand how people use space and their choice of walking route and the relationship between their route selection and route condition. King et al. (2020) applied environmental scan audit to evaluate route to identify problematic areas and state of existing routes. This audit tool consisted of two walkability assessment tool CDC's Healthier Worksite Initiative Walkability Audit Tool and Delaware Institute's Healthy Communities. Audit tool contained 24 questions evaluating various walkability characteristics.

Out of 8 studies, two studies coupled their measurement method with sketch map to understand participants' perception of walking experience. Lee et al. (2020) included sketch map of participants walking route to find the route they selected and their spatial memory of that built environment features. Sisson et al. (2008) used participants' drawn map of daily walking route to retrace their trip using ArcGIS measuring tool.

Table 2. Built environments geographic units for campus walkability measurement and pros and cons of method.

Built environment Geographic Unit	Measured Environmental Factors/attributes	Measuring Tool or Data Source	Pros of scale and method	Cons
Layout and street network	A. facility weights Cure of time-decay block length intersection density	Questionnaire field interviews GIS network-analysis	Measuring walkability not only through GIS but also through questionnaire	Some subjective criteria of the walking experience, such as a sensation of comfort and safety, are not adequately reflected by the differences between subjective cognition and objective judgment.
	B. proximity of land use street connectivity and accessibility pedestrian infrastructure walking experience traffic safety campus neighborhood	Online Questionnaire	Suggested comprehensive in detail environmental factors associated to walkability in campus neighborhood	limits of an online sample technique, in which the questionnaire link could only be accessed by people who had internet connection. Exclude any objective measurement of campus walkability such as indexes or walking audits
	C. land use, pedestrian network connectivity,	ArcGIS Self-report of walking time, distance, routes, destination activity	Few longitudinal studies of changes in walking behavior integrate before-and-after survey data with quantitative changes in the built environment.	This study did not include a control group. The validity of the walking journal was not established.

Path Segment		Walkability Audit	Valid and reliable surveys, an objective audit of the walkability environment are all used.	It is self-report of physical activity not based on tools like accelerometer-measured physical activity data
	Safety, quality, comfort.			
	Annual average daily traffic, posted speed limit, number of through lanes, presence of sidewalks (eg, both sides continuous, 1 side partial), sidewalk material (eg, concrete, asphalt), sidewalk surface condition, sidewalk width, buffer width (area between the street and sidewalk), curb ramps, adequate lighting, and isolated problem spots	ArcGIS Questionnaire/survey Sketch map	Detail attributes of path segments like materials, surface condition curb ramps are also considered. Considered students daily walking through students sketch map for their daily trajectories.	This method only relies on students self-perception not objectively measuring of environmental characteristics.
Route				
	A. safety quality distance experience	ArcGIS data Questionnaire Sketch map Audit	Mix method of observation(audit), sketch map and survey can help to evaluate user perception of path and sketch map help to examine spatial memory of students about the walking path	Sketch map is not always reliable since some students are not good at drawing and their perception might be effected by their ability of sketch
	Sidewalk width, Sidewalk Maintenance, Streetscape, Shading Devices	Questionnaire, Audit	This study include both researcher audit of traffic and student questionnaire on environmental indicators for campus walkability	This study didn't include important walkability elements such as safety. There is no reasoning chain for environmental attributes selection
	C. Infrastructure safety aesthetics sidewalks continuity motor vehicle potential risk time allotted at intersections for pedestrians to cross shading/lighting along campus walking routes trash along sidewalks	Audit Questionnaire	This study include both subjective and objective data such as participant questionnaires on campus walkability and observational audits of the campus environment.	Environmental scans did not capture all key walkability parameters, such as pathway surface type or inclination of walking paths. There were no precise scores created for each route.

2.3. Analysed campus built environment Units

Each of the articles included in this review were then classified using three broad categories: route, path segment, layout and street network (see table 2). The scale for measuring campus walkability were sorted out in four geographical categories (layout and street network, path segment, route). Out of 8 studies, three studies were used routes, two studies used path segments, three studies was applied layout or/and street network and whole environmental factors for calculating the walkability of campus. The following sections are about different units of walkability with related built-environment indicators and tools for calculation and pros and cons about each method/measuring tool.

2.3.1. Path segment

Two studies were assessed campus walkability in micro scale called path segment. It is a section of a route. Two studies were used segment of path to measure campus walkability (Sisson et al., 2008, Horacek et al.2018). Horacek et al.2018 examined safety, quality and comfort of path segment, the other study, Sisson et al. (2008), calculated walkability of each path segment and associated sidewalk through environmental characteristics included average daily traffic, speed limit, existence of sidewalk, sidewalk material, sidewalk surface condition, curb ramps, lighting condition all these assessment indicators were scored between very good to poor /no sidewalk through audit tool. To sum up, sidewalk quality (material, surface condition, curb ramps), safety, lighting were extracted from two studies environmental characteristics.

2.3.2. Route

The Mezzo scale of built environment unit is route. Three studies investigated campus walkability in the route scale (Kinget et al., 2020, Memon et al., 2020, Lee et al.2020). Lee et al.(2020) examined following indicator's associated to routes: safety, quality, distance between origin and destination, experience. Kinget et al., 2020 assessed walkability through environmental indicators of routes listed as: infrastructure (existence of sidewalk and its condition, crosswalk appearance and amenities at intersections, continuity of sidewalks /paths continuous, and barrier or trash in sidewalk), safety, aesthetics, and, time for crossing in intersection, shading, lighting, vehicle risk, and evaluators' walking experience. Another study by Memon et al. (2020) used indicators comprised sidewalk width, sidewalk maintenance, streetscape, and shading devices for route assessment. Measuring methods included detailed survey, questionnaire, personnel observation, Environmental scan Audits. All environmental indicators of three studies were extracted and categorized in to: safety, route infrastructure (width, continuity, cleanness/barrier, shading/lighting), walking experience (distance, aesthetics, streetscape).

2.3.3. Layout and Street Network

Three studies out of eight studies were evaluated campus layout for calculating macro level campus walkability. In a study, Ramakreshnan et al.(2020), defined indicators as following: land use(Facilities, services and public amenities, parks relational area, building proximity), campus neighborhood(fenced and guarded, lesser parking lots), pedestrian infrastructure, experience (aesthetics, cleanliness and maintenance, thermal comfort, topographic attributes, nuisance from animals, street trees and ornament plants, landmarks, wall paintings), traffic safety (Traffic lights, crosswalks, traffic police, speed limit, speed bumps, grass or dirt), street connectivity and accessibility (multiple routes and shortcuts). All these environmental indicators will be scored based on sample respondent. Sun et al. (2014) evaluated land-use, pedestrian network connectivity of built environment. Another study, Zhang et al. (2020) examined facilities' use frequency, cure of time-decay block length, and intersection density. The main indicators of three studies which focused on Marco scale (layout) of campus walkability were listed as follow: land use (block length, facilities diversity), campus neighborhood, pedestrian infrastructure, experience, traffic safety, pedestrian network connectivity and accessibility, and intersection density.

3.0 DISCUSSION

The goal of this study was to describe and classify campus walkability studies according to geographic units of analysis and diverse measuring tools and methods. In all of the studies, data was collected based on participants' assessments of environmental features. As a result, survey is one of the most extensively used methods for determining walkability on campus. Six of the eight studies assessed the campus-built environment using a questionnaire or survey. Safety, infrastructure, experience, street connectivity, intersection density, and land-use diversity are the major indicators used to measure campus walkability in all units. Few studies have used participants' sketch maps to better understand their spatial memory and cognition of the built environment. The majority of campus walkability research were conducted to determine if there was a link between walkability and other parameters such as BMI, smartphone user perception, student motivation, and physical activity level.

The impact of the built environment on walkability is broadly supported by all studies(See table1). For example, Lee et al.(2020) discovered that route quality affects both smartphone and non-smartphone users. Furthermore, Ramakreshnan et al.(2020) found that improving street connection and accessibility had a significant impact on reducing traffic congestion and enhancing walkability. Zhang et al. (2020) evaluated the old and new campus layouts and concluded that a more diverse distribution of facilities increases overall campus walkability. According to Sisson et al. (2008), the campus built environment has an impact on student daily walks and overall physical activity, and there are differences in how campuses support and encourage walking. Users' perceptions of campus walkability, including students, employees, and faculties, are strikingly similar to actual observations of built environment elements, according to Kinget et al. (2020). Walking behavior and length of walk are altered by changes in the built environment, according to Sun et al. (2014).

Horacek et al. (2018) discovered that the built environment influences people's motivation to be physically active, particularly to walk more and maintain a healthy weight and BMI. For all scales of measurement, the major environmental factors that were often used in this research are safety, infrastructure, and user experience. When the campus environment was studied at the micro scale, additional detailed elements of the environment were incorporated, such as sidewalk material, curb ramps, and sidewalk surface. The walkability of the entire campus plan was assessed on a macro scale. Aside from single-route characteristics, this scale covered all street connectivity, land-use/facilities distribution/diversity, and facility accessibility for measuring campus walkability. Although there have been research on campus walkability and related physical environment features, none have looked at how to evaluate it. This study looked at eight studies that looked at walkability on university or college campuses. Table 1 summarized the outcomes of each study in this review. A small number of studies have been conducted on college students' physical activity, specifically walking on campus. Furthermore, longitudinal studies to evaluate the built environment on campus before and after changes in built environment features are being conducted.

CONCLUSION

The majority of research have used subjective criteria to assess campus walkability. The perception of the walking environment by users (mostly students, staff, and teachers) is crucial. There is no single comprehensive index for measuring campus walkability, according to all studies on campus walkability and student physical activity. The following suggestions can be made based on the findings: 1) More research on the campus walkability measurement tool is needed. 2) Research should be focused on developing a unique index for the campus, similar to how local walkability indexes are calculated. 3) More cohort longitudinal studies that look at campus walkability over time or comparative studies of the current environment vs. the modified environment are needed, as well as 4) additional variables including weather influence, crime, and a sense of place. Based on cross-sectional studies, potential implications for policymaking and urban planning can be reported, urban designers and urban planners should aim to improve infrastructure and create a pleasant and supportive campus environment to encourage more physical activity and prevent non-chronic disease. Identifying environmental features can assist city planners, designers, and healthcare practitioners in making decisions for walkable environments that provide more opportunities for college students, staff, and faculty to be more physically active and choose walking as a means of staying healthy while pursuing their academic goals.

REFERENCES

- Sisson, McClain, J. J., & Tudor-Locke, C. (2008). Campus Walkability, Pedometer-Determined Steps, and Moderate-to-Vigorous Physical Activity: A Comparison of 2 University Campuses. *Journal of American College Health, 56*(5), 585–592. <https://doi.org/10.3200/JACH.56.5.585-592>
- Sun, Oreskovic, N. M., & Lin, H. (2014). How do changes to the built environment influence walking behaviors? A longitudinal study within a university campus in Hong Kong. *International Journal of Health Geographics, 13*(1), 28–28. <https://doi.org/10.1186/1476-072X-13-28>
- Ramakreshnan, Fong, C. S., Sulaiman, N. M., & Aghamohammadi, N. (2020). Motivations and built environment factors associated with campus walkability in the tropical settings. *The Science of the Total Environment, 749*, 141457. <https://doi.org/10.1016/j.scitotenv.2020.141457>
- Horacek, Dede Yildirim, E., Kattelmann, K., Brown, O., Byrd-Bredbenner, C., Colby, S., Greene, G., Hoerr, S., Kidd, T., Koenings, M. M., Morrell, J., Olfert, M. D., Phillips, B., Shelnut, K., & White, A. (2018). Path Analysis of Campus Walkability/Bikeability and College Students' Physical Activity Attitudes, Behaviors, and Body Mass Index. *American Journal of Health Promotion, 32*(3), 578–586. <https://doi.org/10.1177/0890117116666357>
- King, Kaczynski, A. T., Knight Wilt, J., & Stowe, E. W. (2020). Walkability 101: A Multi-Method Assessment of the Walkability at a University Campus. *SAGE Open, 10*(2), 215824402091795. <https://doi.org/10.1177/2158244020917954>
- Zhehao Zhang, Thomas Fisher, & Gang Feng. (2020). Assessing the Rationality and Walkability of Campus Layouts. *Sustainability (Basel, Switzerland), 12*(10116), 10116. <https://doi.org/10.3390/su122310116>
- Irfan Ahmed Memon, Saima Kalwar, Noman Sahito, Sabeen Qureshi, & Noman Memon. (2020). Average Index Modelling of Campus Safety and Walkability: The Case Study of University of Sindh. *Sukkur IBA Journal of Computing and Mathematical Sciences, 4*(1). <https://doi.org/10.30537/sicms.v4i1.582>

Walking as Engagement

Sarah Gamble¹

¹University of Florida, Gainesville, FL

ABSTRACT: Community engagement is essential to the design of equitable, inclusive, and resilient urban communities. As part of professional practice for designers and architects, the ability to select and implement the most appropriate engagement methods and customize them to local conditions, cultures, history, stakeholders, etc. is an important skill. In this paper, the use of walking is explored as a tool for community engagement through the review of three case studies: *Shifting Impressions*, New York City, New York, USA; *Drawing in Transit*, Calgary, Alberta, Canada; and *Found Object Walk*, Austin, Texas, USA. Set within urban landscapes in Northern America, each case study draws on the power of walking, in combination with a second creative medium (ceramics, sketching, collage), to actively engage participants within the public realm and highlight opportunities to implement walking as part of design and development processes. Working to overcome barriers to engagement, such as language and education level, their creators each shape an active experience, which diversifies the ways participants share and communicate. The selected case studies are presented to foster new ideas and innovative methods to engage communities in the shaping of equitable and inclusive urban landscapes.

KEYWORDS: walk, community engagement, urban landscape, inclusion

INTRODUCTION

Cities have the capability of providing something for everybody, only because, and only when, they are created by everybody.” — Jane Jacobs, [The Death and Life of Great American Cities](#)

Community engagement is essential to the design of equitable, inclusive, and resilient urban communities. As Jacobs explains, these goals can only be achieved when stakeholders are central to design and development processes, therefore making community engagement an important facet of professional practice for designers and architects. The ability to select and implement the most appropriate engagement methods and customize them to local conditions, cultures, history, clients, etc is an important skill. In this paper, the use of walking is explored as a tool for community engagement. Set within urban landscapes in Northern America, the paper investigates three case studies: *Shifting Impressions*, New York City, New York, USA; *Drawing in Transit*, Calgary, Alberta, Canada; and *Found Object Walk*, Austin, Texas, USA. Each case study draws on the power of walking, in combination with a second creative medium (ceramics, sketching, collage), to actively engage participants and highlight opportunities to implement walking within professional and academic design practice.

With a focus on active and creative engagement, the case studies are drawn from a multi-year, interdisciplinary research project exploring how designers and other creatives harness the power of walking to gather information, analyze conditions, build relationships, and inspire creative processes. The research looks for examples from architecture, planning, and other creative fields that draw designers and the community together to share knowledge, look at spaces and conditions, and build a shared understanding of the physical, social, and cultural environment. Highlighted within the selected case studies, the pairing of walking and creative-making diversifies the ways participants share and communicate, and helps to overcome barriers to engagement, such as language and education level. Participant feedback can take place in visual formats, such as the subject of a sketch or choice of collage materials, and verbally, such as sharing a personal story or asking a question.

1.0 BACKGROUND

1.1 The Movement of the Body

Part of our everyday lives and incredibly human, walking is a simple and accessible method for engagement with our surroundings and others that provides on-the-ground, real time experiences. Walking as a research and teaching tool has a long history within built environment fields, ranging from Aristotle’s Peripatetic School set within highly measured Greek colonnadesⁱ to the Situationists’ derive for the contemporary cityⁱⁱ. While the field of architecture has more recently focused on the connection between the hand and the eye, the entirety of the body holds great potential. For

example, Architectural Educator Ben Jacks of Miami University explores walking as an analytical tool: “Only by walking the land, fully engaged and immersed as we read carefully and deeply, can we truly know a place. Thought of this way, the walking practice of reading involves data collection and assembly, interpretation and representation, and imaginal fictions.”ⁱⁱⁱ

Developing psychology research reinforces many creatives’ intuitive understanding about the connection between the mind and body. In her 2019 book, *Mind in Motion: How Action Shapes Thought*, Cognitive Psychologist Barbara Tversky explores the connections between spatial thought and the movement of the body. With applications in architecture, planning, and other built environment fields, she discusses our physical understanding of spaces and the value of toggling between allocentric and egocentric perspectives. “Making sense of mixed perspectives might be difficult but ultimately has benefits: it makes our own thinking more flexible.”^{iv} By understanding our own physical capabilities and a range of perspectives, we can better understand the bodies and experiences of the future users of architectural and urban spaces.

1.2. Defining Walking and Community Engagement

The term *walking* is intended as an inclusive term encompassing a range of active modes for moving the human body. For example, pushing a stroller and rolling a manual or electric wheelchair would be included, therefore capturing the denotative action and the connotative approach to moving our bodies in relationship to space and/or place at slow speeds. While often grouped with biking in the category of ‘active transportation’^v, walking, in this context, excludes the use of scooters, bicycles, skateboards, and other vehicles that allow for increased speeds of travel.

Community engagement is broadly defined as “...the process of working collaboratively with and through groups of people affiliated by geographic proximity, special interest, or similar situations to address issues affecting the wellbeing of those people.”^{vi} While governmental processes require it, community engagement is a typical component of design and development projects that impact the public, including affordable housing, educational centers, neighborhood planning, and transportation facilities. As outlined by the International Association of Public Participation, community engagement processes are designed to “inform, consult, involve, collaborate, and/or empower” participants aligned with public participation goals and “promise(s) to the public”.^{vii} Designers of engagement processes include architectural and planning professionals and/or communication and engagement professionals, dependent on project scale, budget, and the imperative of the client.

2.0 CASE STUDIES

2.1. Overview

Three case studies presented here have been selected for their use of walking, in combination with a second creative medium, and their potential to foster innovation in community engagement for design and development processes. This intersection of walking and creative-making shapes an active experience for the participant that prioritizes observation, rather than developing arts skills. The events are intentionally active to engage participants and foster dialogue about the built environment, a primary goal for architects and designers as they shape inclusive urban landscapes.

2.2. *Shifting Impressions, New York, New York, USA*

A collaborative project of Artist / Urban Designer Liene Bosque and Ceramist Nicole Siesler, *City Souvenirs* is a series of 15 urban walks in New York and Chicago neighborhoods described by the artists as “a site-responsive project that uses walking, clay, and public participation to create tangible connections between people and place.”^{viii} Taking shape as public art commissions and/or public programming, Bosque and Siesler invited participants on collective walks to engage the built environment with help from malleable clay and storytelling.^{ix}

Part of the larger series, *Shifting Impressions* was a group of three walks commissioned by the non-profit Artists Alliance Inc to explore New York City’s Lower East Side. With a theme or focus in mind, the artists designed each walk with predetermined stops to share local history, often leading participants to share personal stories. Participants were then invited to make impressions of architectural and material details around them, which they felt captured the place, their personal memory, etc. The artists wore coverall uniforms and pushed a handmade, steel cart with plastic bins to hold the needed supplies.^x Capturing the individual through the force and shape of the hand, the pressed clay pieces were stamped with a day and time, and then collected to become part of the larger project. Following the walks, the clay pieces were fired to become a tangible outcome of the programming, described by the artists as a collective ‘map’ of the experiences.^{xi}

Each walk was designed to engage a unique topic that spoke to the “heterogeneity” of the community and built environment.^{xii} Led by Bosque in April 2015, one walk focused on the immigrant history and cultural heritage, including visits to the Eldridge Street Synagogue, Essex Park, and Tenement Housing. At each stop, Bosque explained the location and brief history, fostering thoughts and responses from the group. A video documenting the event highlighted

spontaneous stories shared by the participants. “Even though I’m not from New York . . . and other people aren’t from here, at some point someone in our families came through this entry point . . .” shared one woman whose grandfather had immigrated to NYC’s Chinatown in the 1950’s.^{xiii} Before capturing an architectural detail from the façade of a former newspaper’s office, one participant shared childhood memories of buying the local Yiddish newspaper for his grandmother.^{xiv} Another resident exiting her apartment building, a tenement structure, came upon the group in route and shared information about the building owner. In response to their invitation, she then took the impression of decorative hexagon tiles inlaid at the entry door.^{xv}

This cultural heritage walk was designed to be both educational and creative. As Brazilian-born Bosque shared local history, participants felt comfortable to share personal, and at a times, private information about themselves and their families in connection with the physical location. These interactions deepened the collective knowledge of the place. The clay impressions became a physical manifestation and opportunity for participants to record and contribute to a collective physical outcome. The clay also gave them something physical to do, going beyond the verbal and visual. The activity was tangible and transformed the walk into a multi-dimensional experience that fostered intentional awareness of the surrounding environment. As Bosque explained, “The action of walking, as an art-making tool, encourages the audience to slow down and notice the small details that amount to our daily urban experience.”^{xvi}

2.3. Drawing in Transit, Calgary, Alberta, Canada

In 2015, the artist team of GO collaborative, a design and planning firm focused on creative placemaking, community engagement, public art, and cultural planning, and Legge Lewis Legge, an interdisciplinary art and architecture studio, were commissioned by the City of Calgary Public Art Program and Calgary Transit to create a Community Cultural Development (CCD) Public Art Project tied to the completion of the Tuscany LRT Station. The CCD project was the largest public art commission of its kind in Canada up to this point, defined by the City of Calgary as: “the use of collaborative, creative and innovative problem-solving approaches and tools to leverage cultural resources in resolving planning issues and concerns of the community. The process provides the opportunity to enhance the quality of life and unique sense of place among residents.”^{xvii}

Focused on the Tuscany, Rocky Ridge, and Royal Oak neighborhoods that surround the Station, the artist team invited transit riders and residents to explore and create within their community through a series of creative excursions. Originating at the Tuscany Station, participants were led by the artist team and collaborating local artists into the landscape on foot, drawing them outside of their typical patterns of travel and daily life. Both educational and artistic, the activities, led by GO collaborative’s Sarah Gamble and Lynn Osgood in collaboration with Calgary artists and resource persons, created individual and collective opportunities to celebrate the local community. Incorporating drawing, collage, printmaking, and sculpture, the activities became a vehicle to engage, understand, and actively imagine into the area and build upon the participants’ connection to place. Documentation of the experiences and the art created by participants contributed to a collective piece capturing the community process.^{xviii}



Figure 1 (left): Riding on the LRT Red Line, participants did 60 to 90 second sketches of their environment. Credit: Design Cause.



Figure 2 (right): One participant presses her transparency against the window to compose a sketch of the LRT infrastructure. Credit: Design Cause.

One of four excursions each offered twice, *Drawing in Transit* was a transportation-focused event exploring Calgary's history and development along the LRT Red Line. To start, Artist Isabel Porto shared examples of her public art work, which engage the public by drawing in unexpected places. Aligned with Porto's approach, each participant was provided a transparent clipboard, 10 clear transparency sheets, and a black marker. Embarking from the Station, the group began a series of 60 to 90 second sketches between Tuscany and the 8th Street Station, producing one sketch at each stop (Figures 1 and 2). Arriving downtown, the artists led participants on foot in the downtown area, culminating at another LRT station for their return trip. Throughout, Calgary Historian Harry Sanders shared development history and what was happening in the city at the time (Figure 3). Following the excursions, Porto brought together sketches from participants to create a series of collages capturing the collective experience (Figure 4).^{xix}



Figure 3: Participants pause to hear Historian Harry Sanders speak about the development of downtown Calgary. Credit: Design Cause.

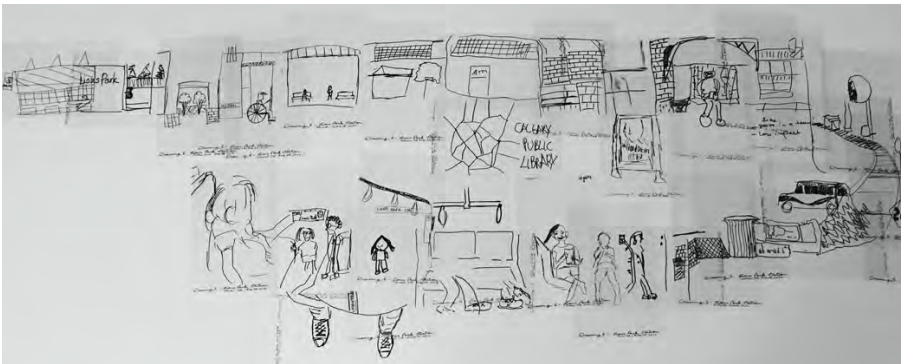

Figure 4: Artist Isabel Porto composed a collective collage of the participant sketches drawn at the Lions Park Station. Credit: Isabel Porto.

The community excursion enabled participants to both explore and discover, taking time to consider the route and surrounding environment in a more measured way. The collective walking merged with public transit to create a dynamic, shared experience. The careful design of the route within the LRT stations, on the train cars, and through downtown Calgary presented intentional opportunities to view and consider. The fast pace of the LRT train contrasted with the slow pace of pedestrian movement, accentuating when and how participants could engage with their surroundings. The timed sketches at LRT stops provided an active means to intentionally look, observe, and record what the participants noticed. Formalized stops on the walk allowed the artists and resource person to share history and discuss context. Along the way, casual conversations emerged between participants and between participants and the artists. As a tangible product of the experience, the individual sketches and composed sketch collages became part of a 'legacy piece', a visual catalog designed by Artist Andrea Legge, documenting all of the eight excursions organized for stakeholders. Becoming part of the community's collective understanding of the environment, the 'legacy piece' continues to be physically accessible in local public libraries and digitally available through the City of Calgary Public Art Program website.

2.4. Found Object Walk, Austin, Texas, USA

As part of a planning process for the South Central Waterfront district, Artist Ann Armstrong led a series of events for community stakeholders to explore this densifying area of downtown Austin. As of 2015, the district was disjointed and without a cohesive identity, yet a string of redevelopment projects were poised to dramatically transform the area. Led by Architect and Planner Alan Holt, City of Austin staff jumpstarted a planning process in hopes of guiding the redevelopment. While the district included many well-loved urban parks, large city blocks and numerous surface parking lots deterred pedestrians and made walkability a primary concern within the car-centric street grid. The district

had few residents, so primary stakeholders for the planning process included: staff and patrons of local restaurants and retail; City of Austin staff (officing in the City's largest office building located in the district); and users of the public parks and spaces, including Auditorium hores, Palmer Events Center, Long Center for the Performing Arts, and Townlake Trail.^{xx}

The *Found Object Walk* was one of Armstrong's five events exploring the district and inviting the public to engage in a creative way. Meeting up at the First Street overpass on the southside of Townlake, Armstrong asked each participant to establish a territory, a portion of the district that could be explored in 30 minutes, and then to set out on foot gathering found objects along the way.^{xxi} These objects might include natural elements (rocks leaves, and grass), trash (food wrappers, parking stubs, and advertisements), and more. A trash bag and disposable latex gloves were provided to aid in the process. Upon their return to the meeting point, participants were instructed to compose a "portrait of this place" using the found objects in 30 minutes using only what they found. White butcher paper became a 3-foot by 3-foot canvas for each of the original compositions. Armstrong explained, "To add a little more context or intent, I encourage people to title their work."^{xxii} One participant, an artist named Emily, titled her collage *81 Cigarettes*, gathering overflowing debris from a nearby construction site (Figure 5). Photographs of the collage process and its outcomes recorded the temporary artworks and were included in the *People's Guide to South Central Waterfront*. The printed, map-like publication captured the creative outcomes of all five community events and Armstrong's research to become an "exploratory tool" available to the public.^{xxiii}



Figure 5: Participants in the Found Object Walk put final touches on their collages. Credit: Ann Armstrong.

The *Found Object Walk* was a vehicle to explore the District and collectively reflect on the environment. Influenced by found object art, comedy improvisational exercises, and land artists, Armstrong shaped the event to be active and engaging for attendees with little to no artistic training.^{xxiv} While Armstrong hoped for a group of 20 to 25 individuals, three participants attended. Looking back, Armstrong questions the messaging for the event, suspecting the title of "found object walk" might not have resonated with non-artists. Also, client efforts to promote the event were lacking and more strategy was needed to consider methods of communication, timing, etc.^{xxv} Regardless of group size, the walk exercise provided for flexibility and freedom to explore on their own, guided by their interests and insights, and the task of gathering gave them purpose and intention in their observations. Following the walk, attendees dialogued with Armstrong and each other about what they saw and found along the way. Each attendee composed their own piece, while sharing ideas and dialoguing about what they found. Armstrong explains, "The goal of these engagements was to help participants slow down and look more closely at the South Central Waterfront. The prompt of finding and arranging found artifacts accomplished this and provided the opportunity for creative output that revealed the realities of this place."^{xxvi}

3.0. CONCLUSION

In pursuit of inclusive, equitable, and resilient communities, community engagement is an essential practice for designers and architects. Walking, as a tool for engagement, is an active mode for deep listening and looking alongside the community, especially helpful to designers coming from outside of the communities in which they work. In contrast to more formal settings, collective walking provides both planned moments and casual encounters within an organized event or meeting. This active approach draws participants out into the built environment landscape to look and listen first-hand - and as they observe - they shape their own perspectives and share thoughts with designers and each other. As highlighted by the three case studies, walking paired with creative-making shapes an engaging, active opportunity for stakeholders to share and contribute to a collective experience and the shaping of the built environment. In pursuit of equity and inclusion, the example projects and their creators foster new ideas and methods designers and architects to engage communities and future research in creative forms of engagement for underserved communities.

ENDNOTES

- ⁱ Henry Liddell and Robert Scott, A Greek-English Lexicon. 'Entry peripatetikos.' Accessed online Oct 13, 2019. <http://archimedes.fas.harvard.edu/cgi-bin/dict?name=lsj&lang=el&word=peripathtiko%2fs&filter=GreekXlit>.
- ⁱⁱ Guy Debord, "Theory of the Derive," *Situationists Anthology* (Berkeley: Bureau of Public Secrets, 1981), 56-60.
- ⁱⁱⁱ Ben Jacks, "Reimagining Walking: Four Practices," *Journal of Architectural Education*. Feb 2004, 7.
- ^{iv} Barbara Tversky, *Mind in Motion: How Action Shapes Thought* (New York: Basic Books, 2019), 150.
- ^v "Transportation Health Impact. Toolkit," *US Centers for Disease Control and Prevention: Healthy Places*, https://www.cdc.gov/healthyplaces/transportation/promote_strategy.htm. Accessed October 28, 2021.
- ^{vi} "Principles of Community Engagement: First Edition." *Centers for Disease Control and Prevention: CDC/ATSDR Committee on Community Engagement*, 1997, 9.
- ^{vii} "IAP2 Spectrum," International Association of Public Participation, <https://iap2usa.org/resources/Documents/Core%20Values%20Awards/IAP2%20-%20Spectrum%20-%20stand%20alone%20document.pdf>, Accessed October 28, 2021.
- ^{viii} Nicole Siesler, "About," City Souvenirs, 2015, <https://citysouvenirs.wordpress.com>, Accessed October 25, 2021.
- ^{ix} "City Souvenirs Walking Tours," Artists Alliance Inc, <https://www.artistsallianceinc.org/cuchifritos-gallery-2/city-souvenirs-walking-tours/>, Accessed October 25, 2021.
- ^x Alexandra Henry, *City Souvenirs Walk* (Film), <https://vimeo.com/141064206>, Accessed October 25, 2021.
- ^{xi} Nicole Siesler, "About," City Souvenirs, 2015, <https://citysouvenirs.wordpress.com>, Accessed October 25, 2021.
- ^{xii} "City Souvenirs Walking Tours," Artists Alliance Inc, <https://www.artistsallianceinc.org/cuchifritos-gallery-2/city-souvenirs-walking-tours/>, Accessed October 25, 2021.
- ^{xiii} Alexandra Henry, *City Souvenirs Walk* (Film), <https://vimeo.com/141064206>, Accessed October 25, 2021. 2:10.
- ^{xiv} Alexandra Henry, *City Souvenirs Walk* (Film), <https://vimeo.com/141064206>, Accessed October 25, 2021. 3:00.
- ^{xv} Alexandra Henry, *City Souvenirs Walk* (Film), <https://vimeo.com/141064206>, Accessed October 25, 2021. 9:40.
- ^{xvi} Alexandra Henry, *City Souvenirs Walk* (Film), <https://vimeo.com/141064206>, Accessed October 25, 2021. 12:03.
- ^{xvii} MDB Insight, *Cultural Plan for Calgary*, 2016, 3. <https://pub-calgary.escribemeetings.com/filestream.ashx?DocumentId=7900>. Accessed October 21, 2021.
- ^{xviii} Sarah Gamble, ed. *Field Station: A Community Project for the Neighbourhoods of Tuscany, Royal Oak, and Rocky Ridge*. 2017.
- ^{xix} Sarah Gamble, ed. *Field Station: A Community Project for the Neighbourhoods of Tuscany, Royal Oak, and Rocky Ridge*. 2017.
- ^{xx} City of Austin, *South Central Waterfront Vision Framework Plan*, 2016, 22. https://www.austintexas.gov/sites/default/files/files/Housing_%26_Planning/South%20Central%20Waterfront/2016%20South%20Central%20Waterfront%20Vision%20Framework.pdf. Accessed October 21, 2021.
- ^{xxi} Ann Armstrong (Public Artist) in discussion with the Author, November 3, 2021.
- ^{xxii} Ann Armstrong (Public Artist) in discussion with the Author, November 3, 2021.
- ^{xxiii} Ann Armstrong, "South Central Waterfront," *Ann-made*, 2015, <https://ann-made.org/section/506466-South-Central-Waterfront.html>, Accessed October 21, 2021.
- ^{xxiv} Ann Armstrong (Public Artist) in discussion with the Author, November 3, 2021.
- ^{xxv} Ann Armstrong (Public Artist) in discussion with the Author, November 3, 2021.
- ^{xxvi} Ann Armstrong (Public Artist) in discussion with the Author, November 3, 2021.

Resilient Sites: Mapping K-12 Schools' Context Biophilic and Energy Performance

Ihab M.K. Elzeyadi¹

¹University of Oregon, Eugene, OR

ABSTRACT: The USGBC has been influential in setting certification process to promote, build, and renovate buildings into LEED™ rated facilities. One of the goals of the LEED rating program is to improve a building's site context parameters and their carbon and energy expenditure as well as their impacts on occupant's transportation and energy behaviors. Due to a lack of evaluation of this certification program, in general, and its sustainable site credits in particular, the effects of these guidelines on building performance and occupant's experiences remain contested. This paper reports on a portion of a larger study related to the impacts of LEED sustainable sites credits achieved on occupant's site behavior of educational environments. The paper specifically focuses on a portion of the study related to the relationship between LEED certification and outdoor environmental quality (OEQ) of K-12 schools and their impact on children's transportation energy expenditures. In addition, the study links sustainable sites strategies to their physical impacts on the environmental performance of school buildings. The specific hypothesis tested is; that children with more livable and connected school sites, more biophilic context-related features, as well as better OEQ strategies, will have better energy and carbon emission expenditure performance and are more connected to their communities than those with poorer school contexts with poor OEQ metrics. This comparative study evaluated the performance of eight LEED/non-LEED, well-matched, schools in the US. For the first study of this scale, we assessed LEED credits earned of schools' land use, and site variables, transportation patterns, indoor/outdoor environmental quality together with their impact on the school's resource operations data, and carbon expenditures. Findings highlight resilient site and buildings context strategies that affect the design and operation of schools. The aim is to deliver evidence-based strategies for siting green schools that impact their overall site and building performance.

KEYWORDS: Resilient Sites, Context Analysis, Outdoor Environmental Quality

INTRODUCTION: READING THE SITE

On October 25th, 2021 Dennis McFadden — a well-respected Southern California architect with 15 years' service on the University of California Santa Barbara's (UCSB) design review committee — resigned in protest to a radical new building concept, which calls for an 11-story, 1.68-million-square-foot structure that would house up to 4,500 students, 94 percent of whom would not have windows in their small, single-occupancy bedrooms leading to a building with no relationship to its site or context (Miranda, 2021). The case for lack of considerations of context analysis and assessment when choosing a building site had multiple implications on building performance and occupant's wellbeing (Elzeyadi, 2021). LEED certification credits for building devote several credits to sustainable sites and considerations of choosing context locations for high-performance buildings. Despite the favorability of this certification process by architects and developers, there is a current knowledge gap in the reliability of findings linking LEED Sustainable Sites credits and livable communities' strategies, and streets engineering interventions impacts on human performance, health, and wellbeing. This problem is magnified in school environments as most previous research has resulted in inconclusive evidence leading to speculative relationships between alternative transportation policies and their application in schools (Elzeyadi, 2008). This knowledge gap is due to three main reasons: First, previous studies that focused on case studies tended to be anecdotal and lacked external validity beyond the case in question or the context of the findings (Kats, 2006). Second, studies that focused on broader strategies studying larger populations—such as transportation policies and education on commuter behavior—used a survey approach with weak internal validity (Hardy et al, 2007). These studies could not confirm a relationship between specific site performance elements, such as the availability of green canopies and bike lanes, and their impact on sustainable commuting behavior (Boarnet et al., 2005; Cash, 1993).

The third, and perhaps the most important gap in knowledge, is the failure of both approaches to uncover the mediational effects between site-related physical elements of the environment and human health. The lack of clear differentiation between the impacts of programs that target physical environmental changes in context use and behavior patterns and programs of an educational nature that address occupant's awareness complicates the applicability of previous findings (CPAHTL, 2005; Klesges et al., 1990). These mediational mechanisms might include but are not limited to, circadian rhythms, body-mass index (BMI) hypertension, physiological effects that help induce alertness, and other mechanisms that impact occupants' performance in buildings (Elzeyadi, 2008).

To overcome limitations in previous studies, this multi-method study targeted this problem through a comparative case study of the site and neighborhood design strategies of four pairs of schools in Oregon, four of which are LEED rated/green schools well-matched with four non-LEED schools within the same districts and having the same social, economic, and organizational variables yet differ in their physical contexts and site parameters. The study assesses the impacts of green school site-planning and performance of the physical environment on students' perceptions in a 4x4 comparative survey design measuring their impacts on commuting behavior, physical activity, and site energy expenditures. Findings and the tools developed from this study could create a market transformation in the way we design, cost-estimate, and operate schools and their site programs in green and livable communities that encourage better levels of activity and active commuting behavior to schools for children and youth.

Based on the previous assumptions, this study started with a general question; Do LEED-rated schools, which achieved sustainable site credits, improve alternative transportation commuting over non-LEED schools? This question was further modified during the field research phase of this study and based on grounded theory epistemology, which resulted in three main research questions, these are:

- 1) How do LEED-rated and non-LEED-rated comparative schools perform? How do these schools compare in terms of energy and water consumption as well as CO2 emissions?
- 2) What impact does the biophilic environment in terms of nature's content surrounding the school site, green areas, green canopies, viewsheds, zoning, and walkability indicators have on commuting behavior to schools?
- 3) What is the carbon and energy expenditure implications related to actual commuting behavior and modes of getting to and from the studied schools?

1.0 SITE BIOPHILIC EXPERIENCE

This study builds on the conceptualization of school environments from a place-based experience perspective (Cotton, 2001). This perspective (Figure 1) relies on the general assumption that green schools are composed of “students” and “schools” on the macro-scale as well as the overall “neighborhood” and systems of settings on the mega-scale. The framework treats students and their school environments as interdependent elements of a system. Student activity and energy expenditures are viewed as both an outcome variable of this system as well as mediational variables that impact students' health as well as physical and academic performance in schools.

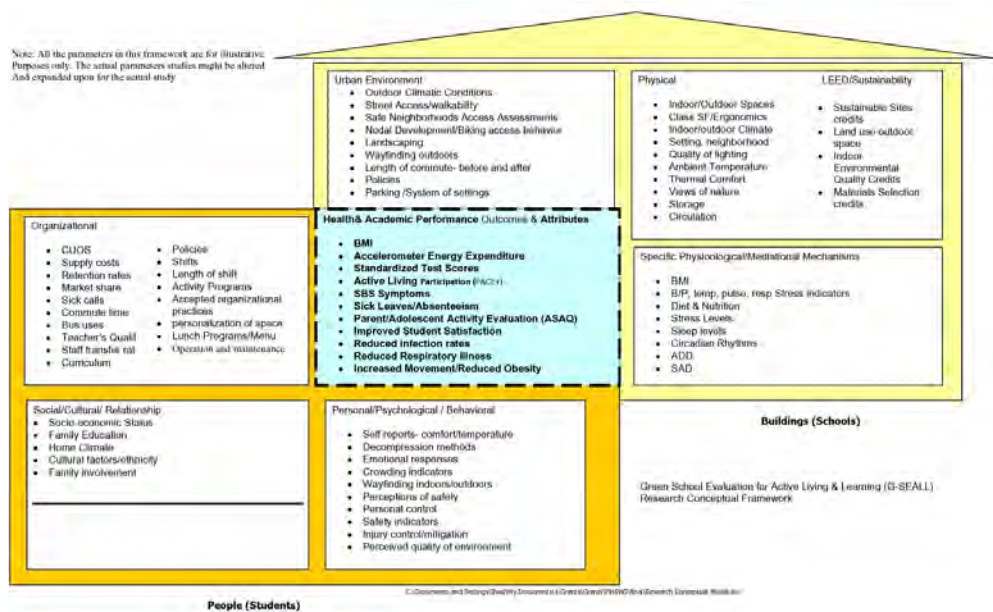

Figure 1: Research Conceptual Framework

In addition to the neighborhood's physical structure, the school site itself is an important determinant of its performance. Due to economic and political reasons, the development of new schools in remote areas is increasing (US EPA, 2003). Zhu and Lee (2009) question whether the Safe Routes to School (SRTS) program measurable impacts on commuting behavior has if the school location and development have not been considered first. Correspondingly, traffic reduction in volume and speed is identified most often as a barrier to walking and bicycling (Hume, Timperio, & Salmon, et al, 2009; Carver, Timperio & Crawford, 2008; Kerr et al., 2006). This is another illustration of how the physical environment directly influences parents' perception of safety and thereby their students' commuting behavior. It is recommended that future studies consider school buildings and site-related factors when accessing the impacts of the site and context surrounding schools on commuting behavior (McMillan, 2007).

1.1. Site nature's dose

Selecting a school site with access to nature to provide biophilic attributes for indoor and outdoor qualities is essential to the health and wellbeing of school children (Li & Sullivan, 2016). Only 13.4% of 424 school districts surveyed in the US in 2006 had the policy to include biophilic site design features when constructing new or renovating existing buildings (Jones, 2006). Furthermore, only 7.6% of these districts had policies or programs that encouraged the use of alternative transportation, such as walking and biking to school. This statistic offers an opportunity to address the decline in the number of school-age children nationwide who commute to school by walking or bicycling from 42% in 1969 to 13% in 2001 (USDOT, 2001). The USDOT and US EPA established several relevant priority areas and guidelines for adopting neighborhood levels physical changes in and around schools that would encourage alternative transportation and enhance livability. Many of these changes such as the presence of sidewalks and bike lanes, access to public parks, tree canopy paths, orientation, viewsheds of nature, and connectivity have all been identified in previous studies as indicators of active living (Cohen, 2007; Kerr et al., 2006; Fulton, 2005; Lee & Moudon, 2004).

The combined effects of these factors have been associated with a lack of activity levels for children both for outdoor as well as indoor activities that promote an active living lifestyle and programs (NRC, 2006). The problem is confounded by a host of health issues in addition to obesity that includes respiratory illnesses, asthma, allergies, and sick building syndrome symptoms. Since such problems are compounded by density as educational facilities have four times the number of occupants per square foot than most offices. Decreasing the prevalence or severity of these health effects on students could lead to higher academic achievements, lower health care costs, reduced sick leave, and shorter periods of illness-impaired performance, resulting in annual economic benefits for the U.S. in the tens of billions of dollars (USGBC, 2007).

To overcome this problem a market transformation program led by the US Green Buildings Council (USGBC) has been influential in setting guidelines and certification processes to promote, build, and renovate schools into LEED™ rated green facilities. The rating system gives schools credits for implementing alternative transportation strategies, sustainable land use, and open space availability, as well as environmental quality credits that promote healthy indoor and outdoor environmental quality (IOEQ) strategies. One of the goals of the LEED Schools rating program is to improve health and students' physical activity in K-12 schools. Due to a lack of evaluation and assessment of this school certification program, however, the effects of these guidelines on students' health and activity levels remain contested. This gap in knowledge related to green schools' design has resulted in low market penetration of these strategies in new school construction, in general, as well as LEED and green schools, in particular (Elzeyadi, 2008).

1.2. Site socio-spatial livability

The intent of the socio-spatial analysis of the school context is to document the physical features and limitations of the school site and routes to school that may influence students' mode of commuting behavior beyond those that were initially assessed during site characteristics analysis. The socio-spatial analysis and livability of a school's site are conducted using onsite observation and site audit survey. Surveyors on bikes would tour the entire 0.5-mile area surrounding the schools to document livability facilitators and inhibitors on-site area surrounding the school. The audits are usually performed in the early morning and mid-afternoon in the same time frame as typical children and parents would commute to and from schools. Surveyors document paths on a map similar to the paths typical commuters would take and record the information on an audit checklist at the same time photographs of the incident and variables are recorded and geo-coded and numbered on a context map. This process document system of activities and the settings where they take place during the day and includes amenities around the sites, playgrounds, coffee shops food establishments, parks, as well as other non-positive attributes that might deter site livability.

1.3 Site energy expenditure

Schools are responsible for the transportation energy use of the people getting to and from them (USGBC, 2007). To date, relatively little attention has been paid to the commuting and occupant's activity component of a school's overall energy footprint, even though transportation energy use can be very significant, especially relative to greenhouse gas emissions. An investigation by the Environmental Building News (EBN, 2007) suggests that averaged nationally, a typical work environment building -including schools- built to the ASHRAE 90.1-2004 energy code will consume nearly 2.4 times as much energy per square foot for occupants commuting to and from the building than the building itself consumes for operation. Should these findings be supported by more thorough peer-reviewed research, there may be a reason to give more weight to location- and context-related measures in the planning, siting, and design of green buildings—and in the priorities represented in green building rating systems. A wide range of factors influences the commuting energy intensity of buildings. These include site nature features, such as tree canopies, parks, orientation, and access to views of nature (Elzeyadi, 2021). In addition to the energy consumption resulting from the transportation energy intensity of schools, their location and the transportation options available to students and teachers also affect their productivity (especially time wasted in traffic), health, commuter and pedestrian safety, infrastructure costs, and ecosystem health (Porter, 2000).

1.4. Site architectural context

The impacts of green schools planning and interventions, however, have not been evaluated systematically in a comparative design to evaluate the impact of green schools on promoting alternative transportation and commuting

behavior. In addition, previous studies that evaluated such parameters' impact on transportation behavior have focused on transportation engineering interventions, such as pinch points, speed reduction bumps, and curb extension impacts only (Hume et al., 2009). Other important parameters such as neighborhood aesthetics, green spaces, tree canopies, attractive architecture, noise, pollution, physical disorder, and presence of other people as key factors in determining walking and biking behavior have not been fully investigated as determinants for an increase of alternative transportation behavior for schools. In addition, the impacts of these parameters on walking and biking behavior are further complicated by parents' perception of these factors (Neckerman, 2009). Additional neighborhood livability metrics, such as land-use density, diversity of building uses and services in the area, availability of public transit and other alternatives to private automobile transportation; distance to public transit, the walkability of the area, suitability for bicycle commuting, and incentives offered to building occupants can impact the health and wellbeing of a site.

2.0 READING THE BUILDING'S CONTEXT - A METHODOLOGY

The study used a multi-method approach to assess the context condition of the eight studied schools. This included mapping, techniques, energy expenditure tracking, and computation, as well as OEQ and IEQ parameters assessments that were data logged over typical equinox weather climate conditions (Figure 2). Geographic Information Systems (GIS) data was analyzed using transportation analysis methods to assess connectivity and walkability as outlined by Schlossberg and Brown (2004). The analysis assessed eleven variables quantifying the pedestrian network including minor and major road density, dead-end density, impedance-based intersection density, and impeded pedestrian catchment area.

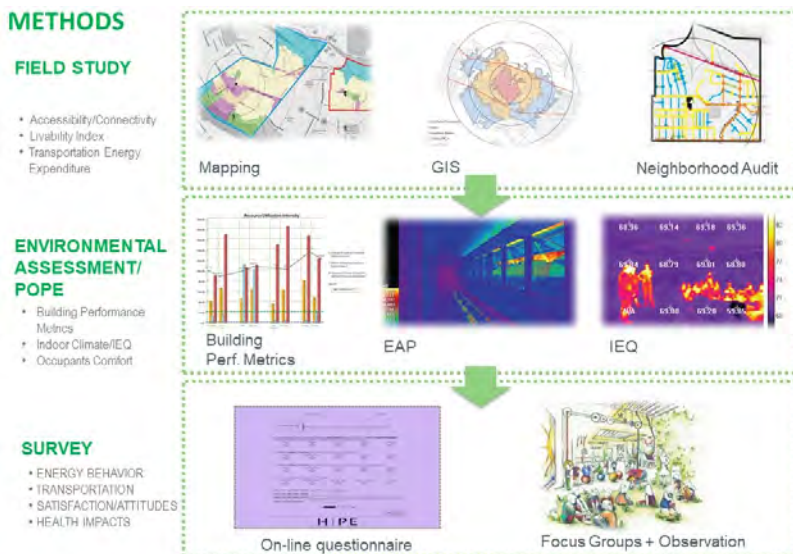

Figure 2: Research Methods and Workflow Diagram

2.1 Natural context

Site As a method for studying people-environment interactions, site observation provides insightful data and context documentation. According to Jorgensen (1989), "...through participation the researcher is able to observe and experience the meanings and interactions of people from the role of an insider" (p. 21). The on-site observation helped in providing a good account of the actual number of students commuting to and from school on a typical day together with their mode of transportation and transportation behavior. In doing so, many techniques were employed. These were: (1) direct or simple observation (behavioral mapping and tracking and physical observation with the researcher's interpretation of the behavior it represents), (3) indirect observations through photography and field notes. Direct observation included techniques were employed by research surveyors to map how children got to and from school. Tools included tally counts, behavioral mapping, tracking, and photography.

2.2 Livability context (socio-spatial)

A mapping procedure was carried out by overlaying Google maps and schools' districts' zoning maps from the city and municipality where the school is located. The environmental variables related to safety, bike and pedestrian amenities, traffic control, and land use were geo-located on the map and coded to document their category. The site context variables were quantified and spatially located then cross-tabulated with walking and biking radii at the 0.5, 1, and 1.5-mile radii all generated from the school. A minimum of two surveyors monitored every access point where children are either dropped off by car or by arriving at school using alternative commuting options (walking, bicycling, or using public transportation). Surveyors observed school commuting attitudes for one hour in the morning drop-off time and one hour in the afternoon pick-up time. The observations took place 30 minutes before the school start time in the morning and lasted for 30 minutes after the time to ensure that any tardiness or late arrival was captured in the data set. In the afternoon, observations started 15 minutes before the school release time and started for 45 minutes past this time to ensure late pick-ups are recorded (Figure 3).

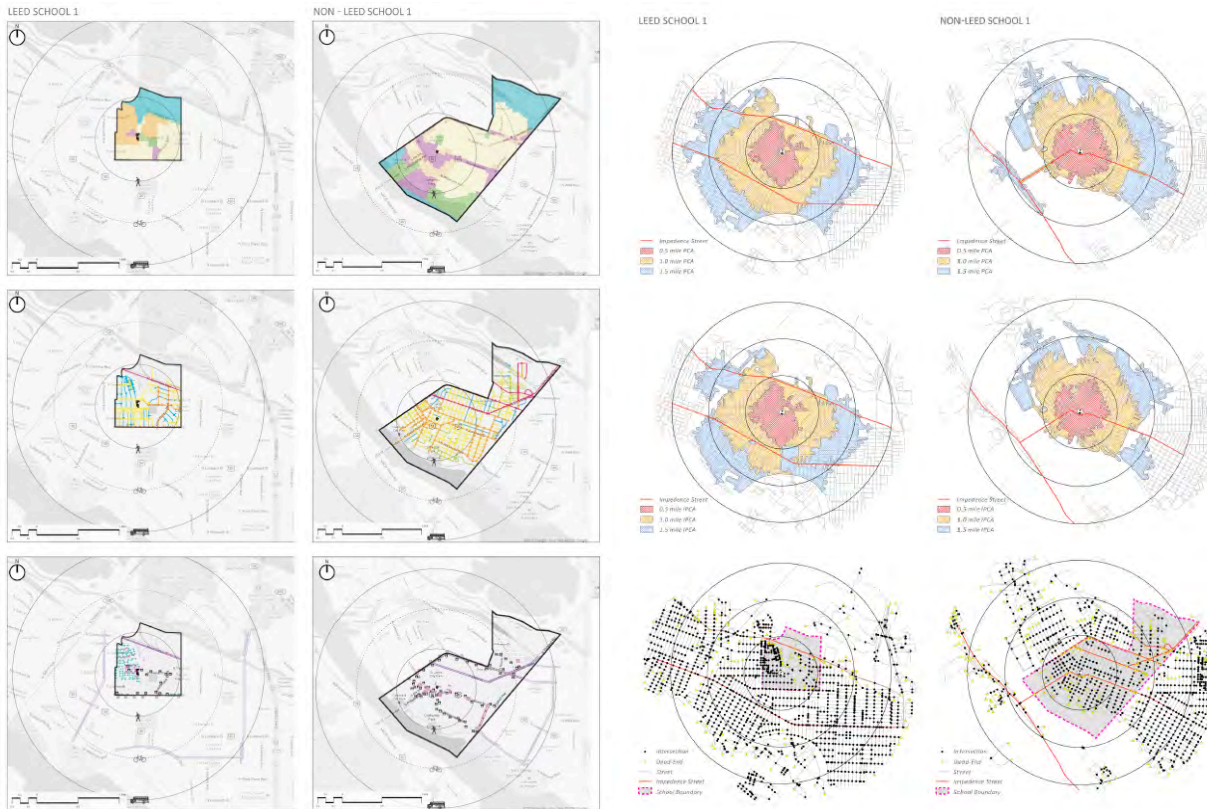

Figure 3: Mapping analysis of the street network, traffic, and amenities (e.g., site # 1)

2.3 Energy context

Analysis of site performance and resource consumption involved the development of transportation energy intensity metrics and baseline data for the studied districts. Data were gathered regarding the physical, organizational, and socio-psychological environmental variables of the study schools. Over one hundred variables were collected from primary and secondary sources in the following categories: climate, site area, building area, cost, occupancy, energy, carbon dioxide emissions, water usage, and LEED score. Over fifty additional variables were measured onsite relating to indoor environmental quality, assessing visual, acoustic, and thermal comfort inside the classroom. Findings from this phase established a broad baseline survey across the different variables and school programs under study. It also can serve as a baseline against which the impact of the proposed project technology transfer and proposed guidelines can be quantified in the future.

2.4 Architectural context

Analysis of site characteristics involved a School-In-Use assessment of the school settings covering the school's architectural variables related to building performance and outdoor space use. A mapping procedure was carried out by overlaying Google maps and schools' districts' zoning maps from the city and municipality where the school is located. The environmental variables related to the site and building history from tax maps, square footage and volume, envelope area, outdoor paved and un-paved areas, building density footprint and surface area, playground areas, classroom window to wall ratio (WWR), building's material insulation values, envelope properties, skylights, and daylight area. The site architectural context variables were quantified and spatially located then cross-tabulated with walking and biking radii at the 0.5, 1, and 1.5-mile radii all generated from the school's site (Figure 4).



Figure 4: Study settings analyzed based on their architectural quantities and qualities

3.0 A COMPARATIVE CASE STUDIES ANALYSIS OF LEED SCHOOLS

3.1. LEED School nature and livability contexts

The data gathered on 8 schools included in the data set was comprehensive in scope and included 350 separate variables for each of the 8 schools. A standard data reduction technique was used to summarize and combine the variables into scales that could be used to describe the eight sites in a more parsimonious manner. In most cases factor analysis was used to reduce the data, employing a varimax rotation, and saving the factor scores. In a few cases, the inspection of correlation matrices, reliability coefficients, and summated scales was performed. In all cases we examined the scores on the variables for each site and compared the average scores for the LEED and non-LEED sites, using t-tests and Cohen’s d, a measure of effect size. After developing the various summary measures these were correlated with the results from the transportation audit using correlation coefficients.

The eight sites in the study were carefully matched to ensure that they were similar in socio-demographic and community characteristics. Figure 5 provides a comparison between each school’s site street density and street engineering interventions as compared to active transportation and livability metrics. In general, higher bars indicate higher street densities and more connectivity as well as more engineering and architectural interventions to promote livability. These interventions were strongly correlated with more walkability indices and students’ active behaviors. Some exceptions, such as non-LEED School #3, where many of the architectural amenities and livability features on the site are present yet did not yield active behavior and higher walkability metrics by the students. This is related to the lack of connectivity and lack of natural features, such as parks and tree canopies in the neighborhood as well as an increased number of wide impeding streets that present barriers to neighborhood walkability and active behaviors (Figure 5). An ideal case comparison is presented in figure 6, which shows a comparison of two school sites with the one on the right yielding much more active transportation and walkability. This could be attributed to the small school catchment area with most households situated within the 0.5-mile radius, which is ideal for active commuting and the presence of nature surrounding the school site as well as within the walking and biking routes to and from the school.

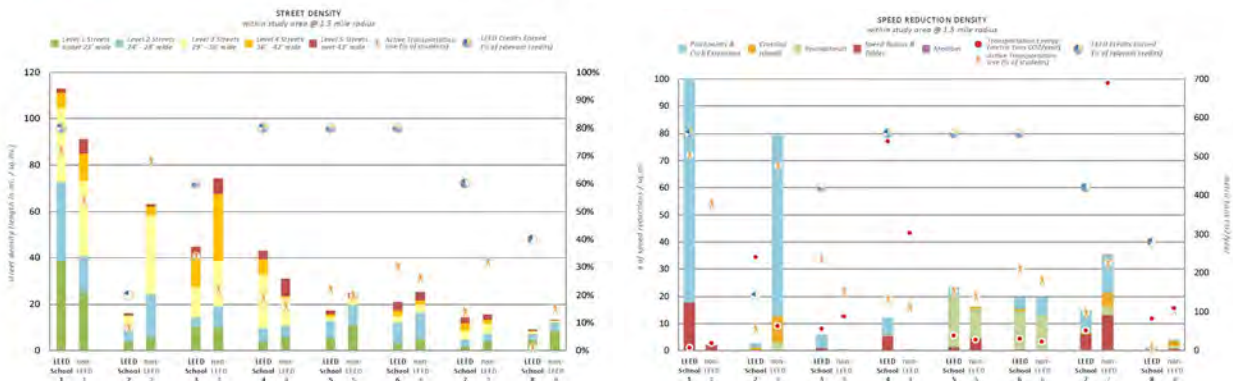

Figure 5: Study settings analyzed based on their socio-spatial qualities and street engineering interventions

3.2. LEED school's energy and GHG expenditure

The results indicate clear patterns for sites 1, 2, and 3, with the LEED schools having lower scores than the non-LEED schools. In other words, as expected, the LEED schools at these three sites had lower energy use (Figure 6). Results differed markedly, however, for the schools at site 4, where the LEED school had strikingly higher values on both factor 1 and the measure of CO2 emissions. It is for this reason that the second grouping of schools has been included, with the “LEED” school in site 4 being grouped with the non-LEED schools. This highlights the magnitude of commuting energy expenditure, where the LEED school 4 site is in a suburban context requiring busing and/or driving to school. This led to increased carbon emissions and energy expenditure related to the site conditions despite having the building performing within similar LEED schools’ benchmarks.

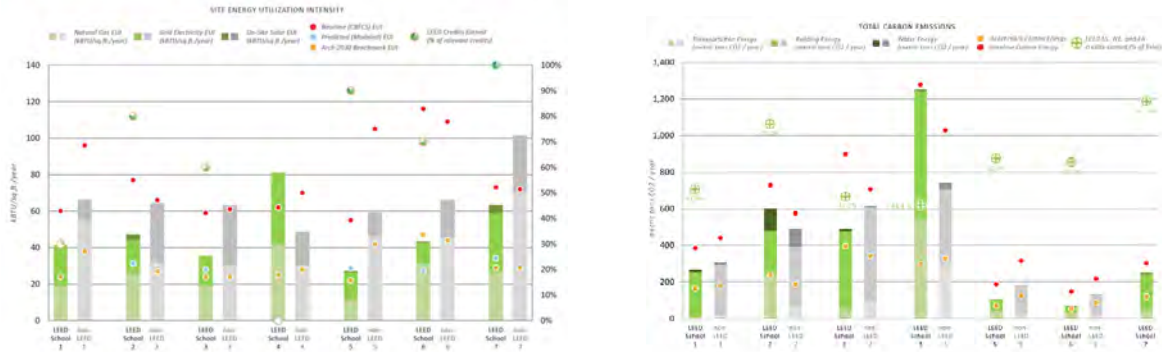

Figure 6: LEED SS credits earned and total Carbon emissions across the eight pairs of schools

3.2. LEED schools’ architectural contexts

Table 2 summarizes data and site layout characteristics of the buildings and sites of the eight schools. Two sets of factors are included. The first (labelled “1” in Table 2) involves measures based on square footage and volume. Higher scores on factor 1a indicate a larger footprint and surface area, higher scores on factor 1b indicate more playground area and more classroom window to wall ratio (WWR), and higher scores on factor 1c indicate more skylights and daylight area. The results for the second analysis of site characteristics used the data reflecting the percentage of area. Higher scores on 2a represent higher WWR, classroom sf, daylight efficiency, and classroom daylight factor values; and higher scores on 2b represent sites with built-up and paved areas as a higher percentage of the total area. Data for each site are in the top part of Table 2, while data for the groups of sites are in the second and third panels. There are few patterns between the LEED and non-LEED schools, with LEED schools sometimes having both the highest and lowest scores (Figure 7). While the LEED school sites did not perform in consistent manner related to their LEED status, it is important to note that those sites with richer and more efficient architectural contexts were correlated to better livability and walkability metrics.

Table 2: architectural and site characteristics coefficients

	1a	1b	1c	2a	2b
Site 1 - LEED	-1.55	-.66	.94	-.09	.58
Site 1 - Non-LEED	-1.04	1.11	.17	-.30	1.73
Site 2 - LEED	-.25	.57	-.41	-.23	-.20
Site 2 - Non-LEED	-.22	.63	-.44	-.39	-.55
Site 3 - LEED	1.50	.27	1.94	2.29	-.74
Site 3 - Non-LEED	.35	-1.34	-.74	-.27	-1.22
Site 4 - LEED	-.98	.84	-1.17	-.60	.05
Site 4 - Non-LEED	.23	-1.42	-.29	-1.01	-1.15
Averages of LEED & Non-LEED Schools (n = 4.4)					
Mean - LEED Schools	.17	.26	.32	-.34	.02
Mean - Non-LEED Schools	-.17	-.26	-.32	-.34	-.02
s.d. LEED Schools	1.36	.65	1.38	1.31	.55
s.d. non-LEED Schools	.63	1.32	.37	.54	1.42
t-value	.45	.70	.91	.97	.06
prob. (2 tail)	.67	.52	.42	.37	.96
Cohen's d	.34	.52	.74	.74	.05
Averages of LEED & Non-LEED (n = 5.3)					
	1a	1b	1c	2a	2b



Figure 7: Study settings analyzed based on their architectural neighborhood amenities

4.0 CONCLUSIONS: QUANTIFYING THE BUILDING'S SITE PERFORMANCE

This study investigated the relationship between schools' physical site and neighborhood conditions in green LEED and non-LEED schools in Oregon and their impact on active transportation behavior by school students. It also places a value on the impact of the physical environment of school sites and their surrounding neighborhoods by correlating

their degree of availability and the number of sustainable site LEED credits earned to commuting behavior, energy, and carbon expenditures of school sites. Following a triangulation of research methods and extensive data collection and analysis procedures, the study's results positively supported correlations showing that changes in the built environment strongly influence active travel patterns. Even though there was no clear pattern of difference in activity pattern between the groups of LEED and non-LEED schools, there were numerous associations of activity with other LEED credits earned that are specific to sustainable sites.

The differences are not trivial, especially concerning the school boundary areas, suggesting that smaller boundary areas of schools within the 0.5-mile radius are positively correlated with increased active transportation. Similarly, the school's footprint affected transportation patterns with a smaller footprint, built up and paved areas showing positive correlation with and lower levels of CO₂ emissions. As would be expected, most of the measures related to the walkability of surrounding streets were associated with the percentage of travel that was active. Active travel was a more common transportation engineering intervention in the form of easier-to-navigate intersections for street widths between 20'-28', more medians, roundabouts, islands, and pinch-points, and curb extensions. Dead-ends streets show lower connectivity rates of the neighborhoods and reduced walkability and bicycling behavior. This was interesting to note that these sites have earned higher walk scores and were associated with LEED and green schools. A finding that could impact the LEED revision and walk scores indicators used to calculate such scores. Active travel was also more common in sites that include more amenities and support for pedestrians including more marked crosswalks at .5 miles, bike/pedestrian signals, bike racks, bus shelters, and bus stops that were all associated with more active travel. It is interesting to note that the study also confirmed previous findings regarding correlations between active transportation and certain land-use zoning. Active travel was less in neighborhoods with low-density residential, light industrial, agricultural, or un-zoned areas. Active transportation benefited from livability metrics on the neighborhood scale such as more planters, attractive architecture, art and activities, more benches for sitting, and more access to nature.

The better-performing school sites in terms of active transportation patterns show strong correlations with physical indices related to street connectivity, livability metrics in addition to LEED SS credits earned. This could suggest the possibility of additional inputs to improve the SS credits of the LEED certification. The findings of the study suggest a strong correlation between green LEED schools' site and land use conditions, the sustainable site achieved credits, and their impact on quantifiable transportation behavioral outcomes of students in the studied schools. This information will be invaluable to schools' designers and planning professionals in designing green schools for future generations of healthy students.

REFERENCES

- AAP American Academy of Pediatrics (2003). School health. Pp. 137-146 in Red Book: 2003. Report of the Committee on Infectious Diseases. L. Pickering, C. Baker, G. Overturf, and C. Prober, eds. Elk Grove Village, IL: AAP.
- Berry, M.A. 2005. Educational Performance, Environmental Management, and Cleaning Effectiveness in School Environments. Available at <www.ashkingroup.com>.
- Blondeau, P., Iordache, V., Poupard, O., Genin, D., and Allard, F. 2005. Relationship between outdoor and indoor air quality in eight French schools. *Indoor Air* 15:2-12.
- Bloom, B., and Tonthat, L. 2002. Summary health statistics for U.S. children: National health interview survey, 1997. *Vital Health Stat. Series 10*. Jan.(203):1-46.
- Boarnet, M.G., Anderson, C.L., Day, K., et al. (2005). Evaluation of the California Safe Routes to School legislation: Urban form changes and children's active transportation to school. *American Journal of Preventive Medicine*, 28, 134-140.
- Burgeson, C.R., Wechsler, H., Brener, N.D, et al. (2001). Physical education and activity: Results from the School Health Policies and Programs Study 2000. *Journal of School Health*, 71, 279-93.
- Carver, A., Timperio, A., and Crawford, D. (2008). Neighborhood Road Environments and Physical Activity Among Youth: The Clan Study. *Journal of Urban Health*. 85(4): 532-544.
- Cash, C.S. 1993. Building condition and student achievement and behavior. Unpublished doctoral dissertation. Blacksburg, VA: Virginia Polytechnic Institute and State University.
- Cohen, D.A., McKenzie, T.L., Sehgal, A., Williamson, S., Golinelli, D., and Lurie, N. (2007). How do parks contribute to physical activity? *Am J Public Health*. 97:509-514.
- Cotton, K. 2001. New Small Learning Communities: Findings From Recent Literature. Portland, OR: Northwest Regional Educational Laboratory. Available at <www.nwrel.org/scpd/sirs/nslc.pdf>.
- CPAHTLC (Committee on Physical Activity, Health, Transportation, and Land Use). (2005). Does the built environment influence physical activity? Examining the evidence. (Special Report 282). Washington, DC: Transportation Research Board/Institute of Medicine. Retrieved January 11, 2005 from http://www.trb.org/news/blurb_detail.asp?id=4536.
- Daisey, J.M., Angell, W.J., and Apte, M.G. (2003). Indoor air quality, ventilation, and health symptoms in schools: An analysis of existing information. *Indoor Air* 13:53-64.
- Davison, K.L., Andrews, N., White, J.M., Ramsay, M.E., Crowcroft, N.S., Rushdy, A.A., Kaczmarek, E.B., Monk, P.N., and Stuart, J.M. (2004). Clusters of meningococcal disease in school and preschool settings in England and Wales: What is the risk? *Arch. Dis. Child*. 89:256-260.

- EBN (2007). Environmental Building News, Volume 16, No. 9, September 2007.
- Eisenmann JC. Strath SJ. Shadrack D. Rigsby P. Hirsch N. Jacobson L. Validity of uniaxial accelerometry during activities of daily living in children. *European Journal of Applied Physiology*. 91(2-3):259-63, 2004 Mar. Unique Identifier: 14569402.
- Elzeyadi, I. (2003). Environmental Quality - Shaping Places for People: A Systemic Framework for Conceptualizing People and their Workplaces. In: *Shaping Places for People: Proceedings of the Environmental Design Research Association EDRA 34th Conference*. May 22-26, Minneapolis, Minnesota, pp. 71- 79.
- Elzeyadi, I. (2008). Healthy Schools: A conceptual framework for an evidence based design guidelines. Unpublished manuscript from a meta-analysis of green schools impacts on the triple bottom line. Eugene, OR: University of Oregon.
- Ewing, R. (in press). School location and student travel: Analysis of factors affecting mode choice. *Transportation Research Record*.
- Fulton, J.E., Shisler, J.L., Yore, M.M., and Caspersen, C.J. (2005). Active transportation to school: findings from a national survey. *Res Q Exerc Sport*. 76(3):352-357.
- Gomez, J.E., Johnson, B.A., Selva, M., et al. (2004). Violent crime and outdoor physical activity among inner-city youth. *Preventive Medicine*, 39, 876-881.
- Hardy LL. Booth ML. Okely AD. (2007). The reliability of the Adolescent Sedentary Activity Questionnaire (ASAQ). *Preventive Medicine*. 45(1):71-4, 2007 Jul.
http://www.acaorn.med.usyd.edu.au/streams/activity/ASAQ_Questionnaire.pdf
- Heschong, L; Elzeyadi, I & Knecht, C, (2001). Re-Analysis Report: Daylighting in Schools, Additional Analysis. New Buildings Institute, White Salmon, WA.
- Hume, C., Timperio, A., and Salmon, J., et al. (2009). Walking and Cycling to School: Predictors of Increases Among Children and Adolescents. *American Journal of Preventative Medicine*. 36(3): 195-200.
- Illinois Healthy Schools, (2003). Apparently Size Doesn't Matter: Two Illinois School Districts Show Successful IAQ Management. *School Health Watch*, Summer 2003. http://healthyschoolscampaign.org/news/newsletter/2003-summer_HSC-newsletter.pdf Also see: US Environmental Protection Agency. "IAQ Tools for Schools," December 2000 (Second Edition). Available at: <http://www.epa.gov/iaq/schools/>
- Institute of Medicine. (2006). *Progress in Preventing Childhood Obesity: How do We Measure Up?* Washington DC: National Academy of Sciences.
- Jackson, R., and Tester, J. (2008). Environment shapes health, including children's mental health. *J Am Acad Child Adolesc Psychiatry*. 47(2):129-131.
- Jorgensen, D. (1989). *Participant Observation: a Methodology for Human Studies*. Newbury Park: Sage.
- Kats, G. (2006). *Greening America's Schools: costs and benefits*. A Capital E Report. Available at www.cap-e.com.
- Kats, G. et al. (2003). *The Costs and Financial Benefits of Green Buildings: A Report to California's Sustainability Task Force*. October 2003. Available at www.cap-e.com.
- Kerr, J., Rosenburg, D., Sallis, J.F., Saelens, B.E., and Frank, L.D. (2006). Active commuting to school: associations with environment and parental concerns. *Med Sci Sports Exerc*. 38(4):787-794.
- Klesges, R.C., Eck, L.H., Hanson, C.L., et al. (1990). Effects of obesity, social interactions, and physical environment on physical activity in preschoolers. *Health Psychology*, 9, 435-449.
- Lee, C., and Moudon, A. (2004). Physical activity and environment research in the health field: Implications for urban and transportation planning practice and research. *Journal of Planning Literature*. 19:147-181.
- Levine, A.S., Kotz, C.M., & Gosnell, B.A. (2003). Sugars and fats: The neurobiology of preference. *Journal of Nutrition*, 133, 831S-834S.
- Li, D. and Sullivan, W. (2016). Impact of views to school landscapes on recovery from stress and mental fatigue. *Landscape and Urban Planning* 148: 149-158.
- Mattocks C. Leary S. Ness A. Deere K. Saunders J. Tilling K. Kirkby J. Blair SN. Riddoch C. Calibration of an accelerometer during free-living activities in children. *International Journal of Pediatric Obesity*. 2(4):218-26, 2007. Unique Identifier: 17852552.
- McGinn, A., Evenson, K., Herring, A., et al. (2007). Exploring Associations Between Physical Activity and Perceived Objective Measures of the Built Environment. *Journal of Urban Health*. 84(2): 162-184.
- McMillan, T.E. (2007). The relative influence of urban form on a child's trip to school. *Transportation Research Part A: Policy and Practice*. 41(1):69-79.
- Miranda, C. (2021). Dear UC Santa Barbara: Don't let a petulant billionaire build a prison dorm on your campus. *LA Times*, published on November 1, 2021. <https://www.latimes.com/entertainment-arts/story/2021-11-01/charlie-munger-designs-uc-santa-barbara-windowless-dorm-billionaire-prison-dorm> downloaded on November 1st, 2021.
- National Research Council (NRC)(2007). *Green schools : attributes for health and learning*. Washington, DC : National Academies Press.
- Neckerman, K.M., Lovasi, G.S., Davies, S., Purciel, M., Quinn, J., Feder, E., et al. (2009). Disparities in Urban neighborhood conditions: Evidence from GIS measures and field observation in New York City. *Journal of Public Health Policy*. 30:264-285.
- Ogden CL, Carroll MD, Curtin LR, McDowell MA, Tabak CJ, Flegal KM. (2006). Prevalence of overweight and obesity in the United States, 1999-2004. *Journal of the American Medical Association*; 295(13):1549-1555.

- Pabayo, R. Gauvin, L., Morency, P., Barnett, T.A., Nikiema, B., and Seguin, L. (2006). Understanding the determinants of active transportation to school among children living in poverty: Evidence of environmental justice from the Quebec Longitudinal Study of Child Development. Centre de recherche du Centre hospitalier de l'Université de Montréal.
- Prochaska, J.J., Sallis, J.F., & Long, B. (2001). A physical activity screening measure for use with adolescents in primary care. *Archives of Pediatric and Adolescent Medicine*, 155, 554-559.
<http://www.drjamessallis.sdsu.edu/PAMeasureinfo.pdf>
- Puyau MR, Adolph AL, Vohra FA, Butte NF. Validation and calibration of physical activity monitors in children. *Obesity Research*. 10(3):150-7, 2002 Mar. Unique Identifier: 11886937. [erratum appears in *Obes Res*. 2006 Mar;14(3):528].
- Raat, H., Botterweck, A.M., Landgraf, J.M., Hoogeveen, W.C., and Essink-Bot, M.L. (2005). Reliability and validity of the short form of the child health questionnaire for parents (CHQ-PF28) in large random school base and general population samples. *J Epidemiol Community Health*. 59:72-82.
- Sallis, J.F., Conway, T.L., Prochaska, J.J., et al. (2001). The association of school environments with youth physical activity. *American Journal of Public Health*, 91, 618-620.
- Sallis, J.F., McKenzie, T.L., Conway, T.L., et al. (2003). Environmental interventions for eating and physical activity: A randomized controlled trial in middle schools. *American Journal of Preventive Medicine*, 24, 209-17.
- Schmitz KH, Harnack L, Fulton JE, Jacobs DR Jr, Gao S, Lytle LA, Van Coevering P. Reliability and validity of a brief questionnaire to assess television viewing and computer use by middle school children. *Journal of School Health*. 74(9):370-7, 2004 Nov. UI: 15656264.
<http://www.cdc.gov/HealthyYouth/yrbs/pdf/questionnaire/2009MiddleSchool.pdf>
- Staunton, C.E., Hubsmit, D., & Kallins, W. (2003). Promoting safe walking and biking to School: The Marin County success story. *American Journal of Public Health*, 93, 1431-1434.
- Strong, W.B., Malina, R.M., Blimkie, C.J., Daniels, S.R., Dishman, R.K., Gutin, B., et al. (2005). Evidence based physical activity for school-age youth. *J Pediatr*. 146(6):732-737.
- Timperio, A., Crawford, D., & Telford, A., et al. (2004). Perceptions about the local neighborhood and walking and cycling among children. *Preventive Medicine*, 38, 39-47.
- Trost SG, Ward DS, Moorehead SM, Watson PD, Riner W, Burke JR (1998) Validity of the computer science and applications (CSA) activity monitor in children. *Med Sci Sports Exerc* 30:629-633.
- United States. Congress. Senate. Committee on Environment (2004). *Green schools: environmental standards for schools*. Washington, DC : U.S. G.P.O.
- US Environmental Protection Agency. (2003). *Travel and Environmental Implications of School Siting*. Washington, DC: US Environmental Protection Agency.
- USGBC (2007). *A National Green Building Research Agenda*. USGBC Research Committee. Washington, DC: U.S. Green Buildings Council.
- Whitt-Glover, M.C., Taylor, W.C., Floyd, M.F., Yore, M.M., Yancey, A.K., and Matthews, C.E. (2009). Disparities in Physical Activity and Sedentary Behaviors Among US Children and Adolescents: Prevalence, Correlates, and Intervention Implications. *Journal of Public Health Policy*. 30:309-334.
- Zhu, X., and Lee, C. (2009). Correlates of Walking to School and Implications for Public Policies: Survey Results from Parents of Elementary School Children in Austin, Texas. *Journal of Public Health Policy*. 30:177-202.
- Wilson, E. 1984. "Biophilia: The Human Bond with Other Species." Cambridge, MA: Harvard University Press.

'Configurational' Accessibility of Healthcare Facilities in Dammam, Saudi Arabia: A Space Syntax Study

Ahmed A. Alrashed¹, Saif Haq²

¹Imam Abdulrahman Bin Faisal University, Dammam, SAUDI ARABIA

²Texas Tech University, Lubbock, TX

ABSTRACT: 'Configurational' accessibility of healthcare buildings is an important factor for a healthy population and is an important cue to the new social awareness regarding 'right to health'. With the increase of oil revenue and implementation of national health plans, Saudi Arabia has made large investments to health services and has commissioned many clinics and hospitals in different cities. The purpose of this research is to explore the configurational accessibility of the healthcare facilities in Dammam with special reference to three healthcare facilities that include the 350-bed King Fahad Specialist Hospital (KFSH). A detailed accessibility study of KFSH is also provided. Configurational accessibility are the *possibilities* of access from all locations. It is a function of layout, and layout modulates where one might go, either directly from adjacent spaces, or through other intermediary spaces. This has been modelled with space syntax, taking axial and segmented lines, and considering topological, metric, and geometric parameters. The methodology produces different accessibility values based on connection characteristics and distance considerations. The entire city of Dammam was evaluated separately and then from the point of view of three selected healthcare facilities. In these analyses, locations of *all* the healthcare facilities in the city were mapped. The results were vetted by comparing with previous research findings and onsite observations. This study has revealed that almost all the health facilities are located within an 800-meter or a 10-minute walking distance in all neighborhoods. This supports the expressed intention of the Saudi health policies to provide easy access to healthcare to all citizens. This is further investigated in three select medical facilities. Regarding KFSH, the campus is well related to the larger city and is accessible from many parts, making it an easy destination to get to. Inside the campus, most of the entrances of the main building have easy accessibility, but some difficult ones were also identified. More critically, issues with entrances to other medical buildings were detected. This research is expected to be a beginning source of understanding configurational accessibility in public health studies.

KEYWORDS: Accessibility, Public Health, Space Syntax, Hospital, Saudi Arabia

INTRODUCTION

Healthcare sector is an important domain that impacts the global population and is closely linked to the development of any country. It also plays a crucial role in how a country is perceived in maintaining economic stability (Black, Ebener, Aguilar, Vidaurre, and El Morjani 2004). In this regard, access to health care by the population is a critical concern for all countries because it significantly contributes to a healthy population. Geographic accessibility, often referred to as spatial or physical accessibility, is concerned with the complex relationship between the spatial separation of the population and the locational aspects of healthcare facilities as understood by its connection network (Shengelia et al. 2003). It might be easy to understand that the level of public health of a population might be affected negatively by the distance (or access) to health care services, yet there remains limited quantitative information regarding this impact (Guagliardo 2004). Measuring physical accessibility to healthcare contributes to extensive understanding of the performance of the health system and facilitates the development of evidence-based health policies (Black et al. 2004). In this paper, 'configurational' accessibility is the focus. It is defined as a physical attribute that considers all pathways that exist between all possible origins and destinations, and is evaluated by the theories and methodologies of Space Syntax (Hillier 1984, 1996).

1.0 HEALTHCARE IN SAUDI ARABIA

The inclusion of 'state-of-the-art' healthcare facilities is a significant feature of the national development of Saudi Arabia. This has been an important aspect since the first development plan in 1970 (Alkahtani 1991). The discovery of oil in Dammam substantially changed the country's economy, which affected its urban development, education, social benefits, and healthcare, among others (Mubarak 2004). Saudi Arabia is experiencing rapid urbanization and a swift increase in population. Healthcare services have been given a high priority by the government (Gallagher 2002), and the public sector with its oil-revenue resources and central planning is the financial provider for the Saudi health system (Al-Yousuf, Akerele, and Al-Mazrou 2002).

As part of the implementation of National Development Plans, the Saudi Government allocated a large amount of

money to health service provisions in line with its policy of providing health care that would be accessible to all the population free of charge. Healthcare is considered a “right”, i.e. health rights are basic human rights. The right of a person to health care is stipulated in Articles 27 and 31 of the Basic Laws of Saudi Arabia, which highlight the provision of health care in emergency, sickness, disability, and old age for all citizens. In 2006, a Saudi Patient’s Bill of Rights (PBR) was published by the Ministry of Health that affirms these health rights in its manual of policies and processes, and is further emphasized by periodic circulars (Ministry of Health, 2016; Al-Amoudi 2017).

Optimizing access to healthcare services requires fairness in the national delivery of health care facilities and equity in accessibility of citizens and health professionals, including transport to services and providers (Almalki, Fitzgerald and Clark, 2011). Almalki, Fitzgerald and Clark (2011) has stated that in order to improve access to services of health care in all areas of the country, a comprehensive strategy for the redistribution of health care services, involving public health care centers, general hospitals, specialist hospitals, and health professionals, should be adopted by the Minister of Health. One aspect that has not been discussed is locational characteristics. This is another way of considering access to healthcare and is understood by the relationship of the facility with all other spaces in the neighborhood or the city. This is the focus of this paper and uses Space Syntax methodology to evaluate this kind of accessibility.

2.0 SPACE SYNTAX

Space Syntax has studied the phenomenon of configurational characteristics regarding accessibility, and has proposed a robust method of measuring configurational accessibility based on identification of circulation spaces and their connection characteristics with one another (Hillier 1984, 1996). It is built on two ideas-- the objectivity of space itself, and the user’s intuitive engagement with it. With its focus on space, Syntax is a theory of buildings’ and cities’ layout structure. It looks at plan drawings as a set of unit spaces connected to one another -- either directly to adjacent spaces, or through a series of intermediate spaces to other spaces beyond, examines these connections, and on that basis assigns numerical measures to each space. The analysis provides quantitative measurements of individual spaces and of the whole layout (Haq 2012). In other words, Space Syntax attempts to mathematically articulate the configurational properties of space that users intuit, as expressed in the way they create specific spatial patterns in buildings and cities. Configuration in Space Syntax does not mean simply adding up the relations between pairs of spaces but trying to give an image of how a whole complex of relationships affect one other to create an accessibility structure (Hillier 2005).

Configuration may be measured for any kind of space considerations. However, Space Syntax only uses a set of predefined unit spaces in its analysis. These are convex space, axial line (Hillier and Hanson 1984), and segmented line (Turner 2001). An ‘axial map’ is set of the longest and fewest lines that can be drawn to cover all the convex spaces of a layout. It is most widely known and is the prevalent unit in literature (Hillier and Hanson 1984). Axial lines are used when studying movement (Hillier et al. 1983). In this paper these has been used to study a large hospital campus. Another form of unit space is a segmented line. Segments are formed by chopping the original axial lines at each junction into smaller individual parts (Turner 2001). This kind of analysis is employed here for city scale assessments.

Space Syntax uses various techniques to represent space as a relational spatial structure. Several measures can identify the relationships between the spatial units. By using these techniques to measure layouts, Space Syntax scholars believe they can capture the spatial and thereby the functional differences in diverse plans. Two of these measures are *Integration* and *Choice*. In simple words, integration measures how easy it is to go from one space to all other spaces of a network, indicating the potential of a space to act as destinations, or for generating to-movement. As such, one may expect to find more communal activity and many people in integrated or ‘close’ spaces. In contrast, choice measures how likely it is for a space to be chosen on shortest paths between all origins and destinations in a network, indicating its potential for through-movement (Hillier and Iida 2005). This means that more people may be expected to pass through high choice value spaces. Simply stated, in *to-movements*, people want to maximize their accessibility to all spaces, while in *through-movements*, people use a space to get to another space with the minimum effort.

2.1. Empirical findings from Space Syntax literature

Empirical studies using a Space Syntax approach to the representation and measurement of configuration have identified a general connection between configuration and various human activities, especially movement and occupancy. Studies by Peponis et al. (1989) in six Greek towns; Hillier and his colleagues (1987a) in different areas of Barnsbury in inner North London; Hillier et al. (1993) in King’s Cross Area, London; Penn and Dalton (1994) in London, Rashid and Bindajam (2014) in Jeddah, Saudi Arabia and many others have examined the layout of public open space networks within cities quantified by the analysis of the axial maps, against the occupancy and movement in those spaces. The general findings were that the integration value of streets was the most common and reliable predictor of movement density. These studies in urban areas have confirmed that the syntactic properties of spatial configuration are linked to the encounter probabilities of people and vehicles. In almost all the urban cases available, including the ones mentioned here, results indicate that there is a positive and significant correlation between space syntax derived configurational variables and both pedestrian and vehicular movement. Such findings were quite pervasive and has prompted Hillier et al., (1993) to develop their theory of ‘natural movement’ that essentially states that all else being equal, movement in cities can be understood by its configurational characteristics.

Regarding complex buildings, researchers such as Haq and Zimring (2003) and Haq (2003) in three large hospitals in the United States; Lu and Bozovic (2009) in three complex urban hospitals in Nanjing, China; Selota and Borgianni (2016) in three complex hospitals in Tuscany Region, Italy have published empirical studies using Space Syntax to measure the environment as a set of predictor variables for specific behavior, such as visitor movement in hospital public areas. These studies investigated the distribution of visitors and stated that the density of moving people correlated well to integration values. Also, areas with higher integration values appear to attract more visitors when in doubt about where to go. In a hospital building, the distribution pattern of visitors is similar to that of pedestrians in an urban setting, i.e., more integrated spaces have more people on average.

Hillier et al. (2007, 2010) asked if the metric analysis of cities represent real patterns. They looked closely at London and surmised at a theoretical level a strong agreement between functional differences and the patches identified. Later, Haq and Berhie (2018) commented that the relationship between them might be suggestive. In 2020 Haq investigated a few gridlike West Texas cities in the United States. He calculated the global structure using 'choice' values at radius 'n'; the local structure with metric analysis at radius '1600' meter (about one mile). They demonstrated that local patches highlight an accessible central area of every subdivision. More importantly, there is a neighborhood amenity, either an elementary school or a park located in all the central areas identified (patches). Moreover, all of these are also connected to a global core system. This indicates that the identified central patches are not only the vibrant center of neighborhoods (living centers) but are also well connected to the city structure.

3.0 METHODS

This paper is an investigation of the configurational access patterns of healthcare facilities in Dammam, Saudi Arabia. It starts by accepting the basic concepts, computerized methods and previous empirical findings of Space Syntax (Hillier and Hanson 1984). It is done on two levels – access patterns of the city, and access patterns inside the KFSH campus. On a more important note, it explores the locational characteristics of all healthcare facilities in Dammam to understand how they are connected to their neighborhoods and to the larger city.

The setting of this paper is Dammam, Saudi Arabia. This city is chosen because it is a typical Saudi city. It is also the capital of the Eastern region. It originally consisted of several hamlets that relied on fishing and pearls for their survival. It has now developed into a thriving hub of industries, commerce, and science. In this city, the roads have changed dramatically, and the city has expanded fast. The boundary of the city that is used in this study is the original boundary before the government extended it (in black, figure 1). Three healthcare facilities within the city are also selected for closer analysis. These are Bader healthcare center, King Fahad Specialist Hospital and Badee healthcare center. They are marked as A, B and C in Figure 1.



Figure1: The land use map of Dammam. Red indicates commercial areas, yellow represents residential areas, blue indicates public services such as medical facilities and universities etc., purple represents industrial and storage areas, and green indicates open spaces, green areas, and leisure. Source: (the Eastern Province Municipality, <https://webgis.eamana.gov.sa/gis/#/maps>)

King Fahad Specialist Hospital (KFSH) is a large complex, and an important hospital in the Eastern region of Saudi Arabia. It was started to serve as a tertiary referral hospital providing specialized medical care to the population of the Eastern Region. Figure 2 shows the campus, including all the streets inside it and the exterior roads that are adjacent to it. The exterior roads are included because they connect to the entrances of the campus, and that some parking are located outside the boundary walls in the west. However, visitors to the main hospital can enter from many entrances. Most of the entrances are close to the main streets inside the campus, such as the main entrance of the hospital, (in axis 1 of figure 2). The outpatient department entrance, the emergency department entrance, and Cath lab entrance are in axis 2, figure 2. Also, the employees have a private entrance from the west side of the main building, which is almost invisible from the main streets (See figure 11)

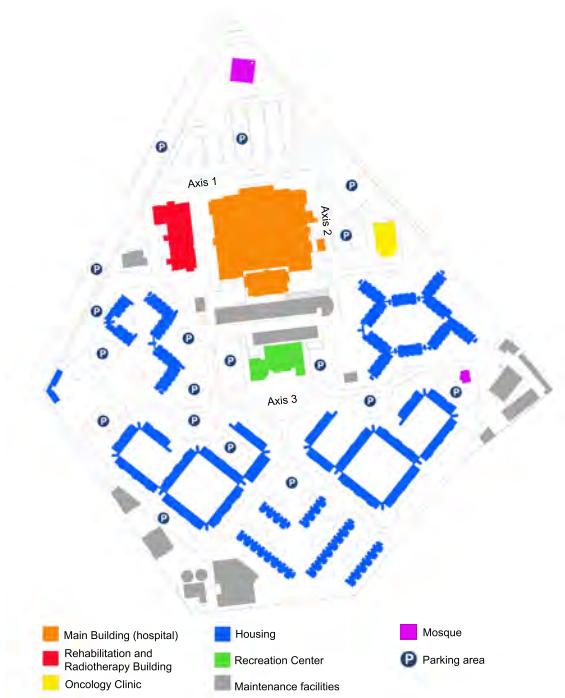

Figure 2: The buildings of KFSH Campus

The network measures used in this section have already been described in the Space Syntax section. Both integration or closeness value, and choice or betweenness value are applied in this research. These are widely used to understand many urban structure-function relationships.

For axial map analysis, typically all barriers which obstruct movement are considered and the fewest and longest lines that connect all spaces to cover all the convex spaces in the layout are drawn. For this study, the axial maps of the city of Dammam and KFSH campus were based on road central lines of the street network. The axial map of the city was created by drawing lines on a separate layer above the Google map images using AutoCAD software. In total, two base maps were produced. These included an axial map of the city including KFSH campus (Figure 3), and an axial map of the KFSH campus's roads with exterior roads (Figure 4). After the basic map models were prepared, they were saved in the drawing format (DXF) and imported to Depthmap program. This is a software used to conduct a series of spatial network analysis for understanding social interactions within the spatial environment (Turner 2011). The output is a map of the area with colors from warm to cool (reds to blues) that corresponds to the range of high to low Space Syntax values. The process is shown in figure 4.



Figure 3: Axial map of the city of Dammam

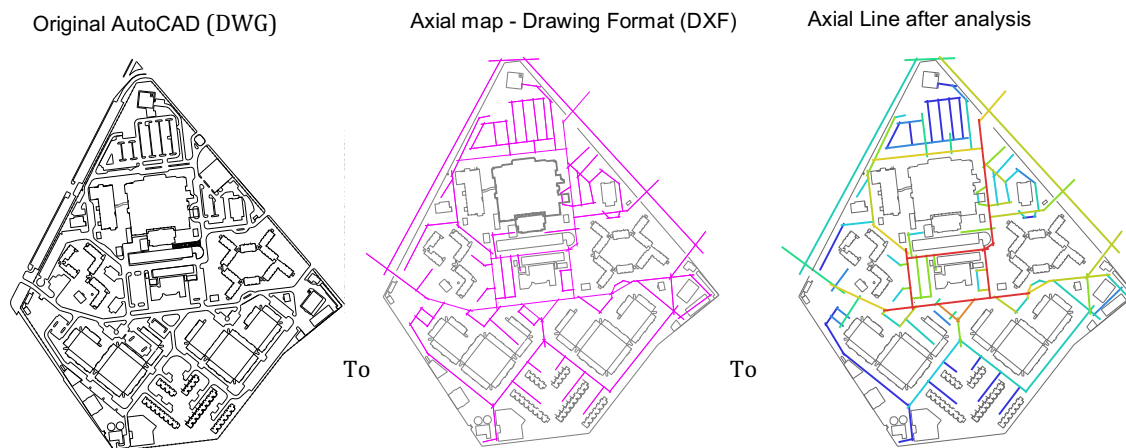

Figure 4: Process for producing data of axial map of the KFSH campus.

Space Syntax allows accessibility modelling using three measurement types: metric, topological and geometric. Metric analysis at low radii produces a diagram that shows 'patches' of neighborhood areas that are accessible at that radii. The methodology produces different accessibility values based on connection characteristics and distance considerations. Metric analysis is useful to understand areas that are more culturally biased and restrictive, and so are useful to model neighborhoods (Hillier 2010). Literature has provided ample evidence that most cities are understood globally in topo-geometric analysis, and locally in metric accessibility terms.

With Space Syntax techniques, it is possible to compute the integration values of lines at different radii. In this paper, experiments were conducted at the radii of 400m, 800m, 1600m, 2km, and infinite distance as connectivity zones to capture different urban configuration features. The integration value at radius 'n' of a line considers the total number of steps needed to cover all the lines in a given axial system.

Finally, a core map is defined as the highest ten percent of all the values of the lines in a given layout (Hillier and Hanson, 1984). This indicates the 'spread' of the high integration or high choice value lines over the city or campus and provides a clue of their relationship to the city functions. For example, literature informs us that integration cores indicate areas of functional centers and identify the streets that connect parts of cities to one another. Since these lines have higher concentration of commerce or are connectors between various parts of the city, a hint can be obtained regarding possible busy areas and high traffic roads.

4.0 FINDINGS

4.1 Comparison of Dammam with previous Space Syntax findings

Configurational investigation of cities done with Space Syntax methodology reveals a closeness 'structure' usually identified as an 'integration' pattern, and a 'betweenness' structure modelled as 'choice' (figure 5 and 6) Integration analysis of Dammam shows a cluster of red lines that identify a central area. Literature is very clear in demonstrating that more integrated areas are typically destination areas where one might expect functions of meeting and commerce (Hillier et al. 1993). The integrated area identified in Dammam corresponds with the city's center or downtown. This is a vibrant area that serves as a hub for various public activities such as markets, commercial activities, and government buildings. This area is mostly commercial and has the highest land values. Figure 5 also shows some integrated streets (in red) connecting the center to other parts of the city and to its edges. This makes the downtown easily accessible from all parts of the city. This center-to-outskirt connection helps sustain the downtown as a convenient location for entertainment, retail, and other public amenities that are easily accessible to citizens living in different parts of the city. Space Syntax analysis clearly brings out this function of the city.



Figure 5: Integration/Closeness map of Dammam, Saudi Arabia

Figure 6 is a 'betweenness or choice' model of Dammam. This variable indicates streets that lie between origins and destinations of all possible movements within the city. These roads are therefore expected to be more crowded because of cars and pedestrians passing through (See section 2.1). The choice 'core' thus identified can be considered as the major link roads of Dammam. These link roads also serve to connect various parts of the city to one another (Hillier, Yang, and Turner 2012).



Figure 6: Choice or Betweenness map of Dammam, Saudi Arabia.

In Dammam, it is additionally important to note that the radial streets identified earlier in the Integration analysis are also highlighted by the Choice analysis. Comparing figures 5 and 6, it can be said that the streets which connect the center to the edges function both as areas of commerce and as destinations, and as connection corridors for 'passing through'. A combination of integration and choice is a good representation for this phenomenon. This is shown in figure 7 that indicates clear central areas and connectors. The authors have visually verified the street functions both 'on the ground' and with land use maps obtained from municipality websites (<https://webgis.eamana.gov.sa/gis/#/maps>). From these, the authors can attest to the city of Dammam traffic patterns and land use distribution is as anticipated by Space Syntax literature and described in section 2.1.



Figure 7: Composite values (Integration times Choice) map of Dammam, Saudi Arabia

4.2. Configurational accessibility of healthcare clinics and hospitals within the city of Dammam

Configurational pattern is also a powerful indicator of accessibility. It is so because layout has a strong influence on how people move within their environments. This is both a factor of distance and geometry. Hillier et al. 2010 had claimed that city functions are globally geometric but locally metric. In other words, he suggested that human movement at local levels (such as within their neighborhoods) are influenced more by metric distances. However, movement across large areas of the city are influenced by topology or geometric variables of the street network. This argument was, of course based on cognitive considerations. Haq (2020) had used local metric analyses to identify accessible areas within neighborhoods and has demonstrated that these areas are indeed locations of local amenities such as schools and parks. From this, he supported Hillier's assertion that spatial modelling done by space syntax with both metric and topogeometric considerations correlate with actual use, but in two different scales.

Figure 8 shows the two kinds of Syntax analysis superimposed on a map of Dammam. The 'background' layer, shown as black 'patches', is the result of metric analysis done at a radius of 800 meters, approximately half a mile, which is considered a ten-minute walk. In other words, the background layer indicates all the neighborhood streets that are accessible by walking only for ten minutes. The foreground, colored layer is betweenness/choice values of the entire city. As explained earlier, they indicate areas of high movements. On these two layers the locations of healthcare facilities are mapped.



Figure 8: Two kinds of Space Syntax analysis superimposed on a map of Dammam showing 'background' layer of neighborhood centers and a colored 'foreground' layer that shows high choice streets that connect various parts of the city to one another. Locations of various healthcare facilities are also shown.

A careful examination of this image identifies some remarkable results. First, almost all the health facilities are located within the 'patches' of their neighborhoods. Since these patches were identified by running the metric analysis at 800 meters radius, it can be concluded that on an average, all healthcare facilities in Dammam are located within a ten-minute walk inside their neighborhoods. This is a powerful finding that indicates that the healthcare facilities are quite accessible to the citizens living nearby. Second, it is noted that a colored line either connects to, or comes very close to all the health facilities also. Since the colored lines indicate streets connected at a global level to other parts of the city, it can be further deduced that the health facilities are also accessible to the citizens of other parts of the city. From these two related observations, it can be concluded that health facilities in Dammam are easily accessible both from within the localities in which they serve, and other areas of Dammam. This was perhaps one intention of the Saudi health policy. On another note, the metric (background) analysis coupled with the geometric 'choice' analysis also indicates potential locations for future clinics and hospitals.

To further understand the configurational accessibility of these healthcare facilities, a sample of three were selected and their topological reach was calculated up to four changes in direction. (See figure 9). In other words, the question was from how far might a citizen travel to reach a health center if they could only made four turns? Since number of turns indicates cognitive complexity, a relatively lower number was chosen. The analysis in figure 9 indicates an interesting phenomenon. Because of local layout differences, each health center has a different 'reach'. Health center A has a long reach along a high choice street and goes into the downtown area (shown in blue). King Fahad Specialist Hospital (KFSH) in the middle, shown in green, reaches quite a bit of its neighboring areas, and spreads long main streets to other parts of the city. Health center C is perhaps the loneliest one reaching a few streets close by and spreading northwards. The question that crops up is this: why do the three facilities show different patterns? The answer is in the local street layout. While locating public buildings, it is worthwhile to think about its immediate neighborhood layout as well as its reach into other far away locations.

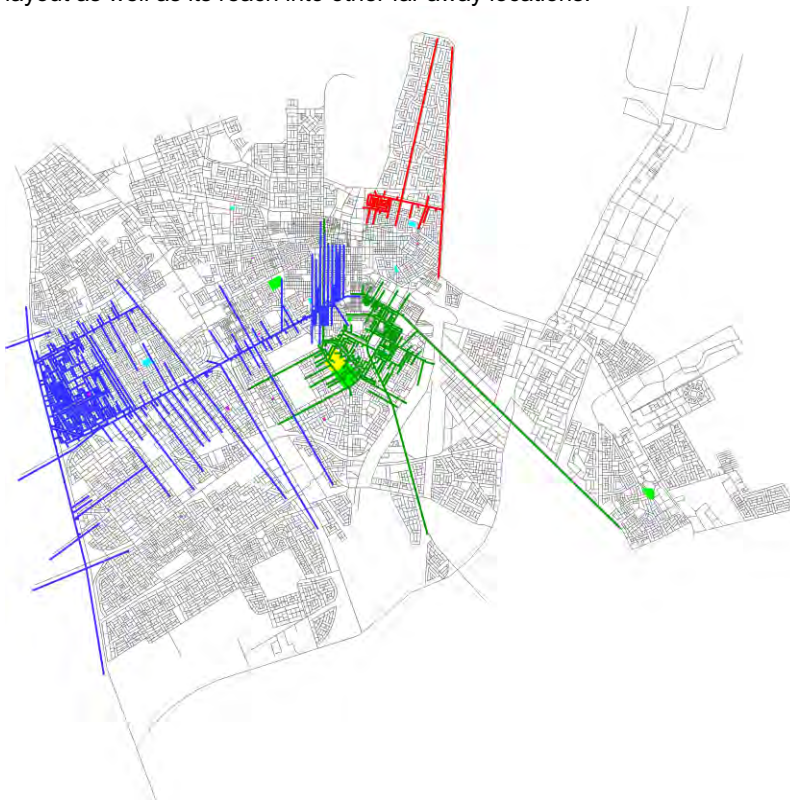

Figure 9: Reach of three healthcare facilities up to four changes of direction.

4.3. A detailed analysis of King Fahad Specialist Campus (KFSH)

At this point, this paper investigates one hospital in more detail and takes up a different system of spaces for analysis. Figure 8 shows the relationship of KFSH to the global 'choice' pattern. The hospital is adjacent to more than one road that has high choice values. As described earlier, choice/betweenness values calculated at a global (n) level indicate streets that are expected to be busy because they have higher possibilities of traffic 'passing-through'. This is the case also in Dammam. Since the high choice value of roads indicate betweenness value of roads, it can be said that the KFSH campus are accessible to most of the citizens in distant parts of the city. In comparison, the green areas in Figure 9 indicate the adjacent areas that will be considered 'close' by the citizens. For them the hospital will be accessible with only four changes in direction.

So, when citizens access KFMH, what might their accessibility experience be inside the campus? Figure 10 shows the integration or closeness analysis of the campus vehicular system. Since most of the site entrances are in the western side, and a 'crossroad' is located south of the main building, the Syntax structure tends to favor the eastern part of the main building seen by the red or orange lines. Figure 11 shows all the buildings of this campus and identifies all their entrances. Here a discrepancy is observed. While some entrances are directly off the integrated areas, there are some buildings and some entrances of the main buildings that are not. Since 'natural movement' (Hillier et. al., 1993) favors integrated areas, this discrepancy indicates a potential wayfinding issue (Haq, 2003)



Figure 10: The axial line analysis of vehicular system of the campus; showing the integration value at radius 'n'



Figure 11: The syntactic analysis of vehicular system of the KFSH campus showing the integration core at radius 'n' (10% of all the axes)

5.0 DISCUSSION AND CONCLUSION

This paper is an exploratory study about the accessibility of health complexes within the city of Dammam. Accessibility refers to a configurational property that considers the layout of all spaces in the city, which in turn creates possibilities for movement. It includes the complex relationship between the spatial separation of the population and the locational aspects as understood by a layout's connection network. This unique condition of accessibility is modelled by using computerized techniques of Space Syntax. The theory is based on rigorous social concepts and developed over time by numerous empirical studies that have noted positive relationships between its accessibility measures and various behavioral and cognitive variables across continents.

The work described is done at three levels: the city and its relationship to the medical buildings, topological accessibility modelling of these facilities to understand the cognitive aspects, and integration/closeness study inside King Fahad Specialist Hospital. While the investigations were carried out using appropriate Space Syntax analysis, the conclusions

were drawn with reference to findings that have been previously reported in the literature and visual survey of the existing conditions.

Since the Saudi Government has commissioned many clinics and hospitals in different cities to provide free health care with equal access to all citizens, this paper investigated the locational characteristics of all medical facilities in Dammam, Saudi Arabia. Most of the medical facilities are indeed connected to the neighborhoods at a ten-minute walking distance and are also part of the global system of the city, so that they connect at both local and global levels. Thus, access is easy both for the neighborhood residents and for those who wish to come from afar. In essence, this study has highlighted an often overlooked aspect of public health, which is the value of configurational accessibility with respect to the population spread. It has also demonstrated the modelling technique for investigating such configurational accessibility and decision making regarding locating healthcare facilities in large cities.

REFERENCES

- AlAmoudi S. 2017. *Health empowerment and health rights*. Saudi Arabia: Saudi medical journal
- AlKahtani, M. 1991. *The spatial pattern of health facilities*. Saudi Arabia: Development and planning Geo Journal
- Almalki, M., Fitzgerald, G., and Clark, M. 2011. *Health care system in Saudi Arabia: an overview*. Eastern Mediterranean health journal.
- AlYousuf, M., Akerele, M., Al-Mazrou, Y. 2002. *Organization of the Saudi health system*. Eastern Mediterranean Health Journal
- Black, M., Ebener, S., Aguilar, N., Vidaurre, M., and El Morjani, Z. 2004. *Using GIS to measure physical accessibility to health care*. In ESRI 2004 international health conference proceedings.
- Gallagher, EB., 2002. *Modernization and health reform in Saudi Arabia*, In: Twaddle AC, ed. Health care reform around the world. London: Auburn House.
- Guagliardo, F., 2004. *Spatial accessibility of primary care: concepts, methods and challenges*. International Journal of Health Geographics
- Haq, S., and Luo, Y. 2012. *Space Syntax in Healthcare Facilities Research: A Review*. HERD: Health Environments Research & Design Journal.
- Haq, S. and Zimring, C. 2003. *Just down the road a piece*. The development of topological knowledge of building layouts. Environment and Behavior Journal
- Haq, S. 2003. *Investigating the syntax line: configurational properties and cognitive correlates*. Environment and Planning B: Planning and Design. London: Pion Publications.
- Haq, S., & Berhie, G. 2018. *Space syntax investigation of Lubbock, a grid-like American city and some insights into isotropic layouts*. Journal of Urban Design.
- Haq, S. 2020. *Grid geometry and core structure: Space Syntax analysis of small and medium 'grid-like' US Cities*. EAAE-ARCC International Conference & 2nd VIBRArch: The Architect and the City, Valencia, Spain.
- Hillier, B., Yang, T., and Turner, A. 2012. *Normalising least angle choice in depthmap and how it opens up new perspectives on the global and local analysis of city space*. The Journal of Space Syntax
- Hillier, B., Penn, A., Hanson, J., Grajewski, T., Xu, J. 1993. *Natural movement: or, configuration and attraction in urban pedestrian movement*. Environ. Plan. B: Plan. Des. 20, 29–66.
- Hillier, B. 1996. *Space is the machine*. Cambridge University Press.
- Hillier, B. and Hanson, J. 1984. *The Social Logic of Space*. Cambridge: Cambridge University Press.
- Hillier, B., A. Turner, et al. 2007. *Metric and topo-geometric properties of urban street networks: some convergences, divergences and new results*. Proceedings of the Sixth International Space Syntax Symposium, Istanbul, I.T.U.
- Hillier, B. 2005. *The art of place and the science of space*. World Architecture. Beijing,
- Hillier, B. and Iida, S. 2005. *Network and psychological effects in urban movement*, Proceedings of Spatial Information Theory: International Conference. Heidelberg: Springer-Verlag Berlin.
- Hillier, B., Burdett, R., Peponis, J. and Penn, A. 1987. *Creating life: Or, does architecture determine anything?* Architecture and Behavior/ Architecture et Comportment.
- Hillier, B., Turner, A., Yang, T. and Park, H. 2010. *Metric and topo-geometric properties of urban street networks: some convergences, divergences and new results*. The Journal of Space Syntax.
- Kubat, A. S., Ince Guney, Y. and Ozer, O. 2014. *Historic City Centers Under Threat: The Case of Sharjah, UAE*. In Journal of Faculty of Architecture ITU
- Lu, Y. and Bozovic-Stamenovic, R. 2009. *Cultural perspective of wayfinding behavior: exploring the socio-spatial variable in three Chinese hospitals case studies*. International Journal of Architectural Research.
- Ministry of Health. *Patient's Bill of Rights and Responsibilities*. Riyadh: Ministry of Health; [Accessed date 2020]. Available from URL: <http://www.moh.gov.sa/en/HealthAwareness/EducationalContent/>
- Mubarak, A. 2004. *Urban growth boundary policy and residential suburbanization*: Riyadh, Saudi Arabia, Habitat Int'l
- Penn, A., Hillier, B., Banister, D., and Xu, J. 1998. *Configurational Modelling of Urban Movement Networks*. Environment and Planning B: Planning and Design Journal.
- Penn, A. and Dalton, N. 1994. *The architecture of society: Stochastic simulation of urban movement, Simulating Societies: The Computer Simulation of Social Phenomena*. London: UCL Press.
- Peponis, J., Hadjinikolaou, E., Livieratos, C., and Fatouros, D. A. 1989. *The spatial core of urban culture*. Ekistics
- Rashid, M., and Bindajam, A. 2015. *Space, movement and heritage planning of the historic cities in Islamic societies: Learning from the Old City of Jeddah, Saudi Arabia*. URBAN DESIGN International
- Setola, N., and Borgianni, S. 2016. *Designing public spaces in hospitals*. ProQuest eBook Central.
- Shengelia, B., Murray, L., and Adams, B. 2003. *Beyond Access and Utilization: Defining and Measuring Health System Coverage*. Switzerland: World Health Organization.
- Turner, A. 2011. *Products, UCL Depthmap*, available at: <http://www.spacesyntax.net/software/>

Miami Solarium (1928) to the Sun Ray Health Resort: From a Hotel-Sanatorium to Hotel-Health-Resort-Spa

Vandana Baweja¹, Sonny J. Russano¹

¹University of Florida, Gainesville, FL

ABSTRACT: This paper charts the history of the Miami Solarium with respect to changing health discourses and the shifting contours of Miami tourism. The intertwined histories of the sanatoria as spaces of leisure and health tourism are evident in the vicissitudes of the history of the Miami Solarium.

KEYWORDS: Heliotherapy, Tourism, Miami

INTRODUCTION

In 2019, numerous United States cities, counties, and states obtained hotel accommodations to isolate their homeless population who needed to be quarantined due to COVID. (Fuchs 2021) Indeed hotels all over the world were used to quarantine people and, in many places, also to provide therapeutic facilities for mild COVID19 cases. Typically, a hotel and a hospital are viewed as distinct building types – one for tourism, and the other for health care. Prior to COVID19, just about a century ago, the lines between the hotel and the hospital for tuberculosis treatment were quite blurred. This paper examines the relationship between heliotherapy for the treatment of tuberculosis in the early twentieth century and the establishment of the Miami Solarium (1928) as a hospital, sanatorium, and resort, as a moment in history that represents the high point in fusion of the two pillars of Florida tourism – health tourism and elite winter travel – into one building type for sun tourism. The intertwined histories of the sanatoria as spaces of leisure and health tourism are evident in the vicissitudes of the history of the Miami Solarium.

1.0 TUBERCULOSIS

1.1 White Plague

In the early twentieth century, the leading causes of mortality in the United States were: pneumonia, influenza, tuberculosis (all forms), diarrhea (with enteritis), and ulceration of the intestines. (Department of Commerce and Labor and Bureau of the Census 1906) Tuberculosis, known as the white plague, was broadly categorized into pulmonary tuberculosis (also known as consumption, or phthisis), or tuberculosis of the lungs; and non-pulmonary tuberculosis, which was known as surgical tuberculosis. (Gauvain 1912) By the mid-nineteenth century, the medical community shared observations on the prevalence of tuberculosis in dense urban areas, poorly ventilated buildings with high occupancy rates, and humid sites. Physicians attributed “vitiating air,” which was air that had reduced oxygen content and was expired because it was inhaled too many times by people, as one of the chief causes of tuberculosis. Thus, the medical community viewed pulmonary tuberculosis as an “indoor disease,” the cure for which was pure outdoor air. (Abbott 1898) The open-air sanatorium method of treatment of pulmonary tuberculosis was established in the third quarter of the nineteenth century with the pioneering work of Dr. George Bodington (1799– 882) in UK; Dr. Hermann Brehmer (1826–1889), who established a sanatorium in 1854 Görbersdorf, Silesia now in Poland; and Peter Dettweiler (1837–1904), a former patient of Dr. Brehmer, who established a sanatorium at Falkenstein in Germany in 1876 (Cyriax 1925; Warren 2006) In the United States, Joseph Gleitsmann established the first sanatorium in 1875 in Ashville, North Carolina, which was followed by Edward Livingston Trudeau’s Adirondack Cottage Sanatorium at Saranac Lake in 1886. (Murray, Hopewell, and Schraufnagel 2015)

1.2. Germ Theory

Even though Robert Koch in 1882 identified the bacterium *Mycobacterium tuberculosis* as the causal agent in the transmission of tuberculosis, the cure for the disease continued to be through the sanatorium method. The germ theory gave even more boost to the hypothesis that crowded urban indoor living with poor ventilation led to the spread of airborne infections such as tuberculosis, whooping-cough, and influenza. (Abbott 1898; Burt 1890) After Robert Koch established the bacterial etiology of tuberculosis in 1882, Arthur Downes and Thomas Blunt in 1877 first discovered and reported the bactericidal properties of the ultraviolet (actinic) component of sunlight. (Downes and Blunt 1878)

1.3. Heliotherapy

In Euro-American health discourses, the medical opinion that exposure to sunlight was therapeutic and healthy, began gaining traction as the bacteriological etiology of diseases was established. (Freund 2012) Consequently, the practice

of treating contagious and chronic diseases with exposure to sunlight, known as heliotherapy, became popular. The Nobel Laureate Dr. Niels Finsen (1860–1904), established the practice of using sunlight clinically as a bactericidal agent and established modern clinical phototherapy for the treatment of tubercular infections of the skin (lupus vulgaris). (McDonagh 2001) There were two main forms of light therapy – the outdoor exposure to natural sunlight known as heliotherapy and indoor treatments, such as phototherapy, artificial sunlight therapy, ray therapy, and actinotherapy. (Woloshyn 2017) The two most influential practitioners of heliotherapy in the early twentieth century were – Dr. Oskar Bernhard (1861–1939) and Dr. Auguste Rollier (1874–1954). Bernhard practiced heliotherapy for surgical wounds as the surgeon-in-chief at the District Hospital at Samaden in Switzerland. (Hobday 1997) Rollier began to deploy heliotherapeutic methods in 1903 for treating tuberculosis at his clinic at Leysin in Switzerland. (Hobday 1997) While Bernhard used heliotherapy locally, irradiating the specific infected or injured part of the body to the sun, Rollier exposed the entire body of the patient to sunlight through sun baths as a treatment for non-pulmonary tuberculosis, that is “surgical” tuberculosis. (Hobday 1997) Rollier proposed that the exposure to sunlight resulted in the body’s absorption of solar radiation, which boosted the metabolism and energized the body in its fight against the tubercular infection. (Rollier 1922) During and after the First World War, heliotherapy gained currency as a treatment for torpid wounds, fistulas, gangrene, frost bite, trench foot, and chemical exposure to gases. (Hinsdale 1919) French physicians sent their war injured for heliotherapeutic treatments to marine locations such as Vichy, Aix-les-Bains, Berck, and Cannes. (Hinsdale 1919) By 1906, physicians recognized four broad treatments for tuberculosis: open air treatment, high-altitude treatment (mountain cure), heliotherapy (sun treatment), and thalassotherapy (seacoast treatment). (Freudenthal 1906) Rollier’s heliotherapy methods included both exposure to the sun and air, with the primary focus on sun exposure through sun baths in sun porches. (Rollier 1927) Although sanatoria and heliotherapeutic clinics looked similar, the sanatoria were focused on features such as multiple terraced balconies to maximize exposure to air, while solaria (sun terraces) were the prime feature of the heliotherapeutic clinics – with the caveat that sunlight was not entirely absent as a remedial agent in sanatoria, where it was deployed for its germicidal properties to curb the spread of tuberculosis. (Hobday 1997)

1.4. Solarium

The solarium, also known as a sun porch or sun parlor is a space for bodily exposure to the sun for leisure and/or therapeutic purposes. The architectural definition of the solarium in the 1840s published in *A Glossary of Terms Used in Grecian, Roman, Italian, and Gothic Architecture* was:

...literally a floor, but used for a garret; the space under the roof, and above the upper ceiling. The roof-loft was sometimes so called. The name of *Solarium*; was also applied to the terraces on the tops of the houses of the ancients. (Parker 1840, 201)

By the end of the nineteenth century, the Solarium was widely understood as a terrace for sun exposure. In an 1876 publication – *An Encyclopædia of Architecture, Historical, Theoretical, and Practical* – the solarium was defined as a terrace, which was used when the weather permitted. (Gwilt and Papworth 1876) The solarium was not confined to houses, but also occurred in religious buildings – for example the upper terrace known as the solarium in the byzantine Basilica of the Apostles was decorated with bronze railings. (“Medieval Architecture in France-No. 2” 1840)

In the early twentieth century, the solarium gained popularity with the rise of heliotherapy. Dr. Oskar Bernhard, advocated for solaria that minimized wind or draught exposure, and maximized insolation, that is the amount of solar radiation that a given building area received. (Bernhard 1921) Bernhard founded a clinic in 1899 in St. Moritz, an alpine town in Switzerland, where he constructed terraced recuperative spaces called *Liegehallen*, on sloping mountain sides to maximize insolation. Rollier began his work with two building types that were modified to serve as heliotherapeutic clinics: a mountain chalet repurposed into a sanatorium in 1903 in Leysin, Switzerland; and *Les Chamois*, an existing alpine hotel that was adapted into a sanatorium. (Rollier 1921) In the Leysin chalet, Rollier added wide balconies on the south side of the chalet and an open solarium the second floor for sun cure. (Rollier 1921) Rollier converted *Les Chamois*, into a clinic with the addition of solaria on each floor of the south-west elevation of the hotel. (Rollier 1921) Rollier incorporated solaria into all heliotherapeutic buildings that he built. (Hobday 1997)

By 1902, solaria were being added to American hospitals as well. The Deaconess Hospital in Longwood in Boston, designed by Kendall, Taylor & Stevens, in 1902 was built with a solarium. (Brown 1902) By the end of the First World War, solaria were a standard feature of modern British and American hospitals. In the solarium at Derbyshire Sanatorium in Chesterfield, the physician Dr. Fowler designed a combined space for natural and artificial heliotherapy, which was a wooden structure with a linoleum covered concrete floor. (“Hospitals and Sanatoriums” 1920) The octagonal glass enclosure on a flat roof top was designed to capture the sun from all directions during all times of the day. (See figure 1)

2.0 MIAMI

2.1. Florida as a Health Destination

In the 1830s, Dr. Andrew Anderson, a well-known Boston physician who moved to St. Augustine, promoted the city as a destination for consumptives. (Revels 2011) In addition to St. Augustine, several spas developed around Floridian freshwater springs, which were established in the antebellum period, but acquired their status as a therapeutic destination after the civil war. (Revels 2011)

HOSPITALS AND SANATORIUMS.

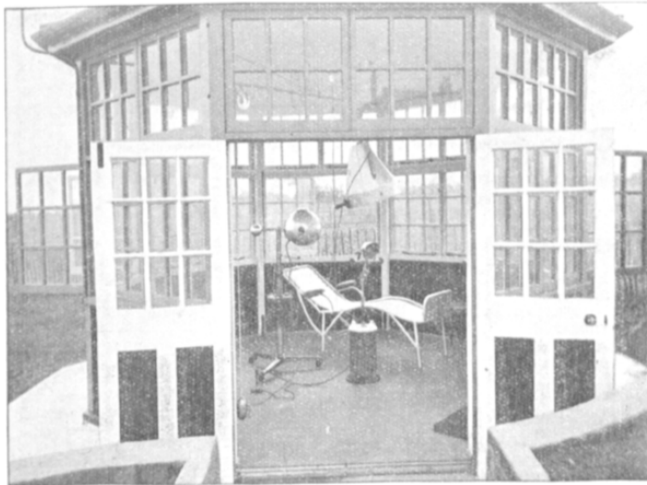

Solarium, Derbyshire Sanatorium, Chesterfield.

Figure 1: Solarium, Derbyshire Sanatorium. Source: "Hospitals and Sanatoriums." 1920. *Tubercle* 1 (9): 449–50.

These spas, which drew their clients mostly from the plantation belt, included – White Sulphur Springs community (1843) on the upper Suwannee River for rheumatism; Suwannee Springs, also known as Lower Suwannee Springs (1845) to the west of White Sulphur Springs on the Suwannee River for invalids; Orange Springs (1843) on the Oklawaha River for consumptives; Newport Springs (1844), on the St. Marks River for invalids; and the nationally famous Green Cove Springs (1830) on the St. Johns River. (Vanderhill 1973) After the civil war new resorts were established which included – Hampton Springs (1870s) built around a long-used Sulphur spring in the pine flatwoods; Worthington Springs (1890s) on the Santa Fe River; Safety Harbor (1890s) on the western shore of Old Tampa Bay; and Panacea (1890s) located south of Tallahassee on Apalachee Bay. (Vanderhill 1973) These spas contributed to the healthful image of Florida's climate and as a destination to heal with nature. In addition, these spas also foreshadowed the intertwined histories of leisure and health tourism in Florida. As the tourism infrastructure improved, Florida became a therapeutic destination for several ailments after the civil war. In the early twentieth century, Miami known as the "Magic City," emerged as America's tropical playground. With its balmy climate and sunshine, Miami was consistently promoted as a tourist destination for health and leisure.

2.2. Heliotherapy in Miami

In 1914, an introductory article about heliotherapy published in *Miami Herald*, introduced readers to the sun cure:

It isn't the name of a patent medicine or a breakfast food or a new dance. It's just medical Greek for plain everyday "sun cure." To practice it you simply peel off as many clothes as law and custom permit or even more if your own house or yard offers proper protection and you bask in the sun steadily and persistently until you have as fine a coat of tan or bronze or Indian copper or beet red as your skin is capable of. Then you keep right on basking. (*The Miami Herald* 1914,4)

In 1904, in Florida, an experimental tuberculosis camp was started at the Pensacola Navy Yard, which comprised tents for patients. (Walters 1905) Till 1923, Florida had no state sanatorium for tuberculosis. There were two public hospitals – the Tuberculosis Pavilion in the Jacksonville Duval County Hospital, and the Tampa Hillsboro County Sanatorium. (National Tuberculosis Association. 1923) By mid-twenties, physicians began promoting Florida's abundant sunshine for heliotherapy. In 1927, Dr. E. Starr Judd of Rochester, Minnesota, professor of surgery at the Mayo clinic, claimed that "Florida today stands an excellent chance of becoming the Mecca for health-seekers from all over the world." (*Miami Tribune* 1927) On May 11, 1928, in a note reproduced from the *St. Petersburg Independent* in *The Miami News* titled *Sunshine Is An Age-Old Medicine*, urged that the Sunshine City St. Petersburg should be the first city to establish a heliotherapy center. Thus, till 1928, there was no major heliotherapy facility in Florida.

2.3. Sanatoria Types

By 1905, the types of sanatoria in operation were: the chalet type, the cottage type, the hotel type, and the hospital. (Walters 1905) Since sanatoria began as transformations of Alpine chalets, cottages, and hotels into sanatoria; it is no surprise that this new building type would continue to embody features of its original buildings. As chalets and cottages were repurposed into sanatoria, these types of sanatoria had separate buildings for patients and administrative rooms. (Walters 1905) The hospital type sanatorium had patient rooms and administrative rooms in one building. The "Hotel-Sanatorium," emerged as a building type with the rise of the open-air treatment method and heliotherapy for tuberculosis. (Walters 1905) This kind of hotel-sanatorium originated in the Alpine hotels of Switzerland. (Walters 1905) The Galen Hall on Atlantic City established in the late nineteenth century by Dr. W. H. H. Bull was one of the most popular hotel-sanatoria on the east coast. (*The Philadelphia Times* 1896) (See figure 2)

Miami Solarium (1928) to the Sun Ray Health Resort: From a Hotel-Sanatorium to Hotel-Health-Resort-Spa



Figure 2: Galen Hall, Atlantic City, New Jersey. Source: Foster & Reynolds Co. 1910. *The Standard Guide, Florida*. St. Augustine, Florida: Foster & Reynolds, 24C

2.4. Miami Solarium

Miami's prime heliotherapeutic facility called the Miami Solarium opened both as a hotel and a sanatorium, where the boundary between therapeutic and leisure tourism was quite blurred. The Miami Solarium was described as a "well-appointed resort hotel, with treatment for illness as an additional feature." (*The Miami News* 1929, Second News Section, 7) The intertwined histories of the sanatoria as spaces of leisure and health tourism are evident in the vicissitudes of the history of the Miami Solarium. In 1928, A. W. Ellis, founded the corporation Miami Solarium Inc., which was the parent company of the Solarium. (*The Miami News* 1928) The chief medical advisor to the facility was the retired Rear Admiral Charles F. Stokes, who was the surgeon general of United States from 1903 to 1906 during President Theodore Roosevelt's term. (*The Miami Herald* 1929) On December 16, 1928, an advertisement in the *Miami Herald* announced the opening of The Miami Solarium on 120 S.W. 30th Avenue Miami, Florida. (*The Miami News* 1928) The Miami Solarium was founded as a facility for, "those suffering from arthritis, hypertension, cardiorenal diseases, lowered metabolism and other chronic conditions." (*The Miami News* 1928) The facility offered heliotherapy, physiotherapy, hydrotherapy, and dietetics, with the bonus that families could accompany patients. The advertisement claimed that "The cost of spending the winter at this modern sunshine sanitarium, including daily medical supervision and treatment, living suite, meals, auto trips and recreational facilities, is extremely reasonable." (*The Miami News* 1928) For patients and their guests, the Miami Solarium provided recreational facilities such as a miniature golf course and outdoor sports that included tennis and croquet courts. The Miami Solarium was founded as a "modern American plan hotel and sanitarium catering to a refined class of guests either as residents or as day patients." (*The Miami Herald* 1930, 26) The Miami Solarium complex comprised three main buildings and an ensemble of smaller structures, with two air terraces or solaria. (*The Miami News* 1931) The main wing of the building was entered through an arcade that connected the administrative and the medical buildings, with two detached housing structures. (*The Miami News* 1931) The medical building comprised forty rooms, of which about twenty were designated as special treatment rooms, while the remaining twenty were used for administrative purposes. (*The Miami News* 1931) The solaria or sun terraces for heliotherapy were located on the roof of the medical building, which were enclosed in Cello glass walls and covered with Vita Glass roofs to maximize the exposure to ultra-violet rays and ensure a steady temperature. (*The Miami News* 1929) These solaria were used to provide heliotherapeutic treatments for arthritis, nephritis, high blood pressure, anemia, bronchitis, asthma, paralysis, lowered metabolism, deafness, and other chronic ailments. (*The Miami News* 1929)



Figure 3: The Miami Solarium (after it became the Sun Ray Health Resort)

Romer, Gleason Waite. 1947. *Street View of Sun-Ray Park Health Resort and Grounds*. Black-and-white negative. Gleason Waite Romer Photographs. Helen Muir Florida Collection. Special Collections and Archives. Miami-Dade Public Library System.



Figure 4: Source: Interior View of the Arcade that connected the administrative and the medical buildings with the housing buildings.

Romer, Gleason Waite. 1948. *Interior View of Lobby at Sun-Ray Park Health Resort*. Black-and-white negative. Gleason Waite Romer Photographs. Helen Muir Florida Collection. Special Collections and Archives. Miami-Dade Public Library System.

In 1931, the Miami Solarium Inc. defaulted on its principal and interest against bonds worth \$60,000, which were issued on May 1, 1930, at an interest rate of 7 per cent. (*The Miami Herald* 1931). On September 21, 1931, Mr. H. H. Taylor, on behalf of City Trust Company, filed a lawsuit against Miami Solarium Inc., to sue the company on account of default of principal and interest payments and the fact that the Solarium building needed repairs. (*The Miami Herald* 1931). Emerging from this financial crisis, in 1932, the Miami Solarium was relaunched as the Sun Ray Sanatorium, and the president of the Miami Solarium Inc. A. W. Ellis became the president of a new corporation in partnership with Allen R. Howard of Westwood, Boston. (*The Miami Herald* 1932)

Miami Solarium (1928) to the Sun Ray Health Resort: From a Hotel-Sanatorium to Hotel-Health-Resort-Spa



Figure 5: Beauty Salon Treatment at Sun-Ray Park Health

Romer, Gleason Waite. 1951. *Beauty Salon Treatment at Sun-Ray Park Health Resort*. Black-and-white negative. Gleason Waite Romer Photographs. Helen Muir Florida Collection. Special Collections and Archives. Miami-Dade Public Library System.



Figure 6: Patient inside Turkish Bath and Steam Room

Romer, Gleason Waite. 1933. *Patient inside Turkish Bath and Steam Room at Sun-Ray Park Health Resort*. Black-and-white negative. Gleason Waite Romer Photographs. Helen Muir Florida Collection. Special Collections and Archives. Miami-Dade Public Library System.

By 1943, the sanatorium was more akin to a wellness spa cum retirement home with a menu that included baths, massages, nude sunbathing, beauty treatments, and an exercise pool with Sulphur water. (*The Miami Herald* 1943) (See Figure 5) The health treatments were optional and for those who wanted to use the facility as a hotel only did not have to pay for them. (*The Miami Herald* 1943) Although the medical practice of heliotherapy was abandoned by the end of 1940s, in the popular imagination the prophylactic and therapeutic properties of sunshine persisted as a phenomenon that scholars term as *heliosis*. (Carter 2012) Owing to *heliosis*, the Sun Ray Sanatorium continued as a hotel-health resort-spa. It closed in 1970. (Page 1970)

CONCLUSION

The trajectory of Miami Solarium is a lens through which one can view the intertwined histories of leisure and health tourism. The Miami Solarium's numerous incarnations offer a glimpse into the changing relationships between climate and health.

REFERENCES

- Abbott, Samuel W. 1898. "Consumption: An Indoor Disease." *The Boston Medical and Surgical Journal* 138 (1): 1–4.
- Brown, R. 1902. "Notes from Boston: USA." *The British Architect* 58 (November): 381.
- Bernhard, O. 1921. "The Climatic and Sunlight Treatment of Surgical Tuberculosis." *Tubercle* 2 (11): 490–97.
- Burt, Stephen Smith. 1890. "Pulmonary Consumption in the Light of Modern Research." *Pacific Record of Medicine and Surgery* 5 (4): 100–103.
- Campbell, Margaret. 2005. "What Tuberculosis Did for Modernism: The Influence of a Curative Environment on Modernist Design and Architecture." *Medical History* 49 (4): 463–88.
- Carter, Simon. 2012. "The Medicalization of Sunlight in the Early Twentieth Century." *Journal of Historical Sociology* 25 (1): 83–105.
- Cyriax, Richard J. 1925. "George Bodington: The Pioneer of the Sanatorium Treatment of Pulmonary Tuberculosis." *British Journal of Tuberculosis* 19 (1): 1–16.
- Department of Commerce and Labor, and Bureau of the Census. 1906. "Mortality Statistics, 1900 to 1904." Washington, DC: US Department of Commerce and Labor.
- Downes, Arthur, and Thomas P. Blunt. 1878. "III. Researches on the Effect of Light Upon Bacteria and Other Organisms." *Proceedings of the Royal Society of London* 26 (December): 488–500.
- Freund, Daniel. 2012. *American Sunshine: Diseases of Darkness and the Quest for Natural Light*. Chicago; London: University of Chicago Press.
- Freudenthal, Wolff. 1906. "The Climatic Treatment of Tuberculosis of the Upper Air Tract." *The Laryngoscope* 16 (10): 790–96.
- Fuchs, Jonathan D, Carter, Henry Clay, Evans, Jennifer, Graham-Squire, Dave, Imbert, Elizabeth, Bloome, Jessica, Fann, Charles, Skotnes, Tobi, Sears, Jonathan, Pfeifer-Rosenblum, Rebecca, Moughamian, Alice, Eveland, Joanna, Reed, Amber, Borne, Deborah, Lee, Michele, Rosenthal, Molly, Jain, Vivek, Bobba, Naveena, Kushel, Margot, Kanzaria, Hemal K., 2021. "Assessment of a Hotel-Based Covid-19 Isolation and Quarantine Strategy for Persons Experiencing Homelessness." *JAMA Network Open* 4 (3): e210490.
- Gauvain, H.J. 1912. "Surgical Tuberculosis: Its Needs and Treatment." *The Lancet* 180 (4641): 356–60.
- George, Paul S. 1981. "Passage to the New Eden: Tourism in Miami from Flagler through Everest G. Sewell." *The Florida Historical Quarterly* 59 (4): 440–63.
- Hinsdale, Guy. 1919. "The Sun, Health and Heliotherapy." *The Scientific Monthly* 9 (3): 253–62.
- Hobday, R.A. 1997. "Sunlight Therapy and Solar Architecture." *Medical History* 41 (4): 455–72.
- "Hospitals and Sanatoriums." 1920. *Tubercle* 1 (9): 449–50.
- McDonagh, Antony F. 2001. "Phototherapy: From Ancient Egypt to the New Millennium." *Journal of Perinatology* 21: S7–12.
- Miami Tribune*. 1927. "Florida Is Seen Mecca for Health," March 4, 1927.
- "Medieval Architecture in France-No. 2." 1840. *The Civil Engineer and Architect's Journal* 3 (July): 220.
- Murray, J.F., P.C. Hopewell, and D.E. Schraufnagel. 2015. "Treatment of Tuberculosis: A Historical Perspective." *Annals of the American Thoracic Society* 12 (12): 1749–59.
- National Tuberculosis Association. 1923. *A Tuberculosis Directory: 1923*. New York: National Tuberculosis Association.
- Gwilt, Joseph, and Wyatt Angelicus Van Sandaw Papworth. 1876. *An Encyclopædia of Architecture, Historical, Theoretical, and Practical*. London: Longmans, Green, and Co.
- Hobday, R.A. 1997. "Sunlight Therapy and Solar Architecture." *Medical History* 41 (4): 455–72.
- Page, Clinton. 1924. "Miami Building News." *Miami Herald*, May 25, 1924.
- Page, Al. 1970. "Nursing Home Occupancy Drops." *The Miami Herald*, April 16, 1970, sec. D.
- Parker, John Henry. 1840. *A Glossary of Terms Used in Grecian, Roman, Italian, and Gothic Architecture*. Oxford: J.H. Parker.
- Revels, Tracy. 2011. *Sunshine Paradise: A History of Florida Tourism*. Gainesville, Florida: University of Florida Press.
- Rollier, A. 1921. "The Construction of an Institution for the Heliotherapeutic Treatment of Surgical Tuberculosis." *Tubercle* 2 (6): 241–50.

- Rollier, A. 1927. "Heliotherapy: Its Therapeutic, Prophylactic and Social Value." *The American Journal of Nursing* 27 (10): 815–23.
- Roussel, P. 1929. "The First International Light Conference and Professor Rollier's Jubilee." *British Journal of Tuberculosis* 23 (1): 21–26.
- Schmidt, Richard E. 1918. "The Advance Hospital Planning Equipment During the Last Thirty Years." *The Architectural Review* 24 (4 Hospital Number): 61–80.
- The Miami Herald*. 1914. "Heliotherapy," July 6, 1914.
- The Miami Herald*. 1929. "Solarium Official Has a Notable Career," December 29, 1929.
- The Miami Herald*. 1931. "Suit Asks Receiver for Miami Solarium," September 22, 1931.
- The Miami Herald*. 1932. "New Firm Takes Sanitarium Here," June 19, 1932.
- The Miami Herald*. 1943. "Florida's First Approved Health Resort Has Grown," February 1, 1943.
- The Miami News*. 1929. "Miami Solarium Starts Second Season in Area," December 22, 1929, sec. Second News Section, 7.
- The Miami News*. 1931. "Miami Solarium Opens for New Season Today," December 27, 1931.
- The Miami News*. 1943. "Sun-Ray Sanitarium, Hotel Has Colorful History," November 15, 1943.
- The Philadelphia Times*. 1896. "Spring Days by the Seaside," April 19, 1896, Sunday edition.
- Vanderhill, Burke G. 1973. "The Historic Spas of Florida." *Geographic Perspectives on Southern Development* 12: 59–77.
- Walters, F. Rufenacht. 1905. *Sanatoria for Consumptives: A Critical and Detailed Description Together with an Exposition of the Open-Air or Hygienic Treatment of Phthisis*. London, New York: S. Sonnenschein & Co.; E. P. Dutton & Co.
- Warren, Peter. 2006. "The Evolution of the Sanatorium: The First Half-Century, 1854–1904." *Canadian Bulletin of Medical History (Bulletin Canadien d'histoire de La Medecine)* 23 (2): 457–76.
- Woloshyn, Tania Anne. 2017. *Soaking up the Rays: Light Therapy and Visual Culture in Britain, C. 1890–1940*. Manchester: Manchester University Press.

Data Dissonance: An Exploration of Community Knowledge of Extreme Temperature Vulnerabilities

Nina Spellman¹, Michelle Laboy¹

¹Northeastern University, Boston, MA

ABSTRACT: Extreme temperature events are the deadliest type of natural disaster in the United States, and climate change has only enhanced their impact. While there is a growing body of knowledge on characteristics of the built environment and sociodemographic attributes contributing to population-scale vulnerability, there is comparatively less local knowledge about choices and priorities that inform individual outcomes in extreme temperature events. Existing resilience indicators like the Social Vulnerability Index are useful for identifying the geographic distribution of high vulnerability groups but translating statistical risk into actionable policies and interventions requires a more complete grasp of community understandings of and response to extreme temperatures. Situated within the context of a larger research project examining community vulnerability to extreme temperatures, this study is based in Worcester, MA, a post-industrial city with complex intersections of physical and social vulnerabilities. Through community-based participatory research, the team worked in partnership with a local non-profit organization to design and carry out a community workshop in the summer of 2021. This paper focuses on a single activity from the workshop in which participants engaged in a community concept drawing exercise to explore the ideas of “vulnerability,” “resilience,” and “community.” Through coding of the resulting drawings, the research identifies patterns in how participants think about extreme temperature vulnerability and provides insights into the methodological use of community concept drawings. Further experiments will be necessary to generalize findings, but the results of this case study have identified areas of dissonance between academic and community understandings of resilience and highlight some of the flaws embedded in traditional approaches to vulnerability assessments. Ultimately this work is a first step in building a grounded theory around the relationship between quantitative data and community knowledge of extreme temperature events.

KEYWORDS: Community resilience, social vulnerability, extreme temperatures, community concept drawing

1.0 BACKGROUND

As climate change progresses, extreme temperature events are increasing in both frequency and lethality. Extreme heat continues to be the deadliest weather-related hazard in the United States (NOAA 2021), with an anticipated 200k deaths in 12 US cities by 2100 (Nahlik et al. 2017). Events such as the February 2021 winter storm in Texas illustrate that extreme cold is also a significant threat, displacing thousands of residents (Armenakis and Nirupama 2014) to overcrowded ad hoc warming centers (Govertsen and Kane 2021) and leading to over 200 fatalities (Texas Department of State Health Services 2021). Research shows that during power outages typical homes can reach dangerous temperatures within a few hours (Urban Green Council 2014), leaving even those with air conditioning or other backup mechanical advantages in a precarious situation.

The passive survivability of a housing unit can dictate health outcomes during extreme temperature events. Studies have demonstrated that factors like sun exposure, envelope conditions, and insulation have a substantial impact on the interior temperature of a home (Samuelson et al 2020a). Unfortunately, large-scale data sets on the built environment are rare and - when they exist - often inadequate. For example, the tax assessment records used by many studies to identify features such as construction age and building type are often inaccurate and fail to capture nuances like the presence of window unit air conditioners (Samuelson et al 2020b). Improvements in data collection and building modeling will eventually provide a more granular and accurate picture of the risks posed by the built environment, but equally important are the characteristics of those who inhabit the buildings studied and the social support systems of their communities.

The literature suggests that sociodemographic attributes are significant determinants of vulnerability to extreme temperatures and other stressors. The US Center for Disease Control and Prevention (CDC), for example, publishes the Social Vulnerability Index, which identifies demographic characteristics that may exacerbate negative effects—human suffering and economic loss—in the face of external natural or human-caused stresses on human health, defining communities that may “need support before, during, or after disasters” (Flanagan 2018). Other efforts to create nation-wide heat vulnerability maps have highlighted the impact of demographic, health, and environmental factors while acknowledging the influence of social connectivity and the need to reproduce these maps at a smaller scale by incorporating local data (Reid et al 2009). Studies based on U.S. Census variables and other national data sets provide insight into population-scale vulnerabilities but offer comparatively less local knowledge about choices and priorities that inform individual outcomes in extreme temperature events.

Groups that are already disadvantaged - whether by being low-income, and thus potentially more likely to be living in poorly insulated houses, or by having disabilities or being elderly and having less mobility - can be expected to face increased challenges during climate disasters. However, an individual's sociodemographic features alone do not determine resilience. Analyses of data that include measures such as social cohesion and networks have revealed the importance of social capital in lower mortality, and that physical factors of disasters that affect mortality are more likely to involve the intensity of the hazard rather than the characteristics of the protective infrastructure (Aldrich and Sawada 2015). Community-level social capital, i.e., resources embedded in civil networks including existing and new non-profit organizations, has been found to be especially important in post-disaster recovery when controlling for other demographic and geographic factors; and in some cases this impacts rehabilitation, redesign or rebuilding efforts for physical infrastructure and housing (Aldrich 2011).

Because climate change has a disproportionate impact on specific populations, the community is an important unit for analyzing vulnerability and resilience. In disaster resilience literature, community resilience is described as a collective, as opposed to individual, ability; measured in terms of how neighborhoods or geographically defined areas "deal with stressors and efficiently resume the rhythms of daily life through cooperation following shocks" (Aldrich 2012). This capacity for resilience can determine whether a natural hazard becomes a natural disaster (Henly-Shepard 2013). Generating knowledge about and increasing the resilience of communities prior to extreme temperature - or other climate - events requires participation of the communities themselves if it is to inform effective policies, resource allocation and implementation of resilience-building strategies.

2.0 RESEARCH PROBLEMS AND GOALS

There is a growing body of knowledge on how features of the built environment relate to extreme temperature resilience, but there are few examinations of the dynamic between those physical or technical features and the people who interact with them. Researchers have established the importance of incorporating housing stock characteristics into resiliency tools like city-wide Heat Vulnerability Indices (Samuelson et al 2020) but fail to address the ways in which knowledge and behaviors at a community level might ameliorate or exacerbate high-risk physical conditions. Resilience is ultimately about people adapting to changing situations. In situations of more frequent or intense built environment failures due to environmental or manmade hazards, socio-ecological resilience emerges from the interaction between physical and social infrastructure--in other words, the ability of people to manage, retrofit, adapt physical infrastructure, and in many cases overcome its limits through community action (Laboy and Fannon 2016).

Ownership and management of the built environment is widely dispersed, making it difficult both to collect data and to execute policies. A failure to acknowledge this fact means that the practice of mapping housing characteristics has only limited practical value. This limitation can be seen as a symptom of the dissonance between the top-down approach of academia and urban planning practices and the realities of implementing resilience measures at scale. Developing and realizing effective community resilience strategies involves improving an existing urban fabric that architects and engineers have historically neither designed nor studied (Fannon and Laboy 2019). In the case of extreme heat, housing is more than a protective infrastructure: it can be the determinant of environmental conditions, and thus the physical characteristics of housing can create different hazards for different people. Therefore, understanding not only local physical conditions, but also people's awareness of housing and community characteristics that make them vulnerable, and their motivation and ability to recognize these differences in risk may be critical to designing appropriate community responses.

The outcomes of extreme temperature events are dictated by a complex interplay of contextual elements, one of which is the relationship between demographic vulnerability factors as defined by spatial analysis and those factors that are considered most important by community members based on their lived experiences and knowledge of place. This study seeks to expand an understanding of how people think about vulnerability and provide insight into any differences between what researchers have discovered to be statistically significant factors of vulnerability and what community members consider to be most important.

3.0 METHODS

3.1. Research context

This research examines the potential dissonance between community and researcher-identified vulnerability and resilience factors through a case study in Worcester, Massachusetts. This post-industrial city possesses a complex intersection of physical and social vulnerabilities and is the site of a larger study to which the data examined in this paper will contribute important insights. That larger research project combines highly technical housing stock analysis and modeling using smart thermostat data, with qualitative, community based participatory research (CBPR) - which is the context in which this paper is focused. More specifically, civil engineers on the team are producing a multi-variable regression analysis to predict the interior conditions of housing units based on tax assessment data and exterior temperatures. In contrast, CBPR is an approach in which the subjects are equal partners in the research enterprise, shaping the direction and methods of research so that the output is of value to the community as well as to the research team. This paper is narrowly focused on the results of one research activity led during one of the community workshops

conducted in the summer of 2021. Eventually, this qualitative data will become part of a more comprehensive analysis of an ongoing series of CBPR-based methods that will be evaluated in dialogue with the quantitative analyses. When findings from both methods are synthesized with a nuanced assessment of physical conditions and human behaviors, the larger project has the potential to generate a clarified and more holistic understanding of community vulnerability and resilience to extreme temperatures.

3.2. Research setting

This case study is centered in Worcester for reasons of methodological suitability, data availability, and logistical convenience for a Boston-based research team. As both the second largest city in New England and one of Massachusetts' officially designated "gateway cities," Worcester is a valuable study site to assess the intersections of physical and social vulnerability in an urban environment. Unlike many other post-industrial cities, Worcester has experienced slow but continuous population growth since the 1980s, largely due to an influx of foreign immigrants. It has significant concentrations of statistically vulnerable populations: there are higher rates of poverty, people with limited-English proficiency, minorities, and people with disabilities than in the rest of Massachusetts (CHA Steering Committee 2018). Compounding these factors are a distinct set of built environment challenges. In 2008, Worcester experienced an infestation of Asian Longhorn Beetles that necessitated the removal of over 30,000 trees (Palmer 2014). This substantial loss of street trees has made the city more sensitive to extreme heat and its population more aware of the impact of tree canopy on urban heat. A 2019 citizen science project produced a map of the heat island effect in Worcester, highlighting the dramatic difference in air temperatures across different parts of the urban area (McCauley 2019). Worcester has an older housing stock - 48% of homes were built in 1939 or earlier - and lower rates of owner occupancy than the rest of the state (CHA Steering Committee 2018). Importantly, Worcester is also home to a dedicated network of community-based organizations and a population receptive to efforts to address the city's vulnerabilities, two factors that have facilitated community partnerships essential to the success of this participatory research.

3.3. CBPR and community concept drawings

The team began by conducting a quantitative evaluation of Worcester. Data obtained at municipal and statewide levels were used to generate a set of maps identifying the highest-vulnerability areas of the city. Focused on the variables that previous researchers have identified as most important to extreme temperature vulnerability, these maps are a traditional, academic representation of knowledge. These abstracted visualizations offer a baseline understanding of the researchers' perspective on socioeconomic vulnerability; local context is necessary to transform the maps into a meaningful tool. The two primary assumptions of this work are that community knowledge is 1) just as important as academically produced knowledge and 2) impossible to replicate through purely quantitative means.

Using a model of community-based participatory research, the research team worked in partnership with a local non-profit organization to design a workshop that uncovers community understandings of and responses to extreme temperatures. For the workshop activity analyzed in this paper, the team partnered with the Regional Environmental Council (REC) YouthGrow program, an "agriculture-focused youth development and employment" program offering summer job opportunities to local high school students (Regional Environmental Council). REC was an invaluable addition to the research team: they provided local insights, the time and effort of a group of YouthGrow collaborators, a site to hold the workshop and assistance in recruiting community members for the event.

A wide net was cast for recruitment, with multiple community-based organizations posting materials - as approved by the Institutional Review Board - on their social media platforms while the YouthGROW collaborators leveraged their personal networks. The workshop was held in July of 2021 at one of REC's urban farms. It was two hours long and involved a series of activities and discussions that were first piloted and redesigned earlier in the month by one of the principal investigators in collaboration with the YouthGrow partners. While a summer downpour created some unexpected logistical challenges, the workshop was successfully carried out with the aid of seven YouthGrow collaborators, their two team leaders, and a five-person research team from Northeastern University. There were a total of sixteen participants, and efforts were made to create mixed groups of people who did not previously know each other. Throughout the workshop, YouthGrow collaborators at each table helped facilitate smaller group discussions while the research team led the sequence of activities, made observations, and provided additional support where needed.

While future studies will assess the workshop activities holistically and in combination with data gathered during subsequent workshop events, this paper focuses on a single type of activity from the July 2021 experiment: community concept drawings. This "participatory visual method" is intended to produce a "deep understanding of how local communities make sense of complex concepts" (McOmber et al. 2021, 1) and was used in tandem with several other activities to explore the concepts of community, vulnerability, and resilience. The strategy was adapted from a method developed by McOmber et al. to guide groups of individuals through the process of defining concepts in a manner that is grounded by common community understandings and expressed in visual, verbal, and textual forms. The procedure described in their paper involves an intensive 2-hour collaborative drawing session. Due to time and resource constraints, the process was simplified and shortened for the workshop into a series of brief exercises intertwined with

other activities but retained the structure of the original method. Brainstorming on the meaning of the concepts - community and vulnerability - was followed by more considerate elaboration of those initial ideas. The group then reflected on the concepts through a ranking process and resolved their thoughts through a discussion of the actions required to transform from one concept to another – in this case, from vulnerable to resilient. In this paper the drawings have been analyzed as a first step in the research, but in isolation from the discussions and other workshop activities.

3.4. Workshop structure

The following list describes the full sequence of activities carried out during the workshop. The design of and output from steps 3, 4 and 7 are the focus of the analysis in this paper.

1. Project and participant introductions
 - a. Everyone describes the hottest day that they have experienced.
2. Heat transfer exercise
 - a. Using physical models, the researchers set up a demonstration to test how different insulation materials (Styrofoam, foam, Thermoply) impact the heat retention of a glass box with a lightbulb inside of it.
 - b. Participants predict which box will get the hottest over a 20-minute period.
3. Community drawing
 - a. Participants are given a pen and a blank sheet of paper and are asked to depict the most important parts of their community using any combination of words, drawings, and symbols.
4. Vulnerability concept drawing
 - a. Each table group has a brainstorming session on what vulnerability means in the context of extreme temperatures.
 - b. Everyone is given a sheet of 8.5x11" paper in landscape orientation with a double-sided arrow along the bottom of the page. One end is labeled "most vulnerable" and the other "least vulnerable."
 - c. Participants are asked to arrange elements from their community drawing along the spectrum of vulnerability, adding additional elements as they see fit.
5. Reflection
 - a. Each table group collectively decides on the top five most important factors of vulnerability to extreme temperatures.
6. Heat transfer review
 - a. Researchers reveal results of the heat transfer exercise. Participants share what was most surprising along with any lessons or questions.
 - b. The group discusses the science behind the different insulation options and the connections between the exercise and the interior conditions of homes during extreme temperature events.
7. Resilience annotations
 - a. Using a different-colored pen from the vulnerability drawing, everyone annotates their vulnerability concept drawing with notes and drawings that address how resiliency might be increased for the most vulnerable elements of the community.
8. Vulnerability and knowledge gaps discussion
 - a. A workshop-wide discussion is held on what individuals and the community at large need to know about increasing resilience and what questions further research might help answer.

4.0 FINDINGS

During steps 3, 4, and 7 participants provided a rich mixture of visual and textual data by engaging in community concept drawing exercises that explore the ideas of "community," "vulnerability" and "resilience." Transcripts from the table discussions will be coded and analysed at a later stage of this research, and those findings will be compared with and analysed in relation to the findings from the analysis of drawings. Words and images from the drawings have been collected, coded based on a series of thematic relationships, and analysed. The qualitative nature of this approach demands emergent methods of analysis that will continue to evolve throughout the study. While the findings of this experiment are not entirely expected, they do provide useful insights into both the subjects of community resilience and extreme temperatures and to community concept drawing as a research method.

5.0 DISCUSSION

5.1. Consistency: defining vulnerability and community

Participants are consistent in their approach to describing the concepts of vulnerability, resilience, and community. While there is variation in the character of the drawings and the amount of background knowledge individuals demonstrate about extreme temperatures, there is substantial overlap in their conceptual approach to defining community and in the specific factors mentioned

Most participant drawings identify some, but not all, of the same sociodemographic variables highlighted in the literature reviews as sources of increased vulnerability. Most commonly cited are factors related to income, health, and age. Non-English speakers and access to transportation are not mentioned. A slim majority (7/13) of those who completed the vulnerability drawing include "homeless people" in their depiction of the most vulnerable parts of their community.

Homelessness goes beyond low-income status to include a lack of permanent shelter, indicating a focus not on individuals who are specifically vulnerable to extreme temperatures but those who are the most vulnerable across all situations. Only three participants reference the built environment in their “highest vulnerability” categories, and even these are focused on neighbourhood-scale features (e.g. “people that live in heat islands” and “folks who live in commercial places”). Outside of these individuals demonstrating subject-specific knowledge about the impact of urban features on temperature, participants focus on identifying different categories of people that they perceive as particularly vulnerable. This is an important indicator that while the participants are broadly conscious of the risks associated with certain sociodemographic categories, there is less awareness of - or at least concern with - the impact of one’s immediate built environment on health outcomes in extreme temperature events.

Another shared feature of the drawings is in how participants define their communities: as a combination of social and physical elements (see Figure 1). The physical features are primarily institutions and public spaces (e.g., “school,” “hospital,” “park”). Nearly half of the participants (6/15) drew clusters of houses that can be assumed to reference homes and/or neighbourhoods, but with one exception these are not labelled with place names. The terms used are almost all unspecific, describing concepts of community rather than features of each individual’s particular community. The specific activities and locations mentioned vary per individual - one might include “biking” while another mentions “cooking” - but only a single participant did not reference at least one physical and one social element in their drawing. The results of this exercise do not provide a concrete answer for how people define the boundaries of their community but indicate that participants do not consider their immediate neighbourhood representative of their community, nor do they base ideas of community solely on their own interpersonal connections. Running additional trials of this experiment may clarify the nature of these community definitions, but existing evidence undermines the value of both map-based and sociodemographic approaches because the definitions are neither strictly geographic nor strictly social.

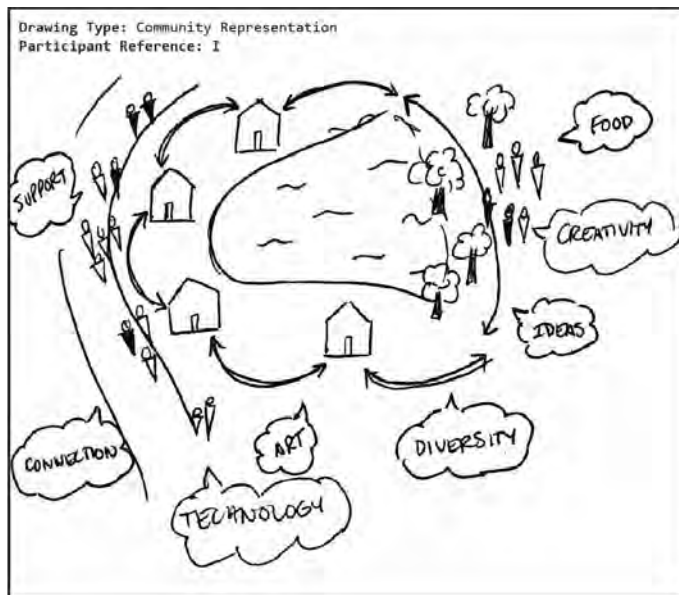

Figure 1: Example drawing from the workshop in which the anonymized participant includes both physical and social elements.

5.2. Scale: crafting solutions

Based on this study, the most substantial difference between academic and community understandings of extreme temperature vulnerability lies in the scale of proposed solutions. While architecture literature emphasizes a technical approach - improved insulation, more efficient energy systems, etc. - that occurs at the scale of a housing unit or building, most of the participants’ ideas for increasing resilience would at a minimum require organizational interventions, and many would demand substantial public policy changes (see Figure 2). Participants primarily want improved and/or free access to specific resources like food and healthcare which would theoretically address the individual’s personal factors of vulnerability. Other suggestions include altering the physical environment in ways that require municipal-scale action (e.g. creating community cooling centers, planting more trees, building better roadways). The only explicitly community-scale resiliency efforts mentioned are those that relate to improving or creating community connections: four drawings included references to community-building events or practices of community support. In all the resilience notes and drawings, only two individuals addressed the importance of the immediate built environment by mentioning housing insulation. Notably, the resilience drawings were completed after a live demonstration and explanation of the impact of insulation on heat retention; even after being primed to consider insulation as a factor, most participants did not mention it or other housing-related issues in their drawings. While academics and other professionals are aware of how individuals’ immediate physical environment and social connections can dictate health outcomes in extreme weather events, high-level discussions about and representations of resiliency among community members were mostly focused on large-scale solutions.

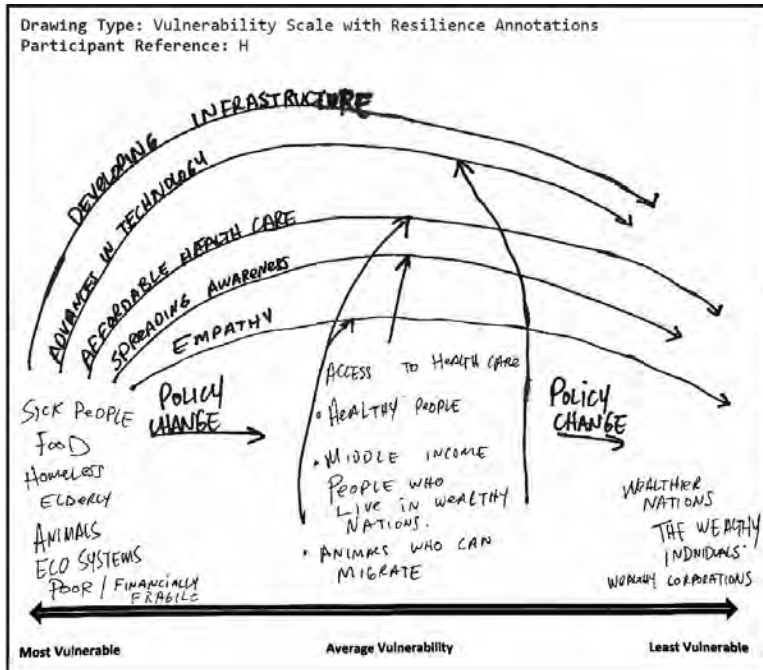

Figure 2: Example drawing from the workshop in which the anonymized participant focuses on policy-scale resiliency measures

5.3. Connections: independence versus interdependence

Throughout the descriptions of both vulnerability and paths to resilience, there is a tension between a desire to increase the independence of individuals and to create or improve systems of aid and community reliance.

The goal of fostering independence is expressed in part through participants' focus on addressing the root of social vulnerabilities (e.g. by increasing incomes) in a way that empowers people to protect themselves and become less dependent on others for assistance. Two participants mention the differences between multi and single-family homes, seeing the latter as less vulnerable and highlighting home ownership as a step towards resilience. In both examples there is an implied association with the ability to control one's own environment, to achieve financial independence and not be subject to the whims of individuals - such as landlords - who are more empowered to instigate changes. These notions of independence and the emphasis on alleviating certain underlying vulnerabilities is contrasted with a diverse array of notions that relate to sharing and connection.

The community drawings reveal that people define communities through a series of common resources and places in addition to experiences of diversity and connectivity. These ideas of existing or aspirational communities also include ideas of sharing the world with an ecosystem (animals, plants) that is also itself vulnerable. Solutions must include these elements as both a service to people - providing emotional support or a cooling effect - but also as something with an inherent right to exist and be protected. Most (10/14) of the resilience notes discuss shared resources (e.g., community fridges) and some even cited community connection itself as a beneficial attribute, illustrating that decreasing vulnerability is not a strictly economic exercise and that participants are interested in solutions that expand social networks in addition to producing better infrastructure and municipal support systems.

5.4. Abstraction: assessing the methodology

In the research team's first use of "community concept drawing" (a methodology that was defined only in 2021), the strategy effectively leads participants to distill opinions and beliefs - which are typically grounded in personal experiences - into abstract, high-level ideas. Conversations between participants overheard during the workshop indicated that many had very specific memories of extreme temperature events and individualized ways of defining their communities, but participants took a similar approach to the task of producing community concept drawings, using mostly symbolic depictions and generic terminology. Throughout all of the drawings, only three specific place names are mentioned. With only a single exception, there is also no acknowledgement of the individual within the community drawings or in defining the problems of and solutions to extreme temperature vulnerability. The contrast between verbal discussions and the content of the drawings will make for a particularly interesting point of comparison once analysis of the workshop transcripts begins. It is worth noting that the prompt itself was intentionally vague, asking people to draw their community in terms of people, places, things, and ideas. The researchers did not want to establish a particular (e.g., geographic) definition of community through the question but instead sought to understand how the participants conceptualized the term; it may be useful for future workshops to include a subsequent question that encourages a more concrete answer (e.g., "draw your neighborhood") as a basis for comparison. In the meantime, this

workshop provides evidence that these community concept drawings could be a useful tool not just for research, but when applied to resiliency efforts. By using them to help define their ideas of community, vulnerability, and resilience, participants appear encouraged to remove themselves from a perspective centered entirely in personal experience. The act of drawing is inherently one of abstraction, allowing people to produce individualized but unspecific definitions that can then be used as a starting point for brainstorming sessions and other activities related to the production of community action plans.

6.0 CONCLUSION

The set of community concept drawings produced through this workshop exercise highlight a key difference between the perspectives of a team of researchers with backgrounds in architecture and engineering and the perspectives of individual community members. While participants do emphasize some of the same sociodemographic variables as climate vulnerability literature, most do not cite their immediate surroundings as a particularly important determinant of health outcomes. Despite a few references to issues like the urban heat island effect and limited tree cover, concerns as expressed in the vulnerability drawings are primarily directed towards large-scale social issues. The nature of these issues is mixed between those that relate to individual fortitude and those that indicate a desire for greater connection or sharing, revealing that both contribute to participants' sense of security. The community drawings demonstrate that the participants still ground their concepts of community in spaces and institutions but are either unaware of or less concerned with the risks an individual's home can pose in extreme temperature situations. Repeating this workshop with different groups of people - for example, a virtual workshop held in September 2021 was with individuals who have previously participated in a weatherization program - will provide greater insight into the circumstances under which people consider their own homes to be factors of vulnerability and resilience and how this relates to community-scale behaviors.

Moving forward, the research team will continue to conduct additional experiments and to synthesize the different forms of data collected during each workshop. Coding the transcripts from the July 2021 workshop will be particularly helpful for identifying differences between how individuals describe the concepts in their drawings and how they are articulated in group discussions, which will be developed as the subject of a longer future publication. Another remaining methodological question is whether the specific instruction telling participants to "draw" their ideas rather than writing them down had a substantial impact on the output. Most participants rely on words and phrases more than any symbology, but it is possible that framing the exercise as a drawing is what encourages people to express themselves in simplified, abstract language; further research is necessary to examine this result.

Several workshop participants displayed advanced knowledge of extreme temperature issues by using terms like "urban heat island," leading the researchers to suspect that the variation in whether people consider the built environment as a primary risk factor may depend on the individual's level of direct exposure to and relevant education on the subject. Demographic analyses of these and future participants may provide further insights into this matter as well as into any statistical differences in how different types of people define their communities. For example, it seems possible that elderly individuals - who have lived in the same place for a long time and might be less inclined towards virtual interactions - are more likely to use place-based definitions of community. Further research will also need to address the problem of how to constrain discussions of resiliency efforts to those that can occur on a localized scale; while improvements to community resilience can be facilitated by state or municipal institutions, success depends on the strong commitment and involvement of local organizations and social networks rather than on major policy changes.

The long-term aim of this research project is to provide a model for integrating qualitative social data with highly technical building data to produce a localized understanding of extreme temperature vulnerability. This paper assesses only a single component of that effort, but in addition to raising new questions for exploration it has revealed a potential community knowledge gap in whether people view their homes as risk factors and has confirmed the value of community concept drawing as a method of data collection.

ACKNOWLEDGEMENTS

This paper is part of a larger ongoing project in collaboration with Professor Michael Kane, Professor David Fannon and doctoral student Kris Govertsen, from Civil and Environmental Engineering at Northeastern University. This part of the research would not have been possible without the contribution and support of many others: The authors would like to thank all community partners at Worcester Regional Environmental Council, including the director of programs Grace Silwoski, and in particular the YouthGrow program coordinator Stacey Brimmage for championing our collaboration. The group of youth in the program, and their two leaders, provided valuable feedback on the activities and helped our team before and during the event. Special thanks to doctoral students Emma Casavant and Maharshi Pathak for helping with the workshop setup and for performing data collection during the light box simulations. This work was done with funding by Northeastern University Tier 1 Seed Grant, from the Office of the Provost, with support from the College of Arts Media and Design, and the College of Engineering. This work was conducted under the review and approval of the Institutional Review Board #21-03-29.

REFERENCES

- Aldrich, Daniel P., *Building Resilience: Social Capital in Post-Disaster Recovery* (Chicago, United States: University of Chicago Press, 2012), <http://ebookcentral.proquest.com/lib/northeastern-ebooks/detail.action?docID=988057>.
- Aldrich, Daniel P., "The Power of People: Social Capital's Role in Recovery from the 1995 Kobe Earthquake," *Natural Hazards* 56, no. 3 (March 1, 2011): 595–611, <https://doi.org/10.1007/s11069-010-9577-7>.
- Aldrich, Daniel P. and Yasuyuki Sawada, "The Physical and Social Determinants of Mortality in the 3.11 Tsunami," *Social Science & Medicine* 124 (January 2015): 66–75, <https://doi.org/10.1016/j.socscimed.2014.11.025>.
- Armenakis, Costas and N. Nirupama, "Urban Impacts of Ice Storms: Toronto December 2013," *Natural Hazards* 74, no. 2 (November 2014): 1291–98, <https://doi.org/10.1007/s11069-014-1211-7>.
- CHA Steering Committee. *Greater Worcester Community Health Assessment*. Worcester, Massachusetts: Central MA Regional Public Health Alliance, 2018.
- Fannon, David and Michelle Laboy, "Resilient Homes Online Design Aide: Connecting Research and Practice for Socially Resilient Communities," in *Intersections: Design and Resilience* (2018 AIA/ACSA Intersections: Design and Resilience, New York, NY: ACSA Press, 2019), 6–11, <https://doi.org/10.35483/ACSA.AIA.Inter.18.2>.
- Flanagan, Barry E. et al., "Measuring Community Vulnerability to Natural and Anthropogenic Hazards: The Centers for Disease Control and Prevention's Social Vulnerability Index," *Journal of Environmental Health* 80, no. 10 (2018): 34–36.
- Govertsen, Krissy and Michael Kane, "VIEWPOINT: Passive Design Improves Infrastructure and Community Resiliency during Extreme Weather," accessed August 26, 2021, <https://www.enr.com/blogs/8-new-england-news-and-views/post/46597-viewpoint-passive-design-improves-infrastructure-and-community-resiliency-during-extreme-weather?v=preview>.
- Henly-Shepard, Sarah E. 2013. "Climate Change and Disaster Vulnerability: Community-Based Socio-Ecological Resilience Research and Planning in Hawai'i."
- Laboy, Michelle and David Fannon, "Resilience Theory and Praxis: A Critical Framework for Architecture," *Enquiry: The ARCC Journal of Architectural Research* 13, no. 1 (2016): 39–53.
- McCauley, Stephen. "Resilience Worcester." THE GLOBAL LAB. Worcester Polytechnic Institute, 2019. Accessed September 14, 2021. <https://global-lab.wpi.edu/resilience-worcester/>.
- McOmber, Chesney, Katharine McNamara, and Sarah L. McKune. "Community Concept Drawing: A Participatory Visual Method for Incorporating Local Knowledge into Conceptualization." *Field Methods*, 2021, 1–18. <https://doi.org/https://doi.org/10.1177/1525822X211014736>.
- Nahlik, Matthew J., et al., "Building Thermal Performance, Extreme Heat, and Climate Change," *Journal of Infrastructure Systems* 23, no. 3 (September 2017): 04016043, [https://doi.org/10.1061/\(ASCE\)IS.1943-555X.0000349](https://doi.org/10.1061/(ASCE)IS.1943-555X.0000349).
- NOAA US Department of Commerce, "Weather Related Fatality and Injury Statistics" (NOAA's National Weather Service), accessed August 26, 2021, <https://www.weather.gov/hazstat/>.
- Palmer, Shannon, Deborah Martin, Verna DeLauer, and John Rogan. "Vulnerability and Adaptive Capacity in Response to the Asian Longhorned Beetle Infestation in Worcester, Massachusetts." *Human Ecology* 42, no. 6 (2014): 965–77. <https://doi.org/10.1007/s10745-014-9695-z>.
- Regional Environmental Council. "YouthGROW." REC Worcester. Accessed September 14, 2021. <https://www.recworchester.org/youthgrow>.
- Samuelson, Holly W., Amir Baniassadi, and Pablo Izaga Gonzalez. "Beyond Energy Savings: Investigating the Co-Benefits of Heat Resilient Architecture." *Energy* 204 (2020): 117886. <https://doi.org/10.1016/j.energy.2020.117886>.
- Samuelson, Holly, et al. "Housing as a Critical Determinant of Heat Vulnerability and Health." *Science of The Total Environment* 720 (2020): 137296. <https://doi.org/10.1016/j.scitotenv.2020.137296>.
- Texas Department of State Health Services. "News Updates." Texas Department of State Health Services, July 13, 2021. <https://dshs.texas.gov/news/updates.shtm#wn>.
- Urban Green Council, "Baby It's Cold Outside" (New York, NY: U.S. Green Building Council, February 2014), https://www.urbangreencouncil.org/sites/default/files/2013_baby_its_cold_inside_report.pdf.

Impact of Climate Change in Houston TX: Resilient Residential Buildings and Equitable Design

Raffaella Montelli¹, Mili Kyropoulou¹

¹University of Houston, Houston, TX

ABSTRACT: Temperatures are on the rise globally. Warming trends are accompanied by an increase in the frequency and magnitude of extreme climatic events with multi-million dollars losses, from which is becoming increasingly difficult to recover, particularly for the more vulnerable communities. This paper focuses on Houston, TX, residential stock and its resiliency to climate change. At this pace, temperatures are projected to increase by at least 3.2oC by 2035 in the Houston region. Preliminary results have shown that by 2080, Houston buildings would need about 50% more energy for cooling. These projections present a rather grim prospect for the most socially and economically vulnerable communities scattered across Houston with no access to or capacity to operate the air conditioning and housing with building envelopes inadequate to maintain comfort even for the current weather conditions. This study is an attempt to assess the cumulative effect of all these factors on the Houston housing stock and develop classes of vulnerability. The goal is to determine what portion of the residential building stock is more vulnerable, what characterizes it and how its vulnerability can be addressed. This is accomplished by looking at how the age of the residential building (per regulatory framework) and typology (expressed as envelope exposure) relate to their ability to respond to climate change. The preliminary analysis using a shoebox was refined and augmented with energy simulations for a sample of typical Houston's housing types that assess annual cooling and heating loads. The results are then related to socio-economic vulnerability data. Age and typology do affect the ability of the existing building stock to respond to climate change. As such, upgrading design strategies with climate change in mind must be prioritized to make Houston resilient and achieve a more equitable risk distribution across different populations.

KEYWORDS: climate change, building resiliency, equitable risk, hot climates, residential

INTRODUCTION

Increasing temperature trends due to anthropogenic climate change are often accompanied by an increase in frequency and magnitude of heat waves and extreme climatic events. Nature Climate Change has recently published a systematic global study on the health impacts of climate change. According to this study, approximately 37% globally and 20% in the United States of all heat-exposure related deaths can be attributed directly to climate change (Vicedo-Cabrera et al. 2021). The World Health Organization reports that in addition to death, excessive heat exposure can produce a wide range of damaging physiological effects, e.g. heat exhaustion, hyperthermia, heat cramps, and worsened of chronic conditions that may lead to disabilities. It also has indirect health effects, e.g. alteration of human behaviors, increase of diseases and their transmission, poor air quality, and failure of critical social infrastructure such as energy, transport and water (WHO 2015). The United States National Institutes of Health highlights the presence of a growing body of research evidence showing a spectrum of heat-related vulnerability across pregnancy, from preterm birth to congenital defects all the way to stillbirth (Konkel, 2019).

Ensuring the health and well-being of humans under climate change implies an ability to mitigate the risks mentioned above. That can only occur if the built environment can absorb the harsher conditions. The building envelope is the physical barrier between the inside and outside of the building, and therefore critical in ensuring the effective mitigation of the temperature increases. It is typically designed to properly manage moisture, temperature, and airflow to ensure interior comfort for the occupants and appropriate indoor conditions for its intended use. It is particularly vulnerable to even minor changes in weather and climate conditions, i.e. temperature, moisture, radiation and wind which can severely alter its integrity and performance.

According to Köppen-Geiger climate classification, Houston, TX (29.76° N, 95.36° W) has a Cfa humid subtropical climate. Comparing Typical Meteorological Year 3 (TMY3) (Wilcox and Marion 2008) climate data obtained by the George Bush International Airport (USA_TX_Houston-Bush.Intercontinental.AP.722430_TMY3) against data generated from the same file with the CCWorldWeatherGen (CCWWG) tool by the University of Southampton (Jentsch et al. 2013) and the commercially available WeatherShift™ (Dickinson and Brannon 2016; Belcher, Hacker, and Powell 2005) for the median year of 2080, there is a clear trend of increasing temperatures all year round (Figure 1).

Based on the Weathershift™ generated file with Representative Concentration Pathways (RCP) 8.5 and warming percentile 50% (median) for the period 2071-2090 (median at 2080), average monthly Temperatures are projected to

increase by at least 3.2°C by 2080 in the Houston region, with a maximum increase of 4.3°C during summer. The period when temperatures exceed 28°C (82.4F) will also increase from roughly 3.5 months to roughly 5 months, based on the average monthly values. The inspection of the hourly data (Figure 2) permits a better diurnal appreciation of the implications of these changes. The increase in daytime temperature is accompanied by an increase of temperature during night times between April and October.

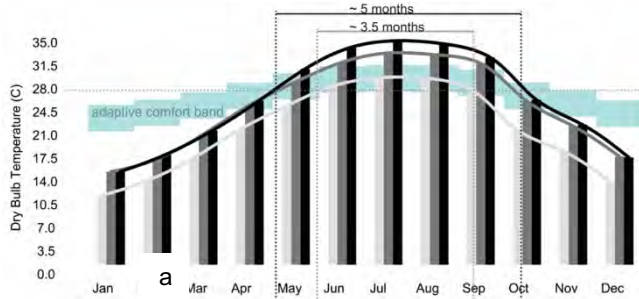

Figure 1: Changes in monthly average Temperatures in Houston, TX, from the current TMY3 file (light grey) to generated projections using WeatherShift™ (grey) and CCWWG (black) for the year 2080.

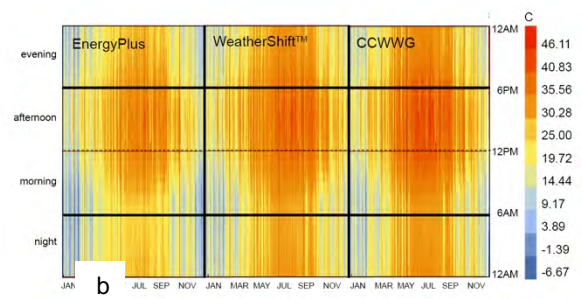

Figure 2: Hourly changes in dry bulb temperature in Houston, TX, from the current TMY3 file (left) to generated projections using WeatherShift™ (middle) and CCWWG (right) for the year 2080.

These patterns pose a greater risk in areas of urban heat island concentrations. The recently completed urban heat island mapping campaign in Houston (*Summary report 2020*; Shandas et al. 2019), (Figure 3a, Morning hours) shows an inequitable distribution of urban heat island effect across Houston with hot spots found among the most vulnerable and therefore at-risk communities (Figure 3b). The social vulnerability map is produced using the 2018 Social Vulnerability Index (SVI) created by the Centers for Disease Control and Prevention (CDC) / Agency for Toxic Substances and Disease Registry (ATSDR) / Geospatial Research, Analysis, and Services Program (GRASP) (Flanagan et al. 2018). The economic disadvantage of the most vulnerable communities means that they may not be able to afford extra energy loads or necessary upgrading to their homes to adapt to warming temperature scenarios. Climate change poses a life-threatening risk for a significant fraction of Houston population that cannot be ignored.

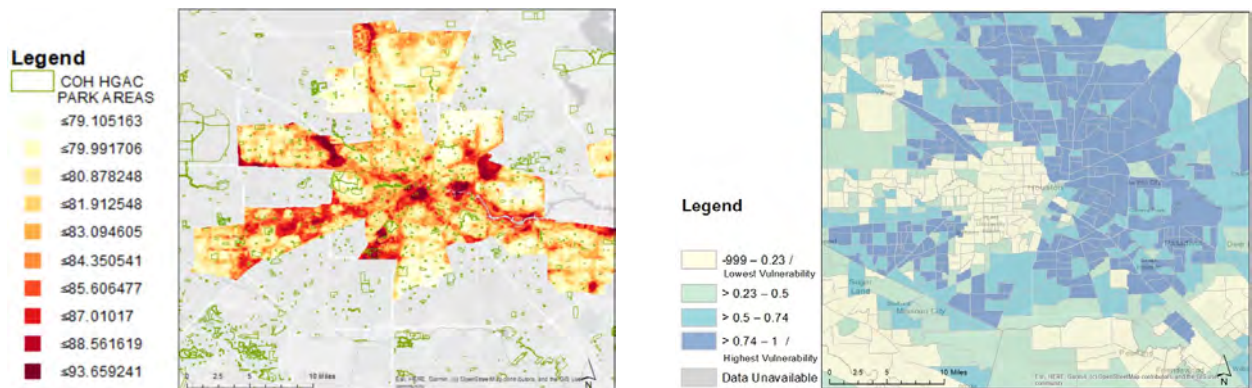

Figure 3: a: Modeled Heat Index for the morning hours across the Houston Metropolitan area shows the urban heat hot spots distribution as produced by the Heat Watch Campaign. Similar trends can be seen in the additional maps found on the Program Website (*Summary report 2020*). b: 2018 Socio-Vulnerability Index for the Houston Metropolitan Area (Maps were created using ArcGIS® ArcMap software by Esri). A correlation can be seen between heat hot spots and the most vulnerable neighborhoods.

The city has embarked on an aggressive program to reduce the urban heat island effect so that Houston is better positioned to combat the irreversible implications of climate change. In April 2020, the city of Houston launched The Houston Climate Action Plan and Resilient Houston (Houston Climate Action Plan 2020), showing a multi-pronged approach to climate change. Among other measures, it includes the adoption of light-colored roofs and pavements and of green roofs, the increase of shade trees plants and vegetation, the transition to transit-oriented and walkable communities alongside vehicle electrification, and energy efficiency building optimizations. These strategies are very encouraging, especially given that Houston population is projected to increase by about 33% by 2045 (H-GAC) and that the city is a car-dependent city with only 38% of the households in Harris county served by the public transit system (Bethel et al. 2007). In addition, the climate action plan includes a comprehensive review of building codes and standards. Houston’s current adopted code is the 2012 International Code Council (ICC), and the plan proposes adopting the 2021 ICC model codes by 2025, which includes the 2021 energy code. However, 47% of Houston’s current residential stock predates the 1960s and was designed and built with no climate change or urban heat island effect in mind. It is, therefore, of equal – if not more – importance to consider actionable strategies that will facilitate existing buildings’ energy upgrade alongside with ensuring that new construction is meeting the Paris Agreement (Paris Agreement to the United Nations Framework Convention on Climate Change Dec. 12, 2015) of carbon neutrality by 2050.

Furthermore, permit-compliant energy modelling guidelines for the design and analysis of buildings suggest using historical TMY weather data to meet building energy standard requirements such as ASHRAE (American Society of Heating, Refrigerating and Air-Conditioning Engineers) and IECC (International Energy Conservation Code). TMY weather data are synthetic data computed from several years of historical measured weather records, usually 10-20 years, occasionally combined with satellite data for solar radiation. They do not represent an actual year but rather a “typical” year of the past. They exclude extremes, and even based on the less aggressive climate change projections, they are no longer sufficiently representative of the future climate when new constructions are designed to be occupied. Efforts have been made to adopt weather data that can better account for the rapid and significant changes in weather and climate conditions. In recent years, extensive research has been done on how to include climate change in building simulations. There are various future weather data generators and methodologies, some more robust and proven than others, such as morphing. The article by Ramon et al. (Ramon et al. 2019) provides a good overview of the various existing methodologies.

This study looks at predominant residential envelope compositions as those derived from the lack of regulatory restrictions and different building envelope exposure levels resulting from typical residential typologies historically found in Houston TX, and their ability to respond to climate change scenarios. The aim is to provide a qualitative and quantitative assessment of climate change implications on residential communities by studying the existing residential building stock. The analysis accounts for both current climate conditions and projected future climatic conditions that represent climate change scenarios. In Texas, the residential sector is a more significant burden on the energy infrastructure than the commercial sector (Busby et al. 2021). This aspect, combined with the conditions and age of homes across the Houston area and the economic segregation, inequality, and increased poverty rates (Douglas 2020), called for a prioritization of the analysis of the residential building stock.

1.0 Methodology

The analysis of the residential building stock in Houston is performed with shoebox energy models (a simple box model of a building) using EnergyPlus (Crawley et al. 2000), complemented by a city-scale mapping of buildings using ArcGIS/ArcMap. Energy modelling of representative residential cases across Houston required an extensive review of building practices and regulations that assisted with the classification of the various typologies and building techniques.

1.1 Energy modelling

The environmental performance of Houston’s residential building stock relative to its ability to withstand climate change is studied through its *envelope exposure* and *envelope composition*. Envelope exposure is calculated as exposed-to-air or exposed-to-ground envelope (building envelope) area in m² over volume of conditioned air (thermal zone) in m³, resulting in a unitless number indicative of the building’s overall envelope exposure to external conditions. Envelope composition is classified per its calculated effective thermal resistance (R-Value) for opaque surfaces and its calculated effective thermal transmittance for windows (U-Value). Using existing census data, historical studies, and regulatory framework, the two classifications resulted in 14 predominant residential typologies that define envelope exposure and 5 effective regulations (or lack thereof) that define envelope composition. All 14 residential typologies were then simulated through all 5 envelope composition scenarios and 2 climatic contexts (one historical and one future), resulting in a total of 210 single-zoned shoebox simulated cases. All units are modelled with a 30% window-to-wall ratio on all exposed orientations. All occupancy and internal loads input parameters were normalized and remained same across all cases to neutralize their effect on the resulting heating and cooling loads. The attic, where present, is unconditioned. The thermostat was set at 18°C for heating and 24°C for cooling.

1.1.1 Houston residential stock and envelope exposure

Houston is the 4th largest city in the US with a density 1,389.36/km² (3,598.43/sq mi), 7.5 times lower than the density of New York NY and 3 times lower than the density of Berlin, Germany. Although there has been great development of multi-family and mixed-use buildings in recent years, the city’s residential stock is clearly dominated by single-family detached houses (Figure 4).

Taking this classification as a starting point, the authors reviewed the Houston Historic Preservation Manual (“Historic Preservation Manual” 2015) and cross referenced typologies with the ones found in the Aladdin and Sears catalogues and in the exhaustive Antique Home Style collection, to subdivide each category further to more strategically include distinct typologies in the area, such as shotgun homes, bungalows and ranch homes. The typologies used in the simulations are listed in Table 2. Dimensions used were derived from the inspection of the above sources and the Houston Realtors website. A comprehensive presentation documenting the array of residential buildings available in Harris County today and tracking trends in how this pool has changed in terms of age, type and location over the past decade can be found in Walker (2017).

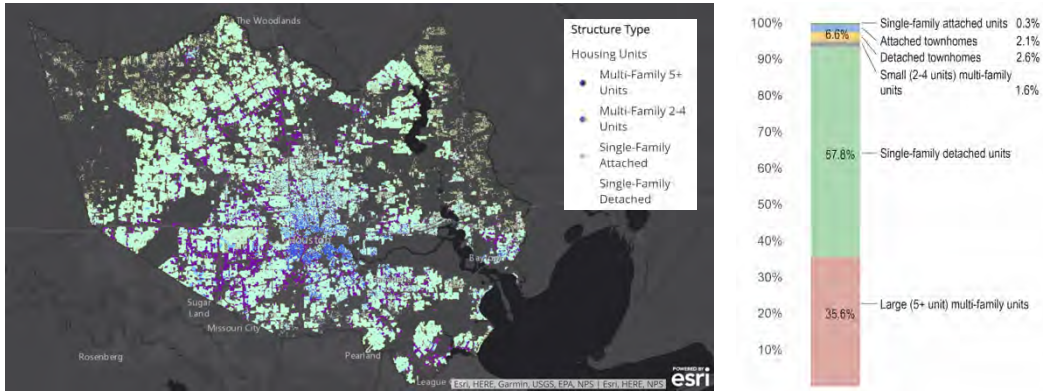

Figure 4: Type of structure of housing units in Houston, sources: Left (Walker 2017), right: Graph made by the authors using data from (John Park 2021)

Table 2: Residential typologies used in the energy modelling.

Description	Living Space m ² (sqft)	Total Volume m ³ (cft)	Conditioned Volume m ³ (cft)	Exposed Area m ² (sqft)	Exposure* m ² /m ³ (sqft/cft)	Simulation Identifier	North direction	Model: Conditioned area in green
Shotgun with attic and hipped roof	90(966)	272(9605)	202(7145)	269(2899)	1.33(0.4058)	T0		
Bungalow with attic and gable roof	81(867)	276(9762)	203(7159)	275(2955)	1.35(0.4128)	T1		
Bungalow with attic and gable roof	117(1258)	400(14134)	293(10357)	372(4009)	1.27(0.3871)	T2		
Ranch House two stories with attic and hipped roof	289(2900)	1022(36075)	882(30450)	604(6505)	0.7(0.2137)	T3		
Mansion	2020(21738)	16700(589740)	15325(541187)	5399(58109)	0.35(0.1074)	T4		
Mid-Rise Apartment (Interior Unit, Middle Floor)	209(2246)	783(26957)	783(26957)	60(641)	0.08(0.0238)	T5		
Mid-Rise Apartment (Corner Unit, Middle Floor)	297(3192)	1085(38301)	1085(38301)	120(1294)	0.11(0.0338)	T6		
Mid-Rise Apartment (Corner Unit, Top Floor)	297(3192)	1085(38301)	1085(38301)	417(4486)	0.38(0.1171)	T7		
Detached Four Stories Townhouse no attic	356(3827)	1138(40186)	1138(40186)	727(7827)	0.64(0.1948)	T8		
Attached Four Stories Townhouse no attic (Corner)	356(3827)	1138(40186)	1138(40186)	524(5643)	0.46(0.1404)	T9		
Detached Four Stories Townhouse no attic (Middle)	356(3827)	1138(40186)	1138(40186)	321(3459)	0.28(0.0861)	T10		
Detached Two Stories Townhouse with attic	255(2745)	972(34320)	855(30202)	628(6760)	0.73(0.2238)	T11		
Attached Three Stories Townhouse with attic (Corner)	255(2745)	972(34320)	855(30202)	502(5402)	0.59(0.1789)	T12		
Attached Three Stories Townhouse with attic (Middle)	255(2745)	972(34320)	855(30202)	376(4045)	0.44(0.1339)	T13		

1.1.2 Houston Building Code and envelope composition

The age of the housing stock is an indicator of its envelope composition based on effective building and energy regulations, assuming that most residential buildings are simply complying with the regulation and do not ignore or exceed minimum requirements. Older houses are less energy-efficient than newer homes because the envelope insulation levels are lower, and the potential for excessive heat transfer that will result in increased cooling loads is augmented. Harris County’s median year built was 1985, slightly older than the median of the state of TX. An extensive review of the historic record of the Houston building codes was performed to identify the major changes to the regulation that would have improved the energy performance of the residential units. The codes studied dated 1930, 1958, 1963, 1970, 1985, 1988, 1997, 2009 and 2016. After cross-referencing their mandates, 5 brackets were established to represent better major changes on building envelope transmittance values. Code minimum nominal R-Value requirements were then used to create envelope assemblies using THERM, which resulted in effective transmittance values per surface type. The values used in the simulated cases are listed in Table 3.

Table 3: Envelope transmittance values used in the energy modelling corresponding to different effective codes in Houston, TX.

Years	Reference	Wall assembly R value		Roof assembly R value		Floor assembly R value (if exposed to air)		Fenestration U value		Simulation Code ID
		IP (h*ft ² *°F/BTU)	SI (K*m ² /W)	IP (h*ft ² *°F/BTU)	SI (K*m ² /W)	IP (h*ft ² *°F/BTU)	SI (K*m ² /W)	IP (BTU/h*ft ² *°F)	SI (W/K·m ²)	
pre-1957	Historic documents and 1930 Houston Building Code	4.54	0.80	5.33	0.94	3.85	0.68	1.02	5.79	E0
1958-1985	1958 Houston Building Code	8.96	1.58	8.6	1.51	12.6	2.22	1.02	5.79	E1
1985-1997	1985 Houston Building Code	9.51	1.67	14.78	2.60	12.6	2.22	1.02	5.79	E2
1998-2016	1998 Houston Building Code	10.38	1.83	23.7	4.17	12.6	2.22	0.74	4.20	E3
post 2016	2012 Houston Residential Code	10.38	1.83	35.96	6.33	12.6	2.22	0.41	2.33	E4

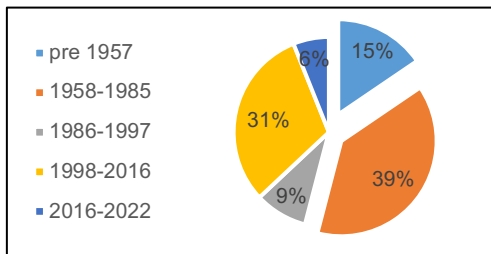

Figure 5: Distribution of the existing housing stock in Houston based on the year it was built. Based solely on the envelope transmittance values and the fact that pre-1985 structures have limited or no insulation, 54% of the residential stock is at most significant risk to increases in temperatures, with the 15% dating pre-1957 being the most vulnerable.

1.2. Houston residential stock city-scale mapping

In order to assess the risk of Houston’s existing housing stocks to climate change, city-scale maps were developed (Figure 6). The Harris County Appraisal District (HCAD) public database contains a comprehensive list of indicators used for tax collection. The database is continuously updated as permits are issued daily. At the time of the download for this study in October 2021, there were 1,229,440 records. Both the year when the structure was erected and the year of last remodel were extracted and mapped. The latter was used as indicative of some level of energy upgrade to comply to the code in effect at the time the permit was issued (per the city informal communication). The type of renovation is described in notes found under each record.

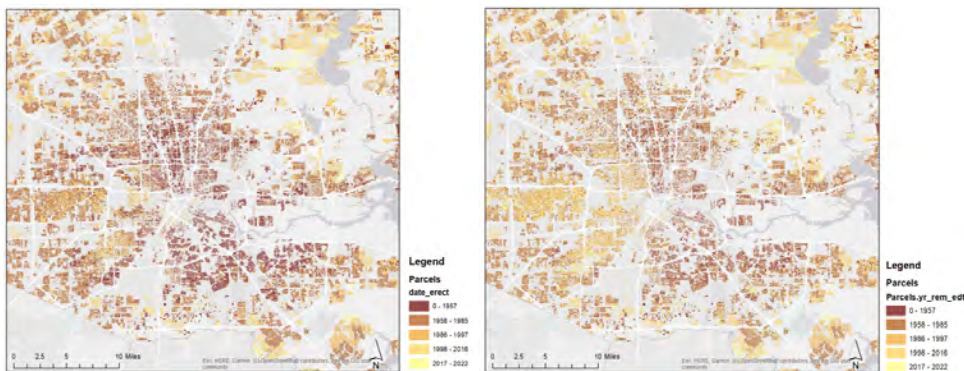

Figure 6: Map of Houston residential housing stock by year built (left) and year of last remodel (right). The latter was generated by maintaining the year unit was built if no remodel was recorded. Although remodels can be seen across town, the largest concentration is to the West side. The East side, home to several of the most vulnerable communities, remains predominantly in a pre-1957 stage.

For the assessment of risk to climate change, the age of the structure can be considered representative of the baseline, which means the worst-case scenario where no improvement was made to the energy efficiency since the original construction of the unit. The last year remodelled can instead be a first order approximation of some level of improvement to the structure’s energy efficiency. Although remodelling can be seen across town, the east parts of Houston is still dominated by homes in the pre-1957 conditions, hence more prone to being impacted by climate change. Those are in areas with a higher concentration of vulnerable communities. To extract the aforementioned indicators, two HCAD data sets were used: the Real Property Building Information (in tabular format); and the Tax Parcels (in GIS format). The tabular data do not include the geographical location of the records. These are found in the Tax Parcels shapefile. To create the city-scale maps shown in Figure 6, the tabular data were joined to the Tax Parcels in ArcMap using the common attribute HCAD 13-Digit Account Number. In the process, 58,976 (4.8%) residential records did not join because of lack of correspondent parcels.

2.0 Results

The results of the energy modelling simulation are shown in Figure 7. Building exposure is plotted against cooling and heating loads. The histograms plotted for the median envelope composition unit (E1) for all typologies at the bottom part of figure 7 decouple heating and cooling loads. Climate change scenarios result in increases in total loads (heating and cooling demand), 92% of which represent cooling loads on average. Heating loads are decreasing, and in a few instances, they are zeroing out (typologies T5 and T7). No single typology or level of exposure will be spared by the increase in energy loads due to the temperature changes forecasted by the year 2080. Even for units designed to current code (E4 labelled data), that is the case. The more exposed the envelope of the building the more prone to higher loads it is and the more vulnerable it becomes with climate change in mind across all typologies. The one-story standalone homes T0-T1-T2 representing the typical bungalow are the most impacted, with increases in cooling loads above 85% on average.

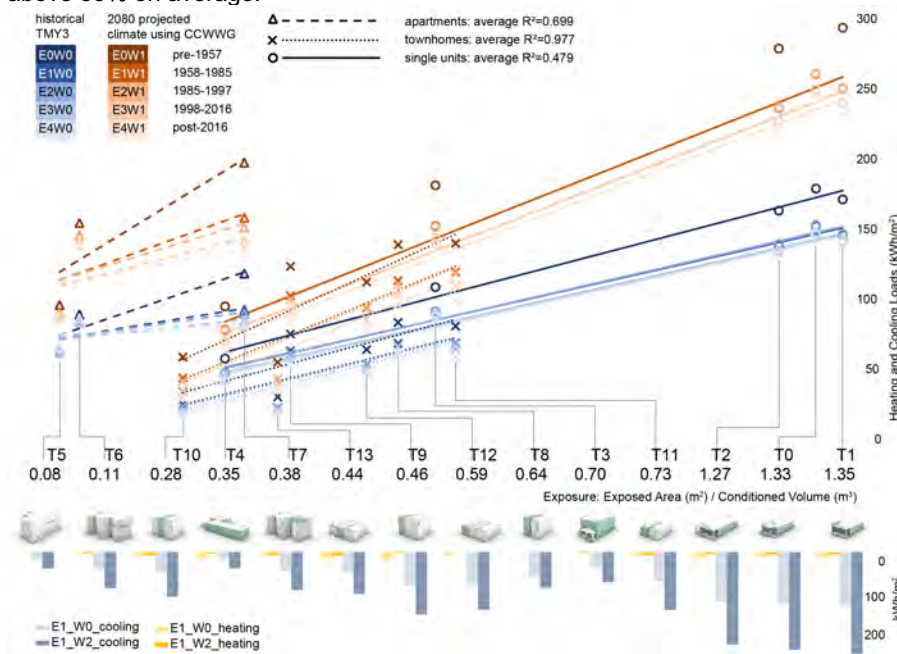

Figure 7: Upper chart: Building exposure plotted against heating and cooling loads for 140 simulated cases using the current TMY3 file and the 2080 CCWWG projected climate. Lower chart: Heating and cooling loads plotted separately for the current TMY3 file and the 2080 CCWWG projected climate for the median envelope composition (E1). The naming convention follows IDs as described in Tables 2 and 3.

To better understand the impact of exposure, trendlines were plotted per broader typology: apartments (T5-T7), townhomes (T8-T13) and single units (T0-T4). The regression lines of the single-family units exhibit the highest average R^2 value (0.977), as orientation remains consistent among studied cases, and all of them have an attic. Townhomes and apartments show an average R^2 value of 0.699 and 0.479, respectively. These lower values are attributed to window orientation differences, especially when this happens to the west; and to the roof exposure. T6 and T7 are therefore performing considerably worse than their exposure indicates. Withing each wider typology, the overarching trends are that exposure is almost linearly related to energy demand and that total (heating and cooling) loads are, on average, increasing by 66% in 2080 across all typologies, while cooling alone increases by 85%. The most compact units (T5, T10, T13) show the best resilience in climate change scenarios. Although their load demand increases by 68% in average, the numbers remain, for the most part, below 100kWh/m², relatively low compared to other typologies. On the other end of the spectrum, the most exposed units (T0, T1, T2) exhibit a similar 70% increase on average, but with loads often exceeding 250kWh/m², over two times higher than the compact units. Overall, envelope composition is more dominant for larger exposure and when the simulation is run with the 2080 projected climate files. This is particularly evident when looking at isolated typologies. In figure 8, three cases are isolated, one of low exposure (T4 exposure: 0.35), one of medium exposure (T3 exposure: 0.7), and one of high exposure (T1 exposure: 1.35). As exposure increases, the distribution among different envelope compositions is broader and more evident for the future climate change scenario.

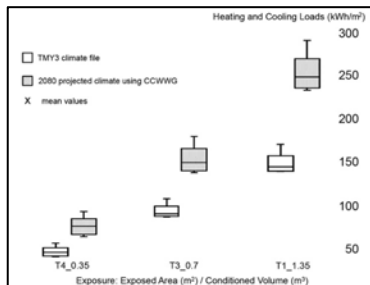

Figure 8: Box plot of heating and cooling load distribution using the current TMY3 file and the 2080 CCWWG projected climate for three exposure cases: T4: 0.35, T3: 0.7 and T1: 1.35. The naming convention follows IDs as described in Tables 2 and 3.

3.0 DISCUSSION

The outcome of the simulations portrays a rather grim prospect for Houston under climate change, with increases in energy demands required to maintain the current standard of indoor comfort that may be unsustainable for many. Mapping the different residential building age brackets in the greater Houston area (Figure 6) and correlating them with the changes in energy loads projected for 2080 (Figure 7) as well as with the typology (standalone versus attached) exposes the most vulnerable typologies and by inference, the communities most at risk of climate change. These areas are found to the East of town (Figure 3b) and correspond to a high Socio-Vulnerability Index (Figure 3a). They have the largest concentration of Hispanic and African American ("COH Planning Department Census Map Viewer " 2021) with median household incomes that do not exceed \$51,000 ("Household Income in Houston, Harris County, Texas Census County Division" 2018) and are dominated by pre-1957 single family houses, i.e. the most vulnerable to climate change (reference to type T0-T2 in Figure 7). There are about 249,892 residential units in those areas. Although not all dating pre-1957s, they are in the highest risk categories (pre-1985s). That put a rough estimate of about half a million people in danger of increasing temperatures and requiring prioritization in strategies to mitigate climate change effects.

It must be noted that this study relies on data that are subject to limitations suggested by the simulation inputs and the available public data on the housing stock in Houston. The sampling of the housing stock is representative of Houston but certainly not exhaustive. The single-zoned energy model with flat occupancy loads and schedules allowed for a comparative analysis that exposed the impact envelope composition and exposure can have overheating and cooling loads. Still, it resulted in building performance data that are not realistic or indicative of their energy use intensity (EUI). Variations that result from actual obstructions (shading or context), mechanical systems efficiencies, lighting power densities and other case-by-case variations are ignored. Also, the mapping of renovated residential units across Houston is based on the available data from the city permit centre and it assumes a "best case scenario" that energy upgrades accompany such renovations. Based on anecdotal data, this is not always the case. Lastly, although envelope exposure and transmittance are reliable starting points, other envelope related parameters such as orientation, the existence of unconditioned attic or the type of exposed surface (roof vs wall) contribute to the observed energy demand. Their effect was inferred in this study but not individually quantified.

CONCLUSION

This study was a first attempt to assess the magnitude of the impact of climate change and the current design approach on residential buildings in Houston. Through qualitative and quantitative analysis, it was demonstrated that Houston existing housing stock is, for the most part, inadequate to sustain the temperature increases forecasted by climate change. The climate data and energy simulation study using the current TMY3 weather file and the projected CCWorldWeatherGen weather data for 2080 shows a significant shift towards hotter temperatures and for a more extended period throughout the day and the year with correspondent underestimation of the required energy loads. With the current narrow definition of indoor comfort set by the ASHRAE (20-26C), infrastructure may not meet any excessive demand and ensure the current standards of indoor comfort and, therefore, the health of its occupants. All limitations of the analysis considered, this study confirms that: 1) continuing to design buildings in Houston with the current approach that does not consider climate change is not sufficient; 2) the current code requirements relative to building insulation are inadequate to address climate change; and demonstrates that: 1) the existing housing stock envelopes are not appropriate for the current weather conditions, let alone the ones forecasted for 2080, and 2) there is a correlation between the most at-risk residential buildings and communities, the latter as defined in Flanagan et al. (2018). The anticipated adoption of the International Building Code 2015 by April 2022 won't affect the energy code, which remains under the 2015 International Energy Conservation Code whose residential building thermal envelope criteria were used in this study for the "post-2016" type. These observations pose a threat to the most vulnerable communities found in Houston that often don't have air conditioning or cannot afford increases in energy bills. Most importantly, it might affect the entire energy grid, which needs to be prepared to afford excess demands. Building on these results, a more thorough assessment of the status of Houston's existing housing stock will be performed so that appropriate mitigation strategies can be identified.

ACKNOWLEDGEMENTS

The help of Gao Wenli, Reid I Boehm and Ethan M Conrad with ArcMap and data wrangling is gratefully acknowledged.

REFERENCES

- Belcher, S. E., J. N. Hacker, and D. S. Powell. 2005. "Constructing design weather data for future climates." *Building Services Engineering Research and Technology* 26 (1): 49-61. <https://doi.org/10.1191/0143624405bt1120a>.
<https://doi.org/10.1191/0143624405bt1120a>.
- Bethel, Heidi, Ken Sexton, Stephen Linder, George Delclos, Tom Stock, Stuart Abramson, Melissa Bondy, Matt Fraser, and Jonathan Ward. 2007. "A Closer Look at Air Pollution in Houston: Identifying Priority Health Risks."
- Busby, Joshua W., Kyri Baker, Morgan D. Bazilian, Alex Q. Gilbert, Emily Grubert, Varun Rai, Joshua D. Rhodes, Sarang Shidore, Caitlin A. Smith, and Michael E. Webber. 2021. "Cascading risks: Understanding the 2021 winter blackout in Texas." *Energy Research & Social Science* 77: 102106. <https://doi.org/https://doi.org/10.1016/j.erss.2021.102106>.
<https://www.sciencedirect.com/science/article/pii/S2214629621001997>.
- "COH Planning Department Census Map Viewer". 2021. Planning and Development Department. Accessed November 4. <https://mycity.maps.arcgis.com/apps/MapSeries/index.html?appid=0261236530b7493c9eea0b484e7a4135>.
- Crawley, Drury, Curtis Pedersen, Linda Lawrie, and Frederick Winkelmann. 2000. "EnergyPlus: Energy Simulation Program." *Ashrae Journal* 42: 49-56.
- Dickinson, Robert, and Benjamin Brannon. 2016. *Generating Future Weather Files for Resilience*.
- Douglas, Erin. 2020. "Houston has among most "newly poor" neighborhoods in nation." *Houston Chronicle*, 2020.
- Flanagan, Barry E., Elaine J. Hallisey, Erica Adams, and Amy Lavery. 2018. "Measuring Community Vulnerability to Natural and Anthropogenic Hazards: The Centers for Disease Control and Prevention's Social Vulnerability Index." *Journal of environmental health* 80 (10): 34-36. <https://pubmed.ncbi.nlm.nih.gov/32327766>
<https://www.ncbi.nlm.nih.gov/pmc/articles/PMC7179070/>.
- H-GAC. "2040 Regional Transportation Plan Demographics." Houston-Galveston Area Council H-GAC. Accessed October 22. <https://www.h-gac.com/regional-transportation-plan/2040/demographics>.
- "Historic Preservation Manual." 2015. City of Houston Planning and Development Department Accessed 11/2. <https://www.houstontx.gov/planning/HistoricPres/HistoricPreservationManual/index.html>.
- "Household Income in Houston, Harris County, Texas (Census County Division)." 2018. Statistical Atlas. Accessed November 4. <https://statisticalatlas.com/county-subdivision/Texas/Harris-County/Houston/Household-Income>.
- Houston Climate Action Plan 2020.
- Jentsch, Mark F., Patrick A. B. James, Leonidas Bourikas, and AbuBakr S. Bahaj. 2013. "Transforming existing weather data for worldwide locations to enable energy and building performance simulation under future climates." *Renewable Energy* 55: 514-524. <https://doi.org/https://doi.org/10.1016/j.renene.2012.12.049>.
<https://www.sciencedirect.com/science/article/pii/S0960148113000232>.
- John Park, Luis Guajardo. 2021. *Re-Taking Stock: Understanding How Trends in the Housing Stock and Gentrification are connected in Houston and Harris County*. (Rice University Kinder Institute for Urban Research). Dec. 12, 2015. *Paris Agreement to the United Nations Framework Convention on Climate Change*. T.I.A.S. No16-1104.
- Ramon, Delphine, Karen Allacker, Nicole Lipzig, Frank Troyer, and Hendrik Wouters. 2019. "Future Weather Data for Dynamic Building Energy Simulations: Overview of Available Data and Presentation of Newly Derived Data for Belgium." 111-138.
- Shandas, Vivek, Jackson Voelkel, Joseph Williams, and Jeremy Hoffman. 2019. "Integrating Satellite and Ground Measurements for Predicting Locations of Extreme Urban Heat." *Climate* 7 (1): 5. <https://www.mdpi.com/2225-1154/7/1/5>.
- Summary report 2020. CAPA Strategies LLC, Heat Watch.
- Vicedo-Cabrera, A. M., N. Scovronick, F. Sera, D. Royé, R. Schneider, A. Tobias, C. Astrom, Y. Guo, Y. Honda, D. M. Hondula, R. Abruzy, S. Tong, M. de Sousa Zanotti Stagliorio Coelho, P. H. Nascimento Saldiva, E. Lavigne, P. Matus Correa, N. Valdes Ortega, H. Kan, S. Osorio, J. Kyselý, A. Urban, H. Orru, E. Indermitte, J. J. K. Jaakkola, N. Rytí, M. Pascal, A. Schneider, K. Katsouyanni, E. Samoli, F. Mayvaneh, A. Entezari, P. Goodman, A. Zeka, P. Michelozzi, F. de' Donato, M. Hashizume, B. Alahmad, M. Hurtado Diaz, C. De La Cruz Valencia, A. Overcenco, D. Houthuijs, C. Ameling, S. Rao, F. Di Ruscio, G. Carrasco-Escobar, X. Seposo, S. Silva, J. Madureira, I. H. Holobaca, S. Fratianni, F. Acquaotta, H. Kim, W. Lee, C. Iniguez, B. Forsberg, M. S. Ragentli, Y. L. L. Guo, B. Y. Chen, S. Li, B. Armstrong, A. Aleman, A. Zanobetti, J. Schwartz, T. N. Dang, D. V. Dung, N. Gillett, A. Haines, M. Mengel, V. Huber, and A. Gasparrini. 2021. "The burden of heat-related mortality attributable to recent human-induced climate change." *Nature Climate Change* 11 (6): 492-500. <https://doi.org/10.1038/s41558-021-01058-x>. <https://doi.org/10.1038/s41558-021-01058-x>.
- Walker, Kelsey. 2017. *Taking Stock: Housing Trends in the Houston Area*. ricegis. <https://ricegis.maps.arcgis.com/apps/StorytellingSwipe/index.html?appid=12e35b0534644d569291f9be45771044>.
- WHO. 2015. "Heatwaves and health: guidance on warning-system development." WMO, WHO https://www.who.int/health-topics/heatwaves#tab=tab_1.
- Wilcox, S, and W Marion. 2008. *Users Manual for TMY3 Data Sets (Revised)*. (United States). <https://www.osti.gov/biblio/928611>

The Multi-Level Impacts of the Physical Environment on Childbirth Experience: A Critical Literature Review

Rafah Altaweli¹, Pravin Bhiwapurkar¹

¹University of Cincinnati, Cincinnati, OH

ABSTRACT: Childbirth, a physiological event that most women used to experience at home, is shifted to a hospital environment due to improved healthcare facilities in the last few decades. During this transition, increasing dissatisfaction with childbirth experiences is reported as the impact of the physical environment on women's perception of birth spaces is yet to be fully explored. Therefore, this review paper examines the literature based on the environment-behavior theory to answer the question of what are the most influential physical elements of birth spaces impacting the experience of childbirth by identifying the links between the physical elements and users' socio-cultural behaviors? This review employed a systematic search procedure using two combinations of keywords through databases such as CINAHL, PubMed, Jstor, Google Scholar, and Academic Complete. "women's satisfaction" OR "satisfaction level" OR "women's perception" AND ["childbirth experience" OR "birth experience"] OR ["spatial design" OR "built environment" OR "interior architecture" OR "physical environment" OR "birth space" OR "birth room" OR "labor room" OR "maternity unit" OR "maternity ward"]. A total of 5,539 publications were first screened through titles and abstracts. Only 42 actual studies and 2 systematic reviews met the inclusion criteria: reported an environment-normal childbirth experience relationship, published in English, full access, and peer-reviewed. The review confirmed that the physical environment impacted the women's childbirth experience; however, it is influenced by regional social and cultural practices. A multi-level impact (i.e., has a direct impact on childbirth experience and influence behaviors and performances, which increase its impact level) was significant in five physical elements: 1) the distance between labor/birth rooms and other areas, 2) designated spaces, 3) women's areas within birth rooms, 4) furnishings, and 5) design elements to control the atmosphere. The impact of the physical environment of the birth spaces combined with social and cultural practices of the region provides evidence to improve existing and future designs towards improved user experience.

KEYWORDS: Childbirth experience, Physical environment, Environmental impact, Public Health and Human-Centered Design, Literature review

INTRODUCTION

Childbirth is a physiological and natural event that is joyful, often painful, and sometimes traumatic. The United Nations (UN) estimated that the average number of babies born each year between 2020-2025 worldwide is around 697,668 thousand (United Nations 2021). Most of these births occur in hospitals, where regulations and standards of medical procedures are followed. While women with high-risk pregnancies benefited from medical practices, dissatisfaction with childbirth experiences rose among women with low-risk pregnancies. Many researchers investigated women's perceptions of childbirth experiences. Some found that the physical environment of birth spaces and the social and procedural practices have impacted women's perceptions of childbirth (Shah and Setola 2019). Based on the environment-behavior relationship theory (Rapoport 2005), the physical environment can influence human behaviors by allowing or blocking them—the mechanism of allowing and blocking behaviors rely on human cognitions of the surrounding built environment. For example, medicalized birth spaces that usually consist of a narrow clinical bed, monitors, operating light, ...etc., encourage the use of medical interventions during childbirth (Shah and Setola 2019). Human cognition would respond to physical clues, such as the medical equipment within the birth room. The existence of monitors, as an example, would give a hint that using them is encouraged, and women's mobility is discouraged. Many researchers reported that women are treated as passive objects with no control over the birth within a clinical environment (Lepori, Foureur, and Hastie 2008; Kempe, Noor-Aldin Alwazer, and Theorell 2010), which is explained and analyzed using the environment-behavior relationship theory. The links between the physical elements and users' socio-cultural behaviors within birth spaces could reveal the most influential physical factors impacting the childbirth experiences.

1.0 METHOD

This paper links the literature's findings of actual studies published between 2007 and 2020 on environmental factors impacting childbirth experience. The flow chart (Figure 1) shows the extensive literature search that was conducted in five databases: CINAHL, PubMed, Jstor, Google Scholar, and Academic Complete using two combinations of keywords: ("women's satisfaction" OR "satisfaction level" OR "women's perception") AND ("childbirth experience" OR

"birth experience"). A total of 5,359 publications were detected; however, after screening the titles and abstracts of these publications, the majority were excluded for duplication and/or non-relevant to the physical environment-normal childbirth experience relationship. Only 273 records were included for eligibility screening. A total of 33 publications met the inclusion criteria: if they reported a relationship between environmental factors (including physical elements and social and cultural practices) and vaginal childbirth experiences, published in English, full access, and peer-reviewed.

Few of the included studies examined the relationship between the physical environment and normal childbirth experiences; Therefore, a second search was conducted using a different combination of words: ("women's satisfaction" OR "satisfaction level" OR "women's perception") AND ("spatial design" OR "built environment" OR "interior architecture" OR "physical environment" OR "birth space" OR "birth room" OR "labor room" OR "maternity unit" OR "maternity ward"). A total of 180 publications came up. After screening the titles and abstracts and screening for eligibility, 14 publications were included.

This review includes 47 publications reporting 42 actual studies and 2 systematic reviews: 1) a review of 54 articles on satisfaction with childbirth experience (Srivastava et al. 2015), and 2) a systematic review of 80 studies associated with the impact of physical environments on intrapartum maternity care (Setola et al. 2019). In addition to a significant study spotted by exploring the reference lists (Block et al. 1981) reported the environment-companion experience relationship, which was lacking in the recent literature.

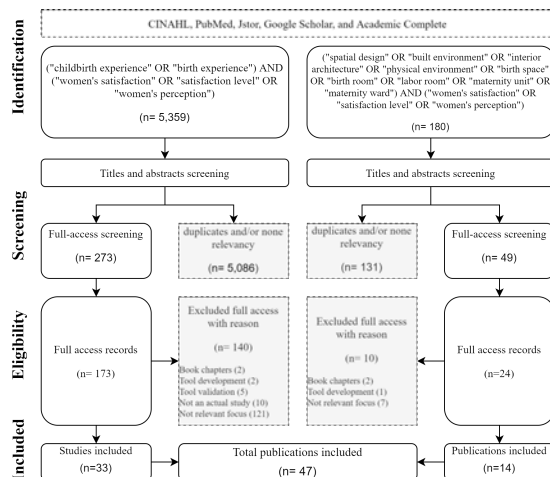

Figure 1: Flow chart of the systematic search procedure

2.0 FINDINGS

2.1. The multi-level impact of the birth environment

The environment, as conceptualized by Amos Rapoport (2005), consists of fixed, semi-fixed, and non-fixed elements: fixed elements are spaces, spatial layouts, and spatial elements, including walls, floors, ceilings, etc.; the semi-fixed elements are the movable physical elements, such as furnishings and sensory variables; and the non-fixed elements are the people occupying the space, their behavior, social interactions, activities, etc. Rapoport's conceptualization of the environment helps understand the linking mechanism between the elements by understanding what cognitive behavior is and how it is influenced (Rapoport 2005). The semi-fixed elements, such as movable furnishing, can act as cues perceived by the cognitive mind, allowing or blocking certain behaviors.

A recent systematic review showed that physical elements impacted birth space users directly and indirectly through their influence on human behavior and attitudes (i.e., social and cultural practices) (Setola et al. 2019). The physical environment of birth space impacts women, companions, and healthcare providers at the same time (Symon et al. 2008; Block et al. 1981). Another systematic review showed that the physical environment influences caregivers' attitudes and behaviors more than impacts women's birth satisfaction (Hodnett et al. 2009). This section will use the knowledge found in the literature and justify why women, out of all users' groups, are the most impacted by the physical environment. It is worth mentioning that women's demographics play a role in influencing the experience (Blazquez et al. 2019; Kempe, Noor-Aldin Alwazer, and Theorell 2010; Mekonnen, Yalew, and Anteneh 2015; Hassanzadeh et al. 2019); however, some studies showed no differences in results among different groups (Großkreutz et al. 2019; Halperin, Sarid, and Cwikel 2014). This paper is focused on the environmental factors and their impacts.

In architecture, the space syntax theory (Hillier 1996; Hillier and Hanson 1984) is relevant to the environment-behavior

theory in understanding the environment-behavior relationships (Rapoport 2005). Despite this, space syntax is insufficient in explaining socio-cultural meanings behinds human behavior as it prioritizes the spatial syntax over socio-cultural meanings (Netto 2016).

The environment-behavior relationship theory (Rapoport 2005), in combination with space syntax theory (Hillier 1996; Hillier and Hanson 1984), helps understand the dynamics/interaction between the physical environment and users' attitudes and behaviors (Haq and Luo 2012). Based on the environment-behavior relationship theory, the physical environment can encourage or discourage behaviors. It influences human cognition of the surrounding environment: what behavior is supported and what is not.

It is clear from the literature that there is a strong interrelationship between environmental factors and childbirth experiences. The users' satisfaction with childbirth was affected by four factors 1) the perception of the childbirth experience, 2) birth outcomes, 3) a companion's ability to help throughout the process, and 4) the performance and well-being of staff. In Table 1, each row represents the linked factors (i.e., the relationship between the physical environment [fixed and semi-fixed], social, and procedural practices [non-fixed]), which showed an influence the childbirth experiences. The first column states all physical factors divided into two parts- fixed and semi-fixed elements. The second column reflects the socio-cultural practices influenced directly by the physical elements in the first column. The third column shows the procedural practices that are prompted directly by the physical factors and indirectly by the socio-cultural practices.

Most fixed elements directly impact healthcare providers' performance and quality of care (i.e., socio-cultural practices), indirectly affecting women's experiences as they receive unnecessary medical interventions (e.g., cesarean sections). The semi-fixed elements directly impact healthcare providers' and companions' performance and the physical and psychological well-being of women, companions, and healthcare providers. The direct impacts of the semi-fixed elements influence the use of medical interventions (e.g., artificial oxytocin) and extend labor length, affecting women's perceptions and experiences of childbirth.

Table 1: The interrelationship between the physical environment and the socio-cultural and procedural practices
Non-fixed elements

	Physical factors	Socio-cultural practices	Procedural practices	
Fixed elements	Facility size (annual birth volume/total unit area)	- Flexibility & adaptability	Positive correlations with C-section rate	
	Room demand (annual birth volume/labor room)	- Quality of care		
	Overflow spaces (overflow beds/labor rooms)			
	The distance between	- Sense of pressure & comfort	Positive correlations with C-section rate	
	- Labor rooms	- Staff performances		
	- Labor rooms & workstations	- Sharing knowledge & workload		
	- Labor rooms & call rooms	- Positive correlations with the workload		
	Semi-fixed elements	Collaborative spaces (total staff area/total collaborative staff area)	- Negative correlations with the accessibility of clinicians	Negative correlations with the C-section rate
		The ratio of unit circulation designated as patient accessible/facility area	- Quality of care	
		The physical layout of workstations	- Staff performance	- Negative correlations with C-section & instrumental birth - Use of pharmaceutical pain relief - Labor length
Designated spaces:		- Sharing knowledge & workload		
Space to move around		Sense of comfort & mobility		
Space for companion		- Staff Performance		
Space for family members (communal lounge)		- Facilitating workflows		
Women's area (sleep area, private storage space, private bathroom (toilets/showers))		- Sense of freedom, control, mobility, privacy, & safety		
Kitchen		- Quality of care		
Outdoor spaces		-Support midwives' work capacity		
Ratios of overflow beds/labor rooms	- Sense of flexibility & adaptability	Negative correlations with C-section rate		
	- Quality of care			
Semi-fixed elements	Furnishings	- Support women	- Use of artificial oxytocin - Labor length	
	Standardization of labor rooms	- Staff performance		
	Clinical bed	- Communication & team decision making		
	Medical equipment (Prominence of technology)	- Ability to walk & to change birth positions		
	In bed-side documentation			
Birthing equipment				

Seating for companion & healthcare providers
Pool

- Sense of freedom, control, empowerment, mobility, & comfort
- Quality & type of care
- Support midwives' practice
- Well-being & performance
- Quality of care
- Sense of control, calm, relaxation, hygiene, & comfort
- Or the sense of anxiety, stress, discomfort

Unit atmosphere (i.e., feels)

Light - Indirect natural light (window, & controlling elements" blinds, or curtains") - Artificial lighting (dimmers control)

Temperature - Cooling & heating system (adjustable)

Ventilation - Ventilation system - large window (it can be opened)

Sound - Sound-reflecting ceiling tiles and sound-absorbing ceiling tiles- Hospital noise (e.g., monitor sounds) - Calming audio sounds (e.g., music)

Nature - Indoor nature (e.g., plants) - Nature stimuli -

Outdoor views of nature

This interrelationship generates a multi-level effect on users as they exist in the birth space simultaneously. Figure 2 visualizes the interactions between the key physical elements, that has multi-level impacts on women. It represents the behaviors influenced by these factors. The first level of influence, presented in the continuous arrow-headed line, is the physical environment's impact on the physical well-being and performance of women, companions, and healthcare providers. The second level of influence, presented in the thick dashed-arrow-headed line, is the effect of healthcare providers' behaviors on women and the performance of their companions. The third level of impact, shown in the fine dashed-arrow-headed line, is the influence of companions' performance on women's perception and experience.

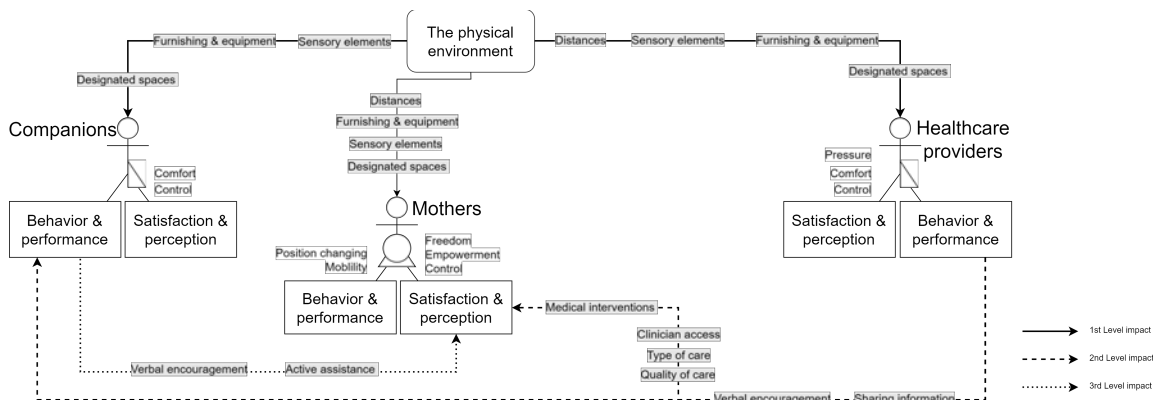

Figure 2: Visual representation of the interconnected impacts the physical environment has on mothers' childbirth experiences

2.2 The first level of impact

The direct impact of the spatial layout, spatial settings, and ambiance variables on socio-cultural practices considered the first level impact. The spatial layout, such as spatial qualities and distances between spaces, influences the socio-cultural practices: 1) increases the pressure to perform to speed up women birth, 2) increases the workload, 3) increases the negative performances of staff, 4) decreases the accessibility of clinicians, 5) facilitates flexibility and adaptability, 6) improves women' comfort, 7) encourages mobility that aid labor progress, and 7) influences the provision of care (Plough et al. 2019b, 2019a; Barnes L. 2007; Schreuder, Lebesque, and Bottenheft 2016; Harte et al. 2015; Tantchou 2018).

The spatial settings, such as the bed position, the bed type, educational posters, and the presence or absence of equipment, encourage 1) the upright position, 2) mobility, and 3) relaxation (Ayerle et al. 2018; McIntosh et al. 2018; Mekonnen, Yalew, and Anteneh 2015). For instance, 1) women mobility, 2) changing birth positions, 3) staff performance is encouraged by the existence of birth equipment and the presence of medical monitors (Shah and Setola 2019; Block et al. 1981; Symon et al. 2008b, 2008a; Hammond, Homer, and Foureur 2017). When midwives prepared the birth environment, including 1) the pool, 2) getting birth equipment ready, and 3) adjusting the room's temperature and light, it enhanced their performance (Hammond, Homer, and Foureur 2017).

The comfortable level of ambiance environment (the sensory elements), like the spatial elements, impact users' satisfaction and well-being. They influence psychological well-being and performance by promoting positive feelings: 1) control, 2) calm, 3) relaxation, 4) hygiene, and 5) comfort; or negative feelings: 1) anxiety, 2) stress, and 3) discomfort (Ayerle et al. 2018; McIntosh et al. 2018; Modl 2019; Plough et al. 2019a; Rudman, El-Khouri, and Waldenström 2007; Setola et al. 2019; Symon et al. 2008c; Folmer, Jangaard, and Buhl 2019; Simavli et al. 2014).

2.3 The second level of impact

The second level impact is when healthcare providers' behaviors influence the experiences of women and the performance of their companions. This impact embodies the psycho-social relationships (i.e., cultural behaviors and social interactions) among birth space users. Better psycho-social relationships positively impact psychological and physical well-being: 1) support, 2) respect, 3) trust, 4) confidence, and 5) empowerment. Cultural behaviors and social interactions consist of all encounters (verbal or non-verbal) within a birth space (Cross-Sudworth, Williams, and Herron-Marx 2011; Grigg et al. 2015; Overgaard, Fenger-Grøn, and Sandall 2012; Thies-Lagergren and Johansson 2019a; Kabakian-Khasholian et al. 2017). Non-verbal interactions, such as the performance of procedural practices. Unnecessary medical interventions impact women's experiences (Çalik, Karabulutlu, and Yavuz 2018; Tiznobaik et al. 2019). Verbal communication is represented in sharing information and verbal encouragement by healthcare providers and companions (Jahlan, Plummer, and McIntyre 2016; Donate-Manzanares et al. 2019; Luegmair et al. 2018; Ahmed 2020). Social environment influences differ from one cultural group to another (Halperin, Sarid, and Cwikel 2014). Culture plays a huge role in communication as part of the language, beliefs, and values (Karout et al. 2013; Barnes L. 2007). Furnishing for healthcare providers influences their well-being and performance (Orellana-Fitzgerald 2018).

2.4 The third level of impact

The influence of companions' performance on women's perception and experience is the third level impact of the physical environment. The role of a companion as the gatekeeper in helping the women prepare for and cope with childbirth (Block et al. 1981). Companions' active assistance during labor impacted women's ability to use coping techniques designed to decrease pain and increase satisfaction (Block et al. 1981). The companions' performance is considered a third-level impact, not second, due to the impact of healthcare providers' behaviors, interactions, and hospital policy on the companion's ability to perform actively during birth. Designated spaces that serve women and their companions assure privacy, where women and their companions can mobilize to the communal lounge (Abdallah 2018; König-Bachmann, Zenzmaier, and Schildberger 2019).

As shown in Table 1 and Figure 2, the most significant environmental factors that impacted women's childbirth experiences are the ones that influenced more than one user type and had multi-level implications. The key elements are: 1) the distance between labor/birth rooms and other areas, 2) designated spaces, 3) women's areas within birth rooms, 4) furnishings, and 5) design elements to control the atmosphere.

3.0 DISCUSSION

This review aims to detect the links between the physical elements of birth spaces and users' social and procedural practices based on the environment-behavior theory to identify the most influential physical elements. The complexity of the birth environment and the different views of childbirth steer the discussion.

3.1. The complexity of the birth environment-experience relationship

The complexity of the birth environment is caused by its multifunctionality. It is a workplace for healthcare providers, but it is an intimate space for women to feel vulnerable while giving birth. The literature showed that clinical settings, or worker-centered design, were not favored by women. One study showed the opposite, where women were more satisfied in a facility-based birth (Takayama et al. 2019). However, they were more satisfied when they gave birth in a "homey" or women-centered design (Perdok et al. 2018; Bernitz et al. 2016; Geerts et al. 2017). In clinical settings, women are the environmentally underprivileged group that adapts and adjusts their needs around the situation. Figure 3 represents the complexity of these relationships as the physical environment is influenced by the community culture (i.e., the culture context), affecting all users' behaviors (i.e., social and cultural practices). At the same time, the restriction applied by guidelines and hospital policy on socio-cultural and procedural practices of childbirth acts as reverse and resisting force to the physical environment. It changes the physical settings favoring the guided practices that might not support women's preferences regarding childbirth.

- Bernitz, Stine, Pål Øian, Leiv Sandvik, and Ellen Blix. 2016. "Evaluation of Satisfaction with Care in a Midwifery Unit and an Obstetric Unit: A Randomized Controlled Trial of Low-Risk Women." *BMC Pregnancy and Childbirth* 16 (1): 143. <https://doi.org/10.1186/s12884-016-0932-x>.
- Blazquez, Ruben, Esperanza Ferrandiz, Vicente Gea, and Caballero Rn. 2019. "Women ' s Satisfaction with Maternity Care during Preterm Birth," no. April: 1–8. <https://doi.org/10.1111/birt.12453>.
- Block, Carolyn R, Kathleen L Norr, Suzanne Meyering, James L Norr, and Allan G Charles. 1981. "Husband Gatekeeping in Childbirth." *Family Relations* 30 (2): 197–204. <https://doi.org/10.2307/584131>.
- Çalik, Kıymet Yeşilçiçek, Özlem Karabulutlu, and Canan Yavuz. 2018. "First Do No Harm - Interventions during Labor and Maternal Satisfaction: A Descriptive Cross-Sectional Study." *BMC Pregnancy and Childbirth* 18 (1): 415. <https://doi.org/10.1186/s12884-018-2054-0>.
- Cross-Sudworth, Fiona, Amanda Williams, and Sandy Herron-Marx. 2011. "Maternity Services in Multi-Cultural Britain: Using Q Methodology to Explore the Views of First- and Second-Generation Women of Pakistani Origin." *Midwifery* 27 (4): 458–68. <https://doi.org/10.1016/j.midw.2010.03.001>.
- Donate-Manzanares, Miriam, Teresa Rodríguez-Cano, Juan Gómez-Salgado, Julián Rodríguez-Almagro, Antonio Hernández-Martínez, Ester Barrilero-Fernández, and Luis Beato-Fernández. 2019. "Quality of Childbirth Care in Women Undergoing Labour: Satisfaction with Care Received and How It Changes over Time." *Journal of Clinical Medicine* 8 (4): 434. <https://doi.org/10.3390/jcm8040434>.
- Folmer, Mette Blicher, Karin Jangaard, and Henrik Buhl. 2019. "Design of Genuine Birth Environment: Midwives Intuitively Think in Terms of Evidence-Based Design Thinking." *Health Environments Research and Design Journal* 12 (2): 71–86. <https://doi.org/10.1177/1937586718796654>.
- Geerts, Caroline C, Jeroen van Dillen, Trudy Klomp, Antoine L M Lagro-Janssen, and Ank de Jonge. 2017. "Satisfaction with Caregivers during Labour among Low Risk Women in the Netherlands: The Association with Planned Place of Birth and Transfer of Care during Labour." *BMC Pregnancy and Childbirth* 17 (1): 229. <https://doi.org/10.1186/s12884-017-1410-9>.
- Goodman, Petra, Marlene C. Mackey, and Abbas S. Tavakoli. 2004. "Factors Related to Childbirth Satisfaction." *Journal of Advanced Nursing* 46 (2): 212–19. <https://doi.org/10.1111/j.1365-2648.2003.02981.x>.
- Grigg, Celia P., Sally K. Tracy, Virginia Schmied, Rea Daellenbach, and Mary Kensington. 2015. "Women's Birthplace Decision-Making, the Role of Confidence: Part of the Evaluating Maternity Units Study, New Zealand." *Midwifery* 31 (6): 597–605. <https://doi.org/10.1016/j.midw.2015.02.006>.
- Großkreutz, B Gürbüz C, M Vortel T Borde, R C Rancourt H Stepan, and O Sauzet W Henrich. 2019. "The Influence of Migration on Women ' s Satisfaction during Pregnancy and Birth : Results of a Comparative Prospective Study with the Migrant Friendly Maternity Care Questionnaire (MFMCQ)," 555–67.
- Halperin, Ofra, O. Sarid, and J. Cwikel. 2014. "A Comparison of Israeli Jewish and Arab Women's Birth Perceptions." *Midwifery* 30 (7): 853–61. <https://doi.org/10.1016/j.midw.2013.11.003>.
- Hammond, Athena, Caroline S.E. Homer, and Maralyn Foureur. 2017. "Friendliness, Functionality and Freedom: Design Characteristics That Support Midwifery Practice in the Hospital Setting." *Midwifery* 50 (July): 133–38. <https://doi.org/10.1016/j.midw.2017.03.025>.
- Haq, Saif, and Yang Luo. 2012. "Space Syntax in Healthcare Facilities Research: A Review." *Health Environments Research and Design Journal* 5 (4): 98–117. <https://doi.org/10.1177/193758671200500409>.
- Harte, J. Davis, Athena Sheehan, Susan C. Stewart, and Maralyn Foureur. 2015. "Childbirth Supporters' Experiences in a Built Hospital Birth Environment: Exploring Inhibiting and Facilitating Factors in Negotiating the Supporter Role." *Health Environments Research and Design Journal* 9 (3): 135–61. <https://doi.org/10.1177/1937586715622006>.
- Hassanzadeh, Robab, Fatemeh Abbas-alizadeh, Shahla Meedy, and Sakineh Mohammad-alizadeh-charandabi. 2019. "Assessment of Childbirth Preparation Classes : A Parallel Convergent Mixed Study," 1–8.
- Hillier, Bill. 1996. *Space Is the Machine: A Configurational Theory of Architecture*. Cambridge University Press.
- Hillier, Bill, and Julienne Hanson. 1984. *The Social Logic of Space*. Cambridge University.
- Hodnett, Ellen D., Robyn Stremler, Julie A. Weston, and Patricia McKeever. 2009. "Re-Conceptualizing the Hospital Labor Room: The PLACE (Pregnant and Laboring in an Ambient Clinical Environment) Pilot Trial." *Birth* 36 (2): 159–66. <https://doi.org/10.1111/j.1523-536X.2009.00311.x>.
- Jahlan, Ibtisam, Virginia Plummer, and Meredith McIntyre. 2016. "What Women Have to Say about Giving Birth in Saudi Arabia." *Middle East Journal of Nursing*. Vol. 10. <https://doi.org/10.5742/mejn.2015.92779>.
- Kabakian-Khasholian, Tamar, Hyam Bashour, Amina El-Nemer, Mayada Kharouf, Salah Sheikha, Nasser El Lakany, Rafik Barakat, et al. 2017. "Women's Satisfaction and Perception of Control in Childbirth in Three Arab Countries." *Reproductive Health Matters* 25: S16–26. <https://www-jstor-org.proxy.libraries.uc.edu/stable/26495966>.
- Karout, N., S.H. Abdelaziz, M. Goda, S. AlTuwaijri, N. Almostafa, R. Ashour, and H. Alradi. 2013. "Cultural Diversity: A Qualitative Study on Saudi Arabian Women's Experience and Perception of Maternal Health Services." *Journal of Nursing Education and Practice* 3 (11): 172–82. <https://doi.org/10.5430/jnep.v3n11p172>.
- Kempe, Annica, Fatoom A. Noor-Aldin Alwazer, and Töres Theorell. 2010. "Women's Authority during Childbirth and Safe Motherhood in Yemen." *Sexual and Reproductive Healthcare* 1 (4): 129–34. <https://doi.org/10.1016/j.srhc.2010.07.001>.
- König-Bachmann, Martina, Christoph Zenzmaier, and Barbara Schildberger. 2019. "Health Professionals' Views on Maternity Care for Women with Physical Disabilities: A Qualitative Study." *BMC Health Services Research* 19 (1): 1–11. <https://doi.org/10.1186/s12913-019-4380-y>.
- Lepori, Bianca, Maralyn Jean Foureur, and Carolyn Ruth Hastie. 2008. "Mindbodyspirit Architecture: Creating Birth Space." In *Birth Territory and Midwifery Guardianship: Theory for Practice, Education and Research*, edited by Kathleen Fahy, Maralyn Foureur, and Carolyn Hastie, 95–111. Sydney: Elsevier Limited.

- Luegmair, Karolina, Christoph Zenzmaier, Claudia Oblasser, and Martina König-Bachmann. 2018. "Women's Satisfaction with Care at the Birthplace in Austria: Evaluation of the Babies Born Better Survey National Dataset." *Midwifery* 59 (March 2017): 130–40. <https://doi.org/10.1016/j.midw.2018.01.003>.
- McIntosh, Nathalie, Patricia Gruits, Eva Oppel, and Amie Shao. 2018. "Built Spaces and Features Associated with User Satisfaction in Maternity Waiting Homes in Malawi." *Midwifery* 62 (March): 96–103. <https://doi.org/10.1016/j.midw.2018.03.020>.
- Mekonnen, Mesafint Ewunetu, Worku Awoke Yalew, and Zelalem Alamrew Anteneh. 2015. "Women's Satisfaction with Childbirth Care in Felege Hiwot Referral Hospital, Bahir Dar City, Northwest Ethiopia, 2014: Cross Sectional Study." *BMC Research Notes* 8 (October): 528. <https://doi.org/10.1186/s13104-015-1494-0>.
- Modl, Alison. 2019. "Epigenetic Rooted Architecture: A Typology for Obstetrical Programming." Laurentian University.
- Netto, Vinicius M. 2016. "What Is Space Syntax Not? Reflections on Space Syntax as Sociospatial Theory." *Urban Design International* 21 (1): 25–40. <https://doi.org/10.1057/udi.2015.21>.
- Orellana-Fitzgerald, Paz. 2018. "Privacy, Dignity, and Integrity: A Material Culture Analysis of What Space and Technology Affords the Neonatal Nurse." University of Alberta.
- Overgaard, Charlotte, Morten Fenger-Grøn, and Jane Sandall. 2012. "The Impact of Birthplace on Women's Birth Experiences and Perceptions of Care." *Social Science & Medicine* 74 (7): 973–81. <https://doi.org/10.1016/j.socscimed.2011.12.023>.
- Perdok, Hilde, Corine J Verhoeven, Jeroen van Dillen, Tjerk Jan Schuitmaker, Karla Hoogendoorn, Jolanda Colli, François G Schellevis, and Ank de Jonge. 2018. "Continuity of Care Is an Important and Distinct Aspect of Childbirth Experience: Findings of a Survey Evaluating Experienced Continuity of Care, Experienced Quality of Care and Women's Perception of Labor." *BMC Pregnancy and Childbirth* 18 (1): 13. <https://doi.org/10.1186/s12884-017-1615-y>.
- Plough, Avery, Deb Polzin-Rosenberg, Grace Galvin, Amie Shao, Brendan Sullivan, Natalie Henrich, and Neel T. Shah. 2019a. "An Exploratory Study of the Relationship between Facility Design and the Provision of Childbirth Care." *Journal of Midwifery and Women's Health* 64 (1): 12–17. <https://doi.org/10.1111/jmwh.12920>.
- . 2019b. "Assessing the Feasibility of Measuring Variation in Facility Design Among American Childbirth Facilities." *Health Environments Research and Design Journal* 12 (2): 30–43. <https://doi.org/10.1177/1937586718796641>.
- Rapoport, Amos. 2005. *Culture, Architecture, and Design*. Chicago: Locke Science Publishing Company.
- Rudman, Ann, Bassam El-Khouiri, and Ulla Waldenström. 2007. "Women's Satisfaction with Intrapartum Care - A Pattern Approach." *Journal of Advanced Nursing* 59 (5): 474–87. <https://doi.org/10.1111/j.1365-2648.2007.04323.x>.
- Schreuder, Eliane, Layla Lebesque, and Charelle Bottenheft. 2016. "Healing Environments: What Design Factors Really Matter According to Patients? An Exploratory Analysis." *Health Environments Research and Design Journal* 10 (1): 87–105. <https://doi.org/10.1177/1937586716643951>.
- Setola, Nicoletta, Eletta Naldi, Grazia Giulia Cocina, Liv Bodil Eide, Laura Iannuzzi, and Deirdre Daly. 2019. "The Impact of the Physical Environment on Intrapartum Maternity Care: Identification of Eight Crucial Building Spaces." *Health Environments Research and Design Journal* 12 (4): 67–98. <https://doi.org/10.1177/1937586719826058>.
- Shah, Nell, and Nicoletta Setola. 2019. "Designing Space and Place of Birth." In *Squaring the Circle: Researching Normal Birth in a Technological Age*, edited by Soo Downe and Sheena Byrom, 1st ed., 219–30. London: Pinter & Martin Limited.
- Simavli, Serap, Ikbak Kaygusuz, Ilknur Gumus, Betül Usluogullari, Melahat Yildirim, Hasan Kafali, Betül Usluogulları, Melahat Yildirim, and Hasan Kafali. 2014. "Effect of Music Therapy during Vaginal Delivery on Postpartum Pain Relief and Mental Health." *Journal of Affective Disorders* 156 (March): 194–99. <https://doi.org/10.1016/j.jad.2013.12.027>.
- Srivastava, Aradhana, Bilal I. Avan, Preeti Rajbangshi, and Sanghita Bhattacharyya. 2015. "Determinants of Women's Satisfaction with Maternal Health Care: A Review of Literature from Developing Countries." *BMC Pregnancy and Childbirth* 15 (1): 1–12. <https://doi.org/10.1186/s12884-015-0525-0>.
- Symon, Andrew, Jeanette Paul, Maggie Butchart, Val Carr, and Pat Dugard. 2008a. "Maternity Unit Design : Background to Multi-Site Study in England." *British Journal of Midwifery*, no. 1: 29–34.
- . 2008b. "Maternity Unit Design Study Part 2 Perceptions of Space and Layout." *British Journal of Midwifery*, no. 2.
- . 2008c. "Maternity Unit Design Study Part 3 : Environmental Comfort and Control." *British Journal of Midwifery* 16 (3): 167–72. <https://doi.org/10.12968/bjom.2008.16.3.28691>.
- . 2008d. "Maternity Unit Design Study Part 4: Midwives' Perceptions of Staff Facilities." *British Journal of Midwifery* 16 (4): 228–31. <https://doi.org/10.12968/bjom.2008.16.4.29046>.
- Takayama, Tomomi, Khampheng Phongluxa, Daisuke Nonaka, Chika Sato, Ernesto R Gregorio Jr, Nouhak Inthavong, Tiengkham Pongvongsa, Sengchanh Kounnavong, and Jun Kobayashi. 2019. "Is the Place of Birth Related to the Mother's Satisfaction with Childbirth? A Cross-Sectional Study in a Rural District of the Lao People's Democratic Republic (Lao PDR)." *BMC Pregnancy and Childbirth* 19 (1): 333. <https://doi.org/10.1186/s12884-019-2483-4>.
- Tantchou, Josiane Carine. 2018. "The Materiality of Care and Nurses' Attitude Problem." *Science Technology and Human Values* 43 (2): 270–301. <https://doi.org/10.1177/0162243917714868>.
- Thies-Lagergren, Li, and Margareta Johansson. 2019a. "Intrapartum Midwifery Care Impact Swedish Couple's Birth Experiences — A Cross-Sectional Study." *Women and Birth*. <https://doi.org/10.1016/j.wombi.2018.08.163>.
- . 2019b. "Intrapartum Midwifery Care Impact Swedish Couple's Birth Experiences — A Cross-Sectional Study." *Women and Birth* 32 (3): 213–20. <https://doi.org/10.1016/j.wombi.2018.08.163>.
- Tiznobaik, Azita, Mehrnaz Geranmayeh, Zohreh Khakbazan, and Ziba Taghizadeh. 2019. "Factors Affecting Maternal Satisfaction with Vaginal Delivery: A Qualitative Study" 14.
- United Nations. 2021. "World Population Prospects - Population Division." <https://population.un.org/wpp/DataQuery/>.

Exploring the Impacts of Human-Centric Lighting Spatial Patterns on Elderly Residents mood and preference – An Architectural Content Analysis

Nasrin Golshany¹, Ihab Elzeyadi¹

¹University of Oregon, Eugene, OR

ABSTRACT: The aging population is growing rapidly. The population is aged 65 and older increasing from 9 percent in 2019 to 16 percent by 2050, which means one in every six people in the world will be aged 65 or older. One of the problems of an aging population is that older adults are at higher risk for sleep dysfunctions, anxiety disorders, and depression leading to mental stress and cognitive impairments. Studies have shown that lighting parameters are among the most significant indoor environmental qualities that can potentially play an important role in improving health and wellbeing in older adults. Human-Centric light is an approach in lighting design, which investigates the impact of different variables of lighting such as temporal pattern, light level, the light spectrum and, the spatial pattern on both visual and non-visual outcomes of humans. While previous studies have investigated the impact of different light variables on elderly visual and non-visual outcomes, there is a critical need to identify the impact of spatial patterns of light on elderly residents' outcomes. This study is an initial effort in recognizing and developing a spatial pattern framework that can be used as a design pattern to guide spatial light patterns relating to elderly people's preferences and moods. After a picture content analysis of 36 images of assisted living facilities living rooms and bedrooms, the Visual Attention Software (3M-VAS) was used to identify the most efficient visual hierarchy in the images according to lighting elements and furniture arrangements. The main contribution of this study is the creation of a proposed spatial pattern framework that can be used as a design pattern to guide spatial light patterns relating to elderly people's preferences and moods. Findings from this research will provide new insights into the scope of human-centric lighting design of assisted living facilities.

KEYWORDS: human-centric lighting, lighting design, spatial pattern, elderly people, cognitive function

INTRODUCTION

Appropriate lighting condition is one of the significant indoor environmental qualities that could potentially play an important role in improving the living environment and enhancing health and wellbeing in older adults (Lu et al., 2019). Lighting design for the elderly settings, however, has not received much attention from researchers and designers. Human-Centric light is a new approach in lighting design, which focuses not only on the visual impact of light, but also on its non-visual aspects that influence circadian rhythms, sleep, mood, and cognitive performance. Houser, K. W., et al (2020) have defined four main categories of lighting variables that contribute independently through designing lighting systems for the built environment: Temporal pattern (i.e., the timing and duration of exposure), Light level (i.e., the quantity of light in radiometric and photometric units), Light spectrum (SPD) (i.e., spectral power distribution that governs color quality) and spatial patterns (i.e., the luminance distribution of the three-dimensional light field). Illuminance, an important quantitative attribute of lighting, has been shown to have a positive impact on individuals' alertness, vitality, task performance, agitation, depression, sleep quality, and cognitive performance (Satlin et al., 1992; Yamadera et al., 2000; Riemersma et al., 2008). In addition to Illuminance, researchers have proposed different metrics for quantifying the effectiveness of the non-visual and psychological impact of light on the human body. Equivalent Melanopic Lux (EML) is a more recent metric developed after Lucas et al (2014) to measure the biological impacts of light on humans' bodies. Studies investigating the impact of the light spectrum have shown both monochromatic short-wavelength light and blue-enriched polychromatic light are more effective than longer wavelengths of light at suppressing melatonin (Brainard et al., 2001), regulating the circadian clock (Revell et al., 2005), and enhancing alerting effects and improving mood (Chellappa et al., 2011). There is firm evidence among building science researchers that the temporal pattern of electric light in the indoor environment that follows the same natural pattern of daylight (morning bright light, dim evening light) provide a better non-visual outcome for humans, especially for elderly people (Yamadera et al., 2000; Riemersma et al., 2008; Figueiro, 2008).

Existing studies in the field of human-centric lighting for elderly people have mainly focused on quantitative attributes of light such as light level (Sinoo, 2010; Figueiro, 2011); light spectrum (Janosik & Marczak, 2016; Cheng, 2016; Sean et al., 2020); and temporal patterns of light (Gasio et al., 2003; Figueiro, 2008), while there are not enough studies showing a systematic relationship between qualitative attributes of light such as the spatial pattern and luminance distribution with nonvisual outcomes of elderlies (Knez, I., & Kers, C, 2000; Riemersma et al, 2008; Yamadera, et

al,2000). A vast majority of gerontology studies have addressed the visual impacts of indoor lighting on wayfinding, mobility, and task performance, while there is a significant gap in understanding the impact of indoor lighting on the nonvisual outcomes of elderly people as mood, behavior, and preference. To address the research gaps in this area and particularly investigate the impact of spatial patterns on mood and preference, this study aims to initially identify the most common spatial patterns of light in existing elderly facilities. Next, the patterns will be modified and combined with the extracted spatial pattern attributes of light from the literature to provide a more holistic approach towards the creation of a proposed lighting spatial pattern framework.









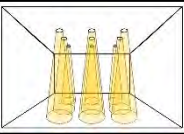

1. FLYNN'S THEORY (SPATIAL PATTERN OF LIGHT AND HUMAN SUBJECTIVE IMPRESSION)

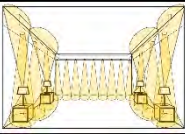
A number of studies in the field of subjective lighting impressions show that inferior retinal light exposure is more effective than superior retinal exposure in suppression melatonin (Glickman et al., 2003) and light exposure on the nasal side of the retina is more effective in biological responses than the temporal side of the retina (Visser,1999). Therefore, the way that light radiation reaches the human eye is very important in its effect on visual and non-visual outcomes. Lighting designs for visual outcomes are at task locations and are often oriented horizontally (DiLaura, D. L., et al, 2011), while non-visual lighting designs are at the plane of the occupant's eyes and are oriented vertically (Houser & Esposito, 2021; Brown et al., 2020).

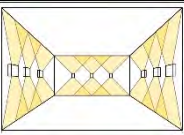
The spatial pattern of light refers to the spatial distribution of light in the three-dimensional light field and it depends on many parameters of light and environment. In the 1970s, John Flynn published a series of articles (Flynn & JE, F., 1977; Flynn et al., 1979; Flynn et al., 1973); conducted fundamental research about the role of the distribution of light and resulting patterns of the light on human subjective impressions. Flynn et al (1979) defined four main lighting modes in space, which make various impressions in humans. These four lighting modes are the basic attributes that designers consider when they are creating an environment for different purposes: bright/dim, uniform/non-uniform, central / perimeter, and warm/cool. Flynn particularly examined how different "lighting modes" affects Spaciousness / Confinement, Visual Clarity / Haziness, Relaxation / Activation and Private/ Public.

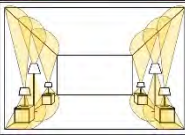
Flynn et al (1973) defined six different light arrangements which had their specific uniformity, centrality, and brightness value so that each arrangement correspond to a specific point in a dimensional space of the different lighting characteristics. The results of this study indicated that there is a significant difference in human subjective impression between different lighting arrangements. According to Flynn's theory of lighting and mood in the 1970s we have defined six main spatial patterns of light that contribute to humans' mood and preference. These six spatial patterns of light have been created according to three main attributes including Spatial arrangement (uniform/non-uniform, centrality (central/perimeter) and, direction. (Table 1)

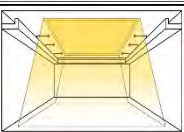
Table 1: Spatial lighting patterns according to Flynn's theory of lighting and mood (after Flynn, 1973)

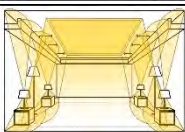
	<i>Spatial arrangement</i>	<i>Flynn's theory arrangement</i>	<i>Proposed spatial lighting arrangement</i>		<i>Spatial arrangement</i>	<i>Flynn's theory arrangement</i>	<i>Proposed spatial lighting arrangement</i>
1	Uniform Central Direct			4	Nonuniform Peripheral Direct/indirect		
2	Nonuniform Peripheral Indirect			5	Nonuniform Peripheral Indirect		
3	Uniform Central Indirect			6	Nonuniform Central/Peripheral Direct/indirect		

Previous studies regarding the spatial pattern of light have mainly focused on the relationship between the control parameters of light and the spatial distribution of light and how it impacts human outcomes. In this section, we have reviewed and discussed spatial arrangement (uniform/non-uniform, centrality (central/perimeter) and, the direction of light as three main independent variables of the spatial pattern of light and their impacts on mood, preference, perception, behavior, performance, and other outcomes of the human according to the literature

1.1 Spatial Arrangement (Uniformity)

Luminaire position in an environment can be arranged in two different ways: Uniform and Non-uniform. In a uniform arrangement, all the lighting luminaires in a room are placed in maximum height and uniform spacing without considering the location of furniture and other architectural elements to illuminate the environment at about the same level. In a non-uniform lighting system, all the fixtures are located at a high level and close to the ceiling, but with irregular spacing. The exact location of each fixture depends on the place of the workstations and machinery and the task that will be performed in that space.

Hawkes et al. (1979) argued two main attributes of light define the perception of light in a space, namely brightness, and interest. Brightness refers to the perceived intensity of light while interest is related to perceived uniformity. There is evidence that shows that task lighting can increase attention to desk works, which improves task performance (Rea et al., 1990). Taylor et al. (1975) found that nonuniform desktop illumination improved task performance. This study shows adults perform better in arithmetic calculations (on paper) in office spaces with nonuniform lighting in comparison to uniform fluorescent lighting or very nonuniform colored lighting. On the other hand, some other studies are indicating there is no correlation between uniformity of light and task performance. McKennan & Parry. (1984) shows different illuminance levels on the desk-based on different lighting distribution does not impact (paper-based) clerical task performance in a comparison of 10 different general and local/general combined lighting installations. Lighting design in theatres shows that areas of high luminance could help to attract the audience's attention, but there is no firm evidence to show how this mechanism can be implemented to provide appropriate conditions for different tasks in other settings (Veitch, 2001). There is a study that investigated the impact of position and number of the light sources on perception of the space atmosphere. position of the light in this study refers to the location of light in the room (symmetrically, left-right, and front-back). The results indicate that adjacent luminaires to walls create a less uniform atmosphere (Stokkermans et al., 2018). In another study, affective impressions of university students were evaluated concerning spatial patterns and luminous environments in their classrooms. They defined six different axes of effective impressions of students including Surprising-amazing; Clear-efficient; Cheerful-colorful; Uniform; Intense brilliant and Warm-cozy. The result showed that Writing-reading tasks need a positioning of light that generate Clear-efficient, Intense-brilliant, and Uniform pattern, Reflecting-discussing tasks require a positioning of light that generates a Warm-cozy atmosphere, and Paying attention task needs a light positioning that creates Clear-efficient, Uniform, and Surprising-amazing atmospheres (Castilla et al., 2018). There are also other studies investigating the impact of spatial arrangement and uniformity on human perception, behavior, and preference (Flynn et al., 1973; Flynn et al., 1979; Chraibi, et al., 2017; Stokkermans et al., 2018). Flynn et al. (1973) and Flynn et al. (1979) as indicated in table 1 showed that uniformity in the spatial pattern of light increases clarity in space, while non-uniformity contributes to more relaxing feelings. Yao et al. (2017) that argues uniformity is a critical attribute of indoor lighting in work efficiency and comfort, have investigated different methods for evaluating uniformity of light in space. These methods include: (Min: Avg), the coefficient of variance (CV), entropy uniformity (EU, introduced in the article), and a pattern vision-based indicator (U_{HVS}). According to the literature, illuminance distribution in a space can direct attention of the occupant in useful ways. In addition it impacts visual and non-visual performance. Despite these findings, there is a lack of evidence to show how uniform or non-uniform light can impact the mood and preference of a human.

Centrality (central/ peripheral)

Light sources in a space can be arranged to emphasize horizontal surfaces (central, overhead), or vertical surfaces (perimeter). Flynn et al. (1973) also revealed that in addition to light intensity (dim – bright dimension of light) and interest (uniform and non-uniform dimension of light), there is another factor that impacts the perception of light in a space, namely peripheral – overhead. Flynn showed central arrangement with Higher light levels on horizontal surfaces such as work plane provide more visual clarity, and Uniform peripheral lighting make the space more spacious, while peripheral non-uniform lighting is more helpful in increasing relaxation and privacy (Flynn et al., 1973; Flynn et al., 1979). Another study investigating the impact of the different spatial patterns of light in university classrooms on students' performance showed that each particular pattern of light (central or peripheral) should be modified according to the specific task taking place in the class (Castilla et al, 2018).

Lighting Direction

Luminaires can be designed to focus light in one of the following ways: Direct Lighting, Semi-Direct Lighting, General Lighting, Semi-Indirect Lighting, and Indirect Lighting. Indirect lighting, 90 to 100 percent of light radiation from the luminaire reaches the work surface. This type of lighting is a very common lighting design specially for task lighting. The main problem of direct lighting is that it causes glare and unfavorable shadows. In a semi-direct lighting system, 60 to 90 percent of light sources reach the working surface and the remainder of the light is reflected toward the ceiling or wall. In general lighting, the light will be distributed equally in both upper and lower areas of space (Lighting methods, 2017). Semi-indirect lighting, unlike semi-direct, reflects 60 to 90 percent of light toward the ceiling, while 30 to 40 percent only reach the working surface. In indirect lighting, 90 to 100 of light reflects toward the ceiling that increasing diffusion and even distribution. Studies have shown that people prefer indirect lighting in comparison with systems providing direct lighting (Veitch et al., 2008;). Yearout & Konz (1989) found that indirect direct lighting is more favorable than direct lighting among participants doing tasks in the workstation. Operators also prefer brighter illumination in office space and spotlights on walls. Katzev (1992) also showed office employees prefer direct/indirect lighting more than other lighting

systems, while there were no significant differences between participants' performance in cognitive/intellectual tasks. A recent study investigating the impact of direct and indirect light on health, well-being, and cognitive performance of office workers also demonstrates except for a relationship between reduced job stress severity and direct lighting, there is no meaningful correlation between direct and indirect lighting and cognitive performance (Fostervold & Nersveen, 2008). Another study that investigated the impact of light direction on office workers' satisfaction, visual health, and productivity demonstrates that satisfaction and other subjective lighting rates were higher in an indirect lighting system, while productivity was less influenced by the direction of light (Hedge, et al, 1995). Another study that investigated the impact of lighting positioning in workstations has found that two different spatial patterns (varies in terms of number, direction, and position of the light) create different views while do not impact the performance of the users. This study shows that a combination of direct and indirect light is more favorable for the users. They also preferred a non-uniform spotlight on wall painting (Yearout & Konz, 1989).

Various studies investigating the impact of the spatial patterns of light on elderly outcomes have mainly focused on one or two attributes of spatial pattern. However, there is a critical need for a comprehensive investigation of the impact of the spatial pattern of light on elderly outcomes. Furthermore, most of the previous studies have not sufficiently addressed the architectural and design perspective of the spatial patterns of light and have mainly examined the spatial pattern of light in an experimental room. To address this critical gap this study has used a multi-method approach to investigate spatial patterns of light in senior residence facilities.

MULTI-METHOD APPROACH TO INVESTIGATE SPATIAL LIGHT PATTERNS

In this study, architectural content analysis has been conducted by an inductive approach through three main phases. In phase 1, a Picture Content Analysis (PCA) was conducted for surveyed facilities' websites to determine the most common layout arrangements and properties for Bedrooms and Living Rooms of Assisted living facilities in the US. This phase resulted in the most common typologies of each of the two rooms. In phase 2, Visual Attention Software (3M-VAS) software analyzed the most common room typologies from phase 1 to determine which typology is the most attractive to users and can generate the most viewing interest. In phase 3, the two most attractive views of each room--based on phase 2 analysis--were selected to implement spatial lighting patterns according to Flynn's theory of lighting and mood (Flynn et al., 1973)

Picture Content Analysis

In the first phase of the study, to identify the most common layout arrangement, interior lighting quality, and spatial patterns of light in existing senior residence facilities, we conducted a picture content analysis of the online image stocks from surveyed assisted living facilities website. Quantitative or formal content analysis is an empirical method for systematic analysis of different media content such as audio, textual, visual, and/or audiovisual (Krippendorf, 2004; Rössler, 2005). This systematic observational method aims to examine hypotheses about the representation of an event, people, and situations in different media (Fielding et al., 2008). To conduct a picture content analysis main unit, sample unit, unit of analysis, and codebook should be defined. In this study, the main unit of analysis consists of all the images of 50 elderly residents' facilities websites in the US. In the first step, we selected 36 images of assisted living facilities' living rooms (18) and bedrooms (18) as the sample unit of the analysis. Images were selected based on the type of facilities (assisted living facilities), interior space (living room and bedrooms), areas of the spaces (living room < 1000 sq ft; bedroom < 450 sq ft), and lighting quality of spaces (including the different spatial patterns of light). The images including the human figures were also excluded from the sample unit to decrease distraction in content analysis. In the second step, five different subjective categories were defined for coding the images of the first phase. These categories include the possibility of having daylight, home likeness, including colorful furniture, the existence of natural elements, and warmth. (Figure 1 and 2). Five images with the highest score of these coding categories were selected for the final visual content analysis via 3M VAS software in phase 2.

Visual Attention Analysis – (3M VAS)

In phase 2 five final images were analyzed by 3M VAS software to investigate which image has met the visual hierarchy goals for our study. 3M-VAS (Visual Attention Software) is a biometric tool that collected and clustered 30 years of eye-tracking data (Salingaros and Sussman, 2020). This software that is mostly applied in website and signage design analyses the images according to three different attributes: heatmap, hotspots, and gaze sequences. The results of analyzing the five final images of the bedroom and living rooms have been indicated in Figures 1 and 2.

1.1.1 Heatmap

This attribute shows the probability a part of visual content is seen within 3-5 seconds of seeing a picture. Among 5 selected images of the living room, room number four with more attention on lighting fixtures and seating area rather than other elements of the room get the higher scores in this analysis. Between 5 images of the bedrooms room, number five with the main focus of heating map on lighting fixtures and bed shows the most attractive typology.

1.1.2 Hotspots

This criterion is a simplified version of the heatmap results which shows the areas of the image that is most likely to be seen. The probability of being seen by a person will be shown by a numeric score on each region of the image. Hotspot

analysis among living rooms indicated that Image number 1 and number 4 by 85% and 92% focus on seating areas and 51% and 85% on lighting elements have the highest scores among five different images. Comparative analysis among bedrooms images hotspots revealed that room number 2 and number 4 by 69% and 42% attention on lighting fixtures and 77% and 97% focus on beds can generate the most viewing interest.

1.1.3 Gaze sequence

This parameter shows the four most-likely gaze locations, in their most-probable viewing order. This criterion is important because it shows the visual hierarchy of the scene. For this study, we are looking for a gaze sequence in a scene that attracts the users' attention to lighting fixtures and the significant elements of the room (seating area in the living room and bed in bedrooms). Among five images of living rooms, room number four's gaze sequence shows the most rational sequence: 1- desk light, 2- ceiling light, 3- desk light and, 4- seating area. The gaze sequence analysis among bedroom images also indicated that image number 2 by a gaze sequence from bed to desk light and then to ceiling light and window has a most reasonable hierarchy among room's elements in the scene.



Figure 1 (right): Picture content analysis and visual attention analysis of the Livingroom's images

Figure 2 (left): Picture content analysis and visual attention analysis of the bedroom's images

Proposed Spatial Lighting Patterns

In the final phase, the two most likable typologies of each room were selected to implement spatial lighting patterns according to Flynn's theory of lighting and mood. First, a virtual space of the living room and bedroom was simulated according to these two most attractive typologies in Autodesk 3ds Max software. Light level and light spectrum in each space were simulated according to the recommended amounts based on the literature (illuminance: 500 lux for living room and 300 lux for bedrooms; CCT:4500 k). Second, six main spatial patterns of light according to Flynn's theory of lighting and mood were implemented in each room to create the final proposal spatial pattern framework in assisted living facilities living rooms, and bedrooms (Figure 3).

The results of this architectural content analysis show that the dominant lighting fixtures in living rooms of assisted living facilities are chandeliers, recessed lighting, and table shade lamps, while in bedrooms ceiling fans and bedside lamps are more common. Although that we have included the images of spaces by the possibility of having daylight, there are a vast majority of facilities without any access to daylight. Elderly residents in assisted living facilities spend 90% of their time in indoor spaces therefore, they are experiencing dimmer days and brighter nights than what they need to experience in nature. The results of visual attention analysis indicated that spatial patterns of light in many of these facilities have created a glare that can be seen in the images. Although glare can create discomfort for all age groups, it takes more time for elderly people to recovery glare effect and can impact their efficiency and activation. The final spatial pattern framework can be implemented in future studies to investigate the impact of different attributes such as centrality, uniformity, and direction of light on both visual and non-visual outcomes of elderly people.

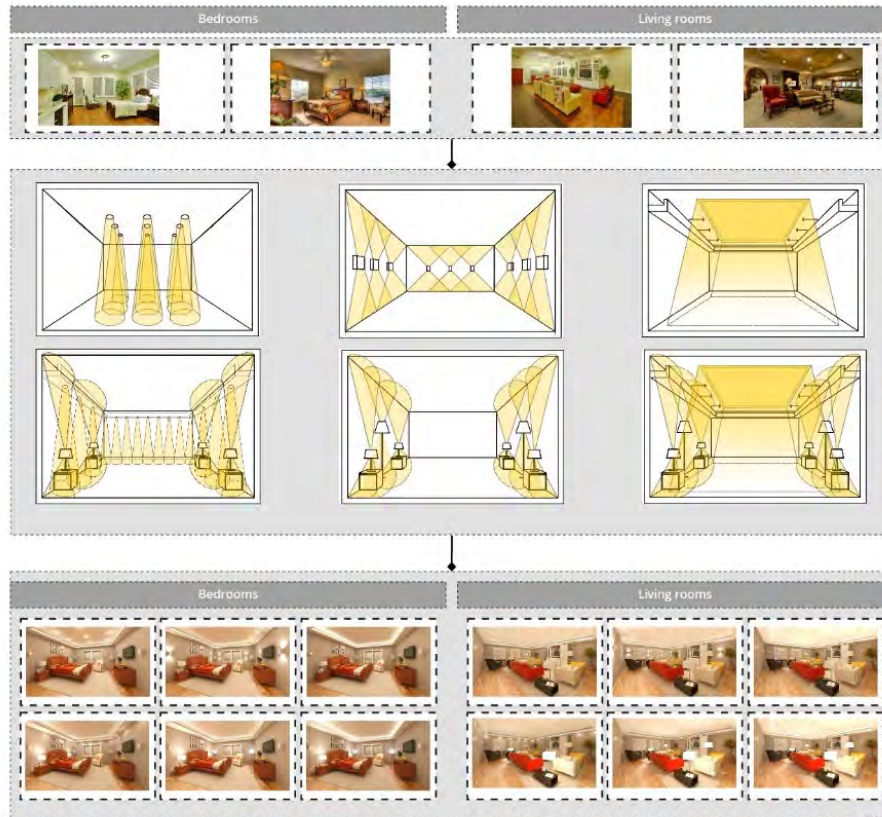

Figure 3: Spatial pattern framework in assisted living facilities living rooms and bedrooms

The impact of spatial pattern of light on elderly people’s mood and preference

The two most likable and common typology of bedrooms and living rooms that selected will be modified according to an actual assisted living facility. An online survey including familiar-looking pictures of interior spaces which have been simulated based on 24(6 spatial patterns*2 CCT* 2types of interior spaces) lighting modes with different spatial and spectral patterns will be sent to elderly people of this facility. Participants will be sked to rate their subjective impression including mood, preference, and aesthetic qualities of images through different questions. Spatial patterns include uniform/non-uniform, central/perimeter and direct/indirect patterns and light spectrum includes CCT (2800 k and 4500k).

CONCLUSIONS AND FUTURE STUDIES

Despite the significant impact on the relationship between spatial light patterns and light radiation from the occupant’s perspective, currently there is a lack of evidence-based design applications that implement these findings. This knowledge gap suggests a need for further studies investigating affect of spatial light patterns on both visual and non-visual outcomes of elderly people especially mood, behavior and cognitive performance.

This study is an initial step in recognizing and developing a spatial lighting pattern framework that can be used as a design pattern to guide future lighting design application in settings. The findings of the study can play an important role in providing new insight into the field of human-centric lighting. To address the existing gap regarding the influence of the light spatial patterns on elderlies’ non-visual outcomes the final simulated images of this study can be used as a valid and replicable reference of spatial patterns of light in senior living facilities.

The finding of this study can be combined with the results of previous studies regarding the light level, light spectrum, and temporal patterns of light to provide a more integrative framework of lighting design in assisted living facilities that can be used in experimental studies of the future.

REFERENCES

- Brainard, G. C., D. Sliney, J. P. Hanifin, G. Glickman, B. Byrne, J. N. Greeson, S. Jasser, E. Gerner, and M. D. Rollag. "Sensitivity of the Human Circadian System to Short-Wavelength (420-Nm) Light." [In English]. *Journal of Biological Rhythms* 23, no. 5 (Oct 2008): 379-86.
- Cain, S. W., E. M. McGlashan, P. Vidasfar, J. Mustafowska, S. P. N. Curran, X. R. Wang, A. Mohamed, V. Kalavally, and A. J. K. Phillips. "Evening Home Lighting Adversely Impacts the Circadian System and Sleep." [In English]. *Scientific Reports* 10, no. 1 (Nov 2020): 10.
- Castilla, N., C. Linares, F. Bisegna, and V. Blanca-Gimenez. "Emotional Evaluation of Lighting in University Classrooms: A Preliminary Study." [In English]. *Frontiers of Architectural Research* 7, no. 4 (Dec 2018): 600-09.
- Chellappa, Sarah Laxhmi, Roland Steiner, Peter Blattner, Peter Oelhafen, Thomas Götz, Christian Cajochen, and Michael H. Herzog. "Non-Visual Effects of Light on Melatonin, Alertness and Cognitive Performance: Can Blue-Enriched Light Keep Us Alert?." *PLoS one*. 6, no. 1 (2011): e16429.
- Cheng, Z. J., Q. C. Zhao, F. L. Wang, Y. Jiang, L. Xia, and J. L. Ding. "Satisfaction Based Q-Learning for Integrated Lighting and Blind Control." [In English]. *Energy and Buildings* 127 (Sep 2016): 43-55.
- Fielding, Nigel G., Raymond M. Lee, and Grant Blank, eds. *The SAGE handbook of online research methods*. Sage, 2008.
- Figueiro, M. G. "A Proposed 24 H Lighting Scheme for Older Adults." [In English]. *Lighting Research & Technology* 40, no. 2 (2008): 153-60.
- Figueiro, M. G., B. Plitnick, M. S. Rea, and L. Z. Gras. "Lighting and Perceptual Cues: Effects on Gait Measures of Older Adults at High and Low Risk for Falls." [In English]. *Bmc Geriatrics* 11 (2011): 10.
- Flynn, John E., Clyde Hendrick, Terry Spencer, and Osyp Martyniuk. "A Guide to Methodology Procedures for Measuring Subjective Impressions in Lighting." *Journal of the Illuminating Engineering Society* 8, no. 2 (1979): 95-110.
- Flynn, John E., Terry J. Spencer, Osyp Martyniuk, and Clyde Hendrick. "Interim Study of Procedures for Investigating the Effect of Light on Impression and Behavior." *Journal of the Illuminating Engineering Society* 3, no. 1 (1973): 87-94.
- Flynn, John E., and FLYNN JE. "A study of subjective responses to low energy and nonuniform lighting systems." (1977).
- Gasio, P. F., K. Krauchi, C. Cajochen, E. van Someren, I. Amrhein, M. Pache, E. Savaskan, and A. Wirz-Justice. "Dawn-Dusk Simulation Light Therapy of Disturbed Circadian Rest-Activity Cycles in Demented Elderly." [In English]. *Experimental Gerontology* 38, no. 1-2 (Jan-Feb 2003): 207-16.
- Janosik, Elżbieta, and Wojciech Marczak. "The Effect of Warm and Cool Lighting on Visual Performance of Elderly Workers." *Zeszyty Naukowe Politechniki Poznańskiej Organizacja i Zarządzanie* (2016): 51-67.
- Knez, I., and C. Kers. "Effects of Indoor Lighting, Gender, and Age on Mood and Cognitive Performance." [In English]. *Environment and Behavior* 32, no. 6 (Nov 2000): 817-31.
- Lu, Xiaojie, Nam-Kyu Park, and Sherry Ahrentzen. "Lighting Effects on Older Adults' Visual and Nonvisual Performance: A Systematic Review." *Journal of housing for the elderly*. 33, no. 3 (2019): 298-324.
- Lucas, R. J., S. N. Peirson, D. M. Berson, T. M. Brown, H. M. Cooper, C. A. Czeisler, M. G. Figueiro, et al. "Measuring and Using Light in the Melanopsin Age." [In English]. *Trends in Neurosciences* 37, no. 1 (Jan 2014): 1-9.
- Revell, V. L., J. Arendt, M. Terman, and D. J. Skene. "Short-Wavelength Sensitivity of the Human Circadian System to Phase-Advancing Light." [In English]. *Journal of Biological Rhythms* 20, no. 3 (Jun 2005): 270-72.
- Riemersma-van Der Lek, R. F., D. F. Swaab, J. Twisk, E. M. Hol, W. J. G. Hoogendijk, and E. J. W. Van Someren. "Effect of Bright Light and Melatonin on Cognitive and Noncognitive Function in Elderly Residents of Group Care Facilities - a Randomized Controlled Trial." [In English]. *Jama-Journal of the American Medical Association* 299, no. 22 (Jun 2008): 2642-55.
- Rössler, Patrick. "Inhaltsanalyse [Content analysis]." *Konstanz, Germany: UVK/UTB* (2005).
- Sinoo, M. M., H. S. M. Kort, and M. S. H. Duijnste. "Visual Functioning in Nursing Home Residents: Information in Client Records." [In English]. *Journal of Clinical Nursing* 21, no. 13-14 (Jul 2012): 1913-21.
- Stokkermans, M., I. Vogels, Y. de Kort, and I. Heynderickx. "Relation between the Perceived Atmosphere of a Lit Environment and Perceptual Attributes of Light." *Lighting research & technology* / 50, no. 8 (2018): 1164-78.
- Visser, E. K., D. G. M. Beersma, and S. Daan. "Melatonin Suppression by Light in Humans Is Maximal When the Nasal Part of the Retina Is Illuminated." [In English]. *Journal of Biological Rhythms* 14, no. 2 (Apr 1999): 116-21.
- Yamadera, H., T. Ito, H. Suzuki, K. Asayama, R. Ito, and S. Endo. "Effects of Bright Light on Cognitive and Sleep-Wake (Circadian) Rhythm Disturbances in Alzheimer-Type Dementia." [In English]. *Psychiatry and Clinical Neurosciences* 54, no. 3 (Jun 2000): 352-53.
- Yearout, Robert, and Stephan Konz. "Visual Display Unit Workstation Lighting." *International journal of industrial ergonomics* 3, no. 3 (1989): 265-73.

Exploring the Role of Human Perception: A Comparative Analysis of Human Thermal Comfort and Urban Design Parameters

Naveed Mazhar¹, Enrica Dall'Ara², Brian Robert Sinclair²

¹NAIT, Edmonton, AB

² University of Calgary, Calgary, AB

ABSTRACT: Weather is arguably the most important factor of thermal comfort, both as an actual and perceived component, from a user's viewpoint. The received energy, real or presumed, by the user is highly decisive in how well an outdoor space is used. The present study illuminates the human perceptual mechanisms involved in an urban open environment and human thermal comfort assessment, with an emphasis on hot climates. The primary objective is to identify underlying conditions influencing people's behavior in and usage of outdoor spaces. An in-depth literature review lucidly demonstrated that a physiological approach alone is inadequate in characterizing human thermal comfort conditions. Therefore, embracing a holistic approach, a novel conceptual model is proposed, tentatively aligning direct and indirect factors of influence. The model is qualitatively focused, and will subsequently be tested by an empirical study, performed in the Walled City of Lahore, Pakistan. This study will decipher the influences of both weather parameters (e.g., air temperature, wind, and solar radiation) and personal factors (e.g., place perception, emotions, sensations, and behaviors) on participants' emotional estimations of urban open spaces. Age and gender are some of the demographics considered in the analysis. Users of urban open spaces being the fulcrum, the intended human versus machine conceptual framework is a robust side-by-side comparative analysis of the unique domains of science and social science. Fused with the physical design components, the model is distinguished by the simultaneous and equal assessment of the two basic characteristics of empirical measurements and subjective human feelings. The scope of the study is innovative, distinctive, and unprecedented in the context of hot climate cities. Therefore, it presents a significant and contributory step towards a greater understanding of the psychological dimension influencing weather assessment and consequently human behaviour in the urban environment, projecting implications on urban design.

KEYWORDS: Global Sustainability, Inclusive Urban Landscapes, Microclimate, Human Behaviour, Urban Design

Introduction

Weather fundamentally affects the level and comfort of human activity in outdoor urban environments. As a result, the parallel investigation between received and perceived weather is a very important factor for both the use and perception of outdoor urban spaces (Bekele, Jones, & Rajamani, 2008; Kántor, Unger, & Gulyás, 2012; Lenzholzer & Brown, 2013). It is established that designing climate-sensitive outdoor urban places may have a positive social effect besides health, social, economical, and environmental benefits (Givoni, 1998; Graham, Vanos, Kenny, & Brown, 2017). In the last twenty years, researchers have focused on and fused the psychological variables involved in outdoor spaces alongside weather parameters (Hoppe, 2002; Hoppe & Seidl, 1991; Nikolopoulou, Baker, & Steemers, 2001; Nikolopoulou & Lykoudis, 2006a; Nikolopoulou & Steemers, 2003; Thorsson, Lindqvist, & Lindqvist, 2004). This shift in research approach aimed to achieve more holistic, inclusive, and balanced findings on human thermal comfort. In line with this, some findings have recently indicated that the processes of weather assessment may have been found to be intertwined with psychological and cultural processes (Knez & Thorsson, 2006, 2008) rather than being identifiable through the general thermal indices alone as suggested by the physiological heat balance models (Coccolo, Kämpf, Scartezzini, & Pearlmutter, 2016a; Hoppe, 2002). Therefore, expanding the concept of thermal comfort to embrace psychological/cultural aspects and spatial feeling is one of the key goals of the present research. The hypothesis of the present study is that: There is a direct relationship between thermal adaptation to reach thermal comfort and different levels of a sense of place in urban spaces.

To quantify human thermal perception (thermal comfort), more than 100 different indices (Igor Knez, Thorsson, Eliasson, & Lindberg, 2009) have been developed over the years, predominantly defining the amount of heat exchanged between a human body and its surrounding environment (Jendritzky, De Dear, & Havenith, 201). These models may be classified into three main streams: empirical indices, thermal indices, and linear equation indices. The first simplified model developed was based on the interactions of two simple meteorological variables. This was followed in the 1930s by Gagge's model, a first ever attempt to apply the principles of thermodynamics to the energy exchanged between the human body and its thermal environment (Coccolo, Kämpf, Scartezzini, & Pearlmutter, 2016b). Givoni, during the seventies, further refined the thermal comfort model by developing the Index of Thermal Stress. Later, during

the 1970s, Fanger developed the Predicted Mean Vote, which is a well-recognized standard to quantify indoor human thermal comfort perceptions. Indoor human thermal comfort was already being examined and quantified consistently owing to the stable nature of the indoor environments. Conversely, quantifying the precise impact of an outdoor environment on human thermal comfort is still a challenge (Hoppe, 2002; Jendritzky et al., 2012). None of the over 100 indices nor the new Universal Thermal Climate Index-UTCI (www.utci.org) – which is presently in progress by an initiative of the International Society of Biometeorology – take into account the psychological variables involved in outdoor thermal perceptions.

Given the above, the aim of this paper is to clarify the psychological mechanisms involved in the human experience of outdoor spaces and weather assessments by proposing a conceptual model suggesting direct and indirect links of influence in an outdoor place–human relationship. This work is part of an on-going doctoral research at the School of Architecture, Planning, and Landscape (SAPL), University of Calgary. The objective and ambition is to integrate and enhance the knowledge of the complex relationship between climate and human behaviour and its implications for sustainable urban design in a hot, arid urban environment.

1.0 PSYCHOLOGICAL AND ENVIRONMENTAL ASSESSMENT

The term ‘adaptation’ may be defined as the steady waning of an organism’s response when exposure to a stimulus is gradually increasing. In connection with human thermal comfort, this draws in all the processes a user may go through to find a fit with the environment. A series of articles (Nikolopoulou et al., 2001; Nikolopoulou & Lykoudis, 2006a; Nikolopoulou & Steemers, 2003) have suggested that a) a purely physiological approach is inadequate and b) conditions influencing human behaviour and perceptions may account for some of the unexplained variances between objective and subjective thermal comfort assessments. In the transitional seasons, these parameters may influence both the experiences and expectations of the subjects’ thermal behaviours from the preceding seasons. Other factors included in the studies were naturalness, time of exposure, perceived control, and environmental stimulation. Of the variables to be assessed, “experience”, is of great significance for the understanding of the human factor. Place, experience and exposure (temporal dimensions) are central to human thermal comfort and the resulting behaviour in an outdoor open environment (Eliasson, Knez, Westerberg, Thorsson, & Lindberg, 2007; Knez, 2005a). Due to this, environmental assessment does not only involve thermal comfort estimations and psychological adaptations, but also the experience and time, which have a central role to the holistic understanding of a given outdoor setting (Igor Knez et al., 2009).

Humans tend to think, visualize and rationalize through a set of information gathering processes, which is typically through recognizing a physical stimulus (seeing, hearing, smelling, tasting, and touching) and conscious involvement of its experience (Eysenck & Keane, 2020; Kitchin, 1994). According to the length of exposure, the human sensory system (where received information is further processed) transforms this knowledge into pockets of cognitive and meaningful information. It is also established that any information stored in the human brain for 30 seconds or less, by definition, is explained as short-term memory. Thus, we know that short-term human memory has a very limited capacity where the sensory data is cognitively identified, named, and held for a maximum of no more than half a minute. If short-term memory is “here and now”, long-term memory, on the other hand, may be explained as the psychological “past” that gives us the meaning of the places we engage with, because this is where all our experiences and knowledge (from facts to personal events) are stored. Long-term memory is organized into several different memory systems storing declarative (factual knowledge and experiences of which we are directly aware) and procedural (know-how skills such as how to walk and ride a bicycle) types of information. Hence any visual and experiential information that has been held longer, rehearsed, and elaborated through consistent exposure will be considered in this study.

Actually, it is important to acquire deeper and equitable knowledge about the long-term spatial perceptions or “schemata” as they are known to have significant influence on the human behavioral responses and acceptance or avoidance of places (Lenzholzer, 2010). Furthermore, long-term spatial perceptions, as pointed out by (Lenzholzer, 2012)(Igor Knez et al., 2009; Nikolopoulou et al., 2001), have a crucial impact on thermal sensation. A European study based on a survey of more than 10,000 people shows how neutral sensation could vary by 10 °C between Athens (23° C) and Freiburg (13° C). Only a few other studies concerning human thermal perception (thermal comfort) suggested that Swedes and Japanese might have evolved different culture-related subjective scales, accounting for the different assessments of thermal comfort between the members of the two cultures (Park et al., 2011). Also, (Igor Knez & Thorsson, 2006) outlined the differences in place-related identity versus environmental components. Due to this, the enunciatory part of long-term memory contains different organizing structures, implicitly influencing the processes of perceptions and comprehensions. Due to this, it is hypothesized that spatial perceptions are mental attitudes and a reasoning that has strong relational connections with the environmental assessments.

In summary, many outdoor open spaces, despite lacking in thermal comfort, are known to have attracted a large number of users for social activities. The relationship between the two concepts of actual thermal comfort and sense of place is vital for successfully functioning outdoor open spaces. Particularly in the context of hot, arid, and densely populated urban cities, the results of this study will be unique, novel, contributory and significantly useful to landscape architects, architects, and urban designers.

1.1 Objectives

In view of the significant knowledge gap comparing thermal comfort (science) and human factor (social science), the primary objective of this conceptual model is to decipher the influence of both weather parameters and personal human factors on participants' emotional estimations of the urban open spaces. Therefore, this model is aimed at side-by-side holistic comparisons of the direct and indirect factors impacting the users of outdoor open urban places. The model will be tested by an empirical study performed in the Walled City of Lahore, Pakistan.

2.0 METHODS

2.1. Conceptual Model

As can be seen in Fig. 1, a conceptual model comprises direct and indirect indicators of influence of place-related parameters on human responses. This conceptualization involves three main organizing entities, namely place (physical design) and science (weather parameters) vs. social science (human perceptions and responses) and by that this model will test some of the hypotheses as assumed.

This study is mainly based on interviews/surveys with the visitors to four different quarters, locally known as 'Mohallas', about their long-term thermal comfort experience and spatial perception, in the city of Lahore, Pakistan, 31.5204° N, 74.3587° E. These four Mohallas namely 'Shahi Mohalla', 'Jogi Mohalla', 'Noor Mohalla' and 'Daran Mohalla' are among the many comprising the Inner Walled City of Lahore, Pakistan. Besides interviews, a parallel weather parameter (microclimatic components) that influences human thermal comfort and sensation will also be measured. The field work will be performed for five days at each Mohalla, stretching to total of 20 days covering data collection on all four Mohallas.

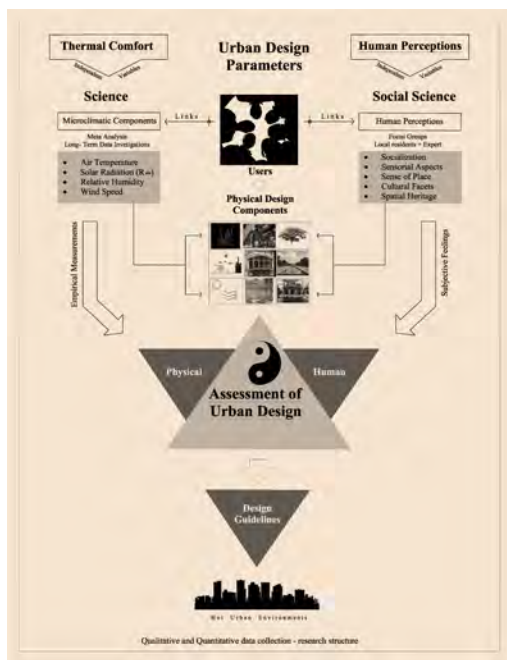

Figure 1: Proposed Conceptual Model: Holistic framework linking thermal comfort, human perceptions, and urban design parameters

The four Mohallas do not differ much concerning their fitness for the shorter and especially the evening sojourns. This fitness can be expressed by no supporting environment of 'sitability'. In all four Mohallas, outdoor cafés where people can sit and enjoy leisure time are nonexistent. The local public, in the absence of any benches, generally use flights of stairs in front of their houses to settle and relax during the evenings. The Mohallas are similar in spatial structure and other parameters that might have a uniform influence on human thermal comfort experiences. For example, they are similar in terms of urban geometry, building typologies, and density. The proportions of typical streets inside the Mohallas are often expressed in terms of the height/width ratio (H/W). This ratio sets the height of the surrounding buildings in relation to the width of the street (the surrounding buildings measured from wall to wall). The lower the H/W value of a street, the wider its proportions (Lenzholzer & Van Der Wulp, 2010), hence the inherent H/W ratio of street network inside the selected four Mohallas of Shahi, Jogi, Noor and Daran may be classified as narrower.

2.2. Assessing Place Over Space

Space and place together define the nature of an outdoor open environment. However, this study will focus more on place instead of space (Blaisson & Hess, 2016). Spatial analysis investigates physical dimensions which are of form (structure, openness), material (surface characteristics), naturalness (degree of artificiality), and location (space dimension). Weather parameters include meteorological components such as temperature (air and surface), radiation (direct and reflected long-wave and short-wave), wind speed, humidity, and overall day condition (cloudy-clear sky etc). The function of an outdoor open space may be further divided into physical activity (standing, sitting, lying, walking, running, etc.) and social activity (talking, playing, associating, etc.). In summary, space will entail and be limited to the only physical and spatial connotations (Igor Knez et al., 2009). Place, on the other hand, has noticeably been underplayed and subsumed under the geographer's concept and analysis of space. Whereas phenomenologically addressing, space is equally, if not more important in the assessment of human thermal comfort and energy balance in connection with an outdoor open environment (Lemonsu et al., 2020; Unger & Matzarakis, 2006). Place is hugely grounded in the psychological and social aspects of space experience. As explained by (Koseoglu & Onder, 2011): "...generally based on transactions between space and personal emotional, cognitive experiences that a person attaches to any outdoor setting, alongside socially structured patterns that take place within the context of an outdoor setting as those actions are given significance by the culture within which they occur". Therefore, an equitable and quantifiable understanding of the human thermal discomfort emanating from socio-spatial disarrangement can only be cohesively estimated through the proposed 'relational approach' of science in the backdrop of social science (man vs. machine) as envisioned in the conceptual model (See Fig. 2).

2.3. Users, Science and Social Science

This proposed model proffers equal and concurrent interaction of place parameters, microclimatic components, and their effect on human responses in a place-human relationship. Consequently, an outdoor physical environment (Mohalla) will be treated as an independent variable to test for an interactive effect between a place variable and a personal factor (dependent variable) on a human response. On the other hand, microclimatic components (independent variables) will be measured to assess the actual human thermal comfort and energy budgeting (dependent variable). Variables that intervene between independent and dependent variables may be divided into the categories of personal human factors involving the local residents of the respective Mohallas, the socio-cultural aspects of 'Lahoris', and the geographic dimensions of the Old Walled City, Lahore, Punjab.

As can be seen in Fig. 1, this study will be informed by, a) the scientific dimensions of air temperature, solar radiation, relative humidity and wind speed, b) social science, which will include socialization, sensory effects, sense of place, cultural facts and spatial heritage and c) users' psychological parameters of knowledge/experience, attitude/expectation, belief/preference, and perceived control. Additionally, the demographic variables of age, gender, and education along with the biological base (e.g., metabolic rate—energy output needed for bodily functioning—that may be important for thermal sensation and perception/comfort), physical and social activity parameters that define the function of the place, as well as the person-related activities, and situation, which entails the length of exposure and momentary clothing are all germane to this study.

2.4. Human Response

The main assertion of the study is to balance the over-reliance on the measured microclimatic components and its projected impact on human thermal comfort. Thus, the conceptual model will aim to comparatively examine the role of physical and psychological parameters in the formulation of human perceptions and in influencing the perceived human thermal comfort in the context four different Mohallas of the Walled City of Lahore. Human responses to the environmental conditions will depend on sensation (sensory unconscious detection of environmental stimulation/information), perception (conscious interpretation and elaboration of sensory data), cognition (how we learn, remember, and think about information), emotion (states, processes, and expressions that convey qualities of affect, feeling, and mood), behaviour (activities, doings, reactions, and movements).

2.5. Spatial Perception and Variables of Legibility

Human perceptions are described as a process in which sensory input is transformed into meaningful experiences and interpretations (Barnston, 1988). Although interpretation is very important in receiving sensory input, processing it is somehow a static function. The process that constructs human perception is subjected to inner and outer influences, and, as a result, psychological perceptions are open to unique and varied human interpretations. To assess this dimension, some of the spatial variables considered are paths, edges, districts and landmarks, for example Lynch (1960) establishes, (see Fig. 2).





Factors affecting human/users perceptions					
	Mosques, Gates, Havelis Mandis/Markets, Baghs	Bazaar, Galiyaan, Path network, Royal tails, Canals to Chaukandis	Mohalla Centre/Chowk, outdoor open squares.	Walls in and around The Walled City Lahore, Edges of water canals.	District
Visual effect	Node and Sign	Path	Node and Sign	Edge	District
Example	Hazoori Bagh of Badshahi mosque, Delhi gate, Azam cloth market, Ainak Bazaar, Waan Market, Akbari Mandi etc.	Bazaars and Galis, such as in the Mohallas of the Walled City of Lahore.	Kamran key Baradari, Baradari at Jehangir's tomb Hiran Minar, Sheikhpura. Garden of Lahore Fort	Lahore Canal, Ring road Lahore River embankment e.g. Band Road Lahore	Gulberg, Lahore Anarkali, Lahore Lower Mall, Lahore Shadbagh, Lahore
Image					
	Front Courtyard, Masjid Wazir Khan, Lahore.	Tourist Trails, TWCL.	Pavilion at Hazoori Bagh Lahore Fort, Lahore.	Masti Darwaza Lahore Fort, Lahore.	Typical Mohalla The Wall City, Lahore

Figure 2: Element of Image: Paths, Edges, Districts, Nodes and Landmarks.

2.6. Study Area, Climate, and Participants

Lahore is the capital of the Pakistani province of Punjab and is the second largest city with a population of 13 million people (Pakistan Bureau of Statistics, 2021). According to Köppen climate classification, Lahore has a semi-arid climate of Bsh. The hottest month is June when average highs routinely exceed 40 °C. The city's highest recorded temperature 55 °C under direct sun light in June 2007.

A total of 400 people (100 from each Mohalla), and users of the outdoor urban places (a chowk, a square, a courtyard, and bazaars) located within the Mohallas will participate in this study. The respondents will all be above the age of 21, and the study will engage with residents of the Mohallas only.

2.7. Micrometeorological Measurements

There are several energy budgeting models available to assess human thermal comfort (Epstein & Moran, 2006). This study will be informed by the relative magnitude of the streams of energy to and from the human body in interaction with their surrounding outdoor environments. Outputs from the model will result in designing guidelines in consideration to main energy flows and their impact on human movements in outdoor environment.

To answer the research questions, this study will utilize the human thermal comfort model COMFA to measure high-density site-specific microclimatic parameters as recorded at the local weather station. Furthermore, a wide range of data input and comparative analysis required in this study will mainly benefit from the following equation used in COMFA (Mazhar, Brown, Kenny, & Lenzholzer, 2015):

$$\text{Energy Budget (EB-W}^{\text{m}^{-2}}) = M + R_{\text{abs}} - C_{\text{conv}} - E_{\text{vap}} - TR_{\text{emitted}}$$

M= Metabolic energy

R_{abs} = Absorbed solar and terrestrial radiation

C_{conv} = Sensible heat lost or gained through convection

E_{vap} = Evaporative heat loss

TR_{emitted} = Emitted terrestrial radiation.

The data from the microclimate measurements will be evaluated for all the Mohallas. The data that is to be used will be recorded by the local weather stations once every five minutes and averaged over each hour. All microclimatic measurements will be used to plot the human energy budgeting diagrams. The only challenge in this regard is that Lahore city does not record solar radiation data and thus would not be verifiable. However, given the generally cloud-free skies during the spring and hot summer seasons, the data readings are estimated to be highly accurate.

2.8. Investigating Psychological Components

Structured survey questions will be carried out on each Mohalla. This instrument will be comprised of questions about demographic variables, general and specific questions about current weather and place, and behaviors and attitudes related to the place and person (I Knez & Thorsson, 2006, 2008). All questions from the questionnaire will be analyzed in the present study (see below). They are estimations of perceptual and emotional dimensions of weather and place, and of the urban versus open-air attitude in participants:

1. How do you perceive the current thermal condition today? (perception: perceived weather). Participants will be asked to answer this question by responding to three 5-point scales: (1) Hot–Warm; (2) Slightly warm; (3) Neutral (4) Slightly cool and (5) Cold (Lenzholzer, Klemm, & Vasilikou, 2013).

2. How do you perceive the place right now? (perception: perceived place). Participants will be asked to answer this question by responding to four 5-point scales: (1) ugly– beautiful; (2) unpleasant–pleasant; (3) windy–calm; and (4) cold–warm (Thorsson et al., 2004).
3. How do you visualize this outdoor space right now? (emotional and thermal perception). Participants will be asked to answer this question by responding to four 5-point scales: (1) elated–bored; (2) glad–gloomy; (3) calm–nervous; and (4) active–passive. These scales were derived from (Igor Knez & Hygge, 2001). Participants were also asked to estimate their thermal comfort by responding to a 9-point scale; from very cold to very hot with the score 5 as comfortable (Fazia Ali-Toudert¹, Moussadek Djenane, Rafik Bensalem³, n.d.).

2.9. Users' Perceptions: Aesthetics, Evening Get-Together, and Features of Design:

Participants' responses based on a 6-point scale will be recorded: (1) Very satisfied; (2) Satisfied; (3) Rather satisfied; (4) Less satisfied; (5) Non satisfied; (6) Not in the least satisfied. "How much of a Mohalla user (find pleasure in the street-life around corner cafes, bazaars, the amusement derived from the local culture of the walled city) (Igor Knez, 2005b).

3.0 ANTICIPATED RESULTS

The residents' responses will be used to carry out the comparative investigation of the estimated perception of the current weather conditions. Their estimation will be independent of the measured microclimatic parameters. For a robust framework of findings, any effects of age and gender on outdoor attitude and expectation will also be recorded. In summary, results will show the relational connection between how the current weather was estimated/perceived against the level of outdoor activity taking place. The findings will be used as a measure of high medium and low-level connection between actual and perceived perceptions on human behaviour and movement patterns. Participant's perceptions will be plotted according to the respondents' gender and age, as the weather and physical design features' assessment is generally influenced by their ability to withstand outdoor conditions, hence will present a broader range of responses. The age of and the environmental attitude in participants is also expected to have influence on the current weather assessments. Finally, residents from each Mohalla, will be asked to share how sensitive they felt to wind speed variations and sun during different seasons. Thus, according to the results obtained, the participants' perception of the outdoor urban places as pleasant to not-in-the-least-pleasant will be analyzed against the measured weather parameters.

4.0 DISCUSSION

The aim of this article is to highlight the psychological (individual) mechanisms involved in outdoor places and weather assessments to broaden the previous work on thermal comfort indices as well as to the body of research addressing the significance of weather parameters for the use and design of urban places. This will be done by clarifying the human information processing and how mental representation such as long-term cultural connections, stored in long-term memory, might influence place-related responses. This concept is rationalized in a conceptual model, tentatively proposing "Science" and "Social Science" links having an influence in a place–human relationship, which will be subsequently tested by an empirical study inside the four Mohallas of the Walled City of Lahore, Pakistan. The aim is to inform the impact of weather (space) and personal factors (place) on perceptual and emotional estimations (human response) of outdoor urban places.

Concerning the "independent variable" of microclimatic components (see Fig. 1), the participants are expected to perceive the weather as best they feel, largely based on the sensory feelings when the air temperature was high/low, sun/shade, and the overall day conditions of whether depending on if it was a clear or cloudy sky. It is known that air temperature and cloudlessness influence environmental assessment and activity as demonstrated by (Igor Knez et al., 2009; Nikolopoulou & Lykoudis, 2006b; Nikolopoulou & Steemers, 2003). Furthermore, concerning the place-related emotions and spatial psychology, participants of the Mohallas are apparently most glad and have historically been more active during the afternoon hours when the sun has set. Most outdoor spaces see more engagement in outdoor activities when it is cloudy. On the other hand, they are empirically least glad during the noon hours when the sun is high, and sky is clearer. This hypothetically indicates a relation between emotions and high temperature and cloudy/clear sky conditions. which is, generally, in line with (Cunningham, 1979) showing that sunlight might lead to a positive mood.

Concerning "dependent variables" of human perception (see Fig. 1), and in line with Knez and Thorsson (2006, 2008), where no effects of gender were shown to have any significant influence on participants' attitude expectation, age variable will be examined more closely than the gender. Independently of the weather conditions, the residents of the Mohallas are empirically known to have estimated the current weather less warm than it actually is. They are known to be more sensitive to the wind speed variations due to narrower and taller streets. Furthermore, regarding the participants' age, it was shown that the younger participants compared to the middle-aged and older participants generally perceive the current weather as comfortable. This is in line with Lawton et al. (1982); it is suggested that age might also be an important/personal factor in environmental assessment.

3.0 CONCLUSIONS

Outdoor spaces consist of a complex mosaic of different elements of design that may broadly be categorized into natural and built. Taken together and in line with the hypothesis, the aim of this research is to find significant influences of weather parameters comprising air temperature, solar radiation, humidity, wind speed, spatial psychology, and age on the participants' perceptual and emotional estimations of the outdoor urban places. This study is the first of its kind in the context of Lahore and is a highly significant step towards the understanding of the psychology of outdoor open urban places and weather assessments. This will add to the future studies and understanding on the human thermal comfort and energy budgeting meant for the successful functioning, use and design of urban places that is ought to be considered. Finally, it is pertinent to underline that the suggested model is a conceptual one, meaning that the model, in its present form, is contingent upon its performance.

In conclusion, the scope of this study is innovative, distinctive, and unprecedented in the context of hot climate cities. As a result, it presents a significant and contributory step towards a greater understanding of the psychological dimension influencing weather assessment and, consequently, human behaviour in the urban environment, projecting implications on urban design.

REFERENCES

- Barnston, A. G. (1988). The effect of weather on mood, productivity, and frequency of emotional crisis in a temperate continental climate. *Int J Biometeorol*, 32(2), 134–143.
- Bekele, S. A., Jones, I., & Rajamani, G. K. (2008). *Microclimate Study of a City in Hot and Humid Climate*.
- Blaison, C., & Hess, U. (2016). Affective judgment in spatial context: How places derive affective meaning from the surroundings. *Journal of Environmental Psychology*, 47(1), 53–65.
- Coccolo, S., Kämpf, J., Scartezzini, J.-L., & Pearlmutter, D. (2016a). *Outdoor human comfort and thermal stress: A comprehensive review on models and standards*.
- Cunningham, M. R. (1979). Weather, Mood, and Helping Behavior: Quasi Experiments With the Sunshine Samaritan. In *Journal of Personality and Social Psychology* (Vol. 37).
- Eliasson, I., Knez, I., Westerberg, U., Thorsson, S., & Lindberg, F. (2007). Climate and behaviour in a Nordic city. *Landscape and Urban Planning*, 82(1), 72–84.
- Epstein, Y., & Moran, D. S. (2006). Thermal Comfort and the Heat Stress Indices. In *Industrial Health* (Vol. 44).
- Eysenck, M. W., & Keane, M. T. (2020). Cognitive Psychology: A Student's Handbook. *Cognitive Psychology*. <https://doi.org/10.4324/9781351058513>
- Ali-Toudert, Fazia, et al.(n.d.). *Outdoor thermal comfort in the old desert city of Beni-Isguen, Algeria*. Retrieved from www.int-res.com
- Givoni, B. (1998). Effectiveness of mass and night ventilation in lowering the indoor daytime temperatures. Part I: 1993 experimental periods. *Energy and Buildings*, 28, 25–32.
- Graham, D. A., Vanos, J. K., Kenny, N. A., & Brown, R. D. (2017). Modeling the effects of urban design on emergency medical response calls during extreme heat events in Toronto, Canada. *International Journal of Environmental Research and Public Health*, 14(7).
- Hoppe, P. (2002). Different aspects of assessing indoor and outdoor thermal comfort. *Energy and Building*, (34), 661–665.
- Hoppe, P. R., & Seidl, H. A. (1991). meteorology Problems in the assessment of the bioclimate for vacationists at the seaside. *Int J Biometeorol*, 35, 107–110.
- Jendritzky, G., De Dear, R., & Havenith, G. (2012). UTCI-Why another thermal index? *Int. J. Biometeorol*, 56, 421–428. <https://doi.org/10.1007/s00484-011-0513-7>
- Kántor, N., Unger, J., & Gulyás, Á. (2012). Subjective estimations of thermal environment in recreational urban spaces—Part 2: international comparison. *International Journal of Biometeorology*, 56(1), 1089–1101.
- Kitchin, R. M. (1994). Cognitive Maps: What are they and why study them? *Journal of Environmental Psychology*, 14(1), 1–19.
- Knez, I., & Thorsson, S. (2006). Influences of culture and environmental attitude on thermal, emotional and perceptual evaluations of a public square. *Int J Biometeorol*, 50, 258–268.
- Knez, I., & Thorsson, S. (2008). Thermal, emotional and perceptual evaluations of a park: Cross-cultural and environmental attitude comparisons. *Building and Environment*, 43(9), 1483–1490.
- Knez, I.(2005). Attachment and identity as related to a place and its perceived climate. *Journal of Environmental Psychology*, 25, 207–218.
- Knez, I., & Hygge, S. (2001). The circumplex structure of affect: A Swedish version. *Scandinavian Journal of Psychology*, 42(5), 389–398. <https://doi.org/10.1111/1467-9450.00251>
- Knez, I., Thorsson, S., Eliasson, I., & Lindberg, F. (2009). Psychological mechanisms in outdoor place and weather assessment: towards a conceptual model. *Int. J Biometeorology*, 53, 101–111.
- Koseoglu, E., & Onder, D. E. (2011). Subjective and objective dimensions of spatial legibility. *Procedia - Social and Behavioral Sciences*, 30(1), 1191–1195.

- Lemonsu, A., Amossé, A., Chouillou, D., Gaudio, N., Haouès-Jouve, S., Hidalgo, J., ... Tudoux, B. (2020). Comparison of microclimate measurements and perceptions as part of a global evaluation of environmental quality at neighbourhood scale. *International Journal of Biometeorology*, 64(2), 265–276.
- Lenzholzer, S. (2010). Engrained experience—a comparison of microclimate perception schemata and microclimate measurements in Dutch urban squares. *International Journal of Biometeorology*, 54(2), 141–150.
- Lenzholzer, S. (2012). Research and design for thermal comfort in Dutch urban squares. *Resources, Conservation and Recycling*, 64, 39–48.
- Lenzholzer, S., & Brown, R. D. (2013). Climate-responsive landscape architecture design education. *Journal of Cleaner Production*, 61(2), 89–99.
- Lenzholzer, S., Klemm, W., & Vasilikou, C. (2013). Qualitative methods to explore thermo-spatial perception in outdoor urban spaces. *Urban Climate*, 23(1), 231–249.
- Lenzholzer, S., & Van Der Wulp, N. Y. (2010). Thermal Experience and Perception of the Built Environment in Dutch Urban Squares. *Journal of Urban Design*, 15(3), 375–401.
- Mazhar, N., Brown, R. D., Kenny, N., & Lenzholzer, S. (2015). Thermal comfort of outdoor spaces in Lahore, Pakistan: Lessons for bioclimatic urban design in the context of global climate change. *Landscape and Urban Planning*, 138(1), 110–117.
- Nikolopoulou, M., Baker, N., & Steemers, K. (2001). Thermal comfort in outdoor urban spaces: understanding the human parameter. *Solar Energy*, 70(3), 227–235.
- Nikolopoulou, M., & Lykoudis, S. (2006a). Thermal comfort in outdoor urban spaces: Analysis across different European countries. *Building and Environment*, 41(1), 1455–1470.
- Nikolopoulou, M., & Lykoudis, S. (2006b). Thermal comfort in outdoor urban spaces: Analysis across different European countries. *Building and Environment*, 41(11), 1455–1470. <https://doi.org/10.1016/J.BUILDENV.2005.05.031>
- Nikolopoulou, M., & Steemers, K. (2003). Thermal comfort and psychological adaptation as a guide for designing urban spaces. *Energy and Building*, 35(1), 95–101.
- Park, B.J., Furuya, K., Kasetani, T., Takayama, N., Kagawa, T., & Miyazaki, Y. (2011). Relationship between psychological responses and physical environments in forest settings. *Landscape and Urban Planning*, 102, 24–32.
- Thorsson, S., Lindqvist, M., & Lindqvist, S. (2004). Thermal bioclimatic conditions and patterns of behaviour in an urban park in Göteborg, Sweden. *Int J Biometeorol*, 48(1), 149–156.
- Unger, J., & Matzarakis, A. (2006). Assessment of the microclimatic and human comfort conditions in a complex urban environment: Modelling and measurements gnes Gulya. *Building and Environment*, 41(1), 1713–1722.

Exploring the Walkability in a Hospital-Anchored Neighborhood: A Case Study of Emory University Hospital Midtown Campus

Xiaowei Li¹, Dina Battisto¹

¹Clemson University, Clemson, SC

ABSTRACT: The field of healthcare design is embracing the concept of healthy communities as a model for planning and designing a hospital that are anchored to a neighborhood. A hospital-anchored neighborhood is defined as a neighborhood that physically surrounds a hospital campus with blurred boundaries between the two. The primary mechanism for connecting a hospital campus to its adjacent neighborhood is the street. The urban design qualities of streets contribute to walkability by accommodating a comfortable and safe walking environment, supporting active street life with diverse programs, and providing a pleasant outdoor experience. Walkability is a concept in urban planning for creating healthy, vibrant, and livable communities, yet rarely applied to healthcare facilities. Therefore, the purpose of this study is to explore the relationship between street design qualities of a hospital-anchored neighborhood and walkability through a newly proposed Street-Level Walkability Framework (Walkability Framework). The Walkability Framework includes seven street-level dimensions including compactness, mixed-use, imageability, human scale, enclosure, transparency, and complexity. A qualitative case study approach is used to explore the walkability patterns of the Emory University Hospital and the surrounding neighborhood in Midtown, Atlanta. The study employs ethnographic observations to generate behavioral maps that pinpoint pedestrians' locations and street use behaviors from photographs of streets during the morning, noon, and evening hours. Street design characteristics, collected from GIS archival data, Google views, and field photos and compared for the two most busy street segments and the two least busy street segments. The pedestrians' walking experience is collected from 40 semi-structured interviews with people familiar with the neighborhood. The Walkability Framework informed the ranking of the 34 street segments of the Emory University Hospital and surrounding neighborhood based on street use behavior levels. The analysis revealed a segment of Peachtree Street Northeast had the highest number of pedestrian present, while a segment of Ted Turner Drive Southwest and a segment of Spring Street Northwest next to the highway had the least number of pedestrians present. Five hot spots on the streets were identified from an analysis of street activities, and thematic patterns are discussed from the pedestrians' experience gleaned from interviews. Findings from this pilot offered some revisions to the Walkability Framework.

KEYWORDS: hospital-anchored neighborhood, walkability, street design, street behavior, pedestrian experience

INTRODUCTION

Hospitals have been anchor intuitions to adjacent neighborhoods as they contribute to both economic growth for the communities and population health (Franz et al. 2019). As civic institutions, hospitals have longstanding ties to their communities dedicated to caring for the sick and promoting the welfare of people. The disciplinary and spatial dichotomy of hospitals changed following World War II when hospitals became more fortress-like and separated from their surrounding context by roadways. Once spatially connected and integrated with neighborhoods, post World War II medical institutions were fortress-like complexes housing technologies and professional clinicians to treat ill patients. The importance of the spatial design of hospital campuses in improving the health of the neighborhood has been underestimated due to contemporary urban planning practices after World War II. Hospital-anchored neighborhood is a contemporary term to imply that the hospital and neighborhood are more intricately woven to promoting community health, wellness and foster healing environments. Walkability is a concept that can help restore this connection and cohesion across different functions that are defined by place.

Following this broader perspective, healthcare systems are embracing the concept of healthy communities to create hospital-anchored neighborhoods and pedestrian-friendly environments that incorporate a mix of medical and wellness programs. Hospital-anchored neighborhoods have difficulties in providing walkable environments due to contemporary auto-centric developments. Healthcare campuses are isolated from surrounding communities, and their streets often do not connect to the urban fabric and pedestrian patterns of neighborhoods. Post-World War II Hospitals often lack the essential urban design principles such as a fine-grid street network, mixed-uses, stacked parking, attractive public spaces, and landscape elements. In part, large-scale medical campuses do not prioritize sidewalks, green spaces, active first-floor uses, pedestrian-friendly streets with pleasant views, people, and the presence of vibrant life on the street. These are all ingredients for thriving Hospital-Anchored Neighborhoods with active pedestrian streets.

Walkability is one spatial measure that can contribute to both the physical and mental health of patients, staff and local residents. Walkability is a key indicator of vibrant, healthy, and livable streets and public spaces across various types of development. It is a concept used to understand if the design of a street is pedestrian-friendly, accommodates pedestrian comfort and safety, provides a positive experience or place for respite, and allows people to exercise. Public spaces on streets are influenced by many physical environmental features such as buildings, landscape elements, sidewalks, paving materials, trees, streetlights, bike lanes and curbs. Another factor that contributes to walkability is the uses that take place in public spaces on streets such as walking on sidewalks, outdoor cafes, seating areas, vending, street festivals, and more (Funk 2014). Studies have shown that public spaces that score high in walkability contribute to higher levels of social interaction, an increase in physical behavior, stimulate economic development, and promote a sense of community (Braun and Read 2015). This study explores the walkability of streets in one urban hospital-anchored neighborhood: Emory University Hospital at Midtown.

1.0 FRAMEWORK

1.1. Neighborhood-level Walkability

The National Walkability Index (US EPA 2014) is one of the current methods that uses GIS data to score the walkability of neighborhoods. However, a limitation of the Walkability Index is that it addresses the neighborhood scale only and does not include street-level visual differences. To assess walkability, this study identifies a 10-minute walking radius around Emory University Hospital Midtown. It documents four neighborhood-level design characteristics and walkability using the existing Neighborhood-level Design Walkability Framework proposed by the EPA (US EPA 2014).



Figure 1: Neighborhood-level Design Walkability Framework by EPA.



Figure 2: Design Characteristics and Walkability Score.

Table 1: Design Characteristics and Walkability Score by EPA.

Case	Design Characteristics	EPA Operationalized Variables	Weighted Value	Final Score
Case	Density (Building)	Building Density	0.25	15.99
	Diversity (Building-use)	Mix Entropy	1.33	
	Design	Transit Stops Density	0.24	
	Distance to Transit	Transit Stops Density	0.22	
	National Walkability Index by EPA	Weighted based on area	15.99	

The building density is derived from the square footage of building areas (lilac color in Figure 2) divided by the square footage of the area. Diversity (Land-use of Buildings) is calculated by types of land-use within an area. The land-use categories measured are residential, commercial, and mixed-use (mixed-use for land-use type, not mixed-use building), open space, residential, and transportation utilities. The diversity uses the mix entropy to represent mixed levels of building uses in an area. Building uses are determined by the use of land-use parcels. Design (Intersection Density) uses the number of intersection points from the previous network analysis divided by the area acreage. Distance to

Transit (Transit Stops Density) uses the number of transit stops within the study regions divided by the area acreage. The walkability score is calculated by the sum-up of the weighted National Walkability Index of each census block in the studied region (US EPA 2014). The classification range of walkability is from 1 (least walkable) – 20 (most walkable). The score generated from the analysis is 15.99, which indicates this medical district is walkable.

Consequently, there are significant variations in the walkability of streets in a neighborhood. To assess a more comprehensive and detailed street-level walkability assessment, studies have incorporated various methods including audits, instruments, survey questionnaires, checklists, scales, etc. (Clifton, Livi Smith, and Rodriguez 2007; Maghelal and Capp 2010). Most studies investigate several street characteristics individually rather than a comprehensive list of street features framed by urban design features. Among the studies that investigated design features, only a few have been empirically analyzed for their association with walking, and none focus on urban hospital-anchored neighborhoods.

1.2. Street-level Walkability

This paper builds upon existing studies and aims to address gaps in the literature by connecting planning, landscape design, architecture, and public health to create and pre-test a Street-level Design Walkability Framework for urban hospitals within neighborhoods. This new Framework intends to complement the EPA's Neighborhood-level Walkability Index. The Street-Level Walkability Framework expands on Ewing and Clemente's (2013) "five intangible dimensions" of urban design that contribute to walkability and livable streets. Two more intangible dimensions related to walkability, informed from the literature, are added to the five to create a total of seven street design dimensions (Harvey 2014; Mahdzar 2008). The seven street design dimensions are Compactness, Mixed-use, Imageability, Enclosure, Human Scale, Transparency, and Complexity (Figure 3). In this study, street-level walkability will be studied by assessing pedestrians' walking experience through interviews and street use behaviors through observations.

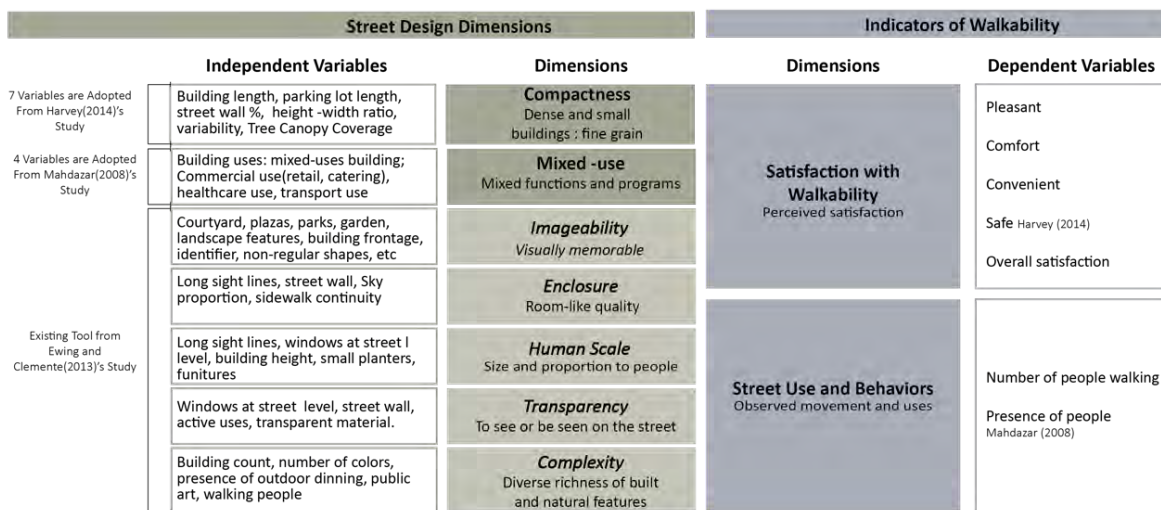

Figure 3: Proposed Complimentary Street and Neighborhood-level Design Walkability Framework.

2.0 METHODOLOGY

2.1. Research Questions and Objectives

This study serves as a pilot study for a doctoral dissertation study to test the framework, methods, data collection and analysis tools. The research objectives of this study are three-fold: (1) To develop and operationalize a Street-level Walkability Framework to systematically document street design features related to walkability in urban hospitals within neighborhoods (Ewing & Clemente, 2013). (2) To explore walkability patterns in a hospital-anchored neighborhood through studying the types of behaviors that occur on streets, how pedestrians use the streets, and how they experience walking in the neighborhood. (3) To present some modest design recommendations for creating walkable streets in urban hospital-anchored neighborhoods based on lessons learned.

2.2. Case Study Research Approach

A qualitative case study approach is used to explore walkability patterns in one urban hospital-anchored neighborhood: Emory University Hospital at Midtown. It is a short-term acute care hospital with over 500 beds and over 700 physicians. With the high number of staff, visitors and patients, the hospital has an opportunity to connect to the neighborhood environment. Emory University Hospital Midtown campus aims to be an active urban hub connecting to the surrounding neighborhood by providing pedestrian-friendly sidewalks, active transportations, assessable retails, and programs for experiential engagement (Keenan 2019). This pilot study uses a 5-minute walking radius (walking shed) as the study region, including 34 segments with labeled ID and street names (Figure 4).

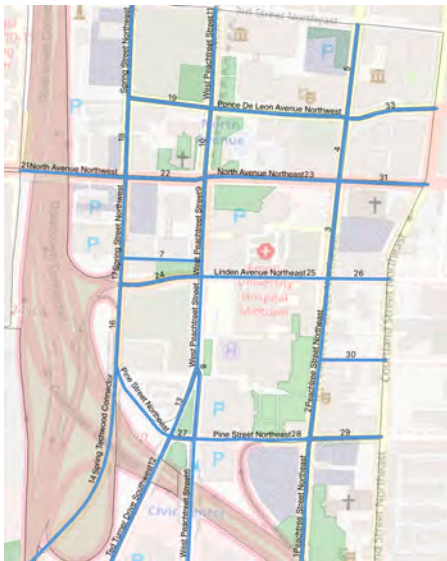

Figure 4: Case Study Scope: 34 segments of Emory University Hospital-anchored neighborhood.

2.3. Data Collection and Data Analysis

Using the Street-level Walkability Framework developed for this study, three types of data were collected and analyzed for the case:

- 1) Ethnographic observations were used to track the uses on the streets. The pedestrians' locations and behaviors were recorded three times for each of the 34 street segments while walking and taking photographs. The walk-throughs occurred in the morning from 8:00-9:00, noon from 12:00-13:00, and evening from 17:00-18:00 during one sunny weekday of October. QGIS Mapping (Space Syntax) techniques to generate the behavioral maps of pedestrians' locations and use of the street. Descriptive statistics are used to count the number of street behaviors and pedestrian on the streets. A spatial analysis was used to generate heatmaps to detect hot spots or most active areas on the streets.
- 2) The two most busy streets and the two least busy streets were selected to collect the street design features. Street design characteristics were collected from GIS archival data, Google views, and field photos. The design features for each street were mapped and operationalized using the Walkability Framework as a guiding structure.
- 3) A total of 40 semi-structured interviews were conducted with pedestrians familiar with the area. Pedestrians near the hotspots of were conveniently selected to gain insight of the pedestrian walking experiences. The semi-structured interviews were analyzed using thematic analysis to describe themes from the pedestrians' experience of walking in the neighborhood.

2.0 FINDINGS AND RESULT

3.1. Street Use Behavior Patterns from Observations

A total of 421 street use behaviors were observed from the multiple snapshots of walking on each street segment, including 328 moving behaviors and 93 pausing behaviors. There were several types of behaviors observed. Nine types of moving behaviors were sorted into the following categories: walking, jogging, shopping, walking with food, dog-walking, biking, scooter riding, using a golf cart, and using handicapped devices. Eight types of paused behaviors were sorted into the following categories: using ATM, taking photos, sitting, standing, or waiting, lying, talking, smoking, working (security or construction).

Table 2: The Street Use Pattern in a Day

Moving	walking	jogging	shopping	walking w/ food	dog-walking	biking	scooter	golfcart	handicapped	TOTAL
Morning	71	2	0	0	1	1	0	1	0	76
Noon	105	1	2	5	2	5	0	1	2	123
Evening	119	0	0	1	0	3	5	0	1	129
	295	3	2	6	3	9	5	2	3	328
Pausing	using ATM	photo	sitting	standing /waiting	lying	talking	smoking	working		
Morning	1	0	6	6	0	2	1	8		24
Noon	0	0	7	5	0	1	2	13		28
Evening	0	3	19	15	2	0	0	2		41
	1	3	32	26	2	3	3	23		93

The data collected were analyzed for hot spots using heatmaps in QGIS. The heatmap in figure 5 shows five hot spots based on the total pedestrian behaviors counted in the morning, noon and evening. The patterns vary three times a day. The movement flows happen on Peachtree Street Northeast (4. All Day- IV, V), West Peachtree Street (4. All Day- I, II, III), and North Avenue Northeast (4. All Day- I, V). The morning and evening have similar locations for hotspots, while the heatmap of noon indicates more behavior on Peachtree Street (1. Morning- III, IV, V) and less behavior on West Peachtree Street (1. Morning- III and 3. Evening- III). Most behaviors occur in the north-eastern part of the studied area. Fewer behaviors happen along highways besides Spot III.

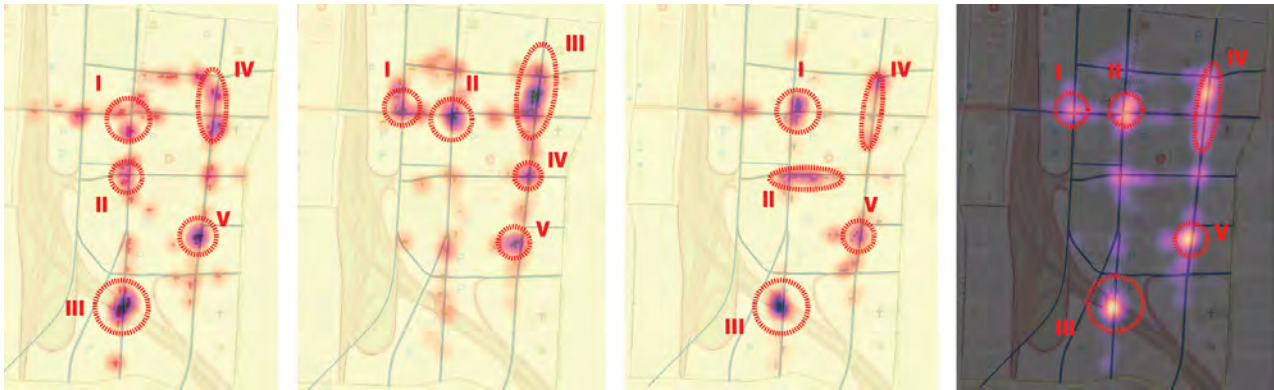

Figure 5: Heatmap and Identified Hot Spots: 1. Morning; 2. Noon; 3. Evening; 4. All Day.

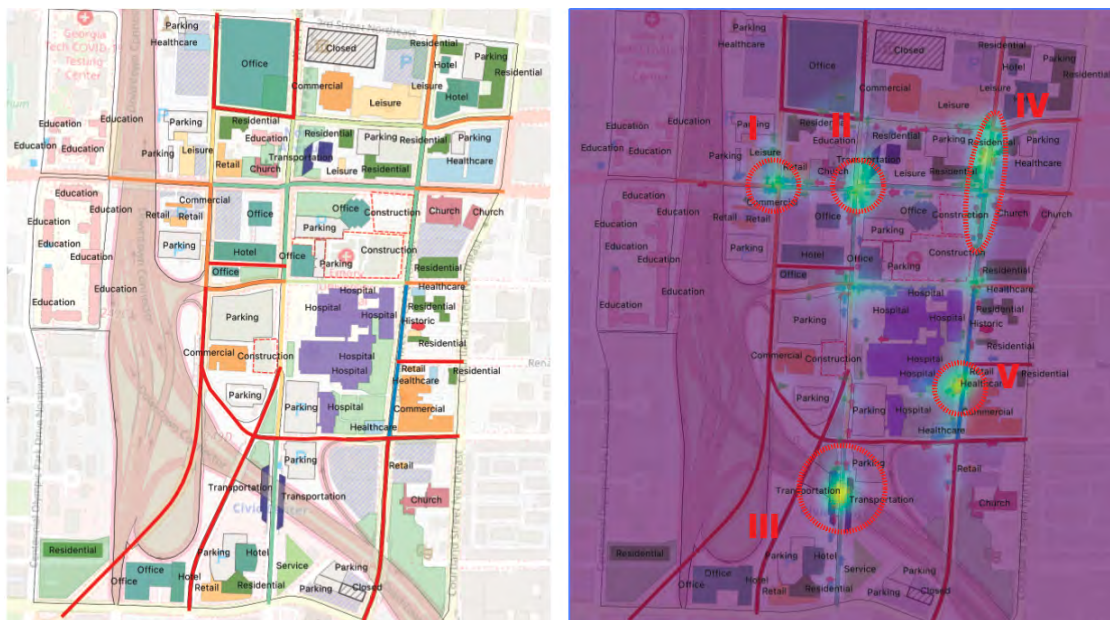

Figure 6: Hot spots in relation to Street Design Characteristics

The heatmaps are explored in the context of streets and building uses. Figure 6 indicates spot I and IV are commercial and retail uses; Spots II and III are Marta stations, and Spot V is the main entrance of Emory University Hospital.



Figure 7: Movement Flows: 1. Morning; 2. Noon; 3. Evening; 4. All Day.

Figure 7 maps out how people move, which direction they are moving, and where they pause in the morning, noon, and evening. In the morning, people move away from two separate Marta train stations (1-I and III) to move toward Georgia Tech University, Emory University Hospital, and other workplaces. Hospital staff move from the parking deck to the side entrance of the hospital. In the evening, the pattern is reversed as people move from work to transportation. During noontime, people move along Peachtree Street to get to the Fox Theatre commercial circle toward restaurants, cafes, and retails or even further north to the Midtown commercial circle for food, banking, and other leisure places. The main entrance of Emory University Hospital (4-V) is always a busy spot with people in and out, relaxing, waiting for buses, dropping off patients, etc.

3.2. Street-Level Design Characteristics of High and Low Numbers of Street Behaviors

The first map in Figure 8 indicates the rankings of 34 street segments based on the number of behaviors in each street segment. The second map in Figure 8 indicates the number of behaviors each street segment has per 300 feet since the length of the street segment varies. The results suggest that #2_Peachtree Street Northeast has the highest behavior level (54 people), and #4_Peachtree Street Northeast has the highest behavior level per 300 feet. #16_Ted Turner Drive Southwest and #12_Spring Street Northwest next to the highway have the least behavior levels.

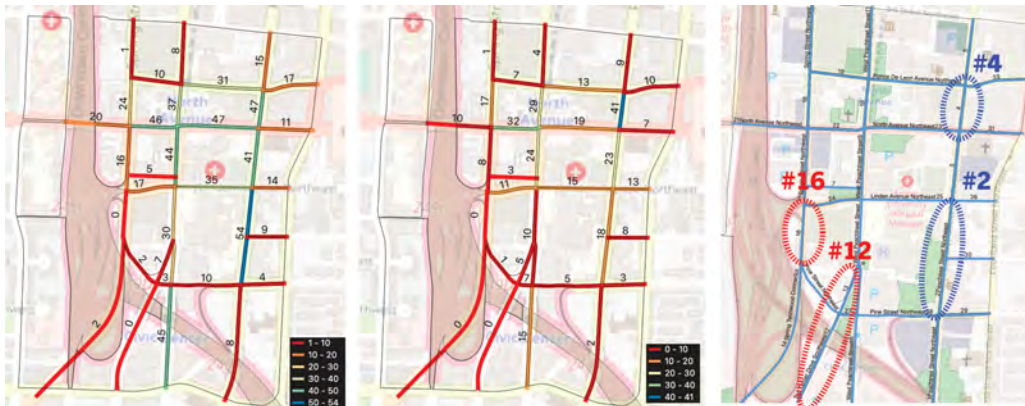

Figure 8: 1. The Number of Street Use Behaviors in total. 2. The Number of Street Use Behaviors per 300 feet. 3. Top Two Most and Least Walkable Streets.

Based on the preliminary analysis, two street segments (#2 and #4) were selected due to their high levels of street behaviors and two street segments (#16 and #12) were selected due to their low levels of street behaviors. The street design features were documented for each segment based on the criteria in the Walkability Framework and tested for the four street segments. The results show design features of streets that exhibit a high number of street behaviors have a higher value compared to the design features of streets with a low number of street behaviors.



Figure 9: 1. High No.1- ID#2_Peachtree Street Northeast; 2. High No.2 – ID#4_Peachtree Street Northeast; 3. Low No.1- ID#16_Spring Street Northwest Low No.2- ID#12_Ted Turner Drive Southwest

Table 3: Street Design Characteristics informed by Street-Level Walkability Framework.

Design Features in Dimension	High Number of Street Behaviors		Low Number of Street Behaviors	
	Street Segment #2 881 feet	Street Segment #4 347 feet	Street Segment #16 437 feet	Street Segment #12 1052 feet
A. Compactness				
A-1. buildings	10	4	2	0
A-2. street wall /300 feet	322	497	253	167
A-3. height (weighted)/ width ratio	78.96	330.0	252.01	0
A-4. tree canopy	40%	70%	40%	20%
A-5. ground parking	90 feet	154 feet	0	0
B. Mixed-use				
B-1. use types	3	4	2	2
B-1. active uses/ inactive	11	10	0	2
B-2. active entrance	13	15	0	1
C. Imageability				
C-1. garden, plazas, or parks	1 (462 feet)	2 (360 feet)	0	0
C-2. major landscape feature	0	0	0	1 (city skyline)
C-3. historic building	1 (33 feet)	2 (412 feet)	0	0

C-4. Identifiers/ signage	8 (2 signage)	10 (3 signage)	0	0
C-5. non-rectangular shape	3	5	1	0
C-6. outdoor dining	1	3	0	0
D. Enclosure				
D-1. vertical height/ sidewalk width	1.45	2.08	0	1.25
D-2. sidewalk continuity	100%	100%	100%	100%
E. Human scale				
E-1. average building height	44 feet	110 feet	102 feet	0
E-2. windows	60%	60%	50%	5%
E-3. planters or street furniture	42	26	4	6
F. Transparency				
F-1. transparent window	20%	60%	0	0
F-2. transparent fence	462 feet	210 feet	0	1500 feet
G. Complexity				
G-1. buildings colors	16	9	3	2
G-2. building materials	9	10	2	2
G-3. public art	1 (mural)	0	0	0

The results suggest some revisions for the Street-level Walkability Framework. Some street design features included in the Street-level Walkability Framework do not apply in the real context of this case (marked grey in Table 3), including C-2. major landscape feature, D-2. sidewalk continuity, E-1. average building height, and G-3. public art. These design features may not lead to differences in the behavior level of streets. B-2. active entrance (marked green in Table 3) is the design feature that was not mentioned in the Street-level Walkability Framework but was observed making a difference in the pilot study. Even though A-5. ground parking (marked yellow in Table 3) was considered a design feature that negatively influenced compactness, the street with the higher number of behaviors has a longer ground parking length. This contrast needs further explanation after studying more street segments.

3.3. Identified Themes from Semi-structured Interviews

Forty semi-structured interviews were administered at five hotspots. Thirty-four interviewees claimed they are familiar with the neighborhood and finished the whole interview. One interviewee was not familiar with the neighborhood, and five interviewees were too busy to finish. Patterns were identified from the 34 interviews, summarized in Table 4.

Table 4: Street features relate to walking experience from interview

	Good Walking Experience	Bad Walking Experience
Convenient/ Accessible (Connectivity)	crossing; sidewalk; signs; shops; foods; car-parking; people; information board; signage; shops	no point of interest; long block (street network); closed store; handicapped unfriendly
Comfortable	Seat/bench; shade; sidewalk condition, good weather; lighting; open business; "Fox theatre like"	heavy traffic; construction; scooter; litter; noise; non-stopping cars; bad smells
Safe	security guard; patrolling car; police officer; surveillance camera; lighting from stores; open business	traffic; harassment; crimes; robbery; poor lighting bridge
Pleasant/ Visually attractive	greenery; open business (shops); trees; clear sight; architecture façade; something to look at (art, flower, building); cleanliness; façade of buildings; artworks, graffiti	litter; not well maintained; bridge; blocked window
Other	friendly people, smoking places, fresh air	homeless people; stray dogs

Ten interviewees were hospital staff. The biggest issue expressed by these interviewees was the lack of points of interest, such as food, café, entertainment, recreation, green space, etc. Interviewees claimed there was "nowhere to go," "there is nothing to do," or "nowhere to walk to." Another issue is parking, with staff suggesting that there is not enough space to park. Some of them park their car at the hospital rented parking lots in the neighborhoods and needed to take shuttles or walk to the hospital. Eight of the interviewees were members of patient families. They expressed being stressed and in need of places to rest, smoke, and wait for visiting hours. Most of them describe the neighborhood as unfriendly and unsafe. The six other interviewees are visitors to the neighborhood, four residents who live in the area, and six people who work in the area. The visitors' biggest concern is safety. Many places in the neighborhood do not feel dangerous to walk. Residents prefer to have more interesting places in the area, like more food options, shopping places, recreation, and greenspaces. People who work in the area feel they are not connected to the neighborhood. They said they come in the morning and leave in the evening. Interviewees consider Peachtree Street and Ponce De Leon Avenue to be the most walkable streets. Piedmont Avenue Northeast and several places around the highway are dangerous or uncomfortable to walk (marked as red stars in figure 10). Unfortunately, Piedmont Avenue Northeast is not in the scope of the pilot study. Pedestrians noted preferred and interesting places (marked as yellow stars in figure 10), including Nail Dynasty, Bobby Dodd Stadium, Mellow Mushroom, Jimmy John's, Fox Theater, Wells Fargo, Rufus Rose House, and the Shakespeare Tavern Playhouse. Most of these places are for food or entertainment.



Figure 10: Preferred Places and Unsafe Places from Interviews.

CONCLUSION

The findings provide insights into the walkability patterns of a hospital-anchored neighborhood. The hospital is located in an urban area, at the edge of a neighborhood with convenient car access to roadways. The highway has been known to cause division in urban form patterns whereby negatively affecting the walkability of neighborhoods (Knorr 2016). The expectation was that the large-scale hospital would be the reason that there was poor walkability in the neighborhood. The results show, however, that the hospital itself has the potential to increase street use behaviors and walking experiences for pedestrians.

There are several recommendations for designing and planning a hospital campus. At first, there is a need for public space that is shared with hospitals and neighborhoods to use. Urban plazas could be a planning option for designing high-level behavior public spaces. Second, hospitals could provide parking garages with active first-floor functions for high transparency. It would improve parking issues with hospitals staff, and the active first-floor uses would improve activity levels on the streets. The third suggestion is to provide diverse food options, entertainment places, and recreation or greenspaces since there is nowhere to go other than the hospital for patients and staff. Fourth, security guards and surveillance cameras are necessary to address for safety concerns of pedestrians. At last, there is a need for food distribution and shelters in the area since some of them were closed due to the COVID-19 pandemic.

This pilot study revealed some refinements to the Street-Level Walkability Framework. Some street features do not seem to relate to street behaviors but are highly mentioned in pedestrians' experiences, like tree canopy and public art. An updated framework will separate design features by behaviors and experiences. Another major lesson learned is that the 5-minute walking radius is too small for studying hospital-anchored neighborhoods. Thus, the dissertation study will expand the scope of study to 10-minute walking radius. The methodology will be used to study three cases in Atlanta in next study. Increasing the number of observations and the number of interviews will also strengthen the results. Furthermore, increasing the number of streets segments will enable a statistical analysis to compare street features of walkable streets and unwalkable streets.

REFERENCES

- Braun, Lindsay Maurer, and Anna Read. 2015. "Benefits of Street-Scale Features for Walking and Biking." American Planning Association. <https://www.planning.org/nationalcenters/health/streetscale/>.
- Clifton, Kelly J., Andréa D. Livi Smith, and Daniel Rodriguez. 2007. "The Development and Testing of an Audit for the Pedestrian Environment." *Landscape and Urban Planning* 80 (1): 95–110. <https://doi.org/10.1016/j.landurbplan.2006.06.008>.
- Ewing, Reid, and Otto Clemente. 2013. *Measuring Urban Design: Metrics for Livable Places*. Metropolitan Planning + Design. Washington, D.C: Island Press. <http://libproxy.clemson.edu/login?url=http://search.ebscohost.com/login.aspx?direct=true&scope=site&db=e000xna&AN=596192>.
- Franz, Berkeley, Daniel Skinner, Jonathan Wynn, and Kelly Kelleher. 2019. "Urban Hospitals as Anchor Institutions: Frameworks for Medical Sociology." *Socius*, January. <https://doi.org/10.1177/2378023118817981>.
- Funk, Petra, ed. 2014. *Urban Streetscape Design*. Hong Kong: Design Media Publishing Limited.
- Harvey, Chester. 2014. "Measuring Streetscape Design for Livability Using Spatial Data and Methods." University of Vermont. <https://scholarworks.uvm.edu/graddis/268>.
- Keenan, Sean Richard. 2019. "Emory's Plan to Urbanize Midtown Campus (Huh?) Entails Parking Deck Called 'Massive.'" Curbed Atlanta. April 26, 2019. <https://atlanta.curbed.com/2019/4/26/18516721/emorys-urbanize-midtown-hospital-new-parking-deck>.
- Knorr, L. 2016. "Divided Landscape: The Visual Culture of Urban Segregation." *Landscape Journal*. <https://doi.org/10.3368/lj.35.1.109>.
- Maghelal, Praveen K, and Cara Jean Capp. 2010. "Walkability: A Review of Existing Pedestrian Indices." *Journal of the Urban and Regional Information Systems Association* 23 (2).
- Mahdzar, S. S. B. S. 2008. "Sociability vs Accessibility Urban Street Life." *Doctoral Thesis, University of London*. Doctoral, University of London. <https://discovery.ucl.ac.uk/id/eprint/1444046/>.
- US EPA, OP. 2014. "Smart Location Mapping." Data and Tools. US EPA. February 27, 2014. <https://www.epa.gov/smartgrowth/smart-location-mapping>.

Through The Eyes of The Public: The Promotion of Social Rental Housing (SRH) as a Focal Point in Addressing Housing Resilience

Chika C. Daniels-Akunekwe¹, Brian R. Sinclair^{1,2}

¹University of Calgary, Calgary, CANADA

²sinclairstudio inc., Calgary, CANADA

ABSTRACT: Comparable with the word 'sustainable' in the late 1980s, over the last decade, the word *resilience* has been used extravagantly. Resilience is deployed most popularly when enquiring about the ability of a city to assume this trait but is also invoked while exploring same in communities, institutions, systems, and infrastructure. Within the latter is housing, where recurring estimations signal the need to address the enhancement of people's lives via holistic housing solutions – specifically as it pertains to social rental housing (SRH). The challenge we tackle in this paper attempts to minimize the continued loss of SRH; first by advocating the need for its relocation from city fringes to non-poor neighborhoods, and secondly, by identifying the chief causative factors of opposition within such neighborhoods and determining the viability of operational guiding principles to aid their successful integration. The research builds upon select pillars of resilience such as collaboration, flexibility/adaptability, transformability, and consolidation. Incorporating a case study methodology, with a mixed methods approach including literature review, phenomenology, and survey, our study discovered (amongst other things) that (I) utilizing the knowledge of the residents/public as a key source of information to create the guidelines is necessary to ensuring its applicability following completion, and (II) understanding existing governance structures, policymaking processes (on localization), and possible entry and impacts points to allow the smooth translation of the guidelines into policy, and integration of the guidelines to current strategies. Moving beyond critical analysis, the work culminated in the design of the guidelines which the authors anticipate will see conversion to policy, thereby improving institutional structure, capacity and performance. Further, the authors aim to enhance resource management, and build public participation, to more potently address urgent SRH issues. This study highlights the need for a more involved local government, which proves an indispensable network in building resilience in cities across Africa and beyond.

KEYWORDS: resilience, social housing, siting, maintenance, guidelines

INTRODUCTION

*"A man is not a man until he has a house of his own."
Nelson Mandela (in his book, Long Walk to Freedom)*

Jones (2017, 129) defines city resilience as the ability of cities to “manage and adapt to change, and exhibit robustness, mitigation and adjustment at all levels”. The quality of resilience in cities is identified by three keywords: absorption, recovery and preparation, and driven via four areas: its economy, society, governance and environment (OECD 2021). Within the second, the area that deals with society, there is the issue of inclusivity and cohesiveness, active networks within communities, and the citizens' overall pleasure from access to a healthy life(style); while the aspect that focuses on the environment, is seen in the provision of infrastructure to meet basic needs, and the development of coherent policy towards land use and allocation. These two areas address myriad elements, among which is the city's housing and its ability to shelter its inhabitants. In this paper, we deem housing to be foremost amongst the elements that can guarantee urban resilience, which is in alignment with Ernst & Young's (EY) argument in 2018, that any kind of urban resilience discussion should commence at home/house building.

Looking at housing through the lens of resilience implies considering at least three (of its) characteristics: supply, diversity and affordability. According to O'Toole (2017), affordability in housing which refers to the general level of housing prices relative to the general level of household or family incomes, often measured by dividing median home prices by median family incomes, is most manifested in affordable housing. Although affordable housing is an umbrella term for a large group of housing types that are

available at a cost that does not compromise a household's ability to attain other basic needs of life (AUMA 2017), the specific type that we focus on is social housing (SH), which represents secure affordable rental housing - a “category of non-market housing where the cost is subsidized by the government” (AUMA 2021) so that the housing needs of the low-income earning population can be satisfied. Amongst the myriad tenures and types of affordable housing, SH is not only named the housing of the future (Harloe, 1994; Maclennan & More, 1997), but the housing for resilience, “the

most essential component for urban resilience” (EY 2018, 5). The EY article establishes its (SH) place as a requirement for the interconnection of systems within the urban environment (2018, 5). The article refers to SH as *resilient* in its ability to provide support physically and socially to prepare for and withstand “increasingly frequent shocks and stresses of the century” (EY 2018, 8). Also, for its ability to make the most of opportunities to champion resilience in the larger community. Via EY’s (2018) extensive study, the researchers determined that there are three considerations and ten principles that essentially furnish SH with its characteristic resilience. Among these two lists is a strong reference to two elements: (I) (the quality of) the physical asset/infrastructure (8, 10), and (II) connection to the larger community in terms of suitability to the current neighborhood fabric and quality of life for the residents (8, 10). In other words, materiality but more so, the maintainability of the materials utilized, and two, siting.

The fear of increase in crime, fear of destruction of neighborhood facilities/amenities and property, fear of decrease in property value, the belief that pro-poor housing properties (such as SH) are unattractive and poorly maintained, the ideology that the poor generally have larger families with all of whom they typically move into their allocated housing (resulting in supplementary burden on amenities), and an ideological view that pro-poor housing recipients do not deserve assistance, are a few reasons why SH continues to be resisted by intending neighborhoods. In addition to the above, Pendall (1999) and Tighe (2010) discuss another factor responsible for eliciting negative perceptions and/or responses to the diverse forms of pro-poor housing, which is (related to) the disconnect between the housing design and its occupants. This is manifested in the design phase of pro-poor housing where little to no consideration for what is preferred is accorded its residents. Thus, it is common for residents who overtime find the premises and accommodation unpleasant to become dissatisfied and move away resulting in high rates of building abandonment. Also, in a bid to assume very little expenses, the bare minimum is chosen in the design and execution of pro-poor housing, which brings about unsightly buildings that has become synonymous with pro-poor housing today. These above-named reasons have recurrently been captured in the context of the developing region.

Within the same context, in a country such as Nigeria, just as the reasons for SH opposition are similar irrespective of location, so also is the case with the factors/conditions that impede its resilience. Not engaging with all (concerned) citizens, failure to consider the performance of the housing solution from multiple perspectives/sectors, failure to identify, mobilize and sustain a pro-active response team to the (most significant) risks, as well as less tangible conditions such as: non-feeling of community life, that is, connection between neighbors, sense of belonging, respect for diversity and inclusion, and neighbourhood attitudes. Two elements however, siting and maintenance, are chief among reasons why SH developments fail in terms of competence and longevity and continue to be met with resistance and therefore also failing to be preserved. If SH must be resilient, the issues that contest/combat its durability need to be tackled.

In this paper, the general idea of SH resilience will imply the following: (I) ensuring that SH developments are conserved, (II) revisiting and rethinking age-old/current SH siting and maintenance strategies, (III) guaranteeing the acceptance of such developments (specifically) within neighborhoods of opportunity (*that is*, non-poor neighborhoods). This paper will attempt to answer the following questions: (I) why resilient SH is particularly important in Nigeria, (II) what the current issues associated with SRH siting and maintenance in Nigeria are, (III) why it is necessary to both *see* and *resolve* the issues “through the eyes of the public”, and (IV) the solution to better siting and maintenance, and conservation of SH supply based on public participation. While we aim to address all the above, the primary objective of this study is to propose a viable comprehensive SRH siting and maintenance guidebook for Lagos by speaking to issues highlighted from a diverse group of participants. Using Lagos as the focal point of this intervention and exploring the potential for bottom-up community engagement in the creation of this guidebook, specifically: practitioners, planning officials, and government officials with the necessary information and evidence base to make decisions that promote viability and sustainability in the development of the document. To elicit the responses from participants that would prove instrumental to creating the proposed document, questions centered around the following will be developed: (I) how SH, in terms of the development process (from planning to occupancy), is experienced/perceived by members of non-poor neighborhoods, (II) what factors inhibit or facilitate acceptance of SH developments, and (III) what planners/governments can do to influence the experience/perception of members of non-poor neighborhoods towards SH developments. Investigating how residents of non-poor neighborhoods perceive (the idea of) SH through the development process is the underpinning of my research.

1.0 UNDERSTANDING THE ‘WHY’

Housing, irrespective of type, already plays an essential role for mankind; its “impact on the health, wealth and output of man is profound” (Ezeanah 2021, para. 1) such that without it, a person’s place in the society is uncertain. This is why affordable housing, and its variations; SH included, is critical, so that everyone, notwithstanding societal status, can have access to (and obtain) housing. Housing is not only beneficial to the overall well-being of the individual but to the nation’s health, in its ability to pull economies from depression, and serve (via housing construction and markets) as an engine of growth (Moore 2019, 22). Housing in Nigeria is fundamentally informal and therefore, precarious. There is, however, a small percentage according to Housing Finance Africa (Razwani & Nielsen 2021) that constitutes the formal housing market; at least, 80% of which is self-built and affordable only by the wealthiest 5-10% of the population – *even at its cheapest*. Housing therefore continues to elude the general populace. As a result of the unavailability of

and inaccessibility to SH, which is the specific housing type most needed, the effect that housing should have on an(y) economy is yet to be manifested in Nigeria.

1.1 The impact of a severe lack of SH on Nigerians and the Nigerian economy

Nigeria continues to suffer from a lack of SH. While the Nigerian government acknowledges that increasing housing supply and reinforcing protection policies for those with special circumstances (renters, low-income earners, disadvantaged etc.) are important, the depth of the housing challenge is one that seems to be beyond their abilities (Florida & Schneider 2018). According to Florida & Schneider (2018), it has devolved to the point that “international development organizations will need to step in to... provide the housing that is so badly needed” (para. 4).

The economic impact from the continued shortage of SH is equally dire. Economic experts acknowledge that the lack of housing is chief among the problems with the economy today. Not to mention the impact of the lack of SH in the “expensive and productive locations that drive the economy”, which they conclude is an even bigger problem (Florida & Schneider, 2019). The huge negative economic impact is both direct and indirect; direct in the way that it impacts businesses and indirect, in the way that it impacts individuals and families, and their level of productivity and thus, the economy (Florida, 2019). With regards to the former, poorer/lower-income families have less disposable income, which implies less money spent on the goods and services offered by local businesses, and therefore, no/slower business growth. Also, for businesses that rely on employing poorer/lower-income workers such as manufacturing companies, which compensate with meagre wages, inaccessibility to cheap housing is critical for the success of the business. With regards to the latter (that is, indirect negative economic impact of lack of SH), if an unskilled individual, who seeks a decent job, is unable to secure it because of unavailability of adequate and affordable housing (SH), it is equal to a substantial amount of productivity lost. Many newcomers, immigrants and refugees experience this upon arrival into a new community; a lack of housing creates barriers to allow these groups integrate and begin to add value to the economy. Fundamentally, if people are unable to secure housing, there is a level of instability that they are confronted with that impacts other facets of their lives such as: education, health, transportation cost, etc. that ultimately affects the economy (Garrison, 2014). Without sufficient (social) housing, the economic stimulation driven by boosting demand that enabled countries grow such as the US in the industrial 20th century is not attained.

1.2 Why SH is particularly important in Nigeria

The Nigerian climate is a rather unique one. This year, *Worldometer*, a population ranking website, that depends on estimates provided by the United Nations, ranked Nigeria as the 7th most populous nation, with about 206 million-plus inhabitants (Worldometer 2021). Of this population, almost 50% is poor – and this is a huge improvement from the 61% recorded in 2012 by the British Broadcasting Corporation (BBC 2012). According to the National Bureau of Statistics (NBS in Nigeria), this percentage (almost 50%) lives on USD335.19 (NGN137,430) per year. While the number, percentagewise may have declined, the poverty situation has only gotten grimmer; such that in 2018, Nigeria overtook India as the country with the largest number of people living in extreme poverty (Adebayo 2018). Now, in 2021, Nigeria is said to be the poverty capital of the world (Fry 2020; Panchal 2020).

1.3 Why the SH needed should be RESILIENT

With such a large poor population, SH needs to – in addition to being available - be resilient. Addressing resilience means that: (I) investing in this housing type becomes attractive to investors who can be guaranteed that the housing developments being financed are built to last, and (II) construction costs and consequently, rental costs, will be reduced thereby increasing accessibility and affordability of SH. Ultimately, those who are most at risk for homelessness due to their economic status, are presented an opportunity to secure accommodation, have access to the region’s amenities/services, and rise on the economic ladder within the society. This is based on Bank’s (2019) study where he states that improving resilience in SH does not impact only the housing asset, but the economic resiliency of its occupants as well.

2.0 Why siting and maintenance are focal issues + what are the current issues associated with SRH siting and maintenance in Nigeria

In terms of SH siting, studies show that over 70% of all SH units are unplanned and located in poor, and blighted fringe neighborhoods (Ajayi et al. 2014). In part, the placement of these units in such neighborhoods reflects: (I) the availability of land in these areas and therefore the ease of locating them without much thought, (II) the disregard for the outcome of the development and well-being of its occupants, (III) the disinterest of the government and planning authorities in upsetting other, more adequate neighborhoods, and (IV) the conflict concerning allocating greenfield to such land uses etc. (Keating et al. 1995, p. 230-232). Jackson et al. (1994) opines that land should very seldom be allocated because of availability but rather for more reasonable motivations such as: potential, profitability, and level of demand etc. This, however, has often proved difficult because private developers, who are very possibly the project owners, are unlikely to site SH developments on land where market appraisals indicate high demand (Carmona et al. 2003, p. 72-73).

A review of literature on SH siting reveals that initially, between the 70s and 90s, the Nigerian government built SH developments in non-poor neighborhoods (Waziri & Roosli, 2013). Examples such as: Shagari low-cost housing (built across 19 states in predominantly prime urban locations), and Jakande low-cost housing estates (over 30,000 housing units spread across both prime urban areas and urban suburbs/hinterland in Lagos) (Waziri, 2014). At the time, chief

among the factors impacting social housing siting decisions was the need to close the distance between its residents and community facilities hence more of the housing developments were constructed in neighborhoods closer to city centers (Makinde, 2014). Although, the developments in prime areas were more expensive than those farther away from city centres (Olotuah, 2000; Olotuah & Bobadoye, 2009). The 90s and the twenty-first century however, ushered in a completely different scenario. Driven by inflation, the need for less capital-intensive projects, and availability of larger parcels of land – both of which are met when building at the outskirts – the government focused most of its attention on constructing SH developments within these parts of the city (Ikejiofor, 1999; Isah, 2016). Despite the diverse adjustments and changes to the processes involved in constructing SH, the decision on where to site the development has always been political - reserved for a government official well-suited to the prominence/significance associated with the development (Isah, 2016). Literature implies that there is no slated location for siting SH on record; rather it is an economic decision because if a developer can purchase land; get approval from the responsible government authority and the support of planning officials, afford titling, registration expenses and construction costs, then the government is satisfied with the prospect of a reduction in the housing deficit.

Maintenance is not less problematic. Like land allocation and siting, the maintenance (and management) of SH was the responsibility of the government (Isah, 2016). This duty of management was executed by specific authorities selected by the government (Isah, 2016). Currently, SH in Nigeria may be owned and managed by the state, by non-profit organizations or by a combination of the two (Adejumo, 2009). Management and maintenance of SH are considered to be so burdensome that developments “are abandoned either halfway to completion, after completion, or not even embarked on as a result of there being no framework” to address both these activities/programs (Fatoye & Odusami, 2009; Fatoye, 2009 cited in Ihuah & Fortune, 2013, p. 902). Ihuah & Fortune (2013) opine that the rationale behind abandoning projects for lack of a maintenance plan is because the role of maintenance in a building spans beyond the building itself (that is, functionality, physical appearance, and economic returns/value) and its users to the built environment (p. 908). Despite the enactment of several housing policies that emphasize the need for both a planned and an unplanned maintenance policy, Nigeria’s notoriety for having a poor maintenance culture remains unchanged (Ihuah et al., 2014). As far back as in 1991, a review completed by the Federal Government indicated that the backlog of maintenance required to bring the existing units to acceptable standards was equivalent to the cost of three million new units (FRN¹, 1991). Researchers (Ozdemir, 2002; Fatoye, 2009; Ihuah & Fortune, 2013) have indicated that the lack of a maintenance culture in the Nigerian housing sector may be the sectors number one challenge. To limit the challenge of maintenance, recent policy discussion papers have suggested the transference of the responsibility of maintenance to the inhabitants of the development as part of the government’s plan for an operational subsidy (Isah, 2016).

3.0 Why it is necessary to both see and resolve these issues “through the eyes of the public”

*“Pro-poor housing is about people.”
(City of Calgary 2021)*

In exploring the resilience component that this paper addresses², a key fragment involves engaging the public towards capturing their idea of what resilience ‘looks like’ and how it can be represented with regards to siting and maintenance. The reason being that we utilize two theoretical pillars to frame the study - affordable housing theory, and social theory of housing design. The former draws attention to the relationship between features of housing and features of society (Salama, 2006; Ruonavaara, 2018) by addressing “underlying concepts including visual preferences, people satisfaction (of their current houses and residential environments), place attachment, and appropriation (this addresses the physical characteristics of a housing development, which needs to be seen from a ‘home’ perspective” (Salama, 2006, p. 72), the perspective of those who are part of the existing home environment (Salama, 2006), while social theory of housing design, which speaks to a

*“study of design based on a theory of what kind of structure is desirable in a project and how to use design to get it”
(Wood, 1961)*

The latter is almost exclusive to the exterior of the building, its grounds and the treatment of external spaces (King, 1984; Salingaros et al., 2019). Therefore, based on public perception, decisions around both siting and maintenance that are instrumental in guaranteeing the longevity, durability, and adaptability of the SH development will be compiled in a format that allows for easy operationalization. Chief among the reasons why resolving these issues through the lens of the public is essential is because: (I) research indicates that the public are more accommodating of public housing (pro-poor housing types) when they are involved with the key decisions surrounding its construction (Scally 2014), (II) without the input of the public, it is difficult to gather a comprehensive list of the elements and factors to be considered (within the boundaries of these two issues) that would be instrumental to ensuring the resilience of the SH development, and (III) in order to allow the involvement of any willing, qualified (in terms of basic criteria for participation in the study) participant, and ensure operationalizability, the individual should be able to speak to external factors [i.e. siting, building features/elements, and treatment of surrounding area (maintenance) etc.].

¹ Federal Republic of Nigeria

² Ensure conservation of SH developments, (II) revisit and rethink age-old/current SH siting and maintenance strategies, (III) guarantee the acceptance of such developments (specifically) within neighborhoods of opportunity (that is, non-poor neighborhoods).

In creating pro-poor housing policies, specifically SH policies, the starting point is typically, deciding and categorizing what issues to address and those that would be disregarded (Hansson & Lundgren, 2019). This decision is contingent on how the term is defined within the specific context. For example, in Canada and Australia, their SH policies constitute a variety of different programs, used to address a similar number of goals defined in their definitions (Cowans & MacLennan, 2008). Unlike, what typically obtains in several countries, where SH is reserved/allocated for/to the most disadvantaged in the society, in Ireland; SH is a “steppingstone to owner-occupation” (p. 66). In the Netherlands, SH is defined by rents. Because SH in the Netherlands is considered a service of general economic interest (SGEI), eligibility is bound by an annual adjustment to household income ceiling (Czischke & van Bortel, 2018). In Italy, the terms affordable housing and social housing imply the same idea, but differ from public housing, which refers to housing for low-income households (ibid.), while in Poland, according to the Rosenfeld (2015, p. 8), there is no official definition for social housing. However, the Polish housing market provides two housing types that cater to the population with income level below average (Czischke & van Bortel, 2018). Based on the definition of the term per context, policies are created. Typically, SH policy constitutes a number of elements; a system, target group, form of tenure, responsibility of provision/type of provider, subsidies, and public intervention (Hansson & Lundgren, 2019). The last element listed, which should constitute any SH policy, and is particularly important to this study, is public intervention (ibid.). Public intervention discussed here is two-sided: one refers to the role of public bodies, which typically takes three main forms: (I) regulatory, (II) subsidization, and (III) “direct provision of SH either through public bodies or publicly owned companies” (p. 161). The other side, which speaks to usefulness and operationalization of the policy, refers to building a strong, robust policy at the local level that accommodates the contribution, and consideration of the expression and participation of citizens towards decision-making. While the former is common in numerous countries; the latter, is not, including Nigeria. (For this study, we found this side to be a much more meaningful route to the sort of information we sought.) All the nation’s housing policies, SH policies included, exclude public participation, not to mention public intervention (Festus & Amos, 2015; Ochoi et al., 2015; Olawale et al., 2015). Its exclusion does not imply unimportance though because researchers, including Braga & Palvarini (2013) indicate that SH as should its policies be about the overall concern of the public. To achieve this, they suggest a responsibility by the government to include the public. The reason however, why public intervention by members of the populace has not become commonplace is because research that support its utilization and highlight its importance, are unable to demonstrate a persuasive relationship between (successful siting and maintenance programs for) SH and public contribution.

4.0 METHODOLOGY

The study utilized a mixed-methods approach to analyze the cases (SH projects) that were selected. The qualitative and quantitative methods applied are as follows: first, we reviewed the literature, then formulated and tested the research questions. The next step was exploratory and descriptive case study because there is limited existing literature about the topic under investigation in my context. This research examined the research questions from the various perspectives of the neighbourhood residents and stakeholders in selected neighborhoods in the Lagos Metropolis Area. It employed the use of an embedded case study that applied both qualitative and quantitative strategies. The qualitative methods included literature review, field/personal observation, semi-structured interviews and phenomenology, and focus group, while survey was the singular quantitative method applied.

Our study obtained descriptions of experiences of community members who witnessed specifically: (I) the discovery/observation of the decision of the government to build the SH development, (II) the identification and (final) selection of the location(s) that were considered suitable, (III) commencement of actual planning and design process (demonstrated by visitations of planning and government officials to the project site), (IV) implementation of the design of the development or commencement and completion of construction, (V) occupancy of the development, (VI) observed change to neighbourhood between existing and new communities, and (VII) the dilapidation, and consequent abandonment. Obtaining this information was helpful in discovering the unique perspectives of the members of the non-poor neighbourhood on how the process of siting SH developments can be (better) facilitated, and which elements of the development are able to deface/damage the development, its vicinity, and by extension, the larger area around the development if not maintained.

5.0 THE SOLUTION TO BETTER SITING AND MAINTENANCE, AND CONSERVATION OF SH SUPPLY BASED ON PUBLIC PARTICIPATION

4.1 The Guidelines

The results shared here were obtained from the phenomenological study by way of interviews with selected participants, who had proven to meet the criteria to qualify them as suitable sources of information for the study. The 51-member interviewee pool (as indicated above) required a group of participants that included residents of the non-poor neighborhood, planners, property developers, and government officials.

The following criteria guided participant selection for each of the groups:

- Nine government officials (stationed across four Local Government offices in Lagos) who are involved in and aware of public housing and planning history in either of the four neighborhoods where a SH development of interest to the study is located.

- Six (property) developers who have worked in or have affiliation with development companies with history of constructing low-cost housing/SH across Nigeria. Information on the development/construction companies that were responsible for the construction of the four SH projects selected was sourced from both the planning offices and local government offices charged with monitoring and supervising the activities that occur in the neighborhoods where the selected projects are located.
- Eight planners who (have worked in and/or continue to work in a Planning office located across one of the four neighborhoods) are aware of the planning and development processes involved in siting and constructing the four projects and who are currently involved in or aware of the existing situation and state of these projects as well as the on-going programs (if any) instituted towards maintenance.
- Twenty-nine residents, including both young and old, who check several boxes: (I) genuine interest in the phenomenon, (II) good grasp of the study's investigation, information that is to be collected, and objectives, [that is, (a) have witnessed the construction of and subsequent abandonment/dilapidation of the SH development, or (b) have been of an age that allowed them to be aware of the situation with the development from inception through till abandonment, (c) have been of an age that allowed them to form an opinion about the situation with the development and its impact on the neighbourhood, and (d) currently be able to communicate clear and detailed accounts of their experiences during the period of the occurrence], and (III) duration of period of residency within the neighbourhood.

The information derived centered around the participants' subjective experience; their perception and understanding of the specific issues around the two themes related to SH. Because of the sort of information sought in the study, participants were from different levels: the public, private and government levels. At the public level, residents from non-poor neighborhoods who own and live in their residential properties (and have done so for long periods) were selected for their knowledge and observation of everyday life (in and) around select SRH developments. The information at this level provides a fundamental bottom-up perspective critical to providing the best solutions tailored to context, and as earlier determined, preparing a housing policy document aimed at improving the living situation of the public requires beginning at the level of need upwards (Daniels-Akunekwe & Sinclair, 2019). A mixed methods approach was taken, which included field observation, semi-structured interviews, focus group discussions, and survey.

4.2 The Guidelines

The section details one way to address both issues collectively, that is, the creation of an operationalized siting and maintenance guidebook via a set of guidelines. While the guidelines do not tackle the provision of SH units, it aims to ensure that every unit produced is not lost but rather, is safeguarded so that waste and loss caused by poor siting decisions of the estate (resulting in vandalism and abandonment), and the effect of little to no maintenance (evident in the eventual dilapidation) is minimized or eliminated.

The document (guidelines) the author proposes is a viable comprehensive series of questions on SH siting and maintenance decisions that form a set of guidelines. The guidelines will constitute a tool to convey guiding principles and specifications for the siting and maintenance of SH. It will outline minimum standards required by the city where it is to be adopted and which can be adapted (to varying contexts) in order to address these two challenges. While it does not aim to specifically assign tasks to the different groups of government officials and (design & construction) professional that will utilize it, it will generally provide direction to housing maintenance (and management) bodies, building developers/contractors (and possibly, designers), as well as other groups involved in the process of pro-poor (and public) housing siting and maintenance.

This document both responds to and builds on complaints and suggestions received/collected over time by local government officials and field officers within the neighborhood-specific planning offices. In addition to the complaints by the population grounded in personal reasons, certain macroeconomic elements such as the rapid population growth, increasing socioeconomic income/status gap, widening supply-demand gap for pro-poor housing (particularly SH), and demographic factors, are some of the reasons why developing the guidelines remains necessary. The guidelines will constitute an important part of attending to these issues as they relate to SH.

For the guidelines to provide the anticipated benefits, particularly that of transferability so that several (if not all) cities and states in the country, which are also confronted with similar challenges, can be improved by utilizing the guidelines, the unique characteristics per city/state should be taken into consideration in order to tailor the guidelines to the context. However, in this case, the author suggests that with SRH in the country being problematic, following the utilization and implementation, and effectiveness of the guidelines in Lagos, the government should contemplate the SRH situation in other cities/states, file them accordingly, and commence adapting the guidelines so that rather than a reactive approach, an anticipatory one is taken. Also, although the communication and coordination between the different actors and resources is advocated, there is general fear evident among the general population regarding in the notorious inability of the government to administer and accomplish the intricacies of managing the various institutions, in terms of outlining responsibility, institutional mechanisms, development of new skills and capacity, and funding provision and allocation.

In terms of the specific intentions of these guidelines, they are to:

- I. constitute a portion of the nation's (current) Social Housing Bill,
- II. be applied to the construction, renovation and conversion of any pro-poor housing development either developed or secured by the government and located within non-poor neighborhoods,
- III. provide a plan for the built form, as well as its design and the requirements for all public pro-poor housing development owned by the National Government,
- IV. provide a minimum standard required by cities across the country for building elements such as: materials, finishes, and additional elements that could ensure long-term efficiency and durability, minimizing maintenance and operational costs during the lifetime/through the period of life expectancy of the building,
- V. be used as a tool by consultants in developing their strategies for taking care of public pro-poor housing estates,
- VI. ensure that the standards across all the public pro-poor housing developments in the city/country maintain consistency in the decisions and outcomes related to their siting and maintenance, and
- VII. ensure that although variation to the guidelines may be considered, they are not to proceed without prior discussion, acceptance, and approval by the cities in the country

The authors ensured that certain characteristic elements were reflected in the document such as: flexibility, adaptability, clarity and rigor. *Flexibility and adaptability* because they are key components of resilience, and as contexts and users change, and the guidelines are applied to solve these challenges across multiple scenarios, new or differing ideas/perceptions/suggestions could be introduced based on the assortment of problems that would emerge. Also, because housing is not an isolated event but rather part of a larger network of land, urban development, and works within the country.

4.3 The Siting Guidelines

The criteria established ensures that the: (I) guidelines are efficient, (II) decisions made based on the criteria will allow the site selection process progress smoothly, and (III) all decisions made can both be defended and traced so that adjustments can be made as required.

- (I) Planning the site selection process
 - a. Defining the search area
 - i. Zoning and land use
 - b. Site capacity, size of site and/or basic site adequacy
 - c. Identifying, listing and assessing potential sites
 - d. Site accessibility
- (II) PART A: Putting together the project team
 - a. Public consultation
- (III) PART B: Involvement of public community groups
- (IV) Planning approval (seeking planning approval on the siting process and criteria)

4.4 The Maintenance Guidelines

The objective is to ensure that the development continues to meet the requirements of the neighbourhood, its residents, the occupants and all other impacted parties in a more-than satisfactory manner by developing a document that is: (I) sufficiently comprehensive without being burdensome, (II) able to be updated, improved, altered, and adapted as required, (III) easy to read, understand, and allows users to locate information quickly, and (IV) clear on the roles and responsibilities of all the individuals who are expected to play a part in the implementation of the document.

- (I) Initial inspection
 - a. Identify the elements requiring maintenance
- (II) Set up a directory/catalogue
 - a. Detailed record-keeping
 - b. Setting a standard and maintaining standardization
 - c. Scheduling and regular inspection
- (III) Prioritization of items requiring maintenance
 - a. Establish and prioritize the items for maintenance.
 - b. Determine the frequency of maintenance
- (IV) Set parameters
- (V) Maintenance service planning
- (VI) Designated technicians + worker relations
- (VII) Maintenance budgeting and financial control
- (VIII) Documentation
- (IX) Modify the maintenance program

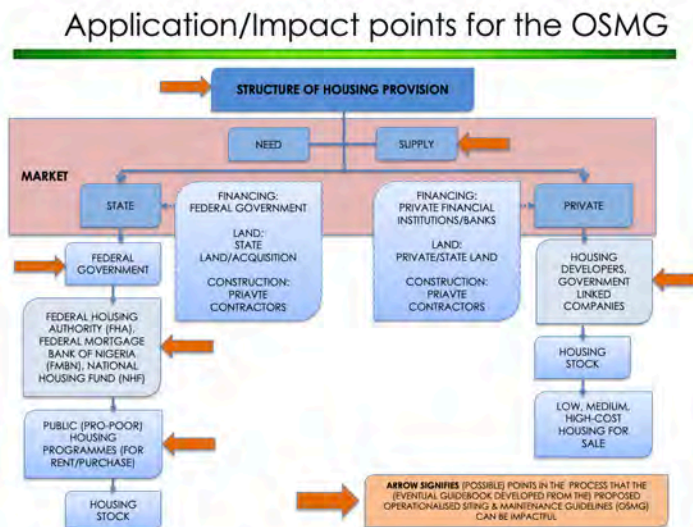

Figure 1: Diagram of the current structure for housing provision with possible application/impact points for the proposed OSMG (Daniels-Akunekwe, C. C. 2021)

CONCLUSION

The study establishes that the proposed guidelines is indeed one viable answer to resolving both siting and maintenance issues associated with SH for the following reasons: (I) because the local government, which operates at the level of implementation and operation and are unconnected and have no control over policymaking and decision-making processes, yet still applaud the efficiency and adequacy of the guidelines, (II) there may be other suggestions in terms of equally viable options, but this solution presents an opportunity to address additionally urgent and important issues under the overarching reason of improving synergies and coordination among the parties involved in both the policy-making process for housing as well as for planning generally. Despite these advantages, the study uncovered, highlighted and confirmed many factors that could hinder its smooth integration and implementation including the poor institutional structures and capacity and limited role of the local government.

Based on the robust information derived from the study, the following were determined, which were essential to conceptualizing the framework, developing the guidelines as well as adopting the structure to enable the integration of the guidelines into policy and the capacity to ensure that the support to aid implementation is instituted/established.

- By gaining information from interviewees regarding not only the neighbourhood but the larger setting, the city, it provides the platform to exploring the nationwide context and determining the applicability of the guidelines in other cities,
- Developing the guidelines provided a window into:
 - Understanding the existing governance structures, and policymaking process on localizing the guidelines. Entry and impact points in this process was also identified.
 - The current practices with planning in Nigeria, siting and maintenance strategies related to public housing/SRH. It revealed the issues, how they can be overcome, and approaches to addressing them that could advance the implementation and integration of the guidelines (as policy).
 - At the local government (area) and neighbourhood levels, practices, tools, skills, and capacity of the offices through which planning related exercises are currently executed, and the perceptions of the (non-poor) neighbourhood were explored and captured respectively.

The findings are very likely applicable to other cities that are confronted with similar issues and are seeking similar solutions. While there may be huge disparities *even* across African cities and in developing countries' cities in terms of their macroeconomics, there could be similarities that can *still* aid transferability such as government structure (top-down, rational approach), poor community involvement, socio-economic conditions, etc. Therefore, at least, while in certain scenarios, the findings here may neither be wholly nor partially transferrable, it could aid in framework conceptualization for such cities. In terms of non-African cities and in developed countries' cities, while the findings may not be directly applicable as a result of the disparities in macroeconomics and diverse other ways, the data collection strategies and framework, which are effective tools, can be transferred and applied towards necessary policymaking.

In 2016, Massengale wrote that if Jane Jacobs were still here, chief among the issues she would be championing now, is *not* just affordable housing but housing that could be substitute accommodation for the most disadvantaged group of people in any city, which is essentially SH. Massengale (2016) alludes to this because in her first book, *The Death and Life of Great American Cities*, Jacobs already begins to hint at such (most probably social) housing, when she entreated that cities cease demolishing old(er)/aged buildings in order to eliminate the cost of new construction that constitutes a huge part of dissuading developers from erecting pro-poor developments. This was in reference to developments that were already located in good neighborhoods in the city, and that would be renovated with cheap maintenance and longevity in mind.

REFERENCES

1. Adebayo, Bukola. 2018. "Nigeria overtakes India in extreme poverty ranking." *CNN*. Accessed on October 22, 2021. <https://www.cnn.com/2018/06/26/africa/nigeria-overtakes-india-extreme-poverty-intl/index.html>
2. Adejumo, Akintokunbo A. 2008. "Some thoughts on affordable and social housing in Nigeria." *Prototype buildings*.
3. Ajayi, Olumuyiwa O., Faith O. Oviasogie, Dominic E. Azuh, and Moses M. Duruji. 2014. "Urban design and sustainable development: a case of Makoko area of Lagos State, Nigeria." *European Scientific Studies Journal* 2, (105-112)
4. AUMA (Alberta Urban Municipal Association). 2017. "What is affordable housing?" *AUMA*. Accessed on October 6, 2021. <https://www.auma.ca/advocacy-services/programs-initiatives/housing-hub/what-affordable-housing>
5. BBC (British Broadcasting Corporation). 2012. "Nigerians living in poverty rise to nearly 61%." *BBC News*. Accessed on October 22, 2021. <https://www.bbc.com/news/world-africa-17015873>
6. Braga, Michela, and Pietro Palvarini. 2013. "Social Housing in the EU."
7. Carmona, Matthew, Sarah Carmona, and Nick Gallent. 2003. "Delivering new homes: processes, planners and providers". *Psychology Press*, 2003.
8. Cowans, Julie, and Duncan Maclennan, eds. 2008. *Visions for social housing: international perspectives*. Smith Institute.
9. Czischke, Darinka, and Gerard van Bortel. 2018. "An exploration of concepts and policies on 'affordable housing' in England, Italy, Poland and The Netherlands." *Journal of Housing and the Built Environment* (1-21).
10. Daniels-Akunekwe, Chika Chioma. 2021. "Marginal Enclosures: An Exploration of The Viability Of A Social Housing Siting And Maintenance Framework Based On Stakeholder Experience - The Case Of Lagos Metropolitan Area (Lagos City), Nigeria." Unpublished Doctoral thesis, University of Calgary.
11. Daniels-Akunekwe, Chika Chioma, and Brian Robert Sinclair. 2019. The Experience of Engagement: The Importance of Phenomenology in the achievement of Social Rental Housing designs, *In Proceedings of The 16th Symposium on Personal and Spiritual Development in the World of Cultural Diversity* (InterSymp 2019), 29 July – 2 August 2019; Baden-Baden, Germany.
12. EY (Ernst & Young). 2018. "Should resilience begin with the home? How cities can finance and deliver resilient social housing to deliver better outcomes for residents" *100 Resilient Cities*. Accessed on October 7, 2021. https://resilientcitiesnetwork.org/downloadable_resources/UR/Should-Resilience-Begin-At-Home.pdf
13. Ezeanah, Uyi. 2021. "Housing Challenges in Nigeria."
14. Fatoye, E. O., and K. T. Odusami. 2009. "Occupants' satisfaction approach to housing performance evaluation: the case of Nigeria." In *RICS COBRA research conference held at the University of Cape Town*, vol. 10.
15. Festus, Ibimilua Adewale, and Ibitoye Oyewole Amos. 2015. "Housing policy in Nigeria: An overview." *American International Journal of Contemporary Research* 5, no. 2 (23).
16. Fry, Peter. 2020. "Nigeria: poverty capital of the world." *EndPoverty*. Accessed on October 22, 2021. <https://www.endpoverty.org/blog/nigeria-poverty-capital-of-the-world>
17. Granath Hansson, Anna, and Björn Lundgren. 2019. "Defining social housing: A discussion on the suitable criteria." *Housing, Theory and Society* 36, no. 2 (149-166).
18. Harloe, Michael. 1994. "Social housing - past, present and future." *Housing Studies* 9, no. 3 (407-416)
19. Ihuah, Paulinus W., and J. C. Fortune. "Toward a framework for the sustainable management of social (public) housing estates in Nigeria." *Journal of US-China Public Administration* 10, no. 9 (901-913).
20. Ihuah, Paulinus Woka, Iyenemi Ibimina Kakulu, and David Eaton. 2014. "A review of Critical Project Management Success Factors (CPMSF) for sustainable social housing in Nigeria." *International Journal of Sustainable Built Environment* 3, no. 1 (62-71).
21. Ikejiofor, Uche. 1999. "The God that Failed: A Critique of Public Housing in Nigeria, 1975–1995." *Habitat international* 23, no. 2 (177-188).
22. Isah, Abubakar Danladi. "Urban public housing in Northern Nigeria: The search for indigeneity and cultural practices in design". Springer, 2016.
23. Jones, Paul. 2017. "Housing Resilience and the Informal City." *Journal of Regional and City Planning* 28, no. 2 (129-139)
24. Keating, William Dennis, Norman Krumholz, and David C. Perry, eds. 1995. Cleveland: A metropolitan reader. Kent State University Press,
25. Maclennan, Duncan, and Alison More. 1997. "The future of social housing: key economic questions." *Housing Studies* 12, no. 4 (531-547)
26. Makinde, Olusola Oladapo. 2014. "Housing delivery system, need and demand." *Environment, Development and Sustainability* 16, no. 1 (49-69).
27. Massengale, John. 2016. "Introduction to the 1st Annual Jane Jacobs Award at the Met Housing Council." Accessed on November 8, 2021. <https://blog.massengale.com/2016/12/19/jacobs-met-housing/>

28. Moore, Emmanuel Abolo. 2019. "Addressing Housing Deficit in Nigeria: Issues, Challenges and Prospects." *Economic and Financial Review* 57, no. 4 (22-37)
29. NSW (New South Wales Government). "Supply, Diversity, Affordability." *NWS Government Planning, Industry & Environment*. Accessed on October 4, 2021. <https://www.planning.nsw.gov.au/Research-and-Demography/Housing-Evidence-Centre/Housing-affordability>
30. Ocholi, S., D. Manase, J. Lowe, and J. Sonnerville. 2015. "Critical Review of Nigeria National Housing Policies Delivery (NNHPD)." *International Journal of Engineering Research & Technology* 4, no. 9 (718-724).
31. OECD (Organization for Economic Co-operation and Development). "Resilient Cities." *OECD.org*. Accessed on September 29, 2021. <https://www.oecd.org/cfe/regionaldevelopment/resilient-cities.htm>
32. Olawale, S. B., A. A. Lawal, and J. O. Alabi. 2015. "Nigeria housing policy: any hope for the poor." *American Research Journal of Humanities and Social Sciences*, 14 (29-35).
33. Olotuah, A. O. 2000. "The challenge of housing in Nigeria." In *Effective Housing in the 21st Century Nigeria*. Akinbamijo et al. (eds.), Akure: *Environment forum*, (16-21).
34. Olotuah, A. O., and S. A. Bobadoye. 2009. "Sustainable housing provision for the urban poor: a review of public sector intervention in Nigeria." *The Built and Human Environment Review* 2 (51-63).
35. O'Toole, Randal. 2017. "The difference between affordable and affordability in housing." *Page 2*. Accessed on October 7, 2021. <https://pagetwo.completecolorado.com/2017/11/27/the-difference-between-affordable-and-affordability-in-housing/>
36. Panchal, K. (2021). "The poverty capital of the world: Nigeria." Accessed on October 22, 2021. <https://www.borgenmagazine.com/the-poverty-capital-of-the-world-nigeria/>
37. Pendall, Rolf. 1999. "Opposition to housing: NIMBY and beyond." *Urban Affairs Review* 35, no. 1 (112-136).
38. Razwani, Naeem, and Olivia Nielsen. 2021. "Why we need to start financing resilient housing in Africa." *Centre for Affordable Housing Finance*. Accessed on November 2, 2021. <https://housingfinanceafrica.org/documents/why-we-need-to-start-financing-resilient-housing-in-africa/>
39. Rosenfeld, Orna. 2015. *Social housing in the UNECE region: Models, trends and challenges*. United Nations Economic Commission for Europe.
40. Ruonavaara, Hannu. 2018. "Theory of housing, from housing, about housing." *Housing, Theory and Society* 35, no. 2 (178-192).
41. Salama, Ashraf M. 2006. "A lifestyle theories approach for affordable housing research in Saudi Arabia." *Emirates Journal for Engineering Research* 11, no. 1 (67-76).
42. Scally, Corianne Payton. 2014. "Who, Why, and How Communities Oppose Affordable Housing." *Shelterforce: The original voice of community development*. Accessed on November 11, 2021. <https://shelterforce.org/2014/04/23/who-why-and-how-communities-oppose-affordable-housing/>
43. Tighe, Rosie J. 2010. "Public Opinion and Affordable Housing: A Review of the Literature." *Journal of Planning Literature* 25, no. 1 (3-17).
44. Waziri, Aminu Garba, and Ruhizal Roosli. 2013. "Housing policies and programmes in Nigeria: A review of the concept and implementation." *Business Management Dynamics* 3, no. 2 (60).
45. Wood, Elizabeth. 1961. "Housing design: A social theory." *Ekistics* 12, no. 74 (383-392).
46. Worldometer. 2021. "Countries in the world by population." *Worldometer*. Accessed on October 21, 2021. <https://www.worldometers.info/world-population/population-by-country/>

Public Restrooms: A Site of Cultural Conflict

Edward Steinfeld¹, Adam Thibodeaux¹, Shira Gabriel Klaiman¹

¹ University at Buffalo SUNY, Buffalo, NY

ABSTRACT: Public restrooms have become the major locus of conflict over trans*¹ rights. But this is only the latest manifestation of cultural conflicts related to restrooms. Historically, the restroom has been studied through four aligned, but ultimately separate, lenses: gender studies, public health, ergonomics, and proxemics. These four lenses are both interdependent and intersectional. Using the lenses as a point of departure, a review of existing literature paints a broad picture of how this conflict represents the gulf between embedded cultural values and the lived experience of a diverse population. We hypothesize that there is strong consensus on what people desire in toilet rooms, particularly regarding safety, hygiene, and privacy but these desires conflict with a cultural legacy based on hetero-normative values. This hypothesis was tested through a comparative analysis of existing research threads and preliminary findings from a survey that targets the intersections of gender identity, public health, ergonomics, and boundary regulation. This research leads to a holistic picture of the public restroom and situates the contemporary conflict as the result of polarized public opinion. Demographics and ideology play an important role in forming opinions which suggests that design needs to address local variations in the level of acceptance of inclusive restroom design practices. Design research can inform how inclusive restroom design can be implemented in different contexts. While the public restroom is the primary site of interest, this research improves our understanding about the larger issues of how our built environment might adapt in response to a more nuanced view of gender and how urban spatial practices might serve as catalysts for social change.

KEYWORDS: inclusive design, gender, restrooms, health

INTRODUCTION

In recent years, public toilets have become the major spatial locus of conflict over trans* rights. But the trans* population is not the only one that has problems with toilet rooms. Human rights advocates recognize the importance of public toilets for dignity, health, and social participation (Klasing and Smaak 2017). In low-income countries, providing safe and secure public toilets to reduce the spread of disease is a major public health initiative (Centers for Disease Control, 2021). For girls and women, “toilet security” is a particularly important factor in access to education and social participation (O’Reilly, 2016). Advocates have identified the “potty parity” problem as evidence that even high-income societies have not physically adapted to full equality for women (Anthony and Durfresne 2007, Rauchesein 2019, Shure 2019). Although many countries may have turned the corner on access for people with disabilities, it remains a major issue in the developing world. Even in high income countries, there are still some people with severe disabilities and needs for assistance whose toileting needs are not covered by existing practices (Serlin 2010).

Why is it so difficult to ensure equality of access to public toilets, find pleasant facilities, and implement design practices that support safety, good health, and function? Public toilets have been around for over 2000 years! Over a decade ago, Molotch (2010) observed that there is an inherent practical and emotional conflict between the intimate acts of personal hygiene that take place in these facilities and their public nature. Barcan (2010) delved into the role that waste plays in our emotional response. Toilets put people into direct contact with waste, or dirt, which is an “offense against order.” This aligns with Kristeva’s interpretation of abjection - an emotional response to situations that trigger unsettling feelings by disturbing order (Kristeva 1982). Essentially, as an architectural element, public toilet rooms *embody* abjection. They are always places of charged emotional content because they upset our notions of psychological and social order. Encounters with trans* individuals, even if only imagined, heighten abjection by adding a confrontation with otherness. Recent empirical research identified “disgust” as a common emotional response to the idea of sharing toilet rooms with trans* individuals (Taylor et al. 2018). A qualitative study collected testimony from 100 trans* individuals that graphically illustrates how this group becomes the object of abjection by many cisgender and heteronormative individuals, including public safety personnel who are ostensibly tasked with protecting everyone who is law abiding (Cavanaugh 2010).

Studying this ubiquitous space type can help to identify new spatial practices might benefit many groups of people. It can also identify how the conflicting emotions of using toilet rooms can be ameliorated for all patrons of public toilets. Elevating the toilet room from a place of unease to a place of comfort, opportunity, growth, and discovery – a true “rest room” - could radically change this ubiquitous architectural element from one we try to avoid to one that we value. The topic is particularly timely, not only due to the emergence of toilet rooms as a battleground for trans* access, but also because the recent impact of the COVID 19 pandemic uncovered major shortcomings of the contemporary toilet room paradigm for public health.

It is noteworthy that the public discourse about trans* access has neglected the role of design in supporting social change (Sanders et al. ND). In comparison, the disability rights movement recognized the importance of changing design practices, especially in toilet rooms. Yet, the possibility of changing these practices has not been promoted by policy makers, although there are many facilities where innovative designs have been implemented. This demonstrates the persistence of the binary model of gender which underlies the current policy and design approaches to public restrooms. Even those policymakers seeking to protect the trans* population seem to have difficulty rethinking this model.

Advocates of trans* access, together with allies from the profession of architecture, have proposed many well-reasoned design strategies to overcome opposition (Sanders et al. ND, Neumiller 2020, Bryan 2018). Adoption of these strategies could benefit the broader population as well as many underrepresented groups. Eliminating the gender-based territorial distinctions would even benefit cisgender women by truly creating “potty parity,” improving privacy and increasing security through better surveillance of shared areas. Thus, adoption of an inclusive model can be a catalyst for reconceptualizing the toilet room from the ground up. The need for this is apparent since there are many things to dislike about contemporary restroom design from a public health perspective apart the trans* inclusion issue (Neumiller 2020, Sanders et al. ND, Cavanaugh 2010).

No research has yet been completed to verify whether proposals for design solutions would resolve the conflicts about trans* inclusion. Such information would be very helpful to support policy development, increase adoption of the inclusive model by code officials and building owners, and influence public opinion. In particular, it is important to uncover what design solutions might be most appropriate in different social contexts since attitudes are likely to vary with different groups of building inhabitants.

1.0 LITERATURE REVIEW

Several theoretical perspectives offer insights into how the design of toilet rooms might influence acceptance of trans* inclusion. Lofland (1973) conceptualized the city as a “world of strangers.” She argued that the large scale of contemporary life requires the use of “categorical knowing” to set expectations and predict outcomes of encounters with others. Categorical knowing relies on easily perceivable cues to evaluate the stranger, like cues used to identify gender. Incongruence between expectations of gender performance and the presentation of trans* individuals seem to be at the root of abjection (Cavanaugh 2010). Goffman (1967) described the dynamics of how social encounters play out in public and the importance of cultural context. Rituals for relationships between people based on gender are deeply engrained in cultures. Interaction rituals include boundary regulation behavior to maintain appropriate social distances (Hall 1969, Altman 1975). In crowded environments such as toilet rooms, humans use compensatory behaviors to avoid serious conflict. These behaviors typically reduce the amount of information communicated, repress the automatic flight response, or warn others that they are too close. The physical environment of toilet rooms can support or inhibit boundary regulation through the amount of space provided, security features and the number of fixtures provided. Spatial syntax (Hillier and Hanson 1984) also structures interactions by shaping information flows and paths of travel through space. For example, two entries provide options for escaping a toilet room if an occupant threatens violence or starts to be abusive. And visual and acoustic access to the common spaces of a toilet room from a public area can deter violence and abuse by making individuals in the space more socially accountable.

Existing research on trans* access to public toilets demonstrates the need for intervention from a mental health perspective (Hardacker et al. 2019, Caba 2020). Qualitative research has documented the lived experiences of trans* individuals and how they cope with binary-model public toilet rooms (Mathers 2017, Hardacker et al. 2019, Cavanaugh 2010). Lack of access to safe public toilets is associated with behaviors (e.g. postponing voiding, limiting hydration) that cause physical health conditions (e.g. UTIs) and increased prevalence of mental health issues like chronic anxiety and fear about voiding and negative self-perceptions. There has been very little research on boundary regulation related to the issue of trans* inclusion. A study by Uzell and Horne (2006) found that gender plays a more important role in determining interpersonal distance than sex or sexual orientation. People who score high on a scale of masculinity maintain larger interpersonal distances from each other than those who score high on femininity and in between. Genetic sex and sexual orientation did not have nearly as strong a relationship with social distance.

There is some existing research on design features of inclusive bathrooms. Chaney and Sanchez (2018) found that gender inclusive signs on bathrooms signaled safety for women and minorities because they represented fairness and a more positive gender and racial climate. A recent survey of trans* and cisgender university students demonstrated that cisgender respondents preferred single user restrooms by a huge majority while trans* respondents split their preferences almost equally between single user restrooms and all gender multi-user restrooms (Caba, 2020). Cavanaugh’s qualitative research with a trans* population (2010) uncovered a vast number of design issues that make the experience of using binary model toilet rooms fraught with anxiety and discomfort. These issues are multisensory in nature (visual, acoustic, olfactory and tactile) and are moderated by multiple design features that influence the perception of privacy, security, avoidance behavior, and interpersonal interaction. An unpublished post-occupancy study found that “all-gender” multi-user restrooms in public schools that provided partial visibility from public corridors for easy supervision and full height partitions in toilet compartments were perceived to increase security (Neumiller 2020). This suggests that good design can not only address the argument that all-gender restrooms in schools reduce security for girls but also increase security for all users, especially those who are vulnerable to abuse and bullying.

The existing research has been limited to a few design features, used small samples of participants, and did not include a comparison of design alternatives. For example, Cavanaugh (2010) studied 100 individuals, but they were all drawn from the trans* population. Cheney and Sanchez (2018) recruited a large and diverse sample but focused on a very limited topic. Uzell and Horne (2006) conducted a laboratory study with a contrived experience unrelated to toilet rooms. There is significant evidence that the trans* population is not the only group impacted by the contemporary public toilet model (Sanders et al. ND). Women suffer from disparity in waiting times (Shure, 2019) and there are many people with disabilities whose needs are not met by minimum accessibility regulations (Serlin 2010). Many cisgender individuals have anxiety about urination, menstruation, constipation, self-catherization or emptying colostomy bags (Caba 2020). Sanitation remains a major hygiene problem, especially for women. A systematic review of urination behavior by women discovered that, in almost every study, the majority of respondents reported that they avoid urination in public toilet rooms by postponing voiding until they can return home; poor sanitation was the primary reason (Wu et al. 2019). Water is used for anal hygiene by half the world's population but only paper is available in the standard North American toilet compartments. Water and paper each have advantages and disadvantages for hygiene and from a sustainability perspective (Garg et al. 2016). In North America, individuals who prefer the use of water may feel considerable social pressure to hide the ad hoc methods they use to accommodate their needs (Akbar 2014). It is likely that there are a lot more people using water for anal hygiene than is readily apparent. And sanitary wipes are becoming more popular as a third alternative (Garg et al. 2016).

Even contemporary fixture design has limitations from a health perspective. It has long been known that squat toilets are healthier than the upright seating posture that is a universal practice in European and American cultures (Kira 1976). Urination in public settings is particularly difficult for many individuals. Squatting/sitting to urinate is a healthier alternative for cisgender women and trans* women than standing (Stevens 2020). Sitting/squatting also helps to improve “urodynamics” for cisgender men with lower urinary tract symptoms from enlarged prostates (de Jong 2014) but current fixture design optimizes standing for men. On the other hand, heightened concern for sanitation during the COVID 19 pandemic significantly increased interest in standing to urinate among cisgender women (Stevens 2020). Standing to urinate can also benefit trans* men but currently, the design of urinals lacks the privacy needed to prevent anxiety over the fear of victimization.

The existing research highlights the general importance of improving sanitation and increasing options for toileting, urination, and self-care in public toilet rooms. It also demonstrates the importance of increasing privacy to reduce the stigma of practices that are not acceptable to the dominant culture. Our recent experience with the pandemic provides an opportunity to compare opinions about spatial practices related to trans* access with those related to public health. New spatial practices implemented during the pandemic in public toilet rooms have included installing floor markings as cues for social distancing, adding and increasing the size of partitions at urinals, reducing occupancy loads to avoid crowding, increasing space between compartments by closing off half the compartments, improving hand washing facilities, providing dispensers with sanitizer, and providing public health information to reinforce compliance with public health guidelines. Thus, the population has become much more aware of how the public toilet environment supports health through regulation of social interactions.

All the health issues noted above are also related to trans* access. For example, eliminating gender segregation would alleviate potty disparity while affirming trans* equality; provision of private compartments for urination would reduce anxiety for both cisgender men with urination anxiety as well as trans* men; it would also enable women to stand to pee without embarrassment. Improving privacy through full height compartment partitions and doors would reduce disease transmission while also reducing social anxiety related to gender and practices that deviate from cultural norms. Providing options for fixture design could address preferences for hygiene as well as providing options for different gender identities and anatomies. Thus, exploring preferences for these features could uncover consensus on how to improve toilet room design for both inclusion and health. By understanding the reasons behind preferences could also clarify reasons for opposition (e.g. transphobia, misunderstandings, misinformation, religious beliefs) which, in turn, could help to identify important strategies for public policy, education and even litigation.

2.0 RESEARCH METHODS

This study is part of a broader research initiative on inclusive restroom design. The overall research initiative includes surveys, qualitative interviews, and documentation of best practices. We plan to continue collecting data from many different populations and locations. Primary goals of the research are to identify strategies for inclusive restroom design that can gain wide acceptance by diverse segments of the U.S. population and learn how the introduction of innovative restroom design might respond to different social contexts. The results will inform policy makers, advocates, designers, design educators, product manufacturers, and facility managers on best practice approaches to trans* inclusion and health for all users. The initial phase reported here is a survey of opinions toward inclusive restroom designs in a university student population. In this paper, we focus on one research question: *Do features that improve gender inclusion and health have widespread appeal?* Our hypothesis is that they do.

The survey research was conducted through an online survey using Survey Monkey. The protocol was approved by the University at Buffalo (UB) Institutional Review Board. The questionnaire utilizes a Likert style response format with 7 points for all opinion questions although the ratings differed, depending on the design feature studied. Ratings

addressed acceptability of restroom designs including the conventional binary model of men's and women's rooms. A section on self-reported demographics and ideology concluded the questionnaire. The rating questions included illustrations of designs in plan form and brief text descriptions. Drawing conventions, like door swings, partition walls, fixtures, etc. were explained to aid interpretation by non-designers. The questionnaire was pretested and revised as needed to ensure that the wording and illustrations were understandable. Pretesting demonstrated that the entire survey took about 20 minutes to complete.

The first wave of the survey was launched with undergraduate students taking introductory psychology courses with a requirement to participate in research. Students could select which research they wanted to participate in from a list of available studies. A maximum of 300 students were allowed to take this survey, to ensure that the other surveys would have enough respondents. Figure 1 shows the restroom designs that were presented to the students. The differences for trans* inclusion and health, as informed by the literature review, are summarized in Table 1. Respondents were informed that all the rooms would have full height partitions and doors. Restrooms A, B and C were rated twice by the respondents. The first time, the instructions were: *Rate the acceptability of each layout below if they were to be used by men and women.* The second time, the instructions were *Rate the acceptability of each layout below if they were to be used by men, women, transgender and gender non-conforming individuals.* These two questions allowed us to assess whether specific mention of trans* inclusion would affect the ratings.

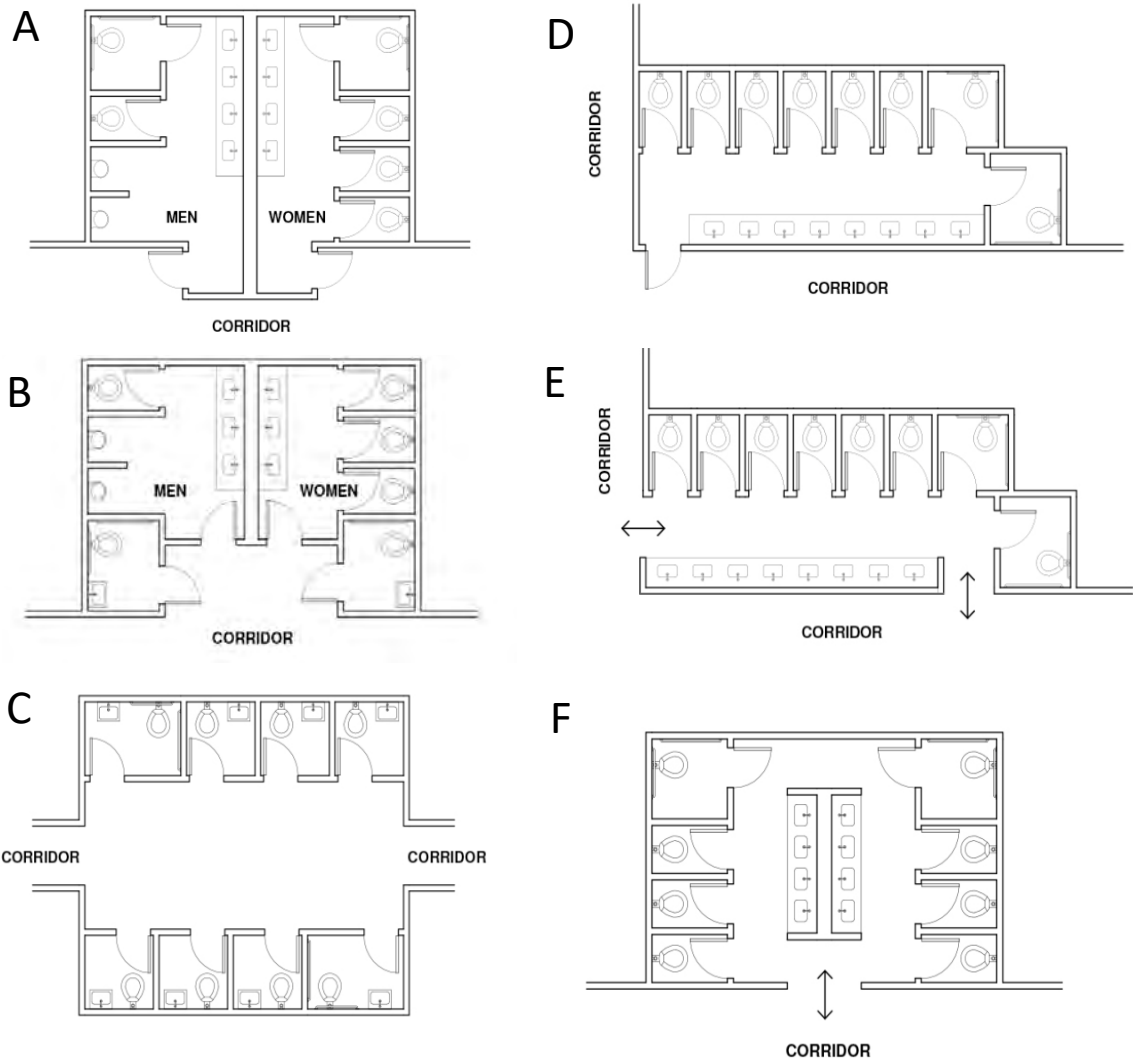

Figure 1: Restroom plans used in the survey

3.0 RESULTS

Three hundred (300) students completed the survey. About 97% of the sample were between 18 and 24 years old. 56% of the sample identified as women, 43% as men, and 2.7% as trans* of one form or another. Less than 1% either did not answer or answered “other”. About 81% of the sample identified as heterosexual; 2% as gay men; less than 1% as lesbian; and more than 10% as bi-sexual. About 5% either did not answer or answered “Other.” About 73% of the respondents had no health conditions. Health conditions reported included urinary related problems (5%), problems with defecation including bowel diseases (less than 1%), and menstrual issues (8 %). About 18% reported anxiety using public restrooms for any reason. The most prominent functional limitation reported (24%) was “mental health conditions” such as anxiety and depression.

Table 1. Differences in Restroom Designs

Plans	Gender Inclusion	Health
A	<ul style="list-style-type: none"> + Affirmation of identified gender for binary model + Perceived security for cis women¹ - Potential for misgendering, violence and abuse against trans* users - Limited social distancing between cisgender and trans* users² 	<ul style="list-style-type: none"> - Long waiting times for women when crowded - Mixed gender couples cannot aid each other - No sink in accessible stalls for hygiene and medical procedures - Exposed urinals create performance anxiety - Limited space for social distancing
B	<ul style="list-style-type: none"> + Options to use gender identified room or single user room + Reduces potential for misgendering, violence and abuse of trans* users + Retains perceived security for cis women¹ + Reduces encounters through syntax² 	<ul style="list-style-type: none"> + Reduces waiting times for women + Sink in accessible stalls for hygiene and medical procedures - Exposed urinals create performance anxiety - Limited social distancing for disease transmission
C	<ul style="list-style-type: none"> + Reduces potential for violence and abuse of trans* users³ + Retains perceived security for cis women¹ + Greatly increases social distancing between users of all genders² 	<ul style="list-style-type: none"> + Eliminates bathroom access inequalities for women but men will encounter longer waiting times when crowded + Allows mixed gender couples to help each other + Sinks in all compartments for hygiene and medical procedures + Lack of exposure of sinks reduces peer pressure to wash + Lack of urinals reduce performance anxiety - Lack of urinals creates sanitation issues
D	<ul style="list-style-type: none"> + Affirmation of multiple gender identities - Reduces perceived security for women¹ - Increases potential for violence and abuse of trans* users³ - Limited social distancing between cisgender and trans* users² - Single entrance and door could be exploited by violent people to entrap victims 	<ul style="list-style-type: none"> + Eliminates bathroom access inequalities for women + Allows mixed gender couples to help each other + Lack of open urinals reduces performance anxiety for men - Men will encounter longer waiting times when crowded - No sinks in compartments for hygiene and medical procedures - Lack of urinals creates sanitation issues
E	<ul style="list-style-type: none"> + Two entries and lack of doors increases security³ - Limited social distancing between cisgender and trans* users² - Lack of gendered territories reduces perceived security for women¹ - Two entrances and lack of doors reduces privacy 	<ul style="list-style-type: none"> + Eliminates bathroom access inequalities for women + Allows mixed gender couples to help each other + Lack of open urinals reduces performance anxiety for men - Men will encounter longer waiting times when crowded - No sinks in compartments for hygiene and medical procedures - Lack of urinals creates sanitation issues
F	<ul style="list-style-type: none"> + Reduces perceived crowding + Reduces victimization of trans* users³ + Retains perceived security for cis women¹ + Expanded social distancing between users of all genders² - Reduces privacy in shared space 	<ul style="list-style-type: none"> + Eliminates bathroom access inequalities for women + Allows mixed gender couples to help each other + Lack of open urinals reduces performance anxiety for men + Sinks in compartments support better hygiene and medical procedures - Men will encounter longer waiting times when crowded - Lack of urinals creates sanitation issues

- ¹ Territorial control based on gender is perceived to be a deterrent to assault to some cisgender women but there is no reliable evidence to support that belief.
- ² Some research indicates that mixed gender pairs feel more comfortable with greater social distance and that people prefer larger social distances in encounters with masculine appearing individuals.
- ³ Increased exposure of shared space to public areas can increase social accountability.

About 33% of the respondents identified as Democrats, 11% as Republicans and 34% as Independent or Unaffiliated. 21% either preferred not to answer or listed “Other.” 43% reported that they identified as Christian, 19% as atheist or agnostic. About 13% reported that they were Muslim, Buddhist, Hindu, Jewish or Pagan. About 25% did not answer the question on religion or selected “Other”. About 25% agreed that there is a biological reason why people are transgender and about 31% were ambivalent about it; 24% disagreed.

We ran two Within Participants Analysis of Variance (ANOVA) to examine ratings of the bathroom layouts. The first had two factors: the bathroom layouts (A, B, and C) and whether trans* users were mentioned in the directions. The effect for layout was significant $F(2, 293) = 27.81; p < .001$. The completely mixed gender solution (layout C) was rated least acceptable. In addition, the interaction was significant $F(2, 293) = 12.98; p < .001$. When trans* users were explicitly mentioned, respondents were less positive about layout A but both more positive and more ambivalent about layout C. In other words, thinking about trans* users led participants to increase their preference for mixed gender bathrooms and decrease their preference for single gender bathrooms. The second ANOVA looked at preferences for layouts D, E, and F and also found significant differences in their evaluation $F(2, 296) = 15.60; p < .001$. Of these three, participants rated F the most acceptable. Ratings of options D and E did not significantly differ from one another. Table 2 displays the ratings for the six restroom designs in a condensed form as percentages and frequencies.

Table 2. Ratings of Restroom Designs

Design	Unacceptable		Neither		Acceptable		N
	%	n	%	n	%	n	
A ¹	6%	17	13.76%	41	80.54%	240	298
B ¹	11%	34	17.06%	51	71.57%	214	299
C ¹	29%	87	17.33%	52	53.67%	161	300
A ²	11%	34	16.05%	48	72.58%	217	299
B ²	9%	26	19.73%	59	71.57%	214	299
C ²	23%	69	21.00%	63	56.00%	168	300
D	21%	64	25.17%	75	53.36%	159	298
E	24%	73	20.33%	61	55.33%	166	300
F	17%	50	19.00%	57	64.33%	193	300

Note: Subscript refer to wording differences in the two sets of items: 1 – did not mention trans* users, 2- mentioned trans* users

4.0 DISCUSSION

Although the sample was composed almost entirely of young adults, a significant minority reported health related problems with urination and defecation, issues usually associated with older groups. The sample was heavily heterosexual and cisgender. Although there were significant differences in ratings with the conventional binary model receiving the highest ratings, it is noteworthy that a majority of the respondents rated *all* the designs as “acceptable”. The explicit mention of trans* users slightly increased acceptance of the most “inclusive” solution, C, while also slightly increasing ambivalence. These results only partially confirm our hypothesis. There is some ambiguity in the results. The preference for the conventional model could reflect a general tolerance of trans* inclusion as much as it does opposition to inclusion. We collected open ended comments to all parts of the questionnaire and only one female respondent stated an opposition to sharing space with men. This younger sample might also not appreciate the health and security advantages of some of the designs, notably B and C, as identified in Table 1. It is noteworthy that design E is close to the model proposed by Sanders et al. and used by the St. Paul school district, but for this population was not viewed as positively as other designs. This may reflect a desire for more privacy among young adult population.

The relatively low ratings for layout C are surprising given that Caba (2020) found cisgender students overwhelmingly preferred single user restrooms. However, Caba did not show respondents plans or describe the features of the rooms as we did in this study. Caba also forced a choice between gender segregated multi-user restrooms, all gender multi-user restrooms, and single user restrooms, whereas we asked respondents to rate each separately. About 20% of Caba’s population identified as gender minorities. Thus, Caba was able to compare the choices of the two groups. Due to the small numbers of respondents identifying as trans*, we were not able to make that comparison. Caba did not disclose the three universities from which her sample was recruited but she noted that the campuses may have a more politically and socially progressive population than most universities. It is also possible that students at UB have less experience with all-gender restrooms than the population from which Caba and Cavanaugh recruited.

The absence of urinals in C, D, E and F may have contributed to their relatively lower acceptance ratings. Cisgender men may view this as an inconvenience and women (including transgender women) may perceive sanitation as an issue when sharing with people who urinate standing up. The relatively high ratings of plans B and F, in comparison with C, D and E, suggests that privacy and spatial syntax play an important role in acceptability. Both B and F reduce exposure to the public corridor, and both reduce the number of people one is likely to contact during a visit. Verification is needed but Plan B could be a good solution where restrictive laws are in place limiting trans* access and requiring separate men's and women's rooms. But where building codes require all single gender toilet rooms to be accessible, additional accessible compartments would be needed in the designated men's and women's rooms. Plan F could be a good solution where laws provide more flexibility.

CONCLUSION

The literature review identified the emotional conflict inherent in using public restrooms, the negative health impact of conventional design, the many groups that could benefit from an inclusive approach, and the myriad of design issues that need to be addressed to achieve it. Inclusive design should address physical and mental health issues, sanitation, security, convenience, and cultural differences in addition to gender inclusion. Gender inclusion is not an issue solely of concern to the trans* population. Equity for women is still an important design goal (Shure 2019). The conventional gender-segregated and policed restroom can be understood as a reflection of a culture that supports a rigid idea of gender identity, neglects the realities of diverse needs, and adheres to a euro-centric approach to elimination practices (Kogan 2016, Cavanaugh, 2010, Sanders et al. ND, Shure 2019). Cultural change is increasing demand for more inclusive approaches.

The study suggests that innovative inclusive restrooms are acceptable to most undergraduate students. It also suggests that some solutions are more acceptable than others. But none of the "inclusive" designs reached the level of acceptance as the binary model did. Clearly the study has limitations due to the population studied and the limited features depicted in the designs. In future analysis, we will delve deeper into the relationships between gender, health, ideology, and ratings using the expanded data set. We are also preparing to launch more research cycles to reach the LGBTQ+ population and more age-diverse populations, both within and outside the university setting. Further, an interview study will help us understand how different groups interpret the designs. It will allow us to explore how the presence or absence of urinals, different degrees of privacy, and alterations of spatial syntax influence preferences.

Unfortunately, in many parts of North America today, attempts to depart from the conventional binary model of restroom design are very likely to be politicized and provoke acrimony from those who view the effort to provide trans* access as an indicator of cultural degeneration, an attack on deeply held religious beliefs, or at worst, part of a conspiracy to convert cisgender people to a trans* "lifestyle." Trans* access, however, is a public health issue that intersects with problems faced by other populations and should be presented as such. Building owners and designers who seek to provide better access should engage their constituencies in a conversation about the broad limitations of conventional restroom design and, when presenting design strategies, focus on the benefits of new models for other groups as well as the trans* population, especially those important for the female half of the population and minority religious and ethnic groups. This may be a better approach to address resistance than a purely human rights argument.

Supporters of trans* access to restrooms have focused on changing laws to require all-gender access. Although important, laws in themselves do not address the whole problem. A transgender woman or gender non-conforming person could still experience violence and abuse in a conventional men's or women's room even if the law allows them to choose which one to use. In fact, it could inculcate a false sense of security and incite even more violence in some locales. Further, launching such initiatives, without attention to design, can cause backlash leading to support for laws designed to force trans* people to use restrooms that align with their birth sex. Such laws, of course, will not eliminate gender dysphoria and likely leads to misgendering trans* and cisgender people alike. Inclusive design can reduce conflict by making use of restrooms more comfortable and stress free for all users. Over time, it might also reduce transphobia by increasing awareness about gender diversity and reducing reliance on categorical knowing based on visible gender markers.

A simple strategy for improving trans* access, is re-signing single user restrooms to be "all-gender." This is a good initial first step because it provides options for both the trans* population and cisgender people who desire more privacy in using restrooms, but it can be perceived as a form of segregation and imparts a stigma if it is the only option for trans* users, especially if such restrooms are located inconveniently. Further, such initiatives do not address the quality of the restroom itself, neglecting all the other issues identified above. Several design firms and building owners have started initiatives to go further. We have identified some examples of inclusive multi-user restrooms that we intend to study intensively using qualitative methods to see how they are working over the next year. We welcome information on any other examples by readers. Clearly another arena for changing practices is in architectural education. Two of the co-authors teach design studios and seminar classes in which we are incorporating both research and design activities focused on inclusive restroom design. Our students find this topic interesting and relevant. They address it with creativity and enthusiasm. The focus on restrooms provides a manageable opportunity for students to learn principles of inclusive design that can also be applied to other aspects of architectural design.

We believe that designs that provide benefits for a broad population and address the unconscious conflict inherent in doing private things in public, will help to overcome resistance. The design professions play important role in cultural change. Designers can imagine alternatives and have the professional authority to persuade clients and the public to adopt new ideas. But, other than styling, few have paid much attention to the restroom. The opportunity is here to start designing restrooms that can demonstrate how design helps a diverse population live better together. Public restrooms are key spaces that make our communities more equitable. No one can live without them and our cities would literally and figuratively be a mess if we don't do it right.

REFERENCES

- Akbar, J. . A Muslim's Guide to Anal Hygiene." *Vice*, 12-11-2014.
- Altman, Irwin. 1975. *The Environment and Social Behavior*. Monterey CA: Brooks Cole.
- Anthony, K. H. & , and M. Dufresne. 2007. "Potty Parity in Perspective: Gender and Family Issues in Planning and Designing Public Restrooms." *Journal of planning literature* 21, no. 3: 267-94.
- Barcan, Ruth. 2010. "Dirty Spaces." In *Toilet*, ed. by Molotch H, Norén L, 25-42. New York: New York University Press.
- Bryan, N. 2018. "A Restroom for Everyone," *Research&Insight. Gensler*.
- Caba, A. 2020. "Associations between Campus Restroom Use and Mental Health among Gender Minority and Cisgender Students " M.P.H., Yale University.
- Cavanagh, Sheila L. 2010. *Queering Bathrooms : Gender, Sexuality, and the Hygienic Imagination / Sheila L. Cavanagh*. Toronto :; University of Toronto Press.
- Chaney, K. E. & Sanchez, D. T. 2018. "Gender-Inclusive Bathrooms Signal Fairness across Identity Dimensions." *Social Psychological & Personality Science* 9, no. 2: 245-53.
- de Jong, Y., Pinckaers, J. H. F. M., ten Brinck, R. M., Lycklama à Nijeholt, A. A. B., & Dekkers, O. M. 2014. "Urinating Standing Versus Sitting: Position Is of Influence in Men with Prostate Enlargement. A Systematic Review and Meta-Analysis. ." *PLoS ONE* 9, no. 7: 1-9.
- Garg, P. & Singh, P. 2016. "Postdefecation Cleansing Methods: Tissue Paper or Water? An Analytical Review. ." *Diseases of the Rectrum* 59, no. 7: 696-99.
- Goffman, E. 1969. *Interaction Ritual*. Garden City NY: Anchor Books.
- Hall, E. T. 1969. *The Hidden Dimension*. Garden City, NY: Anchor Books.
- Hardacker CT, Baccellieri A, Mueller ER, Brubaker L, Hutchins G, Zhang JLY, Hebert-Beirne J. 2019. "Bladder Health Experiences, Perceptions and Knowledge of Sexual and Gender Minorities." *International Journal of Environmental Research and Public Health* 16, no. 17.
- Hillier, B., and J. Hanson. 1984. *The Social Logic of Space*. New York, NY: Cambridge University Press, 1984.
- Kira, A. *The Bathroom*. New York: Viking Press.
- Klasing, A. & Smaak, and A. 2017. "Sanitation as a Global Right." Human Rights Watch. Accessed 6-29-21. <https://www.cdc.gov/healthywater/global/index.html>
- Kogan, T. 2016. "How Did Public Bathrooms Get to Be Separated by Sex in the First Place? ." The Conversation. Accessed 6-29-21. <https://theconversation.com/how-did-public-bathrooms-get-to-be-separated-by-sex-in-the-first-place-59575>.
- Kristeva, J. 1982. *Powers of Horror*. New York: Columbia University Press.
- Lofland, L. H. 1973. *A World of Strangers: Order and Action in Urban Public Space*. New York: Basic Books.
- Mathers, L.A. B. 2017. "Bathrooms, Boundaries, and Emotional Burdens: Cisgendering Interactions through the Interpretation of Transgender Experience." *Symbolic Interaction* 40, no. 3: 295-316.
- Molotch, H. 2010. "Introduction: Learning from the Loo." In *Toilet*, edited by H. & Norén Molotch, L. New York: New York University Press.
- Neumueller, H. 2020. *Inclusive Restroom Design Guide*. Minneapolis: Cunningham Group.
- O'Reilly, K. 2016. "From Toilet Insecurity to Toilet Security: Creating Safe Sanitation for Women and Girls." *Water* 3: 19-24.
- Rauchesein, N. 2019. "The Real Reason Women's Bathroom Lines Are So Long." YouTube. Accessed 6-29-21 <https://www.youtube.com/watch?v=GBJeZzA6f6s>.
- Sanders, J., Stryker, S. and Kogan, T. ND. "Stalled!", Accessed 6-29-21. <https://www.stalled.online/>
- Serlin, D. 2010. "Pissing without Pity: Disability, Gender and the Public Toilet." In *Toilet*, edited by Molotch H and Norén L. New York: New York University Press.
- Shure, N. 2019. "The Politics of Going to the Bathroom." *The Nation*, 5-23-19.
- Stevens, J. 2020. "The She-We Generation: How 2020 Has Changed Urination." *The Guardian*, 9-3-20.
- Taylor, J., Lewis, D., & Haider-Markel, D. 2018. *The Remarkable Rise of Transgender Rights*. Ann Arbor: University of Michigan Press. doi:10.3998/mpub.9448956.
- Uzell, D. & Horne, N. 2006. "The Influence of Biological Sex, Sexuality and Gender Role on Interpersonal Distance." *Journal of Social Psychology* 16, no. 20: 579-97.
- Wu, Chen, Kaikai Xue, and Mary H. Palmer. 2019. "Toileting Behaviors Related to Urination in Women: A Scoping Review." *International journal of environmental research and public health* 16, no. 20: 4000..

ENDNOTES

¹ Trans* is a relatively new term used to encompass a wide range of gender identities including transgender, intersex, gender non-conforming, gender fluid, and others.

Adaptive Streets: Increasing Social and Ecological Resilience Along a Cross-City Bicycle Boulevard

Courtney Crosson¹

¹University of Arizona, Tucson, AZ

ABSTRACT: Streets represent roughly 70-90% of cities' public open spaces. Streets connect a variety of citizens with diverse needs. In addition to being conduits, streets act as an important amateur on which an array of public services can be built for social and ecological benefit. This paper examines the case study of the design of a bicycle boulevard in Tucson, Arizona and the tailored community engagement activities used to address the needs of six unique neighborhoods across its length. To complete the design, a public-academic partnership was formed between neighborhood associations, Tucson Department of Transportation planners, County Flood Control District hydrologists, and the University of Arizona (UA). Led through an UA upper-level design studio, the partnership used speed studies, pedestrian and bicycle counts, online surveys, participatory community mapping, and participatory visioning exercises to collect quantitative and qualitative data to tailor the designs to each neighborhood's expressed needs. The final design used a kit-of-parts approach to propose an adaptive street model that addressed chronic ecological and social equity issues along its length. Adaptive elements reduced flooding, shaded pedestrian and bicycle protected paths, increased safety measures and traffic calming, and diversified neighborhood place-specific social areas. The paper argues that context-specific, adaptive designs can be systematically created through community engagement processes tailored to the diverse communities along the extents of a city street. The six-mile bicycle boulevard design is slated to be constructed from the northern to southern city limits.

KEYWORDS: adaptive streets, ecological resilience, social equity, bicycle boulevard

INTRODUCTION

Transportation systems have historically been designed to move the greatest number of vehicles as efficiently as possible across a city from point to point. However, streets also represent roughly 70-90% of cities' public open spaces (NACTO 2020). Streets connect a variety of citizens with diverse needs. In addition to being conduits, streets act as an important amateur on which an array of public services can be built for social and ecological benefit.

Flooded streets are not safe or accessible streets. The Fourth National Climate Assessment warns of increases in the intensity and duration of precipitation events, leading to a greater severity and frequency of flash floods in portions of the United States (Wuebbles 2017). In 2016 alone, the United States suffered estimated property damages of \$15 billion dollars and 83 deaths from flash floods – comprising over half of all damages caused by natural disasters in the United States and the highest death rate. This concern is exacerbated by a national trend in deteriorating storm water infrastructure and increased urbanization with densification of impervious land cover (Wuebbles 2017). Solutions are provided by new Complete Streets policies that enable safe use and support mobility for all users (USDOT, 2020) and green stormwater infrastructure (GSI) installations that reduces flooding while offering multiple community benefits. Green stormwater infrastructure filters and absorbs stormwater where it falls and can be implemented at multiple scales (EPA 2020). However, these multi-user and multi-benefit solutions require community engagement to be optimally design and implemented for specific community needs and conditions. These multi-user and multi-benefit designed streets are “adaptive streets” unique to the social and ecological needs of the community.

This paper examines the case study of the design of a bicycle boulevard in Tucson, Arizona and the tailored community engagement activities used to address the needs of six unique neighborhoods across its length to increase neighborhood assets and reduce flooding. This work was supported by a new city Complete Streets policy and Green Stormwater Infrastructure fee and conceptualized as an adaptive street. To complete the adaptive street design, a public-academic partnership was formed between neighborhood associations, Tucson Department of Transportation planners, County Flood Control District hydrologists, and the University of Arizona (UA). Led through an UA upper-level design studio, the partnership used speed studies, pedestrian and bicycle counts, online surveys, participatory community mapping, and participatory visioning exercises to collect quantitative and qualitative data to tailor the designs to each neighborhood's expressed needs with a kit-of-parts approach that allowed crucial adaptability. This paper discusses the community engagement, kit-of-parts approach, and the resulting community designs of the adaptive streets. Overall, adaptive elements reduced flooding, shaded pedestrian and bicycle protected paths, increased safety measures and traffic calming, and diversified neighborhood place-specific social areas. The paper

argues that context-specific, adaptive designs can be systematically created through community engagement processes tailored to the diverse communities along the extents of a city street.

1.0 LITERATURE REVIEW

1.1 Adaptive streets: complete streets policy and design approach for multimodal users

Complete Streets are streets designed to ensure safe and assessable use across multiple modes and user types. By 2018 nearly 1,500 Complete Streets policies had been adopted across the U.S. (Riveron 2018). Complete Streets have been found to improve community health, increase safety, and advance economic development (Dodds 2017). However, comprehensive reviews of these policies find a consistent deferral to idealistic goals without recognizing the need to negotiate the trade-offs between the many users and modes prioritized in Complete Streets (Gregg and Hess 2019). Further, there is an existing literature gap in the integration of flood mitigation in Complete Street design toward the accomplishment of the fundamental goals of safety and access. Transportation systems require a new tool for GSI implementation that supports Complete Street goals under climate change and social equity considerations. GSI is a modular, scalable infrastructure solution that can be cost-effectively integrated into problem locations in the transportation network for environmental, social, and economic co-benefit. This research addresses this gap through the conceptualization of Complete Streets designed with an adaptable GSI kit-of-parts.

1.2. Community engagement: reaching diverse user groups during COVID

Street design has traditionally favored cars in design considerations. The COVID pandemic has underlined the important role streets can play in providing safe and healthy outdoor social spaces across users and modes (Sharifi, 2020). Streets are critical social infrastructure (Kuiper et al., 2020). Adaptive streets that are complete streets and provide this important social infrastructure, design for a diverse set of public interests. As Lisa Abendroth and Bryan Bell outline, there are five principles when engaging in public interest design: (1) advocate with those who have a limited voice in public life, (2) build structures for inclusion that engage stakeholders and allow communities to make decisions, (3) promote social equity through discourse that reflects a range of values and social identities, (4) generate ideas that grow from place and build local capacity, and (5) design to help conserve resources and minimize waste (Abendroth and Bell, 2015, 13). The engagement work undertaken in this bicycle boulevard design followed these five principles across engagement with six neighborhoods and the resulting proposed bicycle boulevard design. Design teams sought out community members beyond the obvious stakeholder neighborhood leaders, created a variety of activities to solicit input and inclusion, focused on design moments that strengthened existing assets in the community, and created budgets for their kit-of-parts that efficiently used city and neighborhood resources.

The initial COVID lockdown occurred midway in the community engagement process of this project. The work endeavored to use a tactical urbanism and experimentation methods to ground-truth design approaches for each unique situation. This process includes five steps: (1) empathize, (2) define, (3) ideate, (4) prototype, and (5) test (Lydon, 2015). Although this process was followed, the testing of various kit-of-parts prototypes shifted from live street interactions with the community to online surveys and social media. Community needs also changed and amplified as a result of COVID as an awareness of the importance of streets as outdoor social spaces for safe and meaningful community interaction increased. Thus, in addition to changes in community engagement modes, designs also refocused as a result of the COVID pandemic. COVID changed approaches to design and community engagement across the design disciplines – creating greater limitations and also greater incentives and urgency to the work (Cabral et al., 2020).

2.0 METHOD

2.1. Study area: street history and recent policies

This research designed a 6-mile bicycle boulevard across Tucson, Arizona (FIGURE 1). Tucson experiences annual events of severe flooding and has recently adopted a Complete Streets policy and a Green Stormwater Infrastructure fee. Located in the Sonoran Desert, Tucson is subject to fluctuations in daily volumes and seasonal patterns of rainfall. Tucson has a light (roughly December through February) and heavy (roughly July through September) rainy season joined by intense stretches of heat and dryness.

Tucson has a unique stormwater management history. The majority of the urban center of Tucson does not currently have storm water piping. Streets were designed to carry the heavy rain flows that occur during the winter and monsoon seasons to washes throughout the city. Over time, the city grew and greatly shifted its majority pervious land cover to impervious. Tucson has the highest yearly extreme storm count across Western US Metropolitan Statistical Areas (Bakkensen and Johnson, 2017). These urban water extremes affect citizens directly and disproportionately. Tucson averages \$9.5 million in property losses each year from flooding in the city center where stormwater infrastructure was historically not installed, predominately in lower income areas (Bakkensen and Johnson, 2017).

To address these issues, the County and City have worked over the last decade to collaboratively develop policies to address current flooding issues and retrofit Tucson with a network of GSI. The City of Tucson established a Green

Streets policy in 2013 which requires that the department of transportation design new upgraded streets that convey stormwater into GSI features. Additionally, a goal of covering streets with a 25% tree canopy is stated. In 2019, the City passed a Complete Streets policy with the goal of ensuring safety and accessibility to the transportation network to a diversity of citizens. In spring 2020, the Tucson City Commissioners adopted a new GSI fee, previously absent from community water bills. In contrast to the two existing fees for potable water and sewer, this third fee funds the planning and construction of a decentralized GSI system throughout the city. The goal of using GSI in Tucson is to reduce areas of localized flooding and improve co-benefits such as increased shade, reduced heat island effect, and decreased nonpoint source pollution throughout the city. These three recent policies support the implementation of efficient and connected transportation and stormwater networks, like the funded bicycle boulevard which is the focus of this research.

BICYCLE BOULEVARD FLOODING

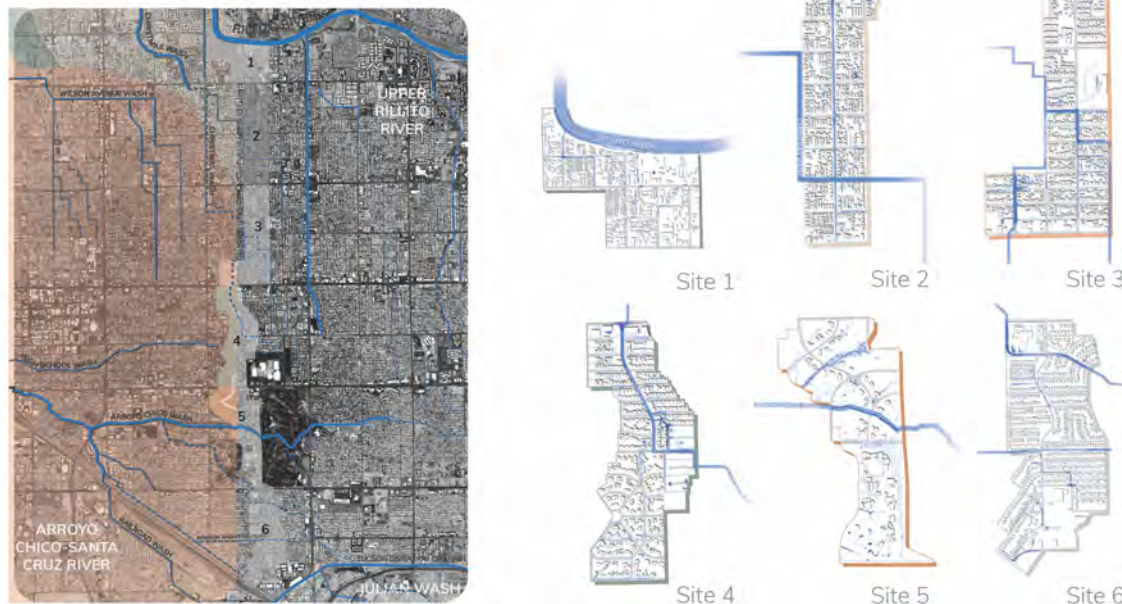

Figure 1: Map of bicycle boulevard and research-design area (Credit: ARCH 451a studio, 2020)

2.2. Public-academic partnership

This paper examines this Tucson case study where a public-academic partnership was formed between neighborhood associations, Tucson Department of Transportation planners, County Flood Control District hydrologists, and the University of Arizona (UA). Led through an UA upper-level design studio, the partnership used spatial mapping, quantitative analysis, hydrological modelling, and design inquiry to create a six-mile bicycle boulevard that is slated to be constructed from the northern to southern city limits, passing through the largest municipal park. The City of Tucson sponsored the research studio course. The project designed the bicycle boulevard with a kit-of-parts of context-specific GSI to provide localized and network benefits including flood reduction, shaded pedestrian and bicycle protected paths, increased safety measures and traffic calming, and neighborhood place-specific social areas. The six design teams completed research across the six areas to design the bicycle boulevard as an adaptive street. Research included community engagement activities, pedestrian and bicycle counts, speed studies, and hydrologic and hydraulic modelling unique to each of six areas along the bicycle boulevard informed which if these kit-of-parts was used where along the length.

2.3. Hydrologic and hydraulic modelling of the street network

As a part of this public-academic partnership, Pima County Flood Control completed hydrological modeling across the 6-mile bicycle boulevard design. This modeling was completed with Flo-2D, a fluid dynamics software that combines hydrology and hydraulics to model flooding conditions. Student were provided with three iterative flood analyses to inform their designs: a baseline case for their site, flow reduction and storage capacities for their mid-term design, and flow reduction and storage capacities for their final design.

2.4. Community engagement method and COVID

The six design teams completed multiple community engagement activities to understand and prioritize local needs and desires for the bicycle boulevard. Design teams were each required to follow the same sequence of community engagement meetings and activities. This sequence ensured communication across all levels of existing community organizations. First, design teams meet with city departments and local ward offices and corresponding city

commissioners for their area. Second, design teams completed a speed study and bicycle and pedestrian counts for their area at a key intersection at three times of day. This gathered data also contributed to the expansion of the local bicycle and pedestrian count database for key streets and intersections in Tucson, which is run through the Pima Association of Governments. Thirdly, design teams met with neighborhood association(s) for their area and completed an asset and challenges assessment. At this meeting, design teams also shared the gather quantitative assessment data of speed, bicycle and pedestrian counts at the key neighborhood intersection. Fourthly, design teams presented an initial design proposal at midterm review to city officials, neighborhood leaders, and design critics. Fifthly, based on initial research and midterm feedback, design teams devise and completed an experiment to gather more specific feedback on implications of their design. As a methodology for these live urban experiments, design teams were originally planning to use concepts such as “tactical urbanism” where low-cost, scalable interventions are used to catalyze change. However, as COVID hit weeks before these experiments were going to be rolled-out, design teams had to devise new methodologies that were virtual and could answer the same or similar questions. Sixthly, using the received feedback from the experiment, design teams finalized and presented the complete design to the community partners that were engaged throughout the process. City and County administrators, neighborhood representatives, and engaged citizens attended the virtual and recorded presentation. Lastly, one design team was selected to continue the implementation work for all six areas through a summer internship with the city department of transportation and mobility.

3.0 RESULTS

3.1. Kit-of-parts. Approach for adaptive streets across diverse neighborhoods

Along the 6-mile bicycle boulevard, the street moved through six different neighborhoods with varying safety, pedestrian comfort, social wellbeing, and ecological adaptation challenges. Kit-of-part sets were designed to address each of these four main topical concerns for the variety of conditions that occurred across the six diverse areas. A kit-of-parts adaptive street design approach implemented city-wide was a cost-effective and practical long-term maintenance solution for the city. By comparison, one-off street designs that are completely different for each neighborhood create thousands of unique maintenance issues and expensive construction for thousands of unique details. Kit-of-parts addressed at least one of the four main topical concerns and often overlapped with multiple concerns. For example, the safety kit-of-parts included traffic circles, bump out basins, and signage. The traffic circles and basins also were found in the topical areas of ecological adaptation for flood mitigation and the pedestrian comfort to provide shade. The total kit-of-parts forms a comprehensive menu of multi-benefit design solutions to the variety of conditions and concerns along the cross-city bicycle boulevard throughout varied neighborhoods with differing equity issues. The six design teams used engagement activities to identify which of these kit-of-parts were most appropriate for the neighborhood conditions and to refine them for their area.

3.2. Neighborhood results: six engagement and design approaches

Area 1 was an industrial area that mainly had curbless and inverted crowned streets. As this area bordered the Rillito River, it was the deposit point for the urban flooding starting in area 4 and flowing into the Rillito River. In addition to the pedestrian and bicycle counts and speed study (there was a high incidence of speeding in this area), the design team completed an online survey with the two involved neighborhood associations and many dozens of area businesses. The curbless street were desirable for the industrial businesses for versatility of large trucks and equipment parking. On the other hand, there was a heat island and lack of shade concern for bicyclists and pedestrians using the cross-city bicycle boulevard. Given the proximity to the river, there was an ecological concern that storm water was naturally treated through basins before reaching the river habitat. Students took these community concerns and designed a series of basins to address critical points in the stormwater flow and chronically flooded areas (FIGURE 2). One road was closed for pedestrian and bicycle safety and shade was added.

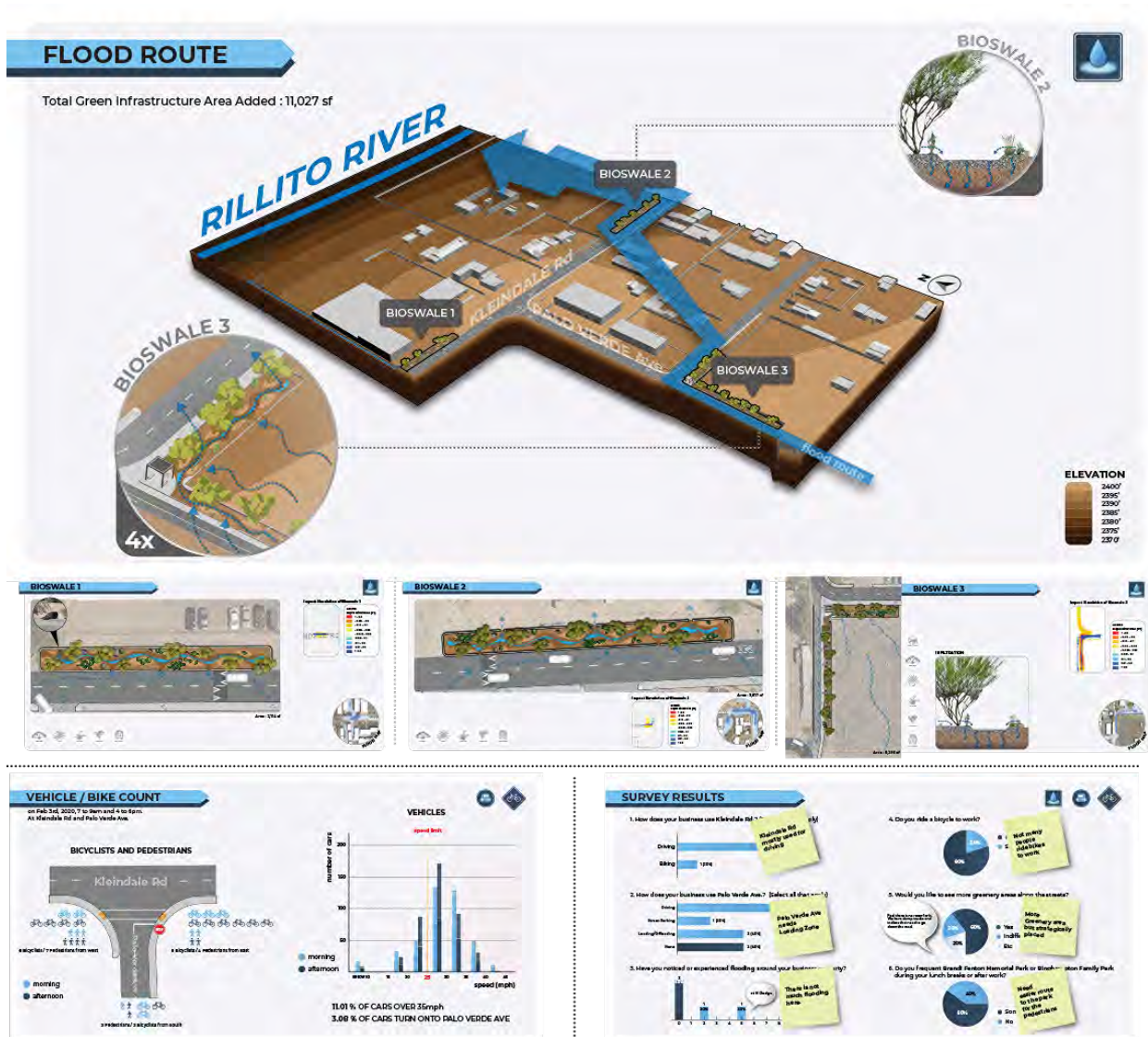

Figure 2: Area 1 Bicycle Boulevard Engagement and Kit-of-Parts (Credit: ARCH 451a studio, 2020)

Area 2 was a residential area with mainly inverted crown streets. There were four smaller neighborhood associations that comprised this lower income area. In addition to the pedestrian and bicycle counts and speed study, the design team attended neighborhood association meetings and administered an online survey to all community groups. The survey results revealed a great frustration with the amount of flooding along the bicycle boulevard street and some safety and speed concerns. In response to the expressed flooding and safety concerns, traffic circle basins were added at every other intersection along the street and corner basins were added throughout.

Area 3 was a residential neighborhood that was middle income and included a large neighborhood high school. The street was largely inverted and had curbs. In addition to the pedestrian and bicycle counts and speed study, the design team attended neighborhood association meetings and sent out an online survey to the neighborhood association (FIGURE 3). Due to the neighborhood high school, there was a lot of pedestrian and bicycle activity noted both in the early count studies and also expressed at the neighborhood association meetings and online survey. To address the expressed safety, ecological, multimodal, and social needs, the design team implemented a set of median and traffic circle basins on the inverted crowned segment of the street and bump out basins when the bicycle boulevard turned into a crowned street.

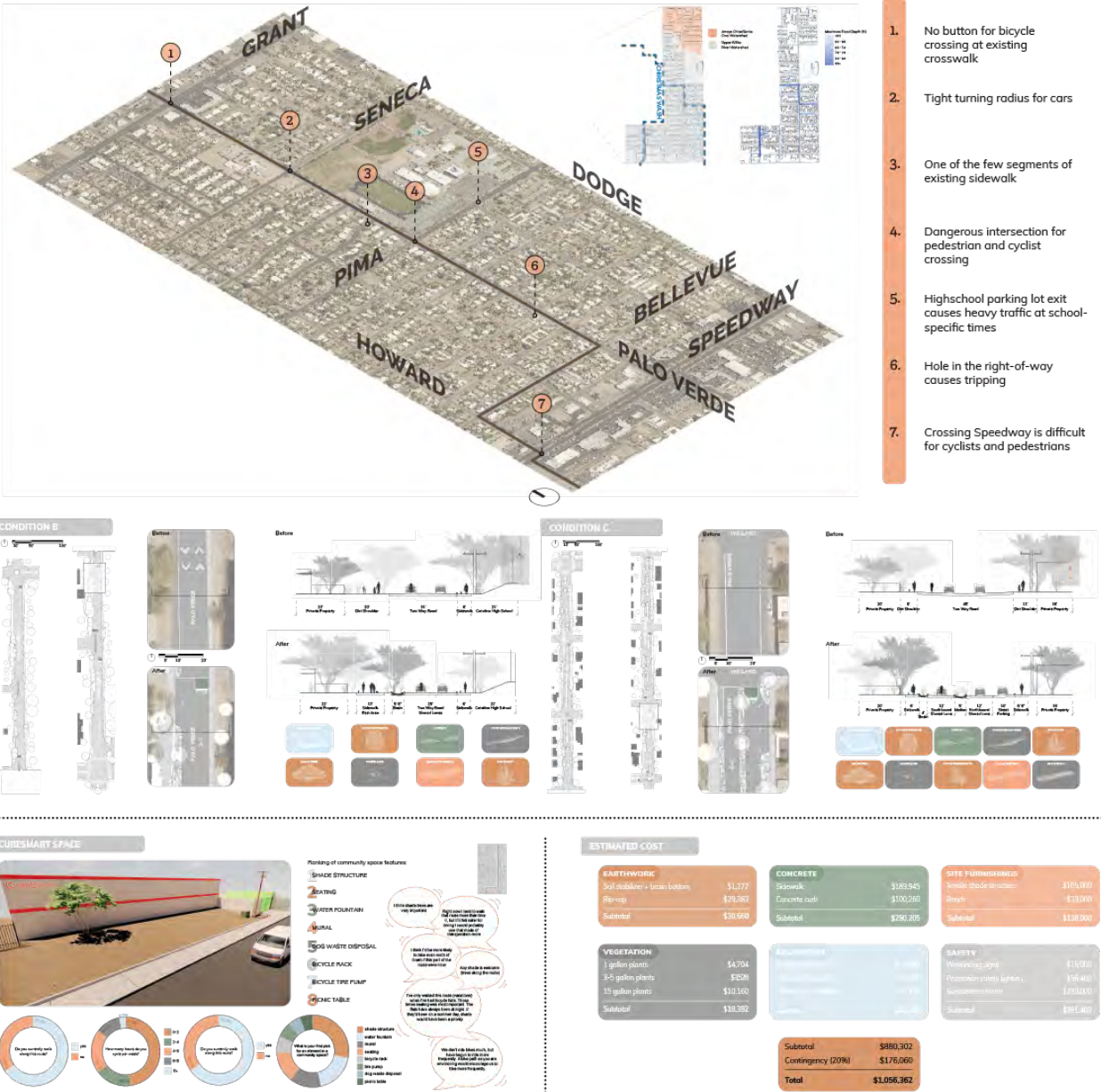

Figure 3: Area 3 Bicycle Boulevard Engagement and Kit-of-Parts (Credit: ARCH 451a studio, 2020)

Area 4 spanned a commercial area buffer and middle income residential neighborhoods. In addition to the pedestrian and bicycle counts and speed study, the design team attended neighborhood association meetings and created a facebook page which asked community members to take photos of good or bad examples of street design. The design team administered this facebook page and solicited community dialogue during COVID from these posted photos and comments (IMAGE 4). This was an effective way to engage a wide section of the community both visually and through writing. It was easier to understand community design desire through seeing the photos and situations they selected. In response to the online engagement, the design team used traffic circle and median basins along the inverted crowned street and incorporated many social spaces along the bicycle boulevard length.

RESILIENT CITY
Physical, Social, and Economic Perspectives

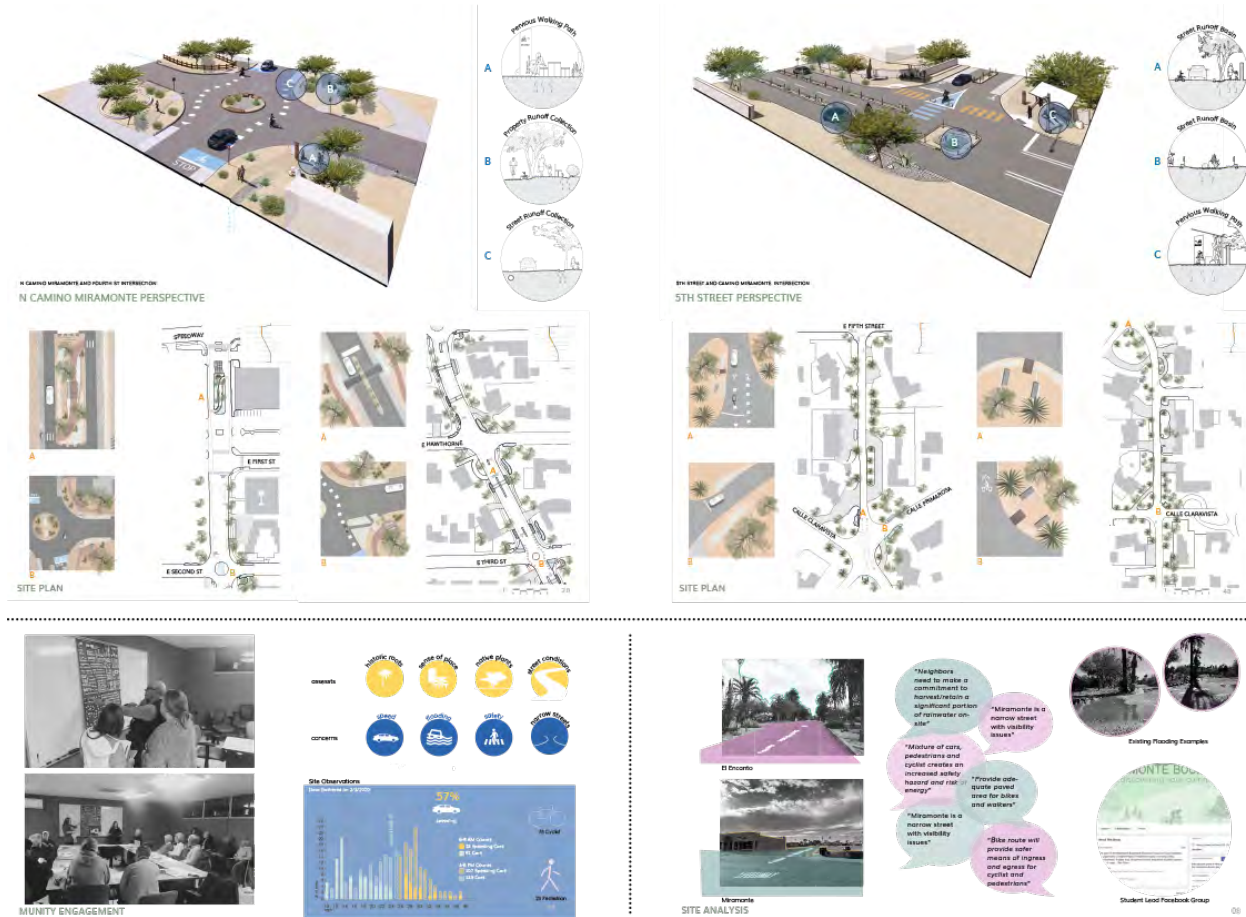

Figure 4: Area 4 Bicycle Boulevard Engagement and Kit-of-Parts (Credit: ARCH 451a studio, 2020)

Area 5 included one of the wealthiest neighborhoods in the city which has narrow, “naked” streets. This area also included the largest municipal park in the city. The design team solicited comments through a comment box station along one of the main pedestrian and bicycle thoroughfares in the park. The box asked for feedback on desired social amenities and other safety, ecological, and multimodal concerns. The design team implemented more specialized crossings, more impervious paving, and expanded social spaces.

Area 6 was a residential area that was lower income and considered to be a food desert. The streets were crowned. Design teams addressed multimodal concerns expressed in an online neighborhood survey and collage activity through adapting existing bus stops for expanded social space and shade. Corner and roadside basins were implemented throughout the neighborhood to address safety, multimodal, and ecological flooding concerns.

CONCLUSION

The final bicycle boulevard designs used a kit-of-parts approach to propose an adaptive street model that addressed chronic ecological and social equity issues along its length. Adaptive elements reduced flooding, shaded pedestrian and bicycle protected paths, increased safety measures and traffic calming, and diversified neighborhood place-specific social areas. The paper argues that context-specific, adaptive designs can be systematically created through community engagement processes tailored to the diverse communities along the extents of a city street. The six-mile bicycle boulevard design is slated to be constructed from the northern to southern city limits. The kit-of-parts of adaptive street design interventions was presented to the city in an interactive PDF book for future implementations.

ACKNOWLEDGEMENTS

The students of Architecture 451a included thirteen undergraduate Bachelor of Architecture students. Thanks to all the students for their hard work and creative energies.

REFERENCES

- Abendroth, L. M., & Bell, B. (Eds.). (2015). *Public interest design practice guidebook: SEED methodology, case studies, and critical issues*. Routledge.
- Bakkensen, L. and R. Johnson (2017) *The Economic Impacts of Extreme Weather: Tucson and Southern Arizona's Current Risks and Future Opportunities*. Making Action Possible for Southern Arizona.
- Cabral, A., Freeman, H., Sachs, R., Schmidt, T., & Gamez, J. (2020). DIY in Pandemic Times: Design Leadership During COVID-19. *Technology| Architecture+ Design*, 4(2), 140-143.
- Dodds, A. (2017). For the greater good: A complete streets approach can benefit low-income communities. *Roads & Bridges*, 55(8).
- Environmental Protection Agency. *What is Green Infrastructure?* 2020. Accessed 19 May 2020. <https://www.epa.gov/green-infrastructure/what-green-infrastructure>
- Gregg, K., and Hess, P. (2019). Complete streets at the municipal level: A review of American Municipal Complete Street Policy. *International journal of sustainable transportation*, 13(6), 407-418.
- Kuiper, J. F., Coleman, A., James, O. A., Sharma, M., & Dailey, D. (2020). *Reinventing Social Infrastructure: The impact of COVID-19 on streetscapes of today's cities*.
- Lydon, M., & Garcia, A. (2015). A tactical urbanism how-to. In *Tactical urbanism* (pp. 171-208). Island Press, Washington, DC.
- NACTO. *Urban Street Design Guide*. 2020. Accessed 19 May 2020. <https://nacto.org/publication/urban-street-design-guide/streets/>
- Riverón, N. (2019). *The Best Complete Streets Policies of 2018*.
- Sharifi, A., & Khavarian-Garmsir, A. R. (2020). The COVID-19 pandemic: Impacts on cities and major lessons for urban planning, design, and management. *Science of The Total Environment*, 142391.
- US Department of Transportation. *Complete Streets*. 2020. Accessed 19 May 2020. <https://www.transportation.gov/mission/health/complete-streets>
- Wuebbles, D. J., et al. "Climate Science Special Report: Fourth National Climate Assessment." US Global Change Research Program: Washington, DC, USA (2017).

Integrating Biophilic, Net-Positive, and Resilient Design: A Framework for Architectural Education

Mary Guzowski¹

¹University of Minnesota, Minneapolis, MN

ABSTRACT: This paper explores how a biophilic framework can be overlaid on a net-positive-energy architectural design studio to expand students' definition of net-positive to include broader "positive benefits" - not only for human health, well-being, and resilience, but also for other species, ecological systems, and the planet itself. The paper considers some of the ecological challenges of today's design education; provides an overview of the biophilic frameworks considered in the studio; explores potential overlaps between a biophilic framework, net-positive energy, and resilient design; and provides example studio content and student work. Conclusions highlight key issues to support the integration of a biophilic framework in a net-positive design studio. While this studio focused on net-positive energy, the application of a biophilic framework is relevant for any regenerative design or "net-positive" topic such as net-positive water, net-positive waste, or net-positive materials. A biophilic framework can transcend the site and building design scales to inform design in the neighborhood, community, city, region, and beyond.

KEYWORDS: Biophilic Design, Net-Positive Energy, Net-Positive Design, Resilient Design

INTRODUCTION

In their essay "The Nature of Positive," Pamela Mang and Bill Reed reframe the traditional focus on energy to consider the ecological, community, and place-based potential and "added value" of "net-positive":

How would ecological thinking shift the way building industry professionals think about adding value to ecological systems?... instead of starting with the building and what surplus it can generate, a designer would start by asking what ecological services have been disabled in this place and what roles are missing that enabled those services in the past. Instead of asking how to deploy any excess in order to add value, a designer would ask what is the role of this particular project and the land it occupies in the larger systems of its place. How does its role enable other entities to play their roles? What are the patterns of relationships that need to be established or re-established between the building, its occupants and its community to enable their positive roles reciprocally? And then, what specific 'positives' can this project offer and/or catalyze (Mang and Reed, 2014, 9)?

This paper explores how a biophilic framework was overlaid on a seven-week net-positive-energy graduate architectural design studio to expand students' definition of net-positive to include broader "positive benefits" - for not only human health, well-being, and resilience, but also for other species, ecological systems, and the planet itself. As one of four parallel "Net-Positive Studios," the curriculum agenda for this cohort of instructors and students was to investigate net-positive design strategies, methods, tools, and metrics at the site and building scales that reduce operational energy and greenhouse gas (GHG) emissions. In addition to the required curriculum agenda, this studio introduced a biophilic framework to explore how net-positive energy strategies can be coupled with other "positive benefits" to support biodiversity, habitat, living systems, and climate change response.

The paper considers some of the ecological challenges of today's design education; provides an overview of the biophilic frameworks considered in the studio; explores potential overlaps between a biophilic framework, net-positive energy, and resilient design; and provides example studio content and student work. Conclusions highlight key issues to support the integration of a biophilic framework in a net-positive studio. While this graduate design studio focused on net-positive energy, the application of a biophilic framework is relevant for any regenerative design or "net-positive" topic such as net-positive water, net-positive waste, or net-positive materials. A biophilic framework can also transcend the site and building design scales, which were the focus of this studio, to inform design at the scales of the neighborhood, community, city, region, and beyond.

1.0 DESIGN CHALLENGES & BIOPHILIC DESIGN FRAMEWORKS

1.1 Design Education in the Age of the Anthropocene

As design educators and students, how might we remain hopeful and assured of the role and relevance of design in this time of global pandemics; ever increasing GHG emissions; unprecedented flooding, fires, and drought; loss of biodiversity, and all of the other of urgent ecological issues that require healthy, resilient, and adaptive design solutions for the benefit of all life? Over forty years ago, limnologist Eugene Stoermer coined the term "Anthropocene" to suggest that we have entered a new geological epoch that reflects our ever-growing impact on planetary systems. The concept of the "Anthropocene" gained popularity twenty years ago when Stoermer and Nobel Prize winning meteorologist and atmospheric chemist Paul Crutzen published their essay "The Anthropocene" in the *Global Change Newsletter* (Crutzen

and Stoermer, 2000, 17). Ecosystems scientist Yadvinder Malhi suggests that this term challenges humans to reconsider our relationship to nature and current ecological dilemmas:

The Anthropocene has become a scientific and cultural zeitgeist, a charismatic mega-category emerging from and encapsulating elements of the spirit of our age.... Much of the potency of the term results from its embracing and stimulating new thinking across so many intellectual disciplines and cultural spheres...in trying to define the Anthropocene we try to define the deeper meaning and context of the modern environmental challenge – and the relationship between the human and the natural (Malhi, 2017, 78-79).

Biophilic design frameworks aim toward the common goals of supporting the health and well-being of the environment and ecological systems; celebrating the unique qualities of place; and responding to the dynamic and changing forces and conditions of the Anthropocene. The *Resilient Design Institute* (RDI) emphasizes the versatility and potential overlaps of resilient design with other biocentric frameworks and concepts:

Resilience is the capacity to adapt to changing conditions and to maintain or regain functionality and vitality in the face of stress or disturbance.... Resiliency is not any single solution, concept or perspective. Resiliency is a multifaceted lens which balances proactivity and reactivity to inform solutions to disruptions. Resilient Design is taking that lens and using it to rethink the built environment (RDI, 2021).

The studio's integration of biophilic and net-positive-energy design considered whether biophilic strategies can expand today's predominantly anthropocentric lens on architectural design to embrace a life-focused biocentric perspective? Can the life enhancing potential of a biophilic framework be further strengthened when integrated with select net-positive and resilient design strategies? This studio investigated why, how, and in what ways might biophilic, net-positive, and resilient design intersect to benefit all life.

1.2. Biophilic Design Foundations and Frameworks

The seven-week Biophilic Net-Positive Design Studio is one of four parallel “net-positive studios” in the second year of the three-year M.Arch Program at the School of Architecture at the University of Minnesota. This studio is followed by a seven-week Integrated Design Studio, in which the student cohort stays together and continues to work with a second instructor to focus on construction, systems integration, and detailing. The net-positive studio introduces the design strategies, methods, and tools to support net-positive energy performance goals and reductions in greenhouse gas emissions in building operations while meeting the highest standards for design excellence. Students are not required to achieve net-positive energy, but rather to define their individual project energy and GHG emissions goals and to consider design trade-offs to meet integrated design aspirations.

In the first phase of the Biophilic Net-Positive Studio, students explored definitions and the history of biophilic design. In reviewing different frameworks for biophilic design, they considered how it is an ancient way of designing, with many vernacular and bioregional and bioclimatic lessons from across time and cultures. They considered early definitions and the transformation of concepts in time, including the term “biophilia”, which was introduced by psychologist Erich Fromm in the 1960s and popularized in the 1970s in his book *The Anatomy of Human Destructiveness*: “*Biophilia is the passionate love of life and of all that is alive; it is the wish to further growth, whether in a person, a plant, an idea, or a social group* (Fromm, 1973, 365). Biologist and naturalist E.O. Wilson popularized the more common anthropocentric concept by proposing the “Biophilia Hypothesis,” which suggests there is an “*innate emotional affiliation of human beings to other living organisms* (Wilson, 1984, 1).” Although the concept of “biophilia” was translated into a design framework in the 1980's, only recently has biophilic design begun to gain real popularity with the publication of design frameworks by Kellert, Heerwagen, and Mador, (Kellert, et al., 2008); Kellert and Calabrese (2015) and Terrapin Bright Green (Terrapin, 2014). Students also explored other resources such as the *Living Building Challenge*, *Fitwel System*, and *WELL Building Standard* (LBC, 2021; Fitwell, 2021; WELL, 2021).

Students compared the similarities and distinctions in biophilic frameworks, including the first set of design strategies, entitled *Biophilic Design Elements & Attributes*, which was developed in 2008, includes six “elements” and seventy related “attributes” (Kellert et al., 2008, 15). In 2009, biophilia was first cited as a design topic under “health”, in the International Living Futures Institute (ILFI) *Living Building Challenge* (LBC) 2.0 standard, which continues today under the “beauty + biophilia imperative 19” in *LBC 4.0*. In 2014, Terrapin published the *14 Patterns of Biophilic Design*, explaining that the framework of patterns arose from collaborations with many biophilic design experts:

The patterns have been developed through extensive interdisciplinary research and are supported by empirical evidence and the work of Christopher Alexander, Judith Heerwagen, Rachel and Stephen Kaplan, Stephen Kellert, Roger Ulrich, and many others....

These 14 patterns have a wide range of applications for both interior and exterior environments, and are meant to be flexible and adaptive, allowing for project-appropriate implementation (Terrapin, 2014, 4).

Terrapin added a fifteenth pattern entitled “Awe” in 2020 (Brown and Ryan, 2020, 5). In 2015, Kellert and Calabrese published a simplified framework entitled *Biophilic Experiences & Attributes* that include only three “categories” with twenty-four attributes (Kellert and Calabrese, 2015, 10). ILFI has recently developed supplemental resources to support Kellert et al. (2008), including Amanda Sturgeon's book *Creating Biophilic Buildings* (Sturgeon, 2017) and the *Biophilic Design Guidebook* (ILFI, 2018). In reviewing these resources during the first phase of the studio, it became clear that biophilic design is not only about human health and well-being but rather, as framed by Fromm, it is consistent with broader ecological agendas found in net-positive, resilient, and regenerative design frameworks. The first phase of the studio also touched on the body of scientific research that has developed over the past several decades that demonstrates the physiological and psychological benefits of human contact with nature, such as gardens, views, daylight, materials, and nature imagery (Browning and Ryan, 2020), along with the benefits for non-human species and the ecological well-being of the planet. These foundational studies established biophilic design within a larger historic and ecological context and its potential role in integrating with the nature and natural forces of place and passive and climate-based design strategies.

2.0 COMPARING & TRANSLATING BIOPHILIC DESIGN FRAMEWORKS

2.1 Comparing Biophilic and Bio-Inspired Design Frameworks

In the next phase of the studio, students compared three biophilic frameworks to discern different emphases, strengths, and limitations. Kellert et al.'s 2008 *Biophilic Design Elements & Attributes* provides a robust list of potential strategies to integrate biophilic issues across design topics and scales. The seventy “attributes” include a smorgasbord of design strategies. While potentially overwhelming, it is important to note that even the identified “seventy attributes” only begin to illustrate the many ways in which the six “elements” could be interpreted and should not be viewed as exhaustive. In contrast, Terrapin’s 2014 *14 (15) Patterns* provides a curated list of biophilic topics that are left to the designer to interpret. The *15 Patterns* capture, in a concise manner, the essential issues found in Kellert et al.’s two frameworks and provide a simplicity that supports ease of design application. Kellert and Calabrese’s 2015 *Experience & Attributes* is framed from an anthropocentric perspective that emphasizes the direct and indirect human experiences of nature, space, and place; however, the underlying design intention is for the benefit of human and non-human species and natural systems. Given its clarity and flexibility in design interpretation, Terrapin’s *15 Patterns* was selected as the primary biophilic design framework for the studio (Table 1). As students moved into the design phase, Terrapin’s *15 Patterns* were integrated with the “Energy Hierarchy” as a net-positive design framework, with a sequence of integrated biophilic net-positive design exercises developed to consider mutual design benefits (discussed in Section 3.1-3.4).

2014/2020: Terrapin Bright Green 14/15 Patterns of Biophilic Design		
Nature in space	Nature Analogues	Nature of Space
<ol style="list-style-type: none"> 1. Visual connection with Nature 2. Non-Visual Connection with Nature 3. Non-Rhythmic Sensory Stimuli 4. Thermal and Air Flow Variability 5. Presence of Water 6. Dynamic and Diffuse Light 7. Connection with Natural Systems 	<ol style="list-style-type: none"> 8. Biomorphic Forms and Patterns 9. Material Connection to Nature 10. Complexity and Order* 	<ol style="list-style-type: none"> 11. Prospect 12. Refuge 13. Mystery 14. Risk/Peril 15. Awe <p><i>NOTE: Pattern 15 Awe was added in 2020.</i></p>

Table 1: Terrapin’s 15 Patterns of Biophilic Design. Source: (Terrapin Bright Green, 2020)

2.2. Biophilic Design & A Biocentric Built Environment

Select readings and resources enabled students to explore potential overlaps with other ecological design frameworks. In their 2008 seminal text *Biophilic Design*, Kellert, Heerwagen and Mador clarify an ambitious bio-inspired design intention:

Unfortunately, the prevailing approach to design of the modern urban built environment has encouraged the massive transformation and degradation of natural systems and increasing human separation from the natural world.... The new paradigm is called here ‘restorative environmental design,’ an approach that aims at both a low-environmental-impact strategy...and a positive environmental impact or biophilic design approach that fosters beneficial contact between people and nature.... Biophilic design is, thus, viewed as the largely missing link in prevailing approaches to sustainable design (Kellert et al., 2008, 5).

Biophilic design could be viewed as an overarching biocentric perspective that embraces principles from a variety of frameworks, such as resilient, regenerative, restorative, biomimetic, and net-positive design (Figure 1).



Figure 1: Biophilic design as an organizing strategy to overlay with other ecological design frameworks. Source: (Author, 2021)

Students considered how biophilic design might also connect with other “bio-inspired” design perspectives. A biophilic framework might overlap with a combination of bio-inspired design lenses, including biomimetic, bioclimatic, bioregional, and biomorphic, among others (Figure 2). For example, The *Resilient Design Strategies at the Building-Site Scales* (RDI, 2021) can overlay many of the *15 Patterns* of Biophilic Design (Table 2), particularly in the “Nature in Space” category, which are directly related to resilient design strategies to reduce dependency on fossil fuels while increasing passive survivability, on-site renewable energy, access to local water and waste resources, and local material sources.

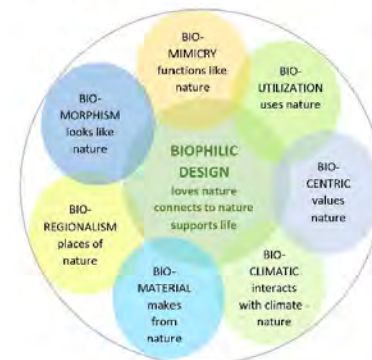

Figure 2: Biophilic design as a framework for other bio-related design principles. Source: (Author, 2021)

While not the focus of this studio, some students explored net-positive water, waste, or materials, including resilient design approaches to harvest and process water and waste on site, among other biophilic, net-positive, and resilient material intersections. The resonance between biophilic and biomimetic design can also be found in the Biomimicry Institute’s (BI) *10 Patterns of Nature* (Table 2) (BI, 2021). Overlaps can be fostered in the “Nature in Space” and “Nature Analogue” patterns through passive strategies, habitat and biodiversity, and on-site water, waste, and regional materials. The “Nature of Space” patterns are indirectly related to resilient and biomimetic design by experiencing time, weather, seasons, and atmospheric conditions of place.

RESILIENT DESIGN Resilient Design Institute Strategies for Resilient Design	BIOPHILIC DESIGN Terrapin 15 Patterns		
BUILDING & SITE SCALES See Resilient Design Institute https://www.resilientdesign.org/resilient-design-strategies/	Nature in Space	Nature Analogues	Nature of Space
1. Design for severe storms, flooding, wildfire, and other climate impacts	X	X	
2. Locate critical systems to withstand flooding and extreme weather	X		
3. Model design solutions based on future climatic conditions	X	X	
4. Passive survivability: reliance on passive heating and cooling	X		
5. Durable buildings: rainscreens, windows, finishes	X	X	X
6. Beautiful buildings to love and maintain	X	X	X
7. Reduce dependence on complex controls; manual overrides	X	X	
8. Onsite renewables	X		
9. Water conservation	X		X
10. Redundant water supplies	X		
11. Options for human waste disposal: non-operating municipal system	X		
12. Locally available products and skills	X	X	
13. Products and materials that will not offgas or leach hazardous substances		X	
14. Rely on vernacular design practices	X	X	X
15. Provide redundant electric systems; back-up power	X		
16. On-premises non-perishable food supply		X	

BIOMIMETIC DESIGN Biomimicry Institute: 10 Patterns of Nature	BIOPHILIC DESIGN Terrapin: 15 Patterns		
BUILDING & SITE SCALES See Biomimicry Institute: http://biomimicry.org	Nature in Space	Nature Analogues	Nature of Space
1. Nature uses only the energy it needs and relies on freely available energy	X		
2. Nature recycles all materials	X	X	
3. Nature is resilient to disturbances	X	X	
4. Nature tends to optimize rather than maximize	X	X	X
5. Nature provides mutual benefits	X	X	X
6. Nature runs on information	X	X	X
7. Nature uses chemistry and materials that are safe for living beings	X	X	
8. Nature builds using abundant resources, incorporating rare resources only sparingly	X	X	
9. Nature is locally attuned and responsive	X	X	X
10. Nature uses shape to determine functionality	X	X	X

Table 2: Example of potential overlaps with Terrapin's 15 Patterns of Biophilic Design, Resilient Design Strategies, and Biomimicry Patterns of Nature. Source: (Author, Resilient Design Institute, Biophilic Design Institute, and Terrapin, 2021)

2.3. Integrating Biophilic, Net-Positive & Resilient Design

After establishing some fluency in the principles of biophilic and other bio-inspired design frameworks, a series of iterative exercises were introduced to investigate the potential qualitative and quantitative benefits of a biophilic approach to net-positive design. The program brief for the studio was an 8,000-10,000 square foot student health facility located on campus, with the health-related program and activities for the site and building defined by individual students. All were asked to consider how select biophilic patterns might inform health and well-being at the site, building, envelope, and room scales, while addressing current ecological challenges and dynamic forces of climate change.

The studio explored potential design overlaps and integration of Terrapin's three categories for the 15 Patterns and how they might be translated and integrated with net-positive energy and resilient solutions for ecological and health benefits. To avoid a checklist approach to the biophilic design framework, students were asked to select three to five relevant and impactful patterns to inform design, with at least one pattern from each of the three categories of the 15 Patterns: 1. Nature in Space, 2. Nature Analogues, and 3. Nature of Space. The following discussions illustrate potential biophilic net-positive energy design issues, exercise topics and methods, assessment tools, and related examples of student work. The three categories are discussed in sequence; however, students were asked to "scale-jump" and move back and forth in an integrated way between the three categories and related topics during the 7-week studio.

The Biophilic Net-Positive Studio has a site and passive design focus with a charge for students to develop a schematic design proposal that would further consider construction, systems, and details in the following seven-week Integrated Design Studio. The organization of the biophilic net-positive assignments is illustrated in Figure 3.

Figure 3: Right: Sequence of Biophilic Net-Positive Exercises: 7-weeks Module A; followed by Integrated Design Studio: 7-weeks Module B.

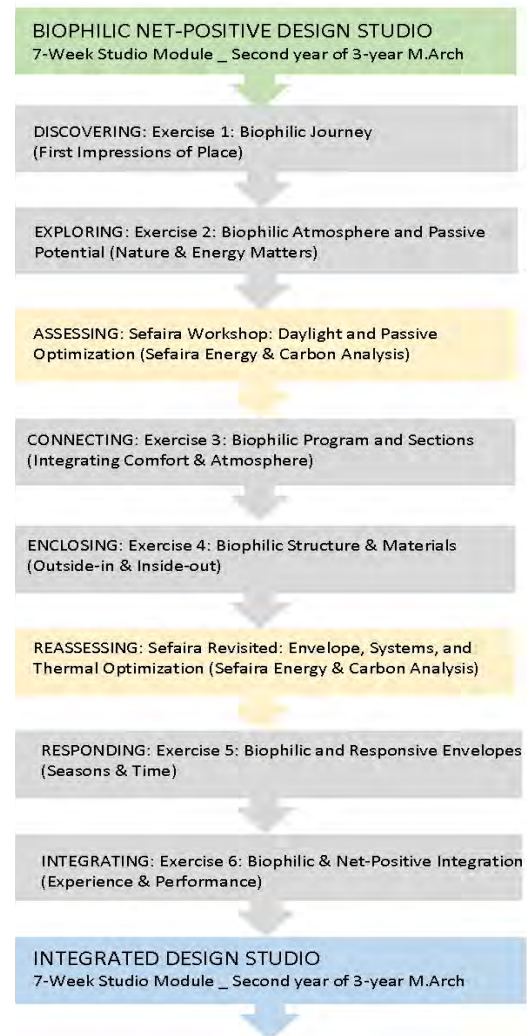

3.0 NATURE IN SPACE, NATURE ANALOGUE & NATURE OF SPACE PATTERNS

3.1 Nature in Space Patterns and the Energy Hierarchy

Terrapin’s “Nature in Space Patterns” explore relationships to place, time, seasons, weather, environmental forces, and natural systems (Table 3). The seven corresponding patterns include visual and nonvisual connections with nature, light, and dynamic forces such as water, air, thermal variability, and natural systems. Based on program approaches and design intentions, students explored select patterns that could provide biophilic, net-positive, and resiliency opportunities.

Students were asked to balance qualitative experiences of site and place with quantitative assessment of thermal and luminous comfort, energy consumption, and GHG emissions. Architecture 2030’s “energy hierarchy” and energy targets were used as the net-positive framework for the integration of passive design, high performance systems, and renewable energy (Figure 4) (Architecture 2030, 2019).

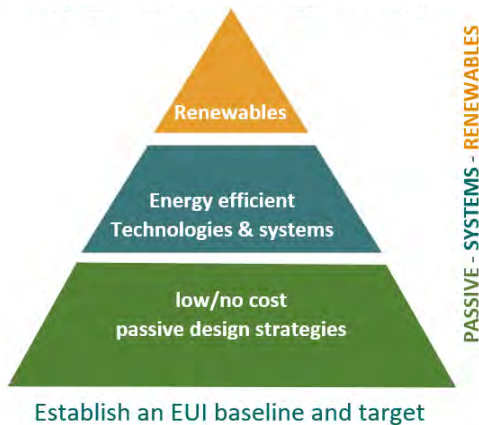

Figure 4: Energy Hierarchy as a Net-Positive-Energy Framework. Source: (Architecture 2030, 2019)

TERRAPIN'S 15 PATTERNS: Integrating Biophilic, Net-Positive & Resilient Design	
NATURE IN SPACE	Net-Positive Energy Design: Example Issues, Methods & Assessments
1. Visual connection with Nature	<p>Design Issues:</p> <ul style="list-style-type: none"> Building siting, massing, plan, and section to optimize passive strategies for daylighting, natural ventilation, heating and cooling and resiliency Site and landscape restorative design, biodiversity, habitat Ecological systems integration Building envelope: seasonal bioclimatic response <p>Design Exercises & Methods</p> <ul style="list-style-type: none"> Site, building, room, and systems seasonal programming for daylighting, passive systems, envelope response Site and living systems analyses Existing & proposed habitat and biodiversity inventories Seasonal sketches and renderings Sefaira iterative parametric building siting, form, section, and envelope studies Velux Daylight Visualizer iterative daylight studies for massing, section and select rooms Physical study models: siting, massing, section concepts Ecological and building systems integration <p>Assessment</p> <ul style="list-style-type: none"> Quantitative assessment of the integration of bioclimatic and passive strategies to reduce lighting, heating, cooling, and natural ventilation loads. Integration of health and energy performance metrics. Resiliency strategies. <i>Energy and sustainability targets:</i> Energy Use Intensity (EUI); kBtu/SF; lbsCO₂; Architecture 2030 targets; technologies and renewable energy systems integration. <i>Daylighting & electric lighting targets:</i> point-in-time and annual climate-based metrics (IESNA recommendations, Spatial Daylight Autonomy, Annual Sunlight Exposure, etc.); electric lighting integration. <i>Circadian daylight & electric targets:</i> equivalent melanopic lux, circadian stimulus; electric lighting integration; nighttime strategies to eliminate circadian disruption (blackout shades, night-time navigation). <i>Visual comfort targets:</i> glare control, views, daylight management, color rendering, electric lighting integration. <i>Thermal comfort targets:</i> ASHRAE, adapted thermal comfort, seasonal response to site, building, envelope. <i>Water & waste targets:</i> water harvesting, graywater, and potable targets and metrics (optional; student choice) <i>Biodiversity & habitat:</i> Sustainable SITE & Resilient Design Institute metrics <p><small>NOTE: Net-Positive Water, Waste, or Materials or other Resilient. Design issues optional for studio due to 7-week timeline.</small></p>
2. Non-Visual Connection with Nature	
3. Non-Rhythmic Sensory Stimuli	
4. Thermal and Air Flow Variability	
5. Presence of Water	
6. Dynamic and Diffuse Light	
7. Connection with Natural Systems	

Table 3: Nature in Space Patterns and potential overlay with net-positive and resilient design. Source: (Author, Terrapin 15 Patterns, 2021)

As a net-positive design framework, the “energy hierarchy,” locates passive design as the foundational strategy of a three-fold approach: 1) reduce energy demand and promoting energy conservation (including site design, architectural form, and bioclimatic and passive design), 2) use energy efficient and high-performance systems, and 3) integrate renewable energy systems. Biocentric approaches to site and landscape design were encouraged to integrate ecological systems, urban habitat, biodiversity, flora and fauna, seasonal and migratory species, and restorative and resilient design. Students considered how biophilic and experiential considerations might overlay regenerative and resilient design strategies for daylighting, natural ventilation, passive heating and cooling, as well as restorative strategies for the landscape and site habitat. A biophilic lens encouraged students to balance quantitative metrics and assessments of building siting, form, section, and envelope to optimize energy performance and GHG emissions while considering qualitative human-nature connections, experience of time and seasons, and enhanced biodiversity and habitat. The same design strategies employed to reduce energy and GHG emissions could also support their biophilic agendas.

Sefaira energy software, Climate Studio, Climate Consultant, and Velux Daylight Visualizer were used to evaluate quantitative performance goals, with students determining the trade-offs they were willing to make to integrate qualitative and quantitative biophilic and net-positive goals and performance metrics. Supporting resources to bridge the net-positive energy analysis with broader biophilic and ecological scales included select landscape design resources such as the RDI’s *16 Resilient Design Strategies* (RDI, 2021), the *SITES v2 Rating System* (SSI, 2015), and the *Living Building Challenge v.4* (ILFI, 2019). Table 3 (above) illustrates the potential intersection between quantitative issues and metrics and qualitative experiential site issues to foster “positive” human and ecological benefits. Example student work is found in Figure 5 below.



Figure 5: Example “Nature in Space” site and building studies. Source: (Connor McManus, Drew Tangren, Yalun Chen)

3.2. Nature Analogue Patterns and the Energy Hierarchy

Terrapin’s “Nature Analogue Patterns” consider literal, metaphoric, and symbolic connections with nature through material selection, biomorphic and organic forms, complexity and order, and related finishes and details. Students developed seasonal programming, renderings, collages, and physical models to explore material qualities and to consider the experiential and ecological impacts of structure and materials. The envelope was explored through the lens of “fivefold function,” to address the multiple roles the building envelope could play to foster seasonal connections between inside and outside, contact with flora and fauna; harvesting onsite energy; celebrating the atmosphere of place, among other related issues. The facades, roof, and exterior spaces were explored as opportunities to create habitat and biodiversity. Qualitative assessments were evaluated based on the programming goals, desired atmosphere and experiential aspirations, and seasonal response.

Biophilic intersections with net-positive and resilient design were considered through iterative exploration of building and envelope form and details, structure, materials, and systems integration to simultaneously reduce energy consumption, GHG emissions, and waste while fostering durability and the reduction of ecological impacts on natural systems, habitat, and biodiversity. The selection of materials for the building envelope, interior finishes, and details were quantitatively assessed using Sefaira to determine the impact of materials specifications and properties on luminous and thermal comfort as well as annual energy performance related to heating, natural ventilation, and cooling. Table 4 includes potential issues, design exercises, and assessment methods. Examples of student work are found in Figure 6 below.

NATURE ANALOGUE PATTERNS	Net-Positive Energy Design: Example Issues, Methods & Assessments
8. Biomorphic Forms and Patterns	<p>Design Issues</p> <ul style="list-style-type: none"> Form, materials, sections, envelope and details for daylight, natural ventilation, and passive design to enhance literal, metaphoric, or symbolic nature connections.
9. Material Connection to Nature	<ul style="list-style-type: none"> Material qualities and thermal and luminous properties (massing, color, textures, and reflectivity) to support nature connections, atmospheric goals, and optimize passive design for heating, lighting, and cooling.
10. Complexity and Order	<ul style="list-style-type: none"> Structure, construction methods, materials selection for design, health, durability, ecological impact, and resiliency.
	<p>Design Exercises & Methods</p> <ul style="list-style-type: none"> Structure, materials, and envelope seasonal programming Seasonal design of select building envelope conditions Iterative structure and materials massing studies Iterative form, section, and envelope studies Material inventories: experiential and eco-impacts Video, time-lapse photography of study models to consider atmospheric qualities of structure, materials, envelope Integration of biophilic, net-positive, and resiliency goals.
	<p>Assessment</p> <ul style="list-style-type: none"> Quantitative assessment of envelope optimization with Sefaira, Climate Studio, and Daylight Visualizer for thermal comfort, passive strategies, and systems integration. Quantitative of materials to address health and wellbeing energy, GHG, waste, durability, lifecycle, and related issues. Qualitative assessment of seasonal experience and atmosphere of structure, materials, and finishes using video, time-lapse photography, study models, and/or rendering; revisit seasonal programming.
	<p><i>NOTE: Net-Positive Water, Waste, or Materials or other Resilient Design issues optional for studio due to 7-week timeline. .</i></p>

Table 4: Nature Analogue Patterns and potential overlay with net-positive and resilient design. Source: (Author, Terrapin 15 Patterns, 2021)



Figure 6: Example “Nature Analogue” Structure, materials, and form studies. Source: (Shay Koochi, Yutong Yang, Yifan Liu)

3.4. Nature of Space Patterns and the Energy Hierarchy

Terrapin’s “Nature of Space Patterns” emphasize the human experience of time, weather, quality of space, form, materials, and details to realize the seasonal experiential and atmospheric program goals. The five patterns explore the desired character and quality of space, including prospect and refuge, mystery, risk and peril, and awe. Students developed an atmospheric program for one “important space” to refine and integrate biophilic and net-positive strategies across the three categories of “nature of space,” “nature in space” and “nature analogue” patterns. They revisited the relationships between the desired atmospheric character of space and earlier design decisions regarding siting, massing, section, envelope, room form, materials, structure and the dynamic and changing qualities in time and seasons.

Atmospheric programming and exercises focused on seasonal qualities of space, form, materials, and light using time-lapse video, digital renderings, collage, photography, and large-scale physical room modeling. Iterative quantitative analyses using Velux Daylight Visualizer, V-Ray, Lumion, and/or Sefaira enabled students to consider qualitative and atmospheric trade-offs related to earlier energy and GHG analyses. See Table 5 and Figure 7.

NATURE OF SPACE PATTERNS	Net-Positive Energy Design: Example Issues, Methods & Assessments
<p>11. Prospect</p> <p>12. Refuge</p> <p>13. Mystery</p> <p>14. Risk/Peril</p> <p>15. Awe</p>	<p>Design Issues:</p> <ul style="list-style-type: none"> • Seasonal site and building experiences; interactions with flora and fauna; atmosphere • Integration of daylight, natural ventilation, and passive strategies with desired spatial, experiential, and atmospheric qualities such as site connections, views, illuminance levels, contrast ratios, and luminous journey. • Envelope: seasonal response; occupant interaction; habitat integration. • Finishes, furnishings, systems integration. • Designing spaces that are valued and loved through time to foster health and well-being, resilience, and sustainability. <p>Design Exercises & Methods</p> <ul style="list-style-type: none"> • Atmospheric programming; Seasonal space use, ambiance, and inside-out relationships. • Iterative envelope, room, detail studies. • Time-lapse rendering, models, and detail studies, • Seasonal and diurnal video walk-throughs. <p>Assessment</p> <ul style="list-style-type: none"> • Qualitative assessment of luminous, thermal, and experiential qualities of structure, materials, form. • Quantitative considerations on related net-positive performance on a seasonal basis. Revisit Sefaira, Velux, Climate Studio analyses. <p><i>NOTE: Net-Positive Water, Waste, Materials, or other Resilient issues optional for studio due to 7-week timeline.</i></p>

Table 5: Nature of Space Patterns and potential overlay with net-positive and resilient design. Source: (Author, Terrapin 15 Patterns, 2021)

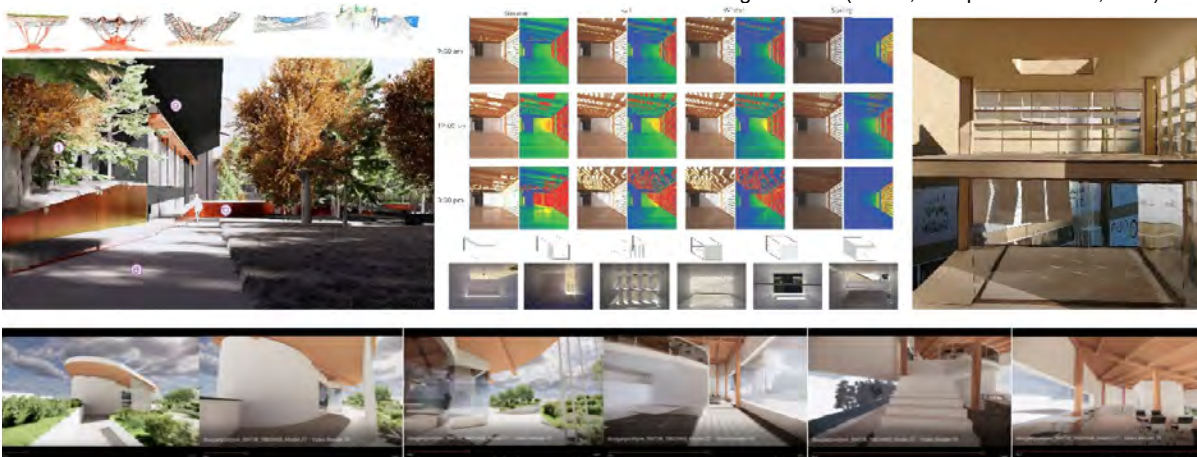

Figure 7: Example “Nature of Space” studies; site, building, and room atmosphere studies. Source: (Whitney Donohue, Jocelyn Dougan, Josh Himes, Emma Rutkowski)

CONCLUSIONS

The Biophilic Net-Positive Design Studio has been taught in the M.Arch Program at the University of Minnesota for three years. Several lessons have emerged that are useful in considering the integration of Terrapin's *15 Patterns of Biophilic Design* in a "net-positive" studio (energy, materials, waste, and/or water):

1. *Biophilic Framework Overlays for Site and Passive Design*: The *15 Patterns* easily overlay resilient and regenerative design approaches to net-positive energy design. Passive design strategies at the site, building, envelope, room, and systems scales strongly integrate with qualitative and quantitative issues related to the "Nature in Space" patterns that define essential relationships to place, time, and the dynamic forces of weather, sun, wind, light, and climate change. These strategies can be strategically integrated with biophilic benefits for comfort, health, and well-being, while fostering biodiversity and habitat protection/restoration at the site scale.
2. *Define Integrated Biophilic, Net-Positive, and Resilient Design Programming*: Explore and revisit the site, building, envelope, and room programming to determine how the biophilic design strategies can integrate and reinforce other design issues and priorities across seasons and scales.
3. *Select Several Biophilic Patterns as Design Priorities*: Consider which biophilic patterns are most impactful and provide the greatest human and ecological benefits.
4. *Explore Qualitative & Quantitative Design Dimensions of the Three Categories of Patterns*: 1) Nature in Space, 2. Nature Analogues, and 3) Nature of Space. Work back and forth across scales to integrate qualitative experiential goals with quantitative assessment and performance metrics. Consider design and ecological priorities and trade-offs. Repeatedly revisit and update the program and performance goals and critique opportunities and trade-offs for integration.
5. *Next Steps: Translate other Net-Positive Topics*: Explore how a biophilic framework might intersect with not only net-positive energy, but also waste, water, and materials, and/or other "positive benefits".
6. *Take Biophilic Breaks*: Integrate hands-on contact with nature and other species by taking breaks outside to explore the bioregion, site, weather, flora and fauna, and the personal impressions, experiences, and "positive benefits" of nature.
7. *Next Steps*: The upcoming studio will develop a pre- and post-studio survey to better determine the effectiveness of the studio assignments as well as more explicit qualitative and quantitative performance goals for project evaluations.

ACKNOWLEDGEMENTS

The author gratefully acknowledges the contributions of students, colleagues, and guests who have contributed to the Biophilic Net-Positive Design Studio. A special thank you to Pat Smith, Center for Sustainable Building Research and Chris Wingate, MSR Architects, for their contributions as energy and technical design consultants.

REFERENCES

- Browning, B. and Cooper, C. 2015. *Human Spaces*, Atlanta GA: Interface: https://greenplantsforgreenbuildings.org/wp-content/uploads/2015/08/Human-Spaces-Report-Biophilic-Global_Impact_Biophilic_Design.pdf.
- Browning, Bill and Ryan, Catie. 2020. *Nature Inside: A Biophilic Design Guide*. London: Royal Institute of British Architects.
- Climate Positive Design. Climate Positive Design Challenge, <https://climatepositivedesign.com/>.
- Crutzen, Paul and Stoermer, Eugene. May 2000. "The 'Anthropocene'." *Global Change Newsletter*, IGBP, 41, <http://www.igbp.net/download/18.316f18321323470177580001401/1376383088452/NL41.pdf>.
- Fitwel Organization. 2020. *Fitwel Certification System*. <https://www.fitwel.org/>.
- Fromm, Erich. 1973. *The Anatomy of Human Destructiveness*. New York: Holt, Rinehart and Winston.
- _____. 1964. *The Heart of Man. Its Genius for Good and Evil*. New York: Harper and Row.
- Hess, Lily. 2020. "We are Nature". *Landscape News*, <https://news.globallandscapesforum.org/48134/we-are-nature-and-nature-is-us/>.
- International Living Futures Institute. 2019. *Living Building Challenge 4.0*, <https://living-future.org/lbc/>.
- International Well Building Institute. 2020. *WELL Building Standard*. <https://www.wellcertified.com/>.
- Kellert, Stephen R. October 26, 2015. What Is and Is Not Biophilic Design? New York: Metropolis, <https://www.metropolismag.com/architecture/what-is-and-is-not-biophilic-design/>.
- Kellert, S. and E. Calabrese. 2015. *The Practice of Biophilic Design*, <https://www.biophilic-design.com/>.
- Kellert, S., Heerwagan, J., and Mador, M. 2008. *Biophilic Design*, New Jersey: John Wiley & Sons, Inc.
- Kellert, S. and Wilson, E. O. 1993. "Biophilia and the Conservation Ethic," *Biophilia Hypothesis*. Washington DC: Island Press.
- Malhi, Yadvinder. 2017. "The Concept of the Anthropocene." *Annual Review of Environment and Resources*, Vol. 42:77-104, <https://www.annualreviews.org/doi/abs/10.1146/annurev-environ-102016-060854>.
- Mang, Pamela, and Reed, Bill. 2014. "The Nature of Positive," *Building Research & Information*, Volume 43, 2014 – Issue 1: <https://www.tandfonline.com/doi/full/10.1080/09613218.2014.911565>.
- Milne, Murray. 2020. Climate Consultant 6.0. Los Angeles, CA: University of California, <http://www.energy-design-tools.aud.ucla.edu/climate-consultant/request-climate-consultant.php>.
- Resilient Design Institute. Resilient Design Principles, <https://www.resilientdesign.org/the-resilient-design-principles/>.
- Revkin, Andrew C., May 11, 2011, "Confronting the 'Anthropocene'." *New York Times*, <https://dotearth.blogs.nytimes.com/2011/05/11/confronting-the-anthropocene/>.
- Sturgeon, Amanda. 2017. *Creating Biophilic Buildings*. Seattle: International Living Futures Institute.
- Sustainable SITES Initiative. SITES Rating System, <https://www.sustainablesites.org/>.
- Terrapin Bright Green. 2014. *Terrapin's 14 Patterns of Biophilic Design*. New York: Terrapin, <https://www.terrapinbrightgreen.com/reports/14-patterns/>.
- US Green Building Council, *Leadership in Energy and Environmental Design (LEED)*, <https://new.usgbc.org/leed>.
- Wilson, Edward O. 1984. *Biophilia*, Cambridge: Harvard University Press.

The Neighborhood Accessibility Framework: A Methodological Instrument to Assess Neighborhood-Level Determinants That Affect the Health of Urban Residents

Hitakshi Sehgal¹

¹University of Minnesota, Twin Cities, MN

ABSTRACT: This paper introduces the Neighborhood Accessibility Framework as a methodological instrument to assess the neighborhood-level determinants that affect the lifestyle of residents and can lead to conditions like hypertension, cardio-vascular diseases, diabetes and obesity. Neighborhoods comprise land uses such as residential, commercial, leisure, transit, and retail for daily essentials. Residents access facilities and spaces in their vicinity and, in the process, build communities, which comprise the socio-cultural fabric of their neighborhood. Existing scholarship defines accessibility as a fundamental concept that determines the freedom with which one can participate in activities in their immediate environment. This translates into the ease with which residents can access shopping, cultural amenities, and primary healthcare, in addition to partake in activities of socializing and exercising within their neighborhood. This study is based on the premise that the aggregate of accessibility parameters in a neighborhood constitute exposures that affect the health of residents. Research on the correlation between urban environmental exposures and their effect on health outcomes reinforces neighborhood advantage, or disadvantage. In urban studies accessibility parameters have been studied independently vis-à-vis their correlation with health. Existing research does not account for interdependency between accessibility parameters and their cumulative impact on health outcomes. To methodologically assess these accessibility parameters, this study uses the Walkability Framework as a starting point to formulate the Neighborhood Accessibility Framework, as a comprehensive matrix of neighborhood-level determinants. The Walkability Framework theorizes the relationship between walkability and the built environment. The Neighborhood Accessibility Framework builds on this model to assess residents' perceptions of space, third places, density, parking, streetscape and experience, land use, connectivity, surveillance, pedestrian safety, and public transport in their neighborhood. The Neighborhood Accessibility Framework is a much-needed instrument that contributes to research methodology in inter-disciplinary research on urban-environmental design and public health.

KEYWORDS: Neighborhoods, Accessibility, Public Health, Urban Health, Methods, Environment

INTRODUCTION

Neighborhoods in urban areas are the link between the home and the city. In their neighborhood, people access the natural, built, economic and retail surroundings and transit to connect to the larger urban area for their daily needs. Access or lack of access to daily needs within the neighborhood has the potential to affect the health of residents (Sehgal and Toscano 2021). The neighborhood is a part of the exposome, which is a larger determinant of health. Every exposure outside the genes, the thousands of chemicals, drugs, built and natural components, psychosocial, cultural, socioeconomic, dietary, literary, auditory signals collectively form the exposome (Toscano et al. 2014; Wild 2012). The human phenotype, or external appearance including health and disease status is the result of interactions between the genome and the exposome (Guthman and Mansfield 2013; Toscano et al. 2014). Epigenetic research identifies the exposome comprehensively and provides evidence of the somatization or molecular and physical expression of unconventional exposures such as discrimination and stress (Guthman and Mansfield 2013; Toscano et al. 2014). The influence of place and geography on health is well known and neighborhoods embody the physical and social determinants of health, which lead to epigenetic changes that affect health and disease outcomes (Notterman and Mitchell 2015; Sehgal and Toscano 2021). Key findings from research on neighborhoods include their decisive role and effects on behaviors and socio-cultural determinants contributing to evidence beyond conventionally studied pollutants or toxicants (Notterman and Mitchell 2015; Roux 2016; Sehgal and Toscano 2021). A milestone has been the identification that neighborhoods affect multiple health outcomes via interdependent pathways (Roux 2016), which has changed the common belief and habitual inquiry on individually determined risk factors for disease. The pathways that link health determinants in neighborhoods to outcomes are rarely linear and challenge the conventional exposure-disease paradigm, which is that a physical exposure leads to a measured and known physical dysfunction in the body (Toscano et al. 2014).

Studies on urban exposomes indicate its' exclusive effect on the health of residents (Andrianou and Makris 2018).

Global environmental changes (GECs) such as climate change and associated events of droughts and floods are forcing migration and urbanization. Over 75% of the world's population is expected to live in urban areas by 2050. Demographic alterations, rapid urbanization and the concomitant overcrowding, land use changes, overburdened infrastructure, persistent effusion of toxins into the environment and urban sprawl are detrimental to health as they weaken the natural systems that the human civilization is built upon (Frumkin and Haines 2019). These phenomena expose urban residents to air and noise pollution, social stratification, chronic stress, deficient green, recreational and public spaces and strained public transport. The results are unhealthy behaviors (automobile dependence, poor eating habits and physical inactivity), dietary shifts, sedentary lifestyle, poor social capital and high risk of injuries, respiratory diseases and mental health disorders. The urban populations' vulnerabilities are exaggerated by incapacitated communities, social services and healthcare delivery systems (Frumkin and Haines 2019). Urbanization is one pathway via which GECs lead to diseases like hypertension, type 2 diabetes, cardiovascular diseases and obesity (Frumkin and Haines 2019; Sehgal and Toscano 2021). These diseases are referred to as common complex diseases given their global widespread prevalence, non-infectious nature, lack of a singular cause, their inheritability patterns, the involvement of multiple genes, and the role of the environment and lifestyle in their occurrence (Sehgal and Toscano 2021; Toscano et al. 2014). Prevention strategies for these diseases are often unsuccessful because they have a conservative focus on behavior change in individuals. Behaviors are only consequences and are secondary to the environment in which people act. The focus on individual behaviors is a counter-productive strategy if the environment provides no scope for healthy behaviors and lifestyle changes to those at risk of or suffering from common complex diseases (Frumkin and Haines 2019; Sehgal and Toscano 2021). These diseases have no cure, and all medical treatments require that the patients adopt lifestyle changes along with medications (Sehgal and Toscano 2021). Therefore, opportunities to access a healthy lifestyle are fundamental to prevent, treat and control the rising prevalence of common complex diseases. Walkability, social stratification, neighborhood poverty, green space and parks, air quality, noise, overcrowding, land use mix, risks of injuries, inadequate housing and salutogenic potential (ability to promote health and well-being) (de Jong et al. 2012) are factors in the urban exposome that have been studied and associated with common complex diseases (Frumkin and Haines 2019).

1.0 THE NEIGHBORHOOD AS AN EXPOSOME AND ACCESSIBILITY

The neighborhood is a cumulative of determinants that affect behaviors and consequently the health of residents. Determinants of health in the exposome rarely act in isolation and human health is an expression of the cumulative exposures and their interaction with the human genome (Thakur and Roy 2020). People are randomly exposed to, or they intentionally access the built, natural, socio-cultural, retail and economic components within their neighborhood. Access and accessibility within a neighborhood are both vital for the people living in a neighborhood. Existing scholarship defines accessibility as a fundamental concept that determines the freedom with which one can participate in activities in their immediate environment (Miller 1999). Accessibility within an urban neighborhood is a measure of the facilitation of access to all provisions in the environment (Alwadi, Khaleel, and Benkraouda 2021). This translates into the ease with which residents can go about their daily activities such as shop for their regular needs, socialize, find cultural and literary opportunities, find salutogenesis, access primary healthcare, exercise, and connect to the larger urban area. Accessibility to daily needs or the lack of it, influences behavior choices residents must make habitually. The behaviors people choose become their lifestyle and subsequently affect their health and susceptibility to disease (Sehgal and Toscano 2021). Thus, when we assess accessibility, we assess the choices and opportunities that people have rather than categorize their behavior as healthy or unhealthy and hold them responsible for their choices.

In the macro-urban space, the neighborhood is at the nexus where the global meets the local and therefore, urbanization and globalization affect the neighborhood. In the larger urban exposome, the neighborhood forms an exclusive exposure (Andrianou and Makris 2018; Sehgal and Toscano 2021). Neighborhoods are documented to affect safety, social capital, social cohesion, collective efficacy; behaviors of physical activity, diet, nutrition, alcohol and tobacco use, street violence and all these factors independently affect common complex diseases (Browning and Cagney 2003; Roux 2016; Sehgal and Toscano 2021; de Jong et al. 2012). There remain gaps in research that accrues neighborhood level determinants and their relationship with common complex diseases. This study is based on the premise that the aggregate of accessibility parameters in a neighborhood constitute exposures that affect the health of residents. The aim of this study is to address the gap in identifying the entire neighborhood as an exposure that affects health and susceptibility to disease among residents. The objective of this paper is to present a methodological instrument to assess the neighborhood-level determinants that affect the lifestyle of residents.

2.0 EXISTING FRAMEWORKS, MODIFICATION AND NEIGHBORHOOD LEVEL DETERMINANTS

2.1 The Walkability Framework

The Walkability Framework (WAF)(Zuniga-Teran et al. 2017) is an effective tool that theorizes the relationship between walkability and the built environment. It is a framework to measure the efficacy of the built environment to enable walking among residents of the neighborhood and thereby reinforce their health and well-being. It is based on the premise that walkability, promotes walking (for transportation or recreation) and health by providing an environment for people to be less sedentary, physically inactive and automobile dependent. Walkability focusses on active and sedentary behaviors and is a significant determinant of neighborhood accessibility. The Walkability Framework conceptualizes neighborhood design to include nine walkability categories of connectivity, density, land use, traffic

safety, surveillance, experience, parking, greenspace and community. This paper uses the WAF as a starting point to formulate the Neighborhood Accessibility Framework (NAF), a comprehensive matrix of neighborhood-level determinants that together represent the neighborhood as an exposome.

The Neighborhood Accessibility Framework builds on the walkability model to assess residents' perceptions of access to space, third places, streetscape and experience, land use, connectivity, surveillance, pedestrian safety, public transport, density and parking in their neighborhood. The framework is modified in a way to include new factors and rework the existing ones to enhance the capacity of evaluating accessibility in the neighborhood. Space and public transport are new factors in the NAF, third places are a modification of the 'community' variable in the WAF, streetscape and experience are independent factors in the WAF and have been combined in the NAF, and traffic safety is modified to pedestrian safety.

The accessibility determines if people have opportunities to a healthy lifestyle and can be correlated with people's behaviors. The freedom with which people can access their neighborhood and participate in activities is a more perceptive assessment technique than actual behavior (Miller 1999). This includes the socio-cultural environment and people's ability to be in it as well as influence it. An inaccessible or poorly resourced neighborhood restricts people's access, they are likely to adopt sedentary behaviors or use automobiles, and they could experience loneliness, stress and feelings of constrain, all of which lead to poor physical and mental health. Perception of lack of social support adversely affects health more than its actual absence (Browning and Cagney 2003). As with WAF, accessibility can be assessed through people's perception of their neighborhood and sample questions are included in table 1.

2.2 The Neighborhood Accessibility Framework

Table1 presents the determinants that together represent the neighborhood as an exposure and that have the potential to affect health and wellbeing.

Table 1. The neighborhood level determinants that can be aggregated to represent the neighborhood as an exposure.

Neighborhood Determinants	Level	Provide accessibility to	Questions to assess residents' perceptions of access: <i>The neighborhood I live in:</i>
Space		<i>Open and enclosed public spaces for an active lifestyle</i>	<ul style="list-style-type: none"> -Offers me open space for a physically active lifestyle - Offers me open space for playing sports - Has a community gymnasium that I can access - Has a community swimming pool I can access for fitness and leisure
Third places		<i>Safe access to public spaces for social, cultural and literary opportunities.</i>	<ul style="list-style-type: none"> - Has cultural activities that I can be a part of - Has a neighborhood/ community organization that I can be a part of - Has an event space I can visit for theatre, arts, and cultural immersion - Has a religious facility I can visit - Has a library that I can use - Has a school that my children can go to - Is a close-knit neighborhood where everyone knows each other and socializes - Has green pockets, such as parks
Streetscape and experience		<i>Conducive environment to be outside</i>	<ul style="list-style-type: none"> - Is aesthetically pleasing - Is green with trees providing shade on footpaths - Is generally free from litter
Land use		<i>Multipurpose utilities required on a daily or emergency basis</i>	<ul style="list-style-type: none"> - Has a fresh food market that I can use - Has a fresh meat and fish market that I can use - Has a store I can buy groceries at - Has a health-care clinic I can go to - Has a store where I can buy sundry items I often need - Has corner stores for easy access to regular grocery needs - Has a 24-hour pharmacy - Has a hospital for emergency needs
Connectivity		<i>Pedestrian paths that connect to various destinations</i>	<ul style="list-style-type: none"> - Has a good pedestrian path that I can use as I go about my daily activities
Surveillance		<i>Safe access (for people of all genders, ages, and SES)</i>	<ul style="list-style-type: none"> - Is safe for individuals of all gender to be out and about - Is safe for individuals of all ages to be out and about - Is safe for individuals of any socio-economic class to be out and about

<i>Pedestrian safety</i>	<i>Access and safety (without injuries)</i>	<ul style="list-style-type: none"> - Has crosswalks and regulated traffic and is safe for crossing streets - Has a good pedestrian path that the elderly and physically challenged can use
<i>Public transport</i>	<i>Clean environment and the larger urban area</i>	<ul style="list-style-type: none"> - Offers me public transport options for my need to connect within the city
<i>Parking Density</i>	<i>Active lifestyle Conducive environment, safety</i>	<ul style="list-style-type: none"> *Must be assessed by actual neighborhood survey * Must be assessed by modern techniques to measure footfall, or pedestrian, vehicle and residential density

The determinants in a neighborhood that affect health and wellbeing and must be accessible at all times include:

1) Space: Space, open or enclosed, for an active physical and social lifestyle is a part of public places and must be accessible to everyone without discrimination. Space is a determinant that includes all open spaces for sports and physical activities. Community or city funded gymnasiums and swimming pools are a part of space because these offer choices in terms of activity as well as indoor options when the weather does not permit being outside. Urban sprawl and overcrowding exhaust spaces and resources for maintenance of spaces, and constrain exercise behaviors, active access and socialization in the neighborhood. The resulting sedentary behaviors and mental health disorders increase susceptibility to common complex diseases (Sehgal and Toscano 2021; Frumkin and Haines 2019). Accessibility to spaces can be restricted for various reasons from lack of enough spaces, encroachment, lack of connectivity, or reasons such as privatization restricting access due to time limitations, costs or discrimination (Phadke, Khan, and Ranade 2011; Leclercq and Pojani 2021). Lack of public infrastructure is a challenge, and space is often compromised in fast-growing and underfunded urban areas.

(2) Third places: As people go about their lives and traverse in and through their neighborhood, they interact and build communities which, form the socio-cultural fabric of the neighborhood. Third places are instrumental to the socio-cultural fabric of the neighborhood. These are places within the neighborhood that people can walk to and can gather at for recreation. People spend most time at home (first place) and at work (second place) and third places provide opportunities for recreation (Oldenburg 1997). Third places also account for safety and surveillance in neighborhoods. Vanishing third places were first discussed by Ray Oldenburg in the late 90's. Key features of third places are i) proximity to the home for walkable access discouraging dependency on automobiles for travel and ii) opportunities other than technology for entertainment. Suburban neighborhood design post World War II, did not promote community interaction, lacked community space, and had transformed all that was 'local' into 'remote' (Oldenburg 1997) thus hampering accessibility. Third places are more threatened today across urban areas as not just entertainment, shopping and socialization are also increasingly digitalized. Digital dependency has increased exponentially with the increase in the reach of the internet and social media (Leclercq and Pojani 2021). Automobile and digital dependency are unhealthy behaviors that exacerbate a sedentary lifestyle and lack of interaction, which can lead to common complex diseases (Koyanagi, Stubbs, and Vancampfort 2018; Frumkin and Haines 2019). Accessibility to third places contributes to physical, social and psychological wellbeing, all of which contribute to prevention of common complex diseases. Sustained social networks require sound neighborhood structure (Browning and Cagney 2003). Third places promote community building capacity and likely have the same effect as public spaces in breaking the class-based socio-cultural dismemberment (Németh and Schmidt 2011). Research on public places, touches upon the potential of third places even though it does not use the same terminology. More research is required to include accessibility to third places without discrimination. Coffee shops and privatized public spaces may receive a heavy footfall (Leclercq and Pojani 2021), however, are these really third places and can people of all class, gender, caste, race, color, and ethnicity access these places globally? What is the difference when these places are contrasted with free to access beaches, lake sides, riverfronts, marinas, street markets, or market avenues that can be accessed at minimal or no cost? (Németh and Schmidt 2011) Discussion on women's right to loiter, access recreational spaces and have fun in Mumbai revealed that discrimination based on gender, religion and class reshape accessibility to these basic rights (Phadke, Khan, and Ranade 2011). These discussions must be mainstreamed so that debates on accessibility to third places do not remain restricted to their existence and privatization. Oldenburg's ideas must be explored, debated and critiqued to understand socio-cultural spatiality in neighborhoods. The Neighborhood Accessibility Framework offers potential to explore people's perception of access to third places.

(3) Streetscape and Experience: These are conducive factors that make an impression and include the weather, atmosphere and cues that affect the senses. Civic planning, aesthetics and infrastructure to function in the local weather are attributes that affect if and how people access their neighborhood. With climate change, urbanization, urban sprawl and overcrowding, urban planning authorities can be pressed for funding to keep up the city space and neighborhoods. The absence of streetscape and experience can discourage active behavior in people and have a direct repercussion on obesity and cardiac health (Frumkin and Haines 2019).

(4) Land Use: This should be mixed rather than exclusively residential. The residential neighborhood should be supported with access to retail, essential and healthcare facilities. Retail is an essential aspect of daily life and includes grocery and departmental stores, fresh vegetable, meat and fish markets, corner stores for frequently bought items such as milk and bread, and healthcare facilities should include emergency care, primary healthcare units and 24-hour

pharmacies. Apart from walking to these destinations, accessibility to these facilities with mixed land use allows residents to buy a variety of foods and access healthcare as per their requirement and easily. When these facilities are not located within the neighborhood, residents are burdened with purchasing things, lugging them and storing them. Non-availability of primary healthcare in the neighborhood can lead to a lackadaisical attitude in accessing basic services such as monitoring and maintenance of blood pressure and blood sugar and can have a detrimental effect on those vulnerable to common complex diseases. In populations with high prevalence of common complex diseases, the prevalence of cardiovascular diseases and emergencies such as heart attacks and strokes are more likely to occur. Lack of emergency healthcare services leads to greater morbidity and mortality and increases the burden of diseases.

(5) Connectivity: This accessibility factor assesses how well the neighborhood connects from within with pedestrian paths and street networks that maximize options and simplify walkability. Better connectivity provides motivation and safety for active behaviors and for being outside, and bolsters access to spaces, third places and utilities thus enhancing the aggregated exposure of the neighborhood.

(6) Surveillance: The traditional and effective method to evaluate surveillance is to assess for 'eyes on the street' (Jacobs 2016). Privatization of public spaces, gender, race, ethnicity, class and color prejudices however can curb accessibility. Accessibility could be restricted in a walkable neighborhood due to socio-cultural acceptance of discrimination and surveillance could be a factor that supports this. Surveillance is reflected in the diversity a place allows and by asking people about their ability to access their neighborhood. If residents of a neighborhood perceive safety from age, gender and class related crimes and can live and move around with freedom, then 'eyes on the street' are effective. Otherwise, this surveillance can be discriminatory to accessibility as is often perceived by communities such as the poor, females, other genders and people of color and ethnicity different from those dominant in the neighborhood (Phadke, Khan, and Ranade 2011). To put security above inclusion or publicness continues to be a threat to freedom and accessibility both of which affect health behaviors and are fundamental to physical, social and mental health. The newer systems of surveillance must be evaluated from people's perceptions because camera surveillance is only a secondary method of surveillance, and it rather helps in investigation of crime than to prevent crime and create comfortable spaces (Leclercq and Pojani 2021).

(7) Pedestrian Safety: Injuries are a leading cause of morbidity and mortality and increase the global burden of disease in urban areas (Naghavi et al. 2016; Frumkin and Haines 2019). Poor pedestrian safety can instill a fear of accessing the neighborhood among residents and adversely affect the prevention and treatment those vulnerable to common complex diseases. Urban sprawl, encroachment, traffic violations and poor maintenance of pedestrian paths, all restrict accessibility in a neighborhood (Sehgal and Toscano 2021). Lack of accessibility to pedestrian space and increasing automobile dependence may indicate that pedestrians are lesser citizens (Phadke, Khan, and Ranade 2011) and exacerbate sedentary and automobile dependent behaviors in populations.

(8) Public Transport: Transit is fundamental for urban residents to access the larger city area especially for livelihood, economic and trade purposes. Currently there are few cities across the globe which have a public transport network to support the urban population (Frumkin and Haines 2019). Studies indicate that once people own vehicles, they rarely use them discreetly and are usually automobile dependent even for walkable distances (Zhang 2006). Availability and quality of public transport are both essential for effective transit opportunities and city infrastructure (Network 2018; Handy and Niemeier 1997). Every neighborhood cannot provide facilities of higher education and jobs for most residents. Public transport directly relates to active commuting and is a sustainable way for urban populations to transit with minimal carbon emissions. Public transport probably provides the most effective choice for active commuting in a city as people tend to walk in short bouts which are evidently protective for cardiovascular health (Hamer and Chida 2008). The low carbon emissions contribute to better air quality and subsequently to better health. Transit stops within neighborhoods allow residents to commute actively and connect with the larger urban area without any stresses of driving or parking. Lack of transit or accessibility to it, forces people to be dependent on automobiles, which affect the users and the neighborhood because automobile dependency is strongly correlated with sedentary behaviors, increased vehicular density and greater air pollution, all of which adversely affect health and common complex diseases (Sehgal and Toscano 2021; Frumkin and Haines 2019).

(9) Parking: Vehicular parking within neighborhoods interferes with accessibility by disrupting design and walkability in a neighborhood and is inconducive to both (Newman and Kenworthy 1989; Zuniga-Teran et al. 2017). Parking can be assessed by ways other than participants perception because it is likely that in large cities with limited access to public transport, people would perceive it an essential requirement rather than an impediment to accessibility. Genuine challenges in access to public transport exist in many cities globally (Network 2018), and people depend on private vehicles to access the city (Sehgal and Toscano 2021).

(10) Density: is considered a positive factor to invite pedestrians and promote accessibility in neighborhoods and urban areas (Zuniga-Teran et al. 2017; Network 2018). This factor must be weighed against overcrowding that can be a disincentive to accessibility in a neighborhood. With the exception of two cities, the most livable cities in the world are medium sized and some are small with a relatively low population density (Network 2018). More people may walk in

megacities in LMICs even though the design and infrastructure are not conducive for them to walk. Thus, density and overcrowding must be differentiated and studied to analyze how they affect behaviors in the population. It is suggested that the factors of density and parking must be done outside of the questionnaire. Footfall in public transit and public space (private or publicly owned), at intersections and residential density should be used as cues to measure and compare density and overcrowding. These assessments can be done via GIS mapping to reduce the number of questions and continue to keep the participants engaged without fatigue.

For assessing the neighborhood, questions are often cultural and can be included or excluded based on where the study is conducted. For example, in LMICs a laundry service maybe a privilege or not culturally adopted. Essential services such as banking are often accessed online, and the presence of a bank may not hold much relevance. Questions regarding post office, social services, municipality offices, salons and any other amenities should be considered based on the population being surveyed.

Neighborhood boundary or walking distance is a critical determinant of accessibility and studies use distance cut-offs ranging from 800 meters to 1000 meters or a ten-minute walk as parameters (Zuniga-Teran et al. 2017; Sehgal and Toscano 2021). Researchers must decide a radius of walking distance that would determine the periphery of the neighborhood for participants. For example, for children and a higher age group, walking a longer distance may not be the only criteria that defines their health. Sound design and aggregate accessibility in the neighborhood is likely to invite people of diverse ages, capacities and identities.

3.0 NEIGHBORHOOD ACCESSIBILITY SCORE

3.1 Participant perceptions and quantification

Accessibility to the neighborhood level determinants should be quantified and averaged to create a score of the neighborhood as an exposome. In urban studies accessibility parameters have been studied independently vis-à-vis their correlation with health. The average score accounts for the interdependency of the determinants.

The participants perceptions be recorded as affirmative (yes), negative (no) or unaware (don't know). The affirmative responses to each question must be summed for all respondents in a neighborhood. The percentage of affirmative responses should be scored on a scale of 0-5 and their frequency should be determined. If less than 50% of responses are in the affirmative, then the accessibility score is 0, 51–60% of affirmative responses should be scored as 1, 61–70% should be scored as 2, 71–80% should be scored as 3, 81–90% should be scored 4 and more than 90% should receive a score of 5. This is the *affirmative response score* for each question. (For example: Access to open space: *The neighborhood I live in, offers me open space for a physically active lifestyle*; 140 respondents' answer: Yes; Total respondents in the neighborhood 200; % of affirmative responses: 70; therefore, *affirmative response score* is 3). Questions in each category of the NAF should be grouped with their scores and the scores for the category should be summed (For example: Determinant: Pedestrian Safety: *The neighborhood I live in: Has crosswalks and regulated traffic and is safe for crossing streets, - Has a good pedestrian path that the elderly and physically challenged can use*, affirmative response scores are 4 and 0 respectively, and total score is: 4+0= 4). The summed scores should be averaged and scaled from zero to ten as shown in table 2.

Table 2. The Neighborhood Accessibility Framework: Factors evaluating accessibility in a neighborhood. Accessibility scores calculated from affirmative scores and scaled from zero to ten (scores are fake and written for example).

NEIGHBORHOOD ACCESSIBILITY FRAMEWORK				
Accessibility Category	Accessibility Score			
	Neigh 1	Neigh 2	Neigh 3	Neigh 4
1. Space	6	5	3	9
2. Third Places	7	3	2	8
3. Streetscape and Experience	9	3	4	10
4. Land Use	7	9	9	9
5. Connectivity	5	3	3	8
6. Surveillance	10	10	10	8
7. Pedestrian Safety	2	0	0	5
8. Public Transport	8	8	8	10
Neighborhood Score	54	41	39	67

The total score, a sum of all neighborhood level determinants represents accessibility in the neighborhood. It is recommended that each NAF determinant should be compared and discussed in a research paper. This will lead to a debate and discussion on how neighborhoods compare based on the perceptions of their respective residents.

3.2 Mitigate bias

Researchers must use geographical information systems (GIS) mapping to get an overview of the neighborhood and match it with the accessibility scores. Perceptions of the residents should be compared with accessibility measured with geographical tools or actual surveillance of the neighborhood. The framework can be used to compare residents' perception of their neighborhood with walk scores calculated from the website using the Walk Score®.

(<https://www.walkscore.com/cities-and-neighborhoods/>, accessed on Nov 10, 2021). This combination is an excellent tool for planners because the walk score uses a geographical system to assess walking routes, analyzes population density, road metrics such as block length and intersection density to assess pedestrian friendliness. The walk score is used in public health and urban planning studies. If participants' perceptions do not match with the walk scores, results must be used as an indication that the design and planning need to be evaluated to know the reasons for the discrepancy.

3.3 Ethics

The studies must seek Institutional Review Board approvals and care must be taken to protect data if personal information such as addresses have been collected.

4.0 SUMMARY AND APPLICATION

The Neighborhood Accessibility Framework is applicable to urban and suburban neighborhoods. It is a simple tool that can be used by qualified or trained researchers in the field of public health and urban design. As populations migrate to urban areas, suburbanization is integral with urbanization and accessibility is important for sustainable development. This framework can be used independently to assess the perceptions of residents regarding accessibility within their neighborhoods or it can be a part of a larger questionnaire which also assesses a risk factor or a common complex disease such as diabetes, high blood pressure or obesity (Sehgal and Toscano 2021). This framework will allow the researcher to assemble data about the many and diverse exposures that comprise a neighborhood. Studies on common complex diseases can use this tool to examine the role of the neighborhood in the increased prevalence and susceptibility to these diseases. A greater number of research studies on access, neighborhood design and planning are done in high income countries and small or mid-size cities (Sehgal and Toscano 2021). This study addresses factors of urban sprawl and rapid urbanization to inspire research in LMICs, megacities and emerging metropolises. The most significant contribution of this study is the discussion and inquiry into the role of the environment rather than common complex diseases. Research using the NAF would provide evidence to transform the health and disease debate from the individuals' behaviors to the environment where exposures happen, and behaviors are developed.

CONCLUSIONS

As GECs propel migration across the globe, urban LMIC populations are at increased risk of common complex diseases (Sehgal and Toscano 2021; Naghavi et al. 2016). Decreased infrastructural resilience to weather patterns in poor economies and greater vulnerability to environmental effects in all urban areas requires urgent attention. The neighborhood offers potential for viable and sustainable urban design and development. The Neighborhood Accessibility Framework provides a comprehensive assessment of the neighborhood-level determinants, which can be useful in the design of health-promoting urban communities. The idea of accessibility provides city planners, policy makers and public health practitioners a window to intervene at a primary level and facilitate healthy behaviors through design and integration. Accessibility gives people the freedom from weighing every choice they make and the burden of being knowledgeable about the health repercussion of every choice they make. Urban exposomes offer maximum scope for sustainable development and living. Accessibility in urban areas will break the chain of events of hazardous environmental changes leading to poor health. The neighborhood provides an opportunity for a bottom-up approach to improving design, infrastructure and accessibility in an urban area and build resilient cities.

ACKNOWLEDGEMENTS

I thank Prof. William Toscano for his guidance and support toward my research and writing. Thank you to the anonymous reviewers of this paper; I sincerely appreciate their feedback and their time.

REFERENCES

- Alwadi, Khaled, Sahar Khaleel, and Ouafa Benkraouda. 2021. "Design and planning for accessibility: lessons from Abu Dhabi and Dubai's neighborhoods." *Journal of Housing and the Built Environment* 36: 487–520. <https://doi.org/https://doi.org/10.1007/s10901-020-09763-3>.
- Andrianou, Xanthi D., and Konstantinos C. Makris. 2018. "The framework of urban exposome: application of the exposome concept in urban health studies." *Science of the Total Environment* 636: 963-967. <https://doi.org/https://doi.org/10.1016/j.scitotenv.2018.04.329>.
- Browning, Christopher R, and Kathleen A Cagney. 2003. "Moving beyond Poverty: Neighborhood Structure, Social Processes, and Health." *Journal of Health and Social Behavior* 44 (4): 552-571.
- de Jong, Kim, Maria Albin, Erik Skärbäck, Patrik Grahn, and Jonas Björk. 2012. "Perceived green qualities were associated with neighborhood satisfaction, physical activity, and general health: Results from a cross-sectional study in suburban and rural Scania, southern Sweden." *Health and Place* 18 (no. 6): 1374–1380. <https://doi.org/https://doi.org/10.1016/j.healthplace.2012.07.001>.
- Frumkin, Howard, and Andy Haines. 2019. "Global Environmental Change and Noncommunicable Disease Risks." *Annual Review of Public Health* 40. <https://doi.org/https://doi.org/10.1146/annurev-publhealth-040218-043706>.

- Guthman, Julie, and Becky Mansfield. 2013. "The implications of environmental epigenetics : A new direction for geographic inquiry on health, space, and nature-society relations." *Progress in Human Geography* 37 (4). <https://doi.org/https://doi.org/10.1177/0309132512463258>.
- Hamer, Mark, and Yoichi Chida. 2008. "Active commuting and cardiovascular risk: A meta-analytic review." *Preventive Medicine* 46: 9 - 13. <https://doi.org/10.1016/j.ypmed.2007.03.006>.
- Handy, Susan L, and Debbie A Niemeier. 1997. "Measuring accessibility: an exploration of issues and alternatives." *Environment and Planning A: Economy and Space* 29 (7): 1175–1194. <https://doi.org/https://doi.org/10.1068/a291175>.
- Jacobs, Jane. 2016. *The Death and Life of Great American Cities*. New York, NY, USA: Vintage.
- Koyanagi, Ai , Brendon Stubbs, and Davy Vancampfort. 2018. "Correlates of sedentary behavior in the general population: A cross-sectional study using nationally representative data from six low- and middle-income countries." *PLOS ONE* 13 (8). <https://doi.org/https://doi.org/10.1371/journal.pone.0202222>.
- Leclercq, Els, and Dorina Pojani. 2021. "Public space privatisation: are users concerned?" *Journal of Urbanism: International Research on Placemaking and Urban Sustainability* 1–18. <https://doi.org/https://doi.org/10.1080/17549175.2021.1933572>.
- Miller, Harvey, J. 1999. "Measuring space-time accessibility benefits within transportation networks: Basic theory and computational procedures." *Geographical analysis* 31 (1): 187–212. <https://doi.org/https://doi.org/10.1111/gean.1999.31.1.187>.
- Naghavi, Mohsen, Amanuel Alemu Abajobir, Cristiana Abbafati, Kaja M. Abbas, Foad Abd-Allah, Semaw Ferede Abera, and Victor Aboyans et al. 2016. "Global, regional, and national age-sex specific mortality for 264 causes of death, 1980–2016: a systematic analysis for the Global Burden of Disease Study 2016." *The Lancet* 390: 1151-1210. [https://doi.org/https://doi.org/10.1016/S0140-6736\(17\)32152-9](https://doi.org/https://doi.org/10.1016/S0140-6736(17)32152-9).
- Németh, Jeremy, and Stephen Schmidt. 2011. "The privatization of public space: modeling and measuring publicness." *Environment and Planning B: Planning and Design* 38 (1): 5-23. <https://doi.org/10.1068/b36057>.
- Network, The Economist Corporate. 2018. "The Global Liveability Index 2018 A Free Overview." *The Economist*.
- Newman, Peter G, and Jeffrey R Kenworthy. 1989. *Cities and Automobile Dependence: An International Sourcebook*. Aldershot, UK: Gower.
- Notterman, Daniel A., and Colter Mitchell. 2015. "Epigenetics and understanding the impact of social determinants of health." *Pediatric Clinics* 62 (5): 1227-1240. <https://doi.org/https://doi.org/10.1016/j.pcl.2015.05.012>.
- Oldenburg, Ray. 1997. "Our vanishing third places." *Planning Commissioners Journal* 25, no. 4: 6-10.
- Phadke, Shilpa, Sameera Khan, and Shilpa Ranade. 2011. *Why loiter?: Women and risk on Mumbai streets*. India: Penguin Books
- Roux, Ana V. Diez. 2016. "Neighborhoods and Health: What Do We Know? What Should We Do?" *American Journal of Public Health* 106 (6): 430-431. <https://doi.org/10.2105/AJPH.2016.303064>.
- Sehgal, Hitakshi, and William A. Toscano. 2021. "Neighborhood exposures and blood pressure outcomes: a cross-sectional environmental study among 19–53 years-old Parsis in Mumbai." *International Journal of Environmental Research and Public Health* 18 (16). <https://doi.org/https://doi.org/10.3390/ijerph18168594>.
- Thakur, Indu Shekhar, and Deodutta Roy. 2020. "Environmental DNA and RNA as records of human exposome, including biotic/abiotic exposures and its implications in the assessment of the role of environment in chronic diseases." *International Journal of Molecular Sciences* 21 (14). <https://doi.org/https://doi.org/10.3390/ijms21144879>.
- Toscano, William A., Hitakshi Sehgal, Emily Yang, Lindsay Spaude, and Aaron F. Bettmann. 2014. "Environment-Gene interaction in common complex disease: New Approaches." *AIMS Molecular Science* 1 (4): 126-140. <https://doi.org/10.3934/molsci.2014.4.126>.
- Wild, Christopher, Paul. 2012. "The exposome: from concept to utility." *International Journal of Epidemiology* 41: 24-32. <https://doi.org/doi:10.1093/ije/dyr236>.
- Zhang, Ming. 2006. "Travel Choice with No Alternative: Can Land Use Reduce Automobile Dependence?" *Journal of Planning Education and Research* 25 (3): 311 - 326. <https://doi.org/https://doi.org/10.1177/0739456X05280544>.
- Zuniga-Teran, Adriana A., Barron J. Orr, Randy H. Gimblett, Nader V. Chalfoun, Stuart E. Marsh, David P. Guertin, and Scott B. Going. 2017. "Designing healthy communities: Testing the walkability model." *Frontiers of Architectural Research* 6: 63 - 73. <https://doi.org/10.1016/j.foar.2016.11.005>.

Domestic Spaces in the COVID-2019 Pandemic Times: Perspective of Six Female Architecture Students from the Midwest USA

Mania Tahsina Taher¹

¹University of Wisconsin-Milwaukee, Milwaukee, WI

ABSTRACT: The COVID-19 crisis significantly shifted our regular behavior patterns and reflected on our relationships with people and other built environment elements. This paper investigates these spatial experiences inside our domestic spaces from the perspective of six female architecture students. These participants made spatial mappings of their everyday activities from mid-march till the end of 2020 by creating drawings, diagrams, collages, and also added other visuals and narratives. These illustrations and narratives explain how the participants' spatial activities transformed throughout these quarantined times inside their domestic spaces and the seasonal changes from Spring to Winter. These future female architects came from diverse backgrounds, and all of them are currently attending the School of Architecture and Urban Planning (SARUP) at the University of Wisconsin-Milwaukee (UWM). I met them all in a theoretical course as an instructor that discusses behavioral, social, and cultural factors implicating the design and planning of the built environment. I prioritized to select student projects from a divergent range of race, ethnicity, age, and nationality to provide a compilation of diversified female experiences. They worked on these spatial documentations as part of a class assignment where they described their observations, behavior patterns, and actions during these pandemic quarantine times. Despite the difference in their life circumstances and spatial conditions, their emotions often intersect at several common points through pandemic anxieties, displacement, social isolation, maintaining physical distances, and lack of personal boundaries. A common point of their narratives describes their agency to feel better by coming in close contact with nature by going out for a walk regularly or adding house plants and pet animals as part of their everyday living. Their spatial documentation also mentioned the physical presence of at least one family member, relationship partner, or close friend in their spatial territories to whom they could easily connect and find solace from pandemic anxieties. All participants also described feeling better and adjusting to the norms of physical distances and social isolation along with the pandemic, from the Spring to the Fall months. The participants analyzed and explained their regular spatial activities and emotions and their spatial strategies to release their pandemic anxieties to meet the larger research question of this research, which is how the COVID-2019 pandemic influences our everyday socio-spatial activities and our perceptions towards the surrounding built environment from the female perspective.

KEYWORDS: Domestic space, COVID-2019, Female, Behavior, Midwest USA

1.0 INTRODUCTION

Since the COVID-19 crisis hit the United States and the rest of the world, we all are experiencing some degrees of social turmoil. This pandemic has impacted and significantly shifted our regular behavior patterns. These changes of behavior patterns also reflect on our relationships with surrounding people and built environment. Our spatial constriction during this pandemic leaves us all at a crossroad in our everyday responsibilities towards study, work, families, loved ones, and most importantly, to ourselves. A large group of people, particularly the young students, faced displacement from their living spaces since mid-March 2020 once the majority of institutional and workplace activities had to switch to an online teaching/learning mode. As a consequence of all these happenings during the COVID-19 pandemic, many are experiencing our everyday spatial practices differently, particularly inside our domestic spaces. This paper explores these renewed relationships with our surrounding spaces during this COVID-19 pandemic through female perspective at an urban university campus in the Midwest USA. Specifically, this paper examines how the chosen participants dealt with their growing responsibilities and changing situations and how those are reflected in their spatial behavior patterns through the Spring, Summer and Fall seasons of 2020.

These future female architects came from diverse backgrounds and are currently attending the School of Architecture and Urban Planning (SARUP) of the University of Wisconsin-Milwaukee (UWM), at different levels in their academic careers. I met them all in a theoretical course that discusses behavioral, social, and cultural factors implicating the design and planning of the built environment. As part of the course assignment, they created spatial mapping and narratives of their everyday activities from mid-March until the end of 2020. Each of their narratives expressed examples of the isolation and trauma that they had suffered through while juggling between their study, work, personal relationships, and health safety. Their narratives also describe the agencies they adopted to feel better and act stronger

during this pandemic, such as bringing nature in their everyday living as a mode for healing. Besides these narratives, the participants created plan drawings, diagrams, collages, and other visuals that explain how their spatial activities were transformed throughout these quarantined times and the seasonal changes from the Spring to Winter months.

2.0 REVIEW OF LITERATURE

This paper studies and compiles an interdisciplinary conversation to discuss and organize the research findings from a behavioral architecture perspective. Personal territory is the formation of an area to achieve optimal privacy sought by developing physical settings (Altman, 1975). Behavioral patterns influence types and levels of privacy in each individual's cultural context, personality, and aspirations (Edney, 1976). Walls, screens, symbolic boundaries, tangible boundaries, and distance are mechanisms to display privacy (Zubaidi, 2019). Based on the aspects of communities and their adopted cultures, Altman (1975) organizes the concept of territories into three categories: primary, secondary, and public territory. Lang (1987) points out that territoriality has four main characters: ownership or rights of a place; personalization or marking of a particular area; the right to defend oneself from outside interference; and being able to regulate several functions ranging from meeting basic psychological needs to cognitive satisfaction and aesthetic needs. On the other hand, cultural anthropologist Edward Hall (1963) coins the term "Proxemics" as the interrelated observations and theories of human use of space as a specialized elaboration of culture, and the effects that population density has on behavior, communication, and social interaction. Hall described the interpersonal distances of humans in four distinct zones: a. intimate space (6 to 18 inches); b. personal space (1.5 to 4 feet); c. social space (4 to 12 feet); and, d. public space (12 to 25 feet and more).

In discussing everyday spaces and human behavior, the theoretical approach that resonates is "systems of activities and systems of settings" (Rapoport, 1990). Built environment researcher Amos Rapoport uses these terms to analyze human activities and the cultural use of space. It also provides a conceptual lens to examine how human activities are carried out and formed into a system of activities. He notes that one cannot discuss single activities but only systems of activities that occur through time and space and that occur in systems of settings. Rapoport describes four significant aspects of activities under these systems of settings; they are— 01. the nature of the activities; 02. how activities are carried out; 03. how they are associated into systems; and 04. their meanings. He proposes the term "home-range" to describe a network of locations where users regularly travel and form particular behaviors attached to those spaces, such as grocery stores, bus stoppage, and a neighborhood playground.

While Rapoport discusses how human behaviors form a pattern to be contained within the built environment, sociologist Ray Oldenburg proposes an alternative approach to human participation in spaces for psychological comfort. He introduces the concept of "third places" that "host the regular, voluntary, informal, and happily anticipated gatherings of individuals beyond the realms of home and work" (Oldenburg, 2002: 13). In his study of places, Oldenburg recognizes first places like home and second places as the workplace. He emphasizes the importance of third places in the process of social participation as he mentions the spatial qualities of third places as remarkably similar to a good home in psychological comfort and the support that it provides. In his perspective, libraries, community centers, religious institutions such as churches, synagogues, mosques, and temples perform as third places. Oldenburg describes these third places as hosting grounds of physical activities and social participation that exist on neutral ground and serve as a condition of social equality. During these pandemic times, these third places were unreachable due to maintaining physical safety and distance. Many of these social activities took place through online platforms but missed the physical appeal of these collaborations and social participation.

Built environment scholar Kim Dovey provided an apt definition of home when he stated that "home is best conceived of as a kind of relationship between people and their environment" (Dovey, 1985: 33). He discusses the phenomenon of a home under three themes of approaches— order, identity, and connectedness. To Dovey that home is a demarcated territory with physical and symbolic boundaries that ensure that dwellers can control access and behavior. Home is also a kind of ordered center within which we are oriented spatially and temporally and where we distinguish ourselves from the more extensive and stranger surroundings. Finally, he describes the home as a place of autonomy, which is also fundamentally linked to home as identity which suggests some specific dynamic adaptability. Dovey indicates that the concept of order and identity for home is strongly interrelated, reflecting when our identity inside our homes is continually evoked through connections with the home orders in the past and extends that connectedness into the future. Dovey points out that home as a schema of relationships in a space that brings order, integrity, and meaning to experience in places. In these pandemic times, much of these meanings of home spaces are diminished and altered as the home had to convert as workspaces. Privacy and territorial connections to spaces also had to be shifted and re-defined as family members started to live together in the same space for much longer.

Feminist philosopher Luce Irigaray's writings point out a different notion of the significance of domestic space for women in general. She explores how domestic spaces have been historically conceived to contain and support women or make them feel inferior and lower in the social hierarchy (Irigaray, 1985). For her, gender is an essentialist distinction that favors the male-women and one primarily understood in a binary relationship with men (Beebeejaun, 2017). Thus, Irigaray points out that women are always considered to be in a subordinate position. She claims that women contain themselves within a dwelling that was not built, prioritizes their needs and which can amount to homelessness within the very home itself. Eventually, homes have become the everyday spaces of repeatable chores that have no social

value or recognition. Home is often a space for women to perform the affirmation and replenishment of others at the expense and erasure of the self; it can also be the space of domestic violence and abuse, that is, the space that harms as much as it isolates women (Grosz, 1991). For women to occupy space differently, it is straightforward for Irigaray in that significant transformations need to occur regarding women's organization of personal life. Also, there are the typical ideologies about their relationship with their living environment and nature that come into play. She emphasizes that changes need to happen in theory and cultural production regarding women and their respective spaces. Irigaray's perspectives also resonate with built environment scholar Daphne Spain's claim that our everyday built environment is organized in a gendered way to separate women from knowledge used by men to produce and reproduce power and privilege (Spain, 1992). She claims that gender will become a less critical component of the American stratification system when workplaces become sexually integrated as homes and educational institutions. In the pandemic reality, most U.S. homes with young children had to navigate without schools and childcare during these times. The heaviest burden of these added family responsibilities during the pandemic fell on mothers, especially the single ones, who faced a near-impossible choice between caring for their children and staying afloat financially (Alstott, 2020).

3.0 METHOD

This chapter's larger objective is to discuss how the COVID-19 pandemic influences women's everyday socio-spatial activities and perceptions of the surrounding built environment. Throughout this mapping exercise, students were encouraged to describe the changes in their spatial mapping through their reterritorialization of paths, edges, patterns, territory, boundaries, and actions. Also, they added details on their sense of privacy, territorial control, personal space, proxemics, body movement, and behavioral patterns. The central questions that they answered in this mapping activity are the following ones:

- What are the paths that the user traveled inside/ outside the place of residence?
- What are the significant borders and boundaries that the user distinguished while experiencing everyday activity spaces?
- How did the user establish the territories and privacies inside and outside of residence and its peripheral areas?
- How did the user identify her spatial identity during the COVID-19?
- How were the user's body movement patterns transformed during everyday activities?
- How were the user's perception of other space co-users and their activities transformed during these three seasons?

The first step was to select student projects from a divergent range of race, ethnicity, age, and country of origin in order to provide examples of diversified female experiences. Out of the thirty-five females in the classroom, six participants were chosen based on the previous criteria. All of their mappings and narratives showed their ability to demonstrate their various spatial experiences during this COVID-19 pandemic. Each participant was regularly contacted and asked for permission to publish their works through separate e-mails by the author. These e-mails contained a brief description of the assignment, its objectives, and a draft of each of their project descriptions. Each of their mapping experiences and narratives described their personal experiences and emotions. In this way, each student was extra cautious to retain some transparency throughout this writing process from an ethical stance. The participants are identified in this writing only by their surnames.

4.0 SPATIAL NARRATIVES AND MAPPINGS OF THE SIX FEMALE ARCHITECTURE STUDENTS

4.1 A Student of Hispanic Lineage in Her Early 20s

Lopez, an undergraduate architecture student at the Junior level, describes her feelings of being in a stalemate condition during an early pandemic life in Spring 2020 in a poetic way, "It was only supposed to be two weeks... Two weeks after the first warning, I noticed that my cell began to lose its color. Grey spots began appearing throughout the room, leading me into a state of confusion. What was happening?" The melancholy moments described here are a recurrent emotional experience heard throughout pandemic narratives by students of different gender, ages, race, and ethnicity in my classroom. Amid these uncertainties and confusions, the responsibilities for a living while being a full-time student did not pause for Lopez. Besides studying, she works as a Food Service Assistant at "X" Hospital's Food Service Department. Her primary job responsibility is to look over the kitchen's cleanliness and satisfactory performance while arranging and serving food to patients. During Summer 2020, when COVID was in the whole surge in Milwaukee, the hospital wards became crowded with COVID-infected patients. During that time, her access to directly serving foods to patients was restricted due to her health safety. She described her summer's full-time working environment in the hospital as "more solemn than usual" with precaution signs and distance markers around. Every time before she was walking through the hospital corridors to deliver food to patient wards, her body temperature was being checked while wearing new face masks; goggles became mandatory by the hospital authority. Outside this working environment that constantly reminded her of the current pandemic, Lopez reminisced her recuperating moments to play with puzzles or listen to the chirping of birds inside her domestic zone.

4.2 A Student of Caucasian Lineage in Her Early 20s

Klopp, an undergraduate architecture student at the junior level, described her displacement experiences throughout the pandemic in 2020 and how it reflected in her mental health. Her first displacement occurred in the mid-Spring when the school shifted from in-person to online instruction due to the widespread of COVID-2019 virus. She left her apartment in Milwaukee to live with her parents and her sister in a smaller town in Wisconsin. During this time, Klopp tried to keep her privacy in control by establishing public-private boundaries within the shared domestic space [FIG. 1], which often seemed hard to maintain. To cope with these new stresses and anxiety, she chose to adopt meditation and yoga and be physically active in the natural outdoor spaces. During the Summer of 2020, the peace that she established in her parent's home became diminished once

she started her internship at an architectural firm. Domestic space became Klopp's place to "only eat and sleep during the weekdays." During her Summer weekends, a drive to meet her partner in Milwaukee soon became her "sought-after freedom," and, by the Fall of 2020, Klopp felt excited to move back to Milwaukee and start school again. Although her new domestic space was much smaller than her parent's home [FIG. 2], she enjoyed the extension of her boundary and freedom to organize the space in her way. Amid these spatial displacements of her domestic spaces throughout the three seasons, Klopp's constant dedication to outdoor physical activities and yoga exercise helped ease the "new normal" condition during the pandemic and become accustomed to her new surroundings.

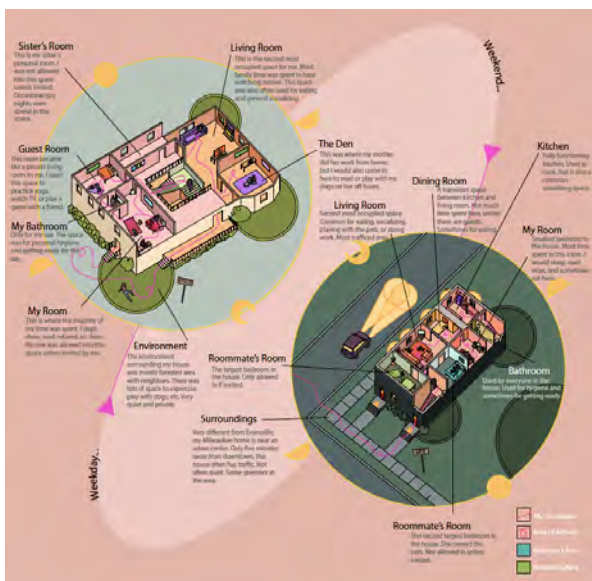
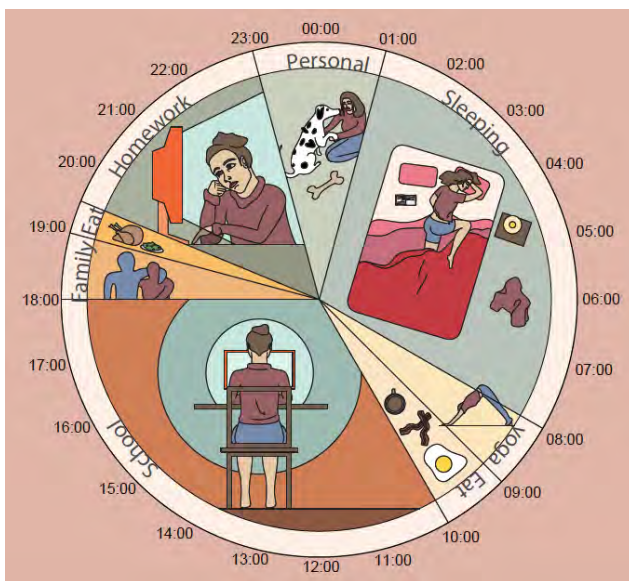

FIG. 1 AND 2: Klopp's weekday spatial clock diagram in her parent's home, Spring 2020. Klopp's spatial mapping inside her parent's home and in her Milwaukee home, Fall 2020. Source: Klopp in the ARCH 302 course, Spring 2021

4.3 A Student of Rohingya Lineage in Her Early 20s

Abdul Manan, a junior undergraduate architecture student of South-East Asian Rohingya minority lineage, immigrated to the United States eight years back. Her narrative begins with reminiscences from her pre-pandemic times in the architecture studio spaces as she used to enjoy being around her friends and share the work stress under the same roof. She also mentions the lack of physical activity and issue with a concentration in studying during her pandemic stay inside the home as she states, “Working from home can be both good and bad... Over the time I am getting used to staying at home and trying to reorganize the space in a way that I can stay all day and study, do some physical activity once a while so that I can stay focused.” Abdul Manan’s narrative and drawings confirm her family of six members living in a two-bedroom apartment in the south side of Milwaukee, which seems to be quite congested even at a situation when they would go in and out for attending jobs and schools. Abdul Manan shares a bedroom with her five-year-old daughter and mother, while her two brothers and father live in the other bedroom or the living room. She mentions the space as “noisy with little privacy,” due to her difficulty concentrating in the study as her siblings would be attending an online school, and her father would be watching television in the same space. She even attempted to set up a study space in the basement, but the plan failed as that space was without heat and daylight. From Abdul Manan’s spatial mapping inside her domestic space, it is evident that her main challenge during this spatial constriction was to manage her own space to study in a concentrated manner. At the same time, she associates these new normal times with “feelings of loss and isolation” as she mentions, “Studying architecture can be stressful but I miss the memories of working in the studio space— making architectural models while listening to music, preparing for presentations, rushing to print posters, or going out with friends for a site-visit. Now, I feel less motivated in study as I am not able to ask questions and receive feedback directly.” During the Fall 2020 semester in the SARUP, Abdul Manan mentions that she was very excited to be back to work in the school’s studio space again, even though they were at least six feet apart from each other and wore a mask all the time. However, in the middle of that semester, COVID-2019 infected cases started to rise again in Milwaukee. Due to health safety reasons, all the UWM classes switched back to virtual learning mode.

4.4 A Student of Caucasian Lineage in Her Late 20s

Horwath started her graduate school in the SARUP in the Fall of 2020, in midst of this ongoing COVID-2019 pandemic. Before this journey began, she had to go through several spatial displacements in midst of this pandemic. In her narrative, she explained how the COVID-2019 experiences have reterritorialized her sense of home in particular, in between these shifts of spaces. Throughout her spatial mapping diagrams, she used the “proxemics” concept to explain how the physical proximity of others played a role in her circulation patterns.

Once the pandemic landed in the U.S. in during the mid-March of 2020, Horwath and her partner drove all the way from Utah to Milwaukee, to her parent’s home. They packed their bags with emergency necessities and drove for twenty-eight hours. On this long journey, they took only one two-hour “napping break” inside their car while being parked in a diner parking lot. Before meeting her parents, they quarantined for two weeks, and in midst of all these happenings, Horwath was teaching Ceramic lessons online. Her feelings about moving back to her childhood home is expressed aptly when she says, “I went from having my own place in another state to sharing living boundaries with three others.” Eventually, she recognized the spatial patterns of others (FIG. 3) intersecting at the common spaces of the house, and established her territorial control.

During the Summer of 2020, Horwath’s perspective on life became settled through a pandemic lens. She notes, “My life’s focus shifted to a recognition that being near family is more important than adventure-seeking. After living in Utah for three years teaching, hiking, and snowboarding, it was time to pack things up and move home to Wisconsin.” During these times, she also became more adapted to route her circulation patterns along with her partner. They went back to Utah again in the early-Summer to pack their stuffs and sell their belongings there before moving back to Milwaukee permanently. Throughout Horwath’s narratives, it is interesting to notice her struggles to establish her territorial control around new places and family members, while re-routing her life experiences from a renewed perspective.

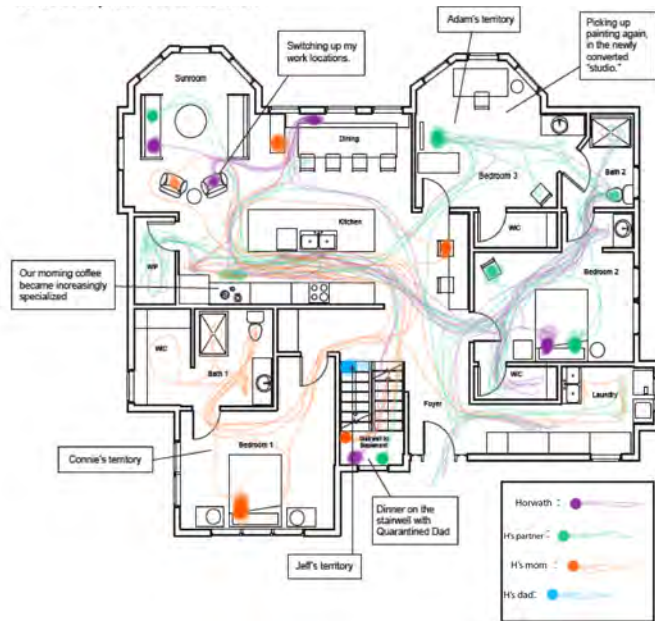

FIG. 3: Horwath's spatial mapping inside her childhood home, along with her partner and parents, in Spring 2020. Source: Horwath in the ARCH 302 course, Spring 2021

4.5 A Student of Caucasian Lineage in Her Early 20s

Bauman, a junior undergraduate architecture student of Caucasian lineage, talks about her shifting experiences of living in different spaces throughout the pandemic in 2020 and how that shaped her notion of comfort and belonging within every context. Right after the initial onset of the pandemic in mid-march, she left her space at the UWM Residence Hall and moved to live on a mattress pad in the living space of her friend's apartment till the end of April. During that period of living within a shared space, one of her significant challenges was maintaining her privacy and necessary belongings in a single space. She talks about how her displacement without any privacy or attachment in space put her in a "limbo" phase. During this time, much of her motivation for schoolwork decreased as her studying areas were all communal areas and fluctuated between the same places where she would eat and sleep.

From May till July, Bauman moved into a shared apartment, and she was relieved to get her spatial privacy back to some point. Her wellbeing became significantly improved since the time she was living in a space that lacked complete privacy. In this new space, she was sharing with a woman and her dog that she had not known earlier, and they were sharing all the common spaces except the bedrooms. From August till the end of 2020, Bauman moved again into a new two-bed apartment before the school began. This time, she was sharing the bedroom space with her boyfriend, and they had enough room to create their study zones. Bauman states the positive changes in the new space as she received a constant companion to share happiness and stress. She notes the positive impact of putting greenery and aquatic species in her new space as she says, "Throughout our apartment, there are six variations of aquariums that contain freshwater fish, shrimp, and African dwarf frogs. My roommate owns a lot of plants, so our space is very green." She also emphasizes having a great view outside her desk for her wellbeing when she felt overstressed to keep a balance between her full-time job and study. Throughout the three seasons in the pandemic, Bauman's spatial mapping [Figure6] clearly describes her position in different forms of shared spaces and the spatial characteristics that put her in the sense of discomfort or harmony.

4.6 A Student of Caucasian Lineage in Her Early 20s

Kuehl, a Senior-level undergraduate architecture student, poses an interesting spatial perspective through her workspaces during the three seasons of the COVID-2019 pandemic by describing the sensory details and activities around her workspaces in three different locations. In this way, she reflects how she dealt with her pandemic anxiety by gazing outside her workspace and appreciating the views from the window. Throughout her workspace descriptions during the three seasons, she mentioned the regular work breaks by getting outside for a walk or stretching out for a while, after sitting on the workspace for long hours.

Kuehl had to leave the UWM Residence Hall and move back to her parent's residence once the pandemic shut out all physical contacts. Earlier the pandemic hit, she reminisces the gorgeous view of Lake Michigan and the morning sun around her workspace, from the twelfth floor of her Residence Hall room. After the shift to parent's home, her new workspace became transferred to her childhood bedroom. The work desk was located in front of the room's window from where she had the soothing view of a large Oak tree outside and could hear birds chirping. During that Spring, she spent the majority of her time working at that desk. She also talks about the dining table in her parent's home and

their relaxing family times with lunches and dinners together. At the beginning of June, she moved back to Milwaukee and started living in a shared apartment. In this new setting, her bedroom became her main workspace for the Summer internship and night classes. The room is at a unique intersection of public/ private territory within the unit as it is located alongside the shared back porch [Figure 7]. Kuehl brought the same work desk from her parent's home that she used since childhood and set it up in a way that could provide a view of their neighbor's backyard garden. While working, she could watch her neighbor tending the garden and watched the crops growing throughout the Summer months. In the Fall of 2020, Kuehl joined an in-person studio in the SARUP and relished the presence of her classmates and the new organization of space for maintaining physical distance. Eventually, she decided to spend most of her study and research time at home as her bedroom space became her comfort zone during this pandemic. Throughout Kuehl's spatial mapping of workspaces, it is interesting to see the pattern of how she had always considered "great view" as a primary element of her wellbeing and was directly connecting that to her level of productivity in her workspace.

5.0 EVALUATING CREATIVITY OF THESE SPATIAL MAPPING ASSIGNMENTS

From these narratives and mappings presented here, it is evident that each of the female participants had unique spatial experiences and circumstances during this COVID-2019 pandemic. The participants also adopted diversified ways of representing and mapping their spaces and activities. The submission requirements in this course assignment was laid out in several phases in a straightforward manner. In the first phase, they wrote a 1000-word narrative about their transformation of experiences throughout the three seasons and laid out the research question. They also created a graphic cover of their assignment that visually narrates their circumstances during these pandemic times. In the subsequent three phases, they laid out spatial activities inside and outside of their residence/s. These phases covered a particular season (Spring- Summer- Fall 2020) during the ongoing COVID-2019 spatial restrictions. In the final phase, the students compiled their spatial mappings throughout all these seasons and made the adjustments and corrections received from their earlier phases. Besides narratives, they created plan drawings, diagrams, collages, and other visuals to record their spatial movements and emotions. Similar to Horwath's one, some of the assignments recorded spatial activities of their living partners along with theirs, as the mapping was interloping. While introducing the assignments and its objectives, I laid out the guidelines while leaving adequate space for their creative freedom.

One of the primary evaluation criteria for this assignment was that the produced drawings and illustrations should be self-explanatory enough to explain the student's everyday spatial mapping and transformations through these seasonal changes. Legibility and clarity in the drawings, images, and narratives were ensured to become a primary goal for these mapping exercises. The use of architectural grammar was highly prioritized to achieve this clarity of expressions in their spatial experiences. The students were encouraged to share their works in smaller discussion sessions. Finally, all the student works were closely monitored to check their advancements through each phase where academic honesty and integrity were highly prioritized. Throughout the five phases, the student works were organized under three major grading categories, which are "Excellent," "Very good," and "Average." The student works that are showcased here are chosen from all these three categories. Those who followed the suggestions and guidelines throughout the course could achieve to remain in the upper two grading categories.

6.0 ANALYSIS AND FINDINGS

These pandemic spatial experiences of the six female architecture students describe several characteristics that come in common, such as the feeling of uncertainty, dispossession, and isolation. First, the upsurge of pandemic anxiety and confusion is heard throughout these female voices, and these emotions are reflected significantly in their spatial experiences during this time. To cope with this "new normal" situation, most females mentioned their affinity to nature through sensory and physical presence. Horwath, Kuehl, Klopp, Lopez, and Bauman repeatedly noted how a good view from their bedroom window or a walk into nature made them immediately feel better about themselves. Second, displacement from their regular living conditions is another typical pandemic chronicle found through these voices. Except for Lopez and Abdul Manan, the rest had to tackle dispossession of their domestic spaces due to the pandemic. Bauman, Klopp, and Kuehl mainly talked about giving them a one-week notice to evacuate their room in the UWM Residence Hall. Horwath notes the harrowing experiences of driving from Utah to Milwaukee with her partner right after the pandemic breaks in the USA. Bauman describes how she felt "out of place" without any privacy by moving to her friend's living space during the Spring season, while Kuehl and Klopp went back to their parent's homes and had to adjust their spatial boundaries to live along with their family members. These females mentioned setting up their spatial privacy as a significant challenge during this pandemic spatial constriction within their domestic spaces. Third, even though these participants stated the lack of privacy and personal boundary as a substantial issue, they also mentioned social isolation as a significant downfall of their pandemic spatial experiences. Abdul Manan, Klopp, and Kuehl briefly stated how relieved they were to be back to the in-person SARUP studio spaces to socially communicate with their classmates while maintaining a safe physical distance. Abdul Manan discussed the disruption in her architecture education for not meeting her instructors in a classroom setting and the lack of a proper study space inside her parent's home. Horwath talked about her newfound sense of belonging in the city of Milwaukee and her parent's house amid several spatial displacements. These females mentioned at least one companion in their pandemic living with whom they were comfortable sharing their spaces. Horwath and Bauman mainly referred to the "Black Lives Matter" movements as part of their summer activities to attend in Milwaukee. From their narratives and spatial drawings, it is fascinating to explore the common threads of solaces and malaises in their pandemic living experiences and the varied ways each of them addressed these issues in their surrounding built environment.

CONCLUSION

Within this scope of the study, it can be said that each of these spatial narratives catalyzes further dialogue, debate, and research on the intersections of the COVID-2019 pandemic and the female experiences within their surrounding built landscape. This paper analyzed and compared the participant's positive and negative spatial experiences, particularly within their domestic spaces, and how they shifted as the pandemic advanced through different phases, along with seasonal changes. These participants explored their renewed relationships with their surrounding places and people in their unique ways during these challenging times. Despite the difference in their backgrounds and circumstances, their spatial emotions often intersected at several common points through their pandemic anxieties, displacement, social isolation, physical distance, and lack of personal boundary.

This was my first experience as an instructor teaching a course related to architecture and human behavior, and I would say that I learned a great deal from my students. I would also share my sincere gratitude to the three teaching assistants and two peer-mentors who closely worked with the students— Samuel Giglio, Laura Wilk, Alexis Meyer, Maysam Abdeljaber, and Taylor Romanyk. We all appreciated the diversified and thought-provoking approaches taken by the students in portraying their spatial mappings. I would also suggest that the students took a personal interest in this project as they described their experiences during a challenging time. I also noticed that, on average, the females were using more details in mapping their experiences and emotions than the males in the class. Many of the students exclaimed that their spatial experiences during these times would probably leave a more significant imprint in their post-pandemic spatial experiences.

BIBLIOGRAPHY

- Alstott, A. L. 2020. Mothering in a Pandemic. In: D. Chasman and J. Cohen (eds.) *The Politics of Care: From COVID-19 to Black Lives Matter*. Cambridge, MA: Boston Review, 134-143.
- Altman, I. 1975. *The Environment and Social Behavior*. Monterey, CA: Wadsworth Publishers.
- Beebeejaun, Y. 2016. Gender, urban Space, and The Right to Everyday Life. *Journal of Urban Affairs*, vol. 39, issue 3, 323-334.
- Daphne, S. 1992. *Gendered Spaces*. Chapel Hill, NC: University of North Carolina press.
- Dovey, K. 1985. Home and Homelessness. In: Altman I., Werner C.M. (eds.) *Home Environments. Human Behavior and Environment (Advances in Theory and Research)*, vol. 8. Boston, MA: Springer Publications, 33-64.
- Edney, J. J. 1976. Human territories: Comment on functional properties. *Environment and Behavior*, 8(1), 31-47.
- Grosz, E. 1994. Women, Chora, Dwelling. In: J. Blummer (ed.), *Architecture and the Feminine: Mop-up Work, no 4*. New York: Anyone Corporation, 22-27.
- Irigaray, L. 1985. *Speculum of the Other Women*, trans. by G. C. Gill. Ithaca, NY: Cornell University Press.
- Lang, J. 1987. *Creating Architectural Theory: The Role of Behavioral Sciences in Environmental Design*. New York: Van Nostrand Reinhold.
- Oldenburg, R. 2002. *The great good place: Cafés, coffee shops, bookstores, bars, hair salons, and other hangouts at the heart of a community*. Philadelphia: Da Capo Press.
- Rapoport, A. 1990. Systems of Activities and Systems of Settings. In: S. Kent (ed.) *Domestic Architecture and the Use of Space: An Inter-Disciplinary Cross-cultural Study*. Cambridge: Cambridge University Press.
- Zubaidi, F. 2019. Types and Patterns of Territory in the Traditional Settlement of Ngata Toro. *Architecture & Environment*, vol. 18, no. 2, 123-134.

Minimal Residency Doctoral Education

Neil Leach¹

¹Florida International University, Miami, FL

ABSTRACT: Traditionally, architectural education has pursued a parallel route to other disciplines, whereby the time taken to complete professionally accredited architectural education has mirrored that taken in other disciplines to undertake education to a doctoral level. As a result, few architects have pursued doctoral education. However, a doctorate has become the minimum requirement for professorial academic appointments in some countries, while the growing emphasis on research output has increased the demand for research-based training associated with doctoral education. The question of how to offer doctoral training for in-post academics has therefore become a pressing challenge. This paper documents the emergence of a new model of doctoral education within architecture, the minimal residency program. It outlines the structural logics of three examples of such programs – one in Europe, one in China, and one in the States – that have permitted in-post academics to pursue doctoral education, while allowing them to maintain their academic appointments elsewhere. This paper concludes that it is impossible to make any definite evaluation or comparison of these three programs, given their fundamental incommensurability in terms of conditions, fees, length of program and so on. Nonetheless, it is possible to track how collectively these three programs have introduced a range of innovative strategies that developed an initial model through a series of iterative innovations and revisions, and have opened up new possibilities for doctoral education, and that look set to be developed further in a post-Covid era of online education.

Keywords: Minimal residency, doctorate, residential component, computational design, in-post academics

INTRODUCTION

Minimal residency doctoral education is still in its infancy. There are few academic papers published on the subject, and nothing, it would seem, on minimal residency architectural education. Moreover, what has been published on minimal residency doctoral research in general has tended to focus on the challenges of such enterprises. [Terrell et al.] This paper will attempt to track the development of a particular model that has gone through a series of iterations, and that is now – arguably – outlining a recognizable alternative approach to full time, full residency doctoral research. It does so, partly with the ambition of initiating a discourse on the subject, not despite of the fact that there is so little material published on the subject, but rather precisely because of the fact that there is so little published. What has become clear is that there is a growing expectation for doctoral qualifications before academic appointments in most countries, and that it has become an absolute requirement in some countries, such as China. [Wang et al.] We can only expect this trend to continue. Research into this field is therefore very necessary.

To be clear, what is being presented here is not a model that would work well as a substitute for the standard model of doctoral research, where a researcher operates within a fixed physical space, such as a laboratory, and works on a large-scale funded research project in close proximity with a group of colleagues on a day to day basis. Rather, what is being presented here is an alternative model, based on an individual researcher who has a proven track record of research publications, and who is anxious to consolidate that knowledge, build upon it, and have it recognized as meeting the standards of doctoral research. There are many ways to produce a doctoral thesis, just as there are many ways to design a building. This, then, is one of the more unconventional approaches, and yet it is becoming an increasingly popular pathway for achieving doctoral qualifications.

LONDON CONSORTIUM

Where does any idea have its origins? The origins of an idea – link the origins of a river – are perhaps not so easy to discern. From a personal perspective, however, the need to consider a new form of provision of doctoral education became apparent, when a number of graduates from the Design Research Laboratory [DRL] Masters program at the Architectural Association [AA] program in the early 2000s began to enquire about the possibility of doctoral supervision. The AADRL is a very intensive program, and after 16 months of intense study, students could be said to be almost halfway towards a PhD. By that time, other post-professional masters programs addressing innovative new technology had also been launched at Institute of Advanced Architecture of Catalonia [IaaC], Dessau Institute of Architecture [DIA] and other programs at the AA, such as the Emerging Technologies and Design [EmTech] program.ⁱ

However, the only obvious doctoral pathway with sufficient resources for a graduate of such programs at that time was the London Consortium [LC], which was founded in 1993 by Paul Hirst, Mark Cousins, Richard Humphreys and Colin McCabe. [Cousins] The LC was disbanded in 2013. The LC an innovative new program, that (at various times) drew upon the resources of a number of institutions, including the AA, Birkbeck College, Tate Galleries, Science Museum, British Film Institute and Institute of Contemporary Arts, together with the supervisory contributions of a range of academics from other institutions. [McCabe] The degree was validated by the University of London.

An interesting aspect of the LC was the fact that the program itself was nomadic, despite the fact that it involved institutions operating within fixed physical spaces. The LC had no physical base, and events were often held in rented venues, such as the back room of pubs. The significant limitation of the LC program, however, for graduates of programs, such as the AADRL, was that it focused on the humanities, and did not address computational design. Nonetheless the LC constituted a potential template for a nomadic or minimal-residency doctoral program in computational design, involving academics from more than one individual institution that spawned a number of iterations.

DIGITAL CONSORTIUM PHD PROGRAM

The first potential iteration in this process to develop a doctoral program in Computational Design, the tentative Digital Consortium (DC) PhD program was never fully realized, but nonetheless provided a model for doctoral education that eventually was to prove successful elsewhere. The DC went one step further than the LC, recognizing that not only did the subject matter not need to be limited to the humanities, but also that a consortium did not need to be limited to one country. In fact the vision of the DC was based on the principle of aircraft construction, explored by Airbus Industries, for example, which itself involved a consortium of manufacturers in different countries; an aircraft, after all, could be composed of different parts fabricated in many different countries, and assembled in a further country. [Slutsken] The model of the consortium, furthermore, was also articulated within the air travel sector, where a number of airlines had established three different alliances, as a collaborative structure aimed at pooling resources. [Riva] The DC also recognized the fact that no single architectural institution – with the possible exception of computationally advanced institutions, such as MIT – had sufficient academic resources in the relatively new doctoral field of computational design to provide comprehensive doctoral supervision. A model of shared cooperation in this field therefore made considerable sense.

The DC was to be based on a potential collaboration between two primary constituent parties, the University of Brighton [UoB] and laaC, supplemented by a number of guest instructors, consisting of other prominent academics within the field, drawn from other institutions. The UoB would validate the degree, while laaC would supply the advanced design impulse of one of the most dynamic design schools in the world. In the end, proposals for the DC collapsed because of administrative concerns about risk management. In particular, the UoB was concerned about the financial standing of its potential partner, laaC, and therefore requested to take charge of all decisions regarding management, including the design of all promotional material, a request that was not acceptable to laaC. Eventually the proposal was withdrawn and not implemented.

EUROPEAN GRADUATE SCHOOL PHD PROGRAM

The next iteration of this potential model was the establishment of a new 'stream' within an existing PhD program at the European Graduate School [EGS]. The advantage of this platform was that it was a PhD program already in place. Furthermore, the EGS had a strong international reputation in the field of Continental Philosophy, and counted among its present and past faculty luminaries, such as Jacques Derrida, Jean Baudrillard, Slavoj Žižek and Judith Butler.ⁱⁱ The disadvantage of this platform was the somewhat controversial validation of its degrees.ⁱⁱⁱ Also – as subsequently became increasingly apparent – there was some opposition to computation within the EGS hierarchy, especially following the restructuring of the institution in 2014, and the appointment of a new dean of the Division of Philosophy, Art and Critical Thought, Christopher Fynsk.^{iv}

What makes the EGS interesting in terms of its structure is that it takes the nomadic character of the LC one step further. If the LC was nomadic in terms of its venues, at least it had some physical institutions among its lineup. The EGS, on the other hand, operated in the Swiss village of Saas-Fee for 3 week residential sessions during the summer months – settling somewhat like a butterfly in the highly picturesque location briefly each year. This arrangement worked well for the ski resort of Saas-Fee in terms of generating income during the skiing off-season. Meanwhile, the EGS merely rented accommodation for the residential sessions, thereby avoiding building maintenance and other costs for permanent facilities, and hired faculty to teach 3 days of intense seminars, attracting them with a relatively generous honorarium that served to supplement their main academic salary.

The new Digital Design PhD stream was launched in collaboration with then EGS Provost, Hubertus von Amelnunxen.^v The EGS program is supported almost entirely by academic fees. As such, anyone who applied would stand a very high chance of admittance. However, what became clear is that not only did the applicants self-select, but they also demonstrated that there was a market of applicants for such programs, consisting of tenure track faculty, drawn largely

from the States. The primary attraction for US academics, it would seem, was the availability of loans, and the fact that the program had a long list of illustrious instructors and the residential component took place during in the academic summer vocation in a highly idyllic location. At the same time, the minimal residency allowed candidates to conserve financial resources by maintaining their main source of income, while not having to pay for additional accommodation and travel, apart from their annual residential session in Saas-Fee. There are, of course, challenges with minimal residency programs such as these, but equally, it would seem, there are some advantages. [Terrell et al.] Current fees for a PhD at the EGS amount range from USD 24,600 (3 years) to USD 30,600 (5 years).

Eventually the stream evolved to consist of two different disciplinary fields, Computational Design and Architecture + Philosophy, alternating each year. In both fields it boasted a distinguished lineup of professors, including Achim Menges, John Fraser, Alisa Andrasek, Francois Roche and Philip Beasley in Computational Design and Sanford Kwinter, Benjamin Bratton, Keller Easterling and Patrik Schumacher in Architectural + Philosophy. In terms of academic validation, students were required to merely attend the lectures and take notes. However, there were no requirements to submit any essays, apart from the final doctoral thesis required for graduation.

Despite the success in gathering an impressive lineup of faculty and students and the attraction of the idyllic scenery of a Swiss mountain village, however, the stream did not last long. The incoming Dean, Christopher Fynsk, opposed the idea of what he interpreted as a separate 'professional' stream, even though several of the professors, and most of the students did not have a professional background in architecture, and dissolved the stream into the broader curriculum in 2015.^{vi} Some professors have still been retained for the broader curriculum.

DigitalFUTURES INTERNATIONAL PHD PROGRAM

The next iteration of this model was the DigitalFUTURES International PhD program launched by the College of Architecture and Urban Planning [CAUP], Tongji University, Shanghai, in June 2016.^{vii} This again started on a positive note. The then Dean, Dean Li, had already embarked on an aggressive campaign of international exchange programs, and a new PhD program, building upon the success of the DigitalFUTURES annual program of free workshops and conferences, seemed to be the ideal step in opening up CAUP – currently ranked number 13 in the world for architecture – to further international collaboration.^{viii} The model adopted was almost identical to the EGS minimal residency program in terms of residential requirements and salaries for guest professors. It was also decided to make the PhD free for students, in keeping with the overall policy for DigitalFUTURES events. Unfortunately, however, this program was an international program and was not available to applicants from mainland China, despite the fact that a PhD is a requirement for any professorial appointment in China.

The program attracted an even higher caliber of applicants. 10 doctoral candidates were selected, including full and part time faculty in leading universities, and graduates from leading schools of architecture, including the Architectural Association, Harvard GSD and the University of Pennsylvania. The lineup of faculty followed the EGS model. Professors invited included Achim Menges, Roland Snooks, Mark Burry, Mette Thomsen, Areti Markopoulou, Jenny Sabin, Mike Xie and Patrik Schumacher. Significantly the DigitalFUTURES International PhD program showed that these high profile programs could operate in non-Western countries.

Once the program had been launched, however, challenges began to present themselves. The first challenge was that the category of a 'minimal residency' PhD research is not officially recognized in China. This required a form of camouflage tactic, where the program was presented as a full time program, but instruction took place only during a highly intensive 3 week period, modeled closely on the EGS model. The second challenge was that, while CAUP could offer partial scholarships to cover the cost of fees, eventually it could not guarantee to cover the full cost of these scholarships, especially as this sum would mount over the years as more students were accepted.

Further challenges also presented themselves. It transpired that the way that the students would have to cover a portion of their fees initially, and would be reimbursed later. However, the process of transferring financial sums to parties outside of China proved to be a complicated and slow process. A further challenge was presented when Tongji introduced visa checks and facial tracking cameras that made the minimal residency aspect of the program even harder to conceal.^{ix} A more recent challenge has occurred with the change of dean at CAUP, and the withdrawal of financial support. Accepted PhD students are now expected to pay RMB 45,000 (c. USD 7,000) per year.

Given all these challenges, the intake of International PhD students has now dwindled, with only one international student being accepted since 2019, and with only 5 of the overall intake of 10 students remaining. Prospects for reviving the program look slim.

FIU DOCTOR OF DESIGN PROGRAM

A further iteration of the model of minimal residency doctoral education is the Doctor of Design (DDes) program at Florida International University [FIU].^x This follows the EGS and DigitalFUTURES model, with the residential component being held at the FIU Miami Beach Urban Studies [MBUS] facilities. FIU regulations, however, prevent the

full program of teaching from being accommodated within the 3 week residential component of the two previous models. Instead, the program was launched as a 70% online program with only 30% of instruction taking place in person in Miami Beach during two 9 day residential periods - one each semester.

The instructional components of the FIU DDes program also follow a similar model to both the two previous models, with a focus on Computational Design and Philosophy. There are, however, additional courses in Miami Urban Studies that encompasses a series of local preoccupations related to the social and cultural life and ecological conditions of Southern Florida. The latter has proved to be a significant draw, and is an ever-present concern for residents of the region given the problems of sea-level rise posed by global warming.

One important innovation, however, has been the possibility of including 15 credits from the Masters course towards the doctorate, thereby reducing the total from 60 credits required to 45 credits. This allows the DDes to be completed within 2 years. It has proved challenging, however, for the candidates to complete their degree on top of their commitments to regular employment. The other challenge has been the cost of fees, which at over USD 45,000, are significantly higher than the other two models, despite the fact that the degree is shorter. This has caused a few candidates to withdraw.

The FIU DDes was launched in January 2020, during the Covid-19 pandemic. This proved highly significant, in that the planned residential sessions in Miami Beach could not take place in the first semester of the program, and were further restricted by quarantine requirements in the second semester, so that not all students could attend. Nonetheless, the necessity of operating online, allowed the program to draw upon the newly discovered benefits of online teaching, bringing in instructors from all over the world, and exploiting the potential of a global platform. This has also allowed the program to partake of the Doctoral Consortium initiative launched by DigitalFUTURES, an initiative aimed at creating a shared platform for doctoral scholars throughout the world, which from a logistical standpoint, takes the initial model of the LC, DC, EGS and DigitalFUTURES one step further.^{xi} Indeed, the online nature of the program has offered certain unexpected advantages. As a result, the residential sessions at Miami Beach have now been curtailed for financial reasons, and the FIU DDes is now potentially fully online.

CONCLUSION

How, then, are we to evaluate the respective merits of these three different, yet related programs? They all adopt the model of minimal residency, address similar subject areas and appeal to a broadly similar market, consisting largely of research active academics, already in post and in need of a doctorate for career advancement. At the same time, they are all different, and not simply because one operates up a mountain, one in the most populated cities on the planet, and one by the beach. After all, they each operate within different financial constraints. They each have different lengths. They each have different bureaucratic constraints imposed by their host institutions. The more that you compared seemingly similar models, it would seem, the more that you recognize their individual differences. As such, it would be almost impossible to draw up any meaningful evaluation and comparison of these three different programs. In any case, such a comparison would need to take into account other examples of non-residential programs in existence, in order to offer a truly comprehensive analysis.

At the same time, the opposite is also true. The more that you contrast these different programs, the more that you recognize their overall similarities. Collectively, these three programs point towards an emerging market for minimal residency programs. Despite the challenges faced by each institution, each new program constituted a different iteration, a further revision to the original model, updating and improving that model. The EGS PhD program has established that there is indeed a market for non-residential programs from academics already in post, who are able to retain their salaries, and avoid paying for additional accommodation and travel, apart from the residential sessions. The DigitalFUTURES one has shown that this model can also work to some extent even in a non-Western country. Finally, the FIU DDes has shown that it is possible to use 15 credits from a previous Masters program to count towards the 60 credits of a doctoral program, so as to reduce the cost and the length of a doctoral degree. So, too, it has helped to expose the emerging potential of online education. As has become clear during the Covid-19 pandemic, online education has much to offer, and is well suited to an international audience.

What an exercise of comparing these three doctoral programs reveals, then, is not the superiority of any one particular model – since the three models are largely incommensurable – but rather an emerging model for minimal residency doctoral education that has already gone through a series of iterations, and looks set to go through a series of further iterations. Collectively, they seem to establish that the new minimal residency model would appear to constitute a viable alternative to the traditional, fully residential, full-time model of doctoral education.^{xixxii} Despite the challenges, then, it would appear that minimal residency doctoral education is here to stay.

REFERENCES

- Cousins, Mark (2003). 'Paul Hirst and the London Consortium.' Open Democracy, <https://www.opendemocracy.net/en/1360/>
- McCabe, Colin (2000). *Critical Quarterly*, 42, No. 2 (Summer 200), Special issue on the London Consortium
- Riva, Alberto (2021). 'What air airline alliances, and who is in them?' *The Points Guy*, 2 April 2021, <https://thepointsguy.com/guide/airline-alliances/>
- Slutsken, Howard (2018). Four Million Parts, Thirty Countries: How an Airbus A380 comes together, CNN, 28 December 2018, <https://www.cnn.com/travel/article/airbus-a380-parts-together/index.html>
- Terrell, Steven R., Martha M. Snyder, Laurie P. Dringus, and Elizabeth Maddrey. "A grounded theory of connectivity and persistence in a limited residency doctoral program." *Qualitative Report* 17 (2012): 62.
- Qi Wang, Yi Li, Nian Cai Liu (2015) 'Conditions and Opportunities for New Faculty in Higher Education in Mainland China in In Young Faculty in the Twenty First Century: International Perspectives. Albany, NY: SUNY Press.

ⁱ <https://iaac.net/>; <https://www.hs-anhalt.de/nc/en/study/orientation/degree-programs/detail/architecture-dia-master-of-arts.html>;
<https://emtech.aaschool.ac.uk/>

ⁱⁱ <https://egs.edu/faculty/>

ⁱⁱⁱ The EGS program is licensed as a university in Malta, where some of the tuition now takes place: https://ncfhe.gov.mt/en/register/Pages/list_universities.aspx. However, it is not recognized by the Swiss University Conference, the main regulatory body for universities in Switzerland: <https://www.swissuniversities.ch/en/topics/studying/recognised-or-accredited-swiss-higher-education-institutions>

^{iv} <https://egs.edu/biography/christopher-fynsk/>

^v <https://egs.edu/biography/287/>

^{vi} The following year Fynsk offered a course in 'Handicraft'.

^{vii} <https://digitalfutures.tongji.edu.cn/>

^{viii} <https://www.qschina.cn/en/university-rankings/university-subject-rankings/2021/architecture-built-environment>

^{ix} This challenge was alleviated somewhat by the onset of Covid-19 pandemic, when teaching went online, and physical attendance was not required.

^x <https://carta.fiu.edu/architecture/academics/degrees/doctor-of-design/>

^{xi} <https://www.digitalfutures.design/fall-2021>

^{xiii} The fulltime model, however, has perhaps never been completely fulltime, in that doctoral students are often obliged to undertake a certain amount of part-time teaching and other employment to help cover the cost of tuition.

A New DDes Program in Architecture at Florida International University focusing on Technology and Sustainability

Gray Read¹, Shahin Vassigh¹, Biayna Bogosian¹

¹Florida International University, Miami, FL

ABSTRACT: The mandate for a sustainable future in the context of rapidly changing technology is redefining design, opening opportunities for architects to lead sustainability efforts across the built environment. In addition, technology is automating many tasks, and opening new avenues for architects to act. According to the World Economic Forum, “sustainable production and robotics are strong drivers of employment growth in the Architecture and Engineering job family, in light of a fast-growing need for specialists to create and manage advanced and automated production systems”. To address these converging conditions, architects are challenged to integrate ideas across different fields with a global perspective in order to approach local issues with specific environmental, social and ethical complexities. To meet the moment, doctoral education is increasingly necessary to foster space and time for developing the highest level of critical thinking and innovation within the profession. This paper presents a new Doctorate of Design Program at Florida International University designed to address some of these challenges and opportunities. This two-year hybrid program provides a venue for self-directed interdisciplinary research with a flexible residency requirement. An essential aspect of the program is an emphasis on theory and practice-based research to address the challenges of sustainability and technological innovation. In addition, the residency component provides an opportunity for collaborating on interdisciplinary projects using the state-of-the-art robotic facilities and engage collaborative research with the FIU Institute of Environment. Remote learning is supported by an alliance with the Digital Futures ongoing series of lectures. Students from around the world engage each other in synchronous discussion classes, while pursuing independent research projects in their local cities. This global/local structure has the potential to become a model.

KEYWORDS: Doctoral Education, Digital Futures, Robotics

INTRODUCTION

A new Doctorate of Design (DDes) program joins several other new post-professional programs designed to lift the level of discourse in Architecture to meet the challenges of increasingly rapid global change. Florida International University’s DDes focuses on two transformative changes in our field: fast-evolving technology, which is fundamentally shifting the role of the designer in relation to both client and construction, and the monumental challenges of sustainability and resilience, which are changing the role of buildings within an interconnected ecosystem. Both conditions require architects and educators with sophisticated research skills and a broad base of knowledge to respond to change and to invent within a new milieu. The skills and perspective that doctoral-level research can bring to the field include the ability to critically analyze problems and challenges, define meaningful questions and invent a way to address them, as well as to communicate effectively with others outside of the field - all of which may or may not involve building design.

This paper expands on the need for doctoral education in architecture and some of the inherent challenges, then explains how FIU’s doctoral program builds on liaisons with two groups: Digital Futures, an open, online platform for presentations and discussions on architecture and technology, and FIU’s Institute of the Environment, which supports interdisciplinary research, interactive education, and public engagement.

1. Preparing for Technological Change

Emerging technologies including machine learning, robotics, digital fabrication, sensors, and immersive environments are changing the landscape of research, innovation, design, and production. Intelligent machines are expanding human physical capacity while augmenting work in a broad range of endeavors and businesses in manufacturing, architecture, construction, education, building design, and engineering. These technologies are no longer the province of large corporations and institutions but are becoming prevalent in small businesses and organizations. It is expected that they will become ubiquitous - a competitive necessity for large and small organizations across the economy.

Design conceptualization has powerful generative tools, including artificial intelligence that are transforming the process of design and challenging the image of the architect as an autonomous creator. The ability to optimize parameters and generate alternatives comprehensively and instantly has tremendous potential for making buildings more efficient and responsive. Analysis is also enhanced, allowing architects to evaluate choices effectively, thus recasting them as designers of the process rather than a specific outcome. Definable issues can be resolved efficiently, but the more complex integration of social, cultural, and expressive intent is more difficult to reduce to an algorithm. Ideally this shift should allow architects the time and tools to think at a higher level about the underlying values of the project, a creative stewing time when design decisions are refined with sophistication and intention into synthetic works that contain the most human art.

Many researchers foresee that demands of the new workplace will skew toward more personal interactions, collaboration, and higher levels of cognitive capabilities (Kivunja 2014). They argue that while technical and specialized skills will remain important, the ability to engage in critical thinking, a high level of problem solving, and teamwork will be in high demand. In addition to these skill sets, the ability for interdisciplinary collaboration, critical analysis, and creative thinking are increasingly important. In short, the principal domain of the architect becomes focused on the human part of design, including a holistic understanding of the issues, which informs truly synthetic invention, and leadership, the art of organizing and inspiring people.

Developing technology also brings research opportunities, which include not only design investigations, but studies of how new techniques open new ways that buildings can work. Smart technology and the internet of things as well manufacturing and off-site construction processes are narrowing the divide between building and device. Virtual reality, augmented reality and interactive design each open opportunities for design experimentation and research.

These rapid advances in technology are introducing new challenges to educators charged with preparing students for success in the automated economy of the future. FIU's DDes program invites students to engage technological innovation through discussions with architectural innovators on the Digital Futures platform and through hands-on experimentation in robotics and fabrication labs (Figure 1). The FIU program director, Dr. Neil Leach, is also a founding member of Digital Futures, with Philip Yuan of Tongji University, Shanghai. The platform brings scholars and practitioners from all parts of the world to present their work and discuss ideas with each other in a weekly online forum available free to all, both in real time on Youtube and recorded for later access. Their mission is "to cultivate a culture of inclusion and connectedness through the free sharing of knowledge and computational design ideas." (<https://www.digitalfutures.world>). FIU doctoral students participate directly in Digital Futures, particularly in special sessions organized by Leach, which address the topics of their classes. These lectures and discussions take place in a zoom format in which students can participate directly, and they are simultaneously broadcast to the web. The Digital Futures web platform has a global audience in the thousands, which is starting to be recognized by high profile designers and thinkers as a significant venue for discussing ideas. In this context FIU students are introduced to innovative architects and thinkers who are transforming the field and are invited to engage them in discussion. Currently a focus of discussion is the impact of machine learning and artificial intelligence on architecture and the possibilities that they will open for the field (Leach 2021).

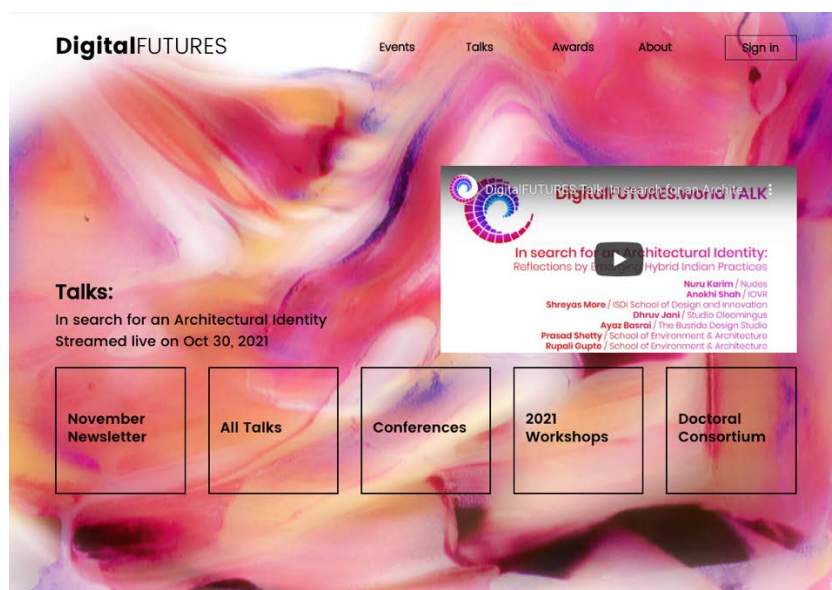

Figure 1: Digital Futures Website (downloaded, 11-21)

In addition to the online discussions, FIU offers a Robotics and Digital Fabrication Laboratory (RDF), which brings visualization technology to fabrication, using robotic arms, 3D scanners, laser cutters, programmable objects, and 3D printers for design, testing, prototyping, and construction (Figure 2). RDF is an extension of FIU's Integrated Computer Augmented Virtual Environment (I-CAVE), which is a fully immersive and interactive facility. The director of the lab, Dr. Shahin Vassigh, also has ongoing grant-funded research, which offers opportunities for research fellowships.

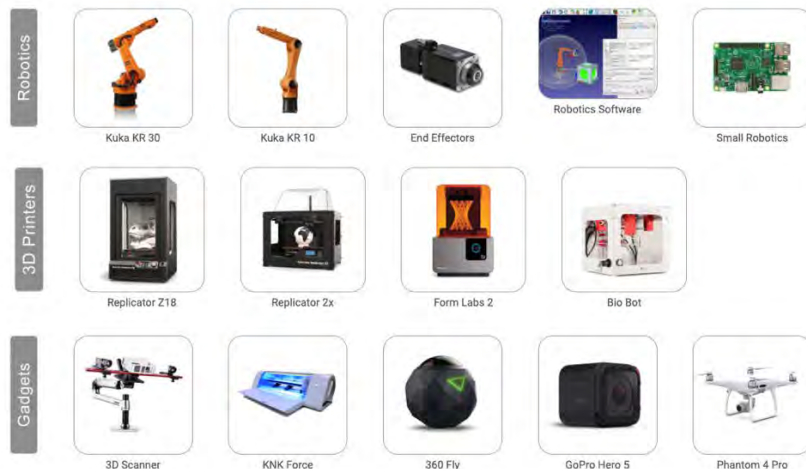

Figure 2: Robotic and Digital Fabrication Lab equipment (downloaded 11-21)

2. The Challenge of Sustainability and Resilience

The climate crisis requires a paradigm shift in architecture as in many fields, since continuing in the same direction will be disastrous. Innovative thinking is imperative, which builds on past work, but reinterprets it to construct new questions, both large philosophical questions about the role that humans might take to care for a damaged earth and smaller questions of strategy and technique.

Sustainability requires changing the ends for which architects design as well as the education they need (Keller and Main 2020). Strategies for true sustainability define building performance in relation to interconnected natural and urban systems over time, challenging the modern goals of newness and completeness implicit in the profession that we inherited (Mattern 2021). From this point of view, the value of design is in the difference it can make in the health and well-being of both.

University's DDes program focuses on this issue, often taking Miami as a case study. The challenges that Miami faces in rising sea level and a car-dependent, suburban fabric with extreme differences in income are readily apparent and parallel to similar conditions in other cities around the world. A purely technological approach will not suffice. Again, doctoral students engage an ongoing discussion, this one taking place in the city and among scientists and researchers across the university as part of the FIU Institute of Environment. These discussions engage ecology, biology, hydrology, infrastructure, and policy. For example FIU doctoral student, Sara Pezeshk is designing a system of permeable concrete tiles to encourage sea grass growth by stabilizing the bay floor (Figure 3). Ana Zimbarg is investigating how buildings might support plantlife in the microclimates they create. The doctoral program gives students a context in which they might study the current situation deeply enough to see the complex relationships at play, both biological and built. Some also consider the historical circumstances that brought us here, and from that perspective engage architectural theory afresh.

CREST CACHe _ Arti Shoreline: Bio-Tile

Sara Pezeshk, Florida International University
Research Mentor: Shahin Vassigh, Piero R. Gardinali

Goals

- The objective is to find design solutions for the current erosion problem along the Miami's shoreline to prevent further disintegration of beaches, help mangrove restoration along the coastal area, and create an attractive habitat for different species.
- Using 3D printing technology and material system to design and fabricate a multipurpose manmade shoreline to not only slow down the corrosion on the coastline but also re-attract to habitat marine wildlife in the new modular structure.



Figure 1. Proposed Site at FIU BBC Campus

Research Methodology

- Development of several Parametric design schemes using new software, materials, and fabrication technologies, which have the potential to improve the environmental performance of current systems deployed at the shoreline.
- The project addresses the question of how well the proposed architectural design options are helping to raise awareness of marine and coastal environmental issues among the students attending university or any visitors come and interact with the design landscape.



Figure 2,3,4,& 5. Parametric Design using Rhino, Grasshopper plugin

Results

- A series of material and geometrical tests have been conducted in order to discover the possibilities and limitations during the early stage of design.
- The latest samples, is constructed as container that holds mangrove seeds along the shorelines.



Figure 6,7 & 8. Concrete and PLA Tiles at the Shoreline



speze001@fiu.edu

FIU Center for Aquatic Chemistry and Environment
NSF Center of Research Excellence in Science and Technology



<http://crestcache.fiu.edu>

This material is based upon work supported by the National Science Foundation under Grant No. HRD-1547798. This NSF Grant was awarded to Florida International University as part of the Centers of Research Excellence in Science and Technology (CREST) Program. Any opinions, findings, and conclusions or recommendations expressed in this material are those of the author(s) and do not necessarily reflect the views of the National Science Foundation.

Figure 3: Sara Pezeshk designed concrete tiles to stabilize bay floor and encourage sea grass growth. Her work was funded by NSF Crest grant, FIU Institute of Environment

The FIU Institute of Environment is deeply involved in local issues of sustainability, including research on the Everglades, a freshwater ecosystem essential to urban water supply, Biscayne Bay, which defines Miami, and coral reefs throughout the Caribbean basin. All three ecosystems are threatened most immediately by nutrient pollution and existentially by climate change. The Institute of Environment offers architects the opportunity to work collaboratively with scientists in the effort to preserve, enhance, and integrate these ecosystems into the city. The ability of architects to visualize data is already contributing to ecological research, for example DDes student Fernando Rodriguez developed a means to show patterns of nutrient flow over time from ongoing measurements taken in many areas in the Everglades (Figure 4). Images tied to data can help the public as well as scientists see the ecosystem at work and recognize problems that must be addressed.

This working relationship also has the potential to develop an innovative approach to design that starts from within an ecological system, rather than from outside. Design might be generated by the requirements of plants and animals in relation to each other, rather than an exclusively human program. Working with scientists, architects might imagine buildings designed from a deeper understanding of the ecological situation and might envision a city that truly sustainable. These speculative drawings might conjure an alternative future and a different way to live that supports rather than degrades natural ecosystems.

CREST CACHe: Everglades Educational Virtual Reality Experience
Fernando Rodriguez, Florida International University
Research Mentor: Shahin Vassigh

Goals:
Develop an educational virtual reality application utilizing collected data and turning it into a fully immersive VR experience:

- This VR experience will serve as an educational medium that will offer knowledge through interactive media.
- The application will host information on mangroves and their influence on the Everglades.
- Showing what is not normally seen by the human eye, the Everglades throughout the years and what goes on underground.
- The application will also display variances of mangroves from east to west, showing why and how they differ.





Research Methodology:

- This requires utilizing dynamic and procedurally generated vegetation models for use within the application and creating a user-friendly procedurally generated environment.
- Using photo textures from real mangrove trees to UV map and model them. Then readying these assets with wind displacements, and level of detail (LODs) variants.
- Within Unreal Engine HDRi textures, dynamic lighting, procedural foliage instancing and custom blueprints are used to generate the environment.
- A virtual reality UI is then used to allow user interaction during the experience.



Results:

- Currently the procedural environment has been created and can be manipulated based on user input.
- Several assets and materials used within the application have also been created.
- The collected data needs to be assessed to maintain a level of accuracy.
- Other modes and information still need to be applied/created.
- The user interface needs to work better and smoother based on users input.





FIU Center for Aquatic Chemistry and Environment
NSF Center of Research Excellence in Science and Technology

Frodri116@fiu.edu Crestcache.fiu.edu



This material is based upon work supported by the National Science Foundation under Grant No. HRD-1547798. This NSF Grant was awarded to Florida International University as part of the Centers of Research Excellence in Science and Technology (CREST) Program. Any opinions, findings, and conclusions or recommendations expressed in this material are those of the author(s) and do not necessarily reflect the views of the National Science Foundation.



Figure 4: Fernando Rodriguez developed a VR experience of the mangrove ecosystem of the Everglades.

Social equity is related to sustainability at many levels (Leach, Reyers et al. 2018). Solutions to climate change collected by the Drawdown collaborative include advancing global equity through health and education (<https://www.drawdown.org/sectors/health-and-education>). Doctoral studies can bring architecture into this conversation as well. Skills of research and of visualization can discover the history of under-represented groups and can imagine a more equitable future. The FIU program has the potential to develop a focus in this area through studies of Miami neighborhoods, which some faculty members are currently pursuing in collaboration with other disciplines in the University.

3. A Mix of Local and Remote Students Enriches the Program

In a doctoral program the most valuable skills that students learn are those of researchers in any field: the broad critical thinking to craft meaningful questions that build on previous work and address pressing issues in the world and to design research projects that are doable in a practical sense. However, if the limit of the program is to educate more effective technocrats, then we have failed. A doctoral education must develop the foundations for leadership.

Part of this effort is to create opportunities flexible enough for non-traditional doctoral students who are already advancing in their careers. In many fields, including Architecture, the profile of doctoral students increasingly includes beginning or mid-career professionals, who would like to pursue doctoral studies to enrich their research program within a career trajectory they have already developed. In many cases, those who would contribute the most to doctoral level conversation are employed either as professors or in high-level positions in the profession and cannot or choose not to attend a residential program.

The FIU DDes program offers an online option that allows students to continue in their jobs, while participating in synchronous zoom classes with others from across the globe. Each semester online students are invited to join local, in-residence students in short, intensive sessions in Miami where they come to present their work and engage the faculty and each other as a group. This mix of local and remote students enriches the program by drawing a range of contexts and experiences into the discussion. Students who live and work elsewhere often develop their doctoral

A New DDes Program in Architecture at Florida International University focusing on Technology and Sustainability

767

research programs in collaboration with researchers in their home cities on topics meaningful to their locale. This work enriches the program for other students and for faculty, continually bringing new ideas into the conversation. The Digital Futures platform also keeps the program fresh, both through presentations of innovative design work and through discussions with contemporary theorists.

Through Digital Futures, FIU students engage in the contemporary, scholarly conversation that is questioning and reinterpreting ideas in the present. A course in architectural philosophy taught by Dr. Leach and coordinated with Digital Futures approaches canonical readings critically. For example, specific readings in the course are the subject of discussions with contemporary theorists who challenge and reinterpret them in Digital Futures discussions broadcast on Youtube. Students join the zoom-room discussion in real time and/or continue the conversation after the presentation. The canon is discussed not as received truth, but for the intellectual perspective it brings to contemporary debate.

A doctoral degree is often a prerequisite for teaching and the teaching methods within the doctoral program can model effective strategies. Here, again, the field is in flux. Increasingly the role of professor has shifted away from being the universal authority or master, to that of a leader who organizes a process of exploratory learning. Architecture studios have always been open-ended, but other courses as well benefit from authentic experiences that call on students to frame questions as well as seek answers. The same skills that define doctoral research, inform teaching: Critical inquiry, research, creative synthesis, and intellectual resilience (Kivunja 2014).

Doctoral study can offer the opportunity to rethink teaching. A well-structured program has the potential to offer doctoral students teaching opportunities in which they have the latitude to try out pedagogical ideas and methods. A course or study-group might give students a place to develop, discuss, and compare their strategies, focusing on teaching skill. For some doctoral students the caldron of the classroom might become a focus of study that engages both theoretical ideas and the day-to-day practice of working with students of architecture. The FIU program has a structure in which new teachers are coached and mentored in their first years and aspires to institute a more collaborative system for doctoral students to learn pedagogy.

Doctoral education in architecture has the potential to lift the field as an academic pursuit with a point of view different from other fields. The physicality of architecture and landscape as well as architects' ability to envision possible futures creates a critical distance that architects use and could use more effectively to challenge and create theoretical discussions at a level appropriate to the existential challenges that we face.

FIU's doctoral program strives to offer an educational environment in which students can study both the theoretical discussion and the reality of the climate/technology situation. Through liaisons with Digital Futures and FIU Institute of Environment, it is positioned to offer architects an opportunity to focus on research and engage leaders in the field in direct discussion as well as to take advantage of facilities and interdisciplinary faculty expertise at the home campus in Miami. The program's goal is for doctoral students to become leaders with a clear eye to the global challenges we face as well as the potential we hold.

REFERENCES

- Keller, E. and K. L. Main (2020). "After the Flood: Water, Climate Crisis, and Architectural Imagination." *Journal of Architectural Education* 74(1): 126-128.
- Kivunja, C. (2014). "Do You Want Your Students to Be Job-Ready with 21st Century Skills? Change Pedagogies: A Pedagogical Paradigm Shift from Vygotskyian Social Constructivism to Critical Thinking, Problem Solving and Siemens' Digital Connectivism." *International Journal of Higher Education* 3(3): 81-91.
- Kivunja, C. (2014). "Innovative Pedagogies in Higher Education to Become Effective Teachers of 21st Century Skills: Unpacking the Learning and Innovations Skills Domain of the New Learning Paradigm " *International Journal of Higher Education* 3(4): 37-48.
- Leach, M., B. Reyers, X. Bai, E. S. Brondizio, C. Cook, S. Díaz, G. M. d. Espindola, M. Scobie, M. Stafford-Smith and S. M. Subramanian (2018). "Equity and sustainability in the Anthropocene: a social ecological systems perspective on their intertwined futures." *Global Sustainability* 1.
- Leach, N. (2021). *Architecture in the Age of Artificial Intelligence: An Introduction to AI for Architects*. London, Bloomsbury Visual Arts.
- Mattern, S. (2021). *A City is not a Computer*, Princeton University Press and Places Journal.

A Systematic Literature Review of Ph.D. in Design Dissertations: A Case Study at North Carolina State University

Jinoh Park¹, Yeobeom Yoon², Byungsoo Kim³

¹University of Arkansas, Fayetteville, AR

²Oak Ridge National Laboratory, Oak Ridge, TN

³Kansas State University, Manhattan, KS

ABSTRACT: This study reviews *North Carolina State University (NCSU)*'s Ph.D. in Design graduates' dissertations to investigate the institutional efforts towards interdisciplinarity in design research. The doctoral program has focused on the questions that transcend and unite the design disciplines since 1999. Also, to enhance the interdisciplinarity, the program was reorganized in 2004 from the two concentrations in Community Design and Information Design to no concentration with six research interest areas. Starting with the first graduate's dissertation in 2003, this study examines which disciplines, methods, and findings have been produced by reviewing the graduates' dissertations published in the past years. Through the contextual framework based on the systematic review methodology, this research consists of five phases. First, the authors framed the research objective and questions. Second, they collected 86 dissertations through the NCSU handbook on Ph.D. in Design. Third, the inclusion/exclusion criteria were set for the review of the collected dissertations. Fourth, eight categories, such as publication date, title, committee chair, and members' name, committee chair/members' departments/expertise, abstract, main areas of design influences of the dissertation research area, methodology, and methods, were developed to sort, summarize, and synthesize the collected data. Lastly, the collected data was quantitatively and qualitatively analyzed to understand the diversity of committee members involved in the dissertations, the main areas of design influences of the dissertation, and the used methodologies. The authors peer-reviewed and synthesized the reviewed and sorted dissertation features. The findings of this paper present the characteristics of the program graduates' dissertations, including the levels of diversity in disciplines of committee members, research areas, and research methodologies and methods. The structure and the results of this review can be applicable to similar research-based degree programs at other institutions.

KEYWORDS: Design education, Design research, Interdisciplinarity, Literature review, Design doctoral program

INTRODUCTION

This study explored the design doctoral program graduates' dissertations at *North Carolina State University (NCSU)*. There has been an increasing number of doctoral programs in Design since the first Ph.D. in Design program was established at the *Illinois Institute of Technology* in 1991 (Illinois Institute of Technology 2021). There are 26 design doctoral programs whose degree or concentration name includes the word "Design" (Park, J. and Rider, T. 2018). If this is expanded to include programs containing the words "Art, Architecture, Urban, Planning, and Environment," there are 57 doctoral programs being operated. As a part of this flow, *NCSU* opened a *Ph.D. in Design* program in 1999 and a *Doctor of Design* program in 2018. Initially, two concentrations were offered in the Ph.D. in Design program for interdisciplinary collaborations (Davis, M. 1998, 33). One is *Community and Environmental Design* concentration based on a collaboration between the departments of *Architecture* and *Landscape Architecture*. The other is *Information Design* concentration, which brings together faculty from the departments of *Graphic Design*, *Industrial Design*, *Computer Science*, *English*, *Communications*, and *Psychology*. However, the concentrations created through this interdisciplinary collaboration did not fully meet the needs of applicants to enter the program since the applicants have frequently framed their research interests in areas between specialized academic divisions. In 2004, the design doctoral program was restructured around areas of design influence, such as health and well-being, learning, sustainability, urban context, technology, and history/criticism. In this way, the program expanded opportunities for faculty collaboration within the design and across the university, and also attracted more talented students to apply (Davis, M. 2008, 78). This program has expanded its scope through internal and external collaborations in research fields such as energy and health in buildings and has also achieved positive funding outcomes. As a result of these institutional efforts, as of 2021, the program is officially covering seven areas of research: Design for Sustainability, Design for Health and Well-Being, Design and Technology, Design and the Urban Context, Design Methods, Design for Learning, and Design History and Criticism (NCSU College of Design 2021). Furthermore, in order to promote interdisciplinary

research, the program offers students the opportunity to invite committees from outside the College of Design (NCSU College of Design 2021, 32). What has been the result of these institutional efforts towards interdisciplinarity in design research? The focus of this study is to examine the results of these institutional efforts through graduation dissertations. This paper provides a review of the program's efforts and an opportunity to contemplate the future direction of this program.

1.0 METHODOLOGY

This study employs a systematic review methodology. The systematic review produces a reproducible summary of the results of the available literature on a particular subject (Linares-Espinós, E. et al. 2018, 505). Khan, K. S. et al. (2003, 118) outlined a structured approach to conducting a systematic review: 1) framing questions for a review, 2) identifying relevant work, 3) assessing the quality of studies, 4) summarizing the evidence, and 5) interpreting the findings. Using the definitions and research structures proposed by the aforementioned researchers, this study conducts a systematic review of the graduate dissertations of the design doctoral program in order to review the results of institutional efforts towards interdisciplinarity in design research. First, this research aims to understand 1) the diversity of committee chairs/members involved in the dissertations, 2) the explored research areas, and 3) the used methodology and research methods. In light of these research objectives, the following research questions were developed under the main research question "What have been the results of the institutional efforts towards interdisciplinarity in design research?"

- Q1. How have the committees from different disciplines involved in the reviewed dissertations?
- Q2. In what research areas have graduates of this program conducted research for their dissertations?
- Q3. In what manner did graduates of this program conduct their research for their dissertations?

Second, the graduate dissertations that are accessible online and the ones with links that are listed in the *NCSU handbook on Ph.D. in Design* (NCSU College of Design 2021, 53-63) were collected for this study. In accordance with the review objectives, not the entire content of graduate dissertations was reviewed, but their abstracts were reviewed and pertinent information to the review was collected. Third, in order to qualify for inclusion in the review, the abstracts of dissertations must have been produced under the guidance of a committee chair that is from *NCSU's* College of Design. In this research, documents that were not specified in the *NCSU handbook on Ph.D. in Design* were excluded. Fourth, characterization of the literature was set to be used in the summary of the collected information as follows. Eight categories were developed to collect the information related to the purpose of this study, such as: 1) publication date, 2) title, 3) committee chair and members' name, 4) committee chair/members' departments/expertise (e.g., Architecture, Graphic Design, Industrial Design, Landscape Architecture, Mechanical Engineering, Philosophy, Psychology, Statistics, and others), 5) abstract, 6) main areas of design influences of the dissertation research area (e.g., building sustainability, education, healthcare, urban/suburban planning, communication, and others), 7) methodology (i.e., qualitative, quantitative, or mixed methods), and 8) methods (e.g., survey, interview, case study, focus group, and others). Researchers looked for the information that fits into certain categories of the information in the abstract. If the information is not found, it is marked as Not Identified (NI). Lastly, after the data collection, the collected data was quantitatively analyzed to understand the diversity of committee members involved in the dissertations, the main areas of design influences of the dissertation, and used methodologies. Also, qualitative analysis was performed to synthesize the information gathered in the main areas of design influences of the dissertations (see section 2.2.3 Organized by research area to view the detail of the qualitative data analysis process).

2.0 FINDINGS

In accordance with the inclusion and exclusion criteria, 86 publications from 2003-2021 were reviewed. Based on the aforementioned methods, the data from the reviewed dissertations that could help answer the research questions were systematically reviewed and synthesized. As a result of the review, findings are presented in the following sections to answer the research questions. Based on the review, the committee members' involvement from different disciplines was identified as one of the support systems for dissertation studies. To have an in-depth understanding of the diversity of the committee members' disciplines helping for the dissertations, the discipline of the committee chairs and members were reviewed and analyzed in different perspectives and presented in the following sections 2.1 and 2.2. Also, the synthesized results of different areas of design influences of the dissertation are presented in section 2.3. Finally, the used research methods are summarized and presented in section 2.4.

2.1 Organized by the Discipline of the Committee Chairs and Members

The College of Design at NCSU has the school of Architecture, departments of "Art + Design," "Graphic Design + Industrial Design," and "Landscape Architecture and Environmental Planning," to which the doctoral program belongs, and advisors are affiliated with each of these departments or the school according to their academic backgrounds. The committee chairs who have supervised a total of 86 graduate dissertations come from four different academic backgrounds: Landscape Architecture (LA), Architecture (ARC), Graphic Design (GD), and Industrial Design (ID). Figure 1 shows the distributed number of dissertations depending on the discipline of the committee chairs. There were 35 dissertations (41% of total) in LA, followed by ARC, GD, and ID papers with 27 (31% of total), 12 (14% of total), and 12 dissertations (14% of total), respectively.

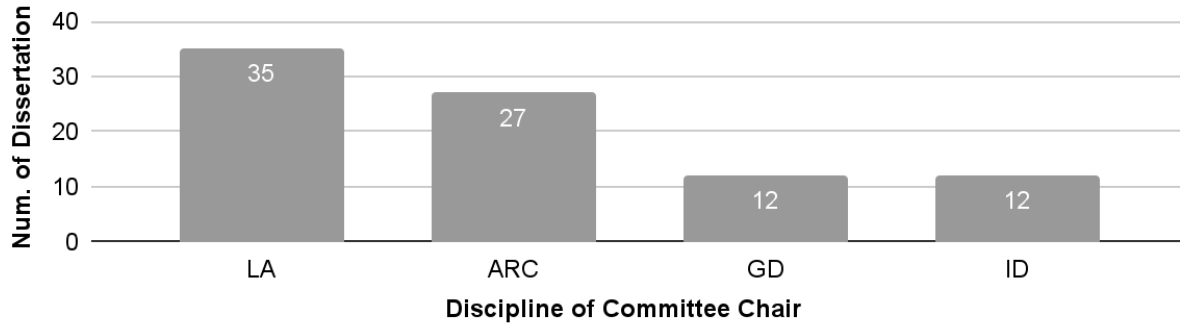

Figure 1: Distribution of dissertations by the disciplines of committee chairs.

There were 284 committee members on the 86 dissertations, excluding the committee chairs. Each dissertation committee consists of a minimum of three and a maximum of five members. Figure 2 shows the disciplines of the committee members. Those members of the committee who do not belong to a particular discipline of an institution, such as artists, were identified as experts. ARC had the most committee members with 49, followed by Psychology with 43, LA with 41, and Natural Resources with 27. In addition, the number of committee members came from the departments of GD (18), ID (16), Education (11), Mechanical Engineering (9), and Art+Design (6). The departments of the committee members in *etc.* category is as shown in Table 1. As a result, committee members with academic backgrounds in 38 different academic disciplines have been involved in the dissertations for this design doctoral program.

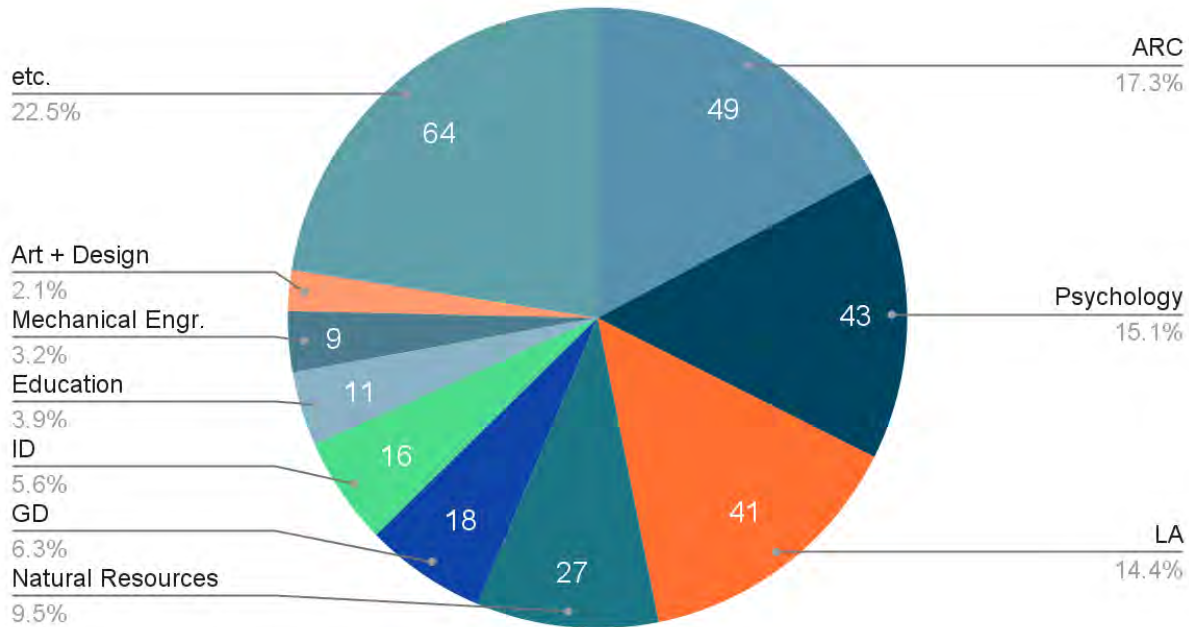

Figure 2: Distribution of disciplines among committee members

Table 1: Distribution of disciplines among committee members in *etc.* category.

Disciplines of committee members	Number	Disciplines of committee members	Number
Philosophy	5	Medicine	2
Sociology and Anthropology	5	Multidisciplinary Studies	2
Statistics	5	Social Science	2
Computer Science	4	Artist	1
English	4	Building Services	1

Public Health	4	Community Health	1
Anthropology	3	History	1
Extension and Engagement, College of Design	3	Human Environmental Sciences	1
Communication	3	Industrial and Systems Engineering	1
Health and Human Sciences	3	Interior Design	1
Adult Development/ Aging Specialist	2	Parks, Recreation and Tourism Management	1
City and Regional Planning	2	Political Science	1
Civil	2	Rhetoric and Technical Communication	1
Geospatial Analytics	2	Science Education	1

71 of the 284 committee members are from the same department as the committee chairs. Figure 3 shows the number of committee members affiliated with the same or a different department from the committee chair. There are a total of 123 committee members in the LA, 86 in the ARC, 39 in the ID, and 36 in the GD. As a result, 81% of the committee members of the dissertation related to GD were in different departments or expertise from GD, 77% of the committee members related to LA, 74% of the ones related to ID, and 70% of the ones related to ARC (lowest). There was an average of 75% of committee members from other departments than that of the committee chair, which indicates that the dissertation was conducted with the assistance of professors from a variety of departments.

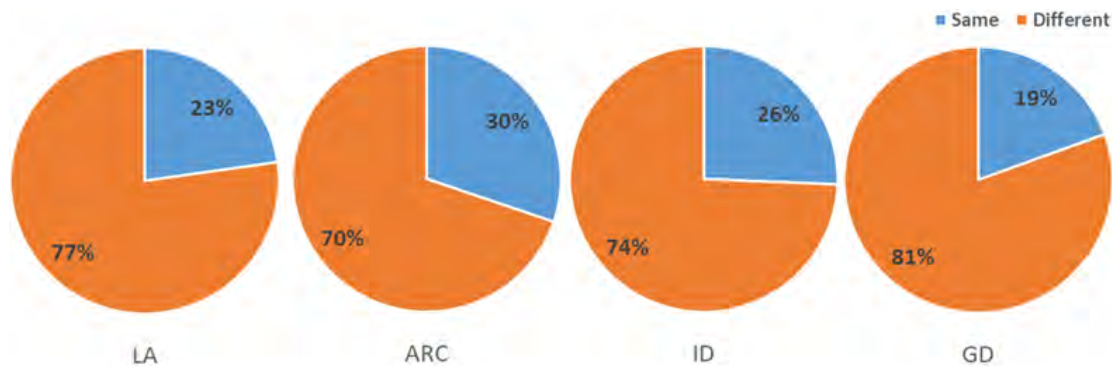

Figure 3: Distribution of committee members affiliated with the same or a different department from the committee chairs.

2.2 Organized by the Diversity of Disciplines of Committee Members

Each dissertation was supervised by four to seven members of the committee. The number of disciplines of committee members for each dissertation ranges from two to six. In other words, the dissertations cover overlapping areas of research in two to six disciplines. According to Table 2, 48% of dissertations were written under the guidance of committee members in three fields; 29% of the dissertations were written under the guidance of committee members

in four fields; 20% of the dissertations were written under the guidance of committee members in two fields; 2% of the dissertations were written under the guidance of committee members in five fields; 1% of the dissertations were written under the guidance of committee members in six fields. In conclusion, no dissertation was written under the guidance of only one field. Each dissertation was written under the guidance of at least two fields, 80% of the dissertations were written under the guidance of at least three committee members, and 32% were written under the guidance of committee members in four or more fields.

Looking at the diversity of the disciplines represented by committee members according to the discipline of each committee chair, 1) in the case of dissertations where the committee chair is in LA, the composition of the committee disciplines was between two and six, 2) in the case of dissertations where the committee chair is in ARC, the composition of the committee disciplines was between two and four, 3) in the case of dissertations where the committee chair is in ID, the composition of the committee disciplines was between two and five, and 4) in the case of dissertations where the committee chair is in GD, the composition of the committee disciplines was between four and five. The average number of disciplines of committee members occupying the highest percentage was three disciplines in the three cases of LA, ARC, and ID, and four disciplines in the case of GD.

Table 2: Diversity of disciplines of committee members.

Number of Disciplines of Committees		2	3	4	5	6	
Number of Dissertations (%)	Total	16 (19%)	42 (49%)	25 (29%)	2 (2%)	1 (1%)	
	Disciplines of Committee Chairs	LA	7 (20%)	15 (43%)	11 (31%)	1 (3%)	1 (3%)
		ARC	8 (30%)	12 (44%)	7 (26%)	0 (0%)	0 (0%)
		ID	1 (8%)	7 (58%)	3 (25%)	1 (8%)	0 (0%)
		GD	0 (0%)	0 (0%)	8 (67%)	4 (33%)	0 (0%)

2.3 Organized by Research Area

Thematic analysis was performed to synthesize qualitatively the information gathered in the main areas of design influences of the dissertations as follows. First, the abstract of the dissertations was reviewed by the researchers, and the main area of design influences of each dissertation was identified. After that, all the identified research areas were synthesized into the higher-level themes. There were two uncertainties when synthesizing the collected main areas of design influences of the dissertations into a higher-level theme. First, there were difficulties in combining multiple main areas of design influences of the dissertations into one theme. For instance, when there were studies dealing with urban planning and studies dealing with sub-urban planning, it was unclear whether each study should be divided into different themes, such as “urban planning” and “suburban planning.” Through discussions amongst all the researchers involved, a theme was developed taking into account the degree of subdivision of the entire field, and both of the studies were assigned to the “Urban/Suburban planning” theme. The other is when research can be assigned to multiple themes due to the characteristic of the research studies in the dissertation. In the case of building simulation research, for example, it can be assigned to technology and sustainability. In this case, we have identified 1) the output directly produced by the research findings through data collection and analysis and 2) the outcome expected from the output shown within this study (Frye, A. W. and Hemmer, P. A. 2012, 294). After that, amongst the identified outcomes and outputs, the main area that the dissertation contributed the most was selected through discussions amongst the researchers.

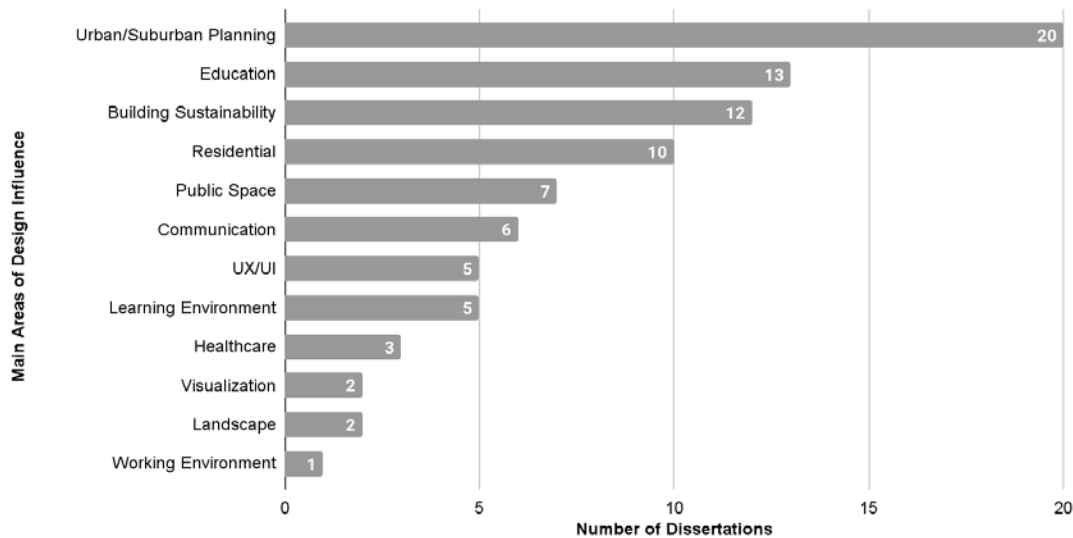

Figure 4: Distribution of 12 main areas of design influences of the reviewed dissertations.

Figure 4 shows the main areas of design influences of the dissertations. The title, keywords, and abstract of the dissertation have been reviewed to synthesize the main areas. Among all the different dissertation main areas, 10 main areas were synthesized and presented in Figure 4. 20 dissertations, among 86 dissertations, focused on urban/suburban planning, followed by education with 13, building sustainability with 12, and residential building-related dissertation with 10.

2.4 Organized by Research Methodologies and Methods

As the authors read the abstracts of the dissertations, the methodologies and methods specified by the abstracts were identified. Figure 5 shows the research methodology of the dissertations. In the 86 dissertations, 35 dissertations used mixed methods methodology, 24 used quantitative methodology, and 7 used qualitative methodology. 20 dissertations did not specify a research methodology in their abstract, which is publicly accessible.

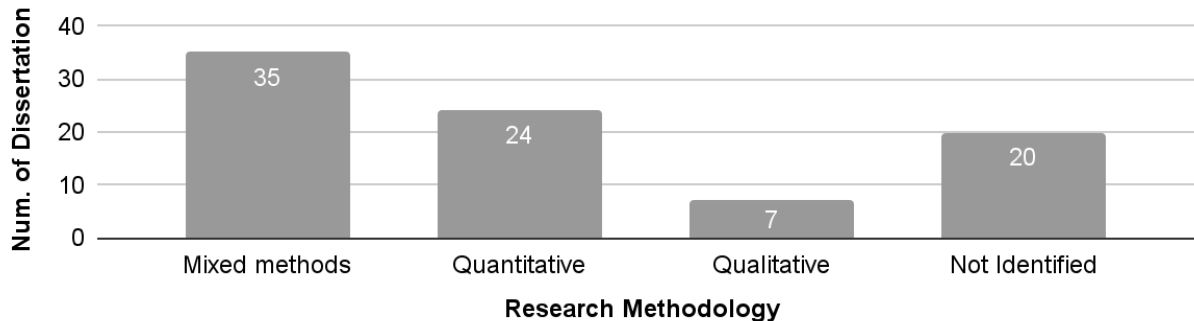

Figure 5: Distribution of research methodology of the reviewed dissertations.

Figure 6 illustrates the research methods described in the dissertations. Some dissertations incorporated multiple research methods so that there are 200 methods in 86 dissertations. Surveying was the most frequently used research method, and it was incorporated into 32 of 86 dissertations, or 37.2% of the total dissertations. In 26 dissertations, interviews were conducted, 21 dissertations used simulation programs, 19 dissertations used observation, and 15 dissertations used experimental studies. Research methods in etc. category are described in Table 3.

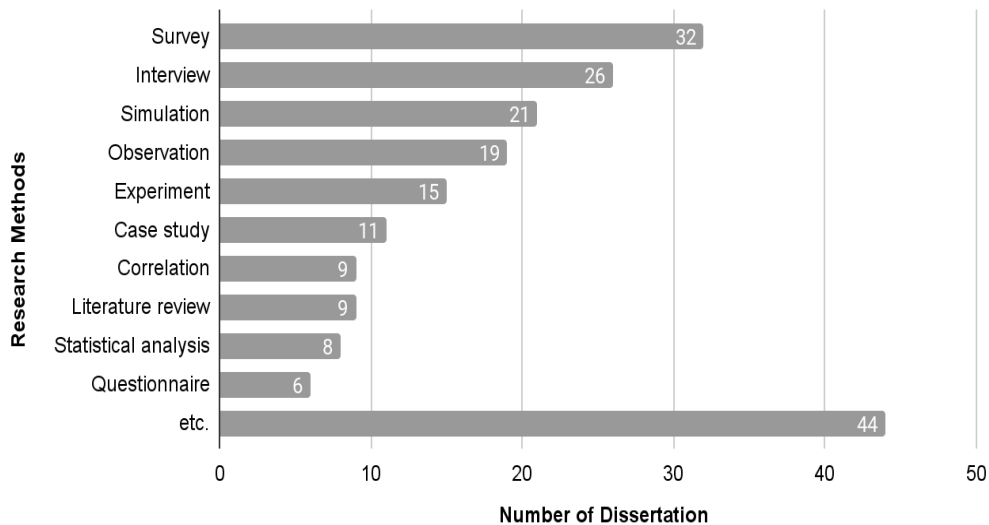

Figure 6: Distribution of the research methods used for the reviewed dissertations.

Table 3: Research methods in etc. category.

Research methods	Number of Dissertation	Research methods	Number of dissertation
Space syntax	4	Inductive open-coding	1
Focus group	3	Isovisits	1
Diary	3	Lived experience	1
Design intervention	2	Logical argumentation	1
Grounded theory	2	Phenomenology strategies	1

RESILIENT CITY
Physical, Social, and Economic Perspectives

Photograph	2	Rhetorical analysis	1
Behavior mapping	2	Role-playing	1
Multi-factor analysis	2	Theory driven methodology	1
Automatic text mining	1	Think aloud	1
Cognitive map	1	Traffic and collision analyses	1
Cognitive walkthrough	1	Urban network analysis	1
Conzenian morphology	1	Visual documentation	1
Critical Study	1	Virtual Reality	1
Discourse analysis	1	Measurement scale of place attachment and place identity	1
Drawings	1	Not identified	3

3.0 DISCUSSION

While this study investigated the Ph.D. in design Dissertation at a land grant university only, this review can contribute to architectural research in academia; such as utilizing the structure of the literature study and the findings to similar research-based degree programs at other institutions. The involvement of the committee members from diverse disciplines in the reviewed dissertations implies the importance of the cross-disciplinarity within/outside of the design college for the Ph.D. level Design dissertations. The findings from 2.1 and 2.2 show that NCSU encourages broadening interdisciplinary research at the Ph.D. level. The results suggest that, besides embracing the learning opportunities from the different design departments, active engagement with practitioners and professionals outside of the design college, such as in Psychology, Natural Resources, and Education, may receive the successful support for Ph.D. in Design students' dissertations. Diverse committee members' expertise could provide certain unique characteristics to the dissertations. Seeking the committee members suitable for the dissertation topic is generally initiated by the students' effort (bottom-up approach). Institutional level guidance on how research topic areas relate to related disciplines outside of the design field (top-down approach) might assist in finding appropriate committee members. A future study identifies the dissertations that involve the committee members from diverse disciplines and investigating the characteristics of the identified dissertations might help provide guidelines for the Ph.D. in Design students who plan to work on their dissertations that aim to be multidisciplinary. Identifying the committee members' disciplines in each dissertation and examining the relationship between the committee members' fields and the topic of the dissertation could also be an interesting follow-up study. This study has focused on the diversity of disciplines based on the analysis of dissertation abstracts. Other aspects of interdisciplinarity regarding the work of the dissertation, such as extensive time and effort devoted to building interdisciplinary knowledge, as well as the impact of the dissertation in different fields, are not considered in this study. More detailed and extensive reviews, such as reviewing citations of sources outside of the architectural/design discipline in dissertations and examining whether the dissertation is cited in journals outside of the architectural/design disciplines could be future investigation options.

In terms of the research area, many of the reviewed dissertations do not precisely fit into the seven research areas outlined on the Ph.D. in Design webpage (NCSU College of Design 2021). Instead, some aspects of one dissertation's research area can be classified into different categories. As an example, while one of the dissertations deals with "Design Methods," the main contributions of the dissertations had more to do with "Design and Technology" and "Design for Learning." This is likely caused by 1) the complexity of the topics that required interdisciplinary contributions and 2) the varied aspects of contributions regarding outcomes, outcomes, and targeted population. The categories developed in this study for grouping the main area of design influences in the reviewed dissertations are distinct from the seven categories in the previous study and could be of assistance in identifying the main areas of contribution. The developed categories will also be of assistance to Ph.D. in Design program directors in different universities interested in guiding their students in different research areas. As more dissertations with diverse topics will be published, the developed categories will need to be continuously updated. Also, instead of highlighting only one research area per dissertation topic, addressing the contribution of the dissertations in diverse areas considering different aspects, such as the main areas, minor areas, and target populations, might benefit Ph.D. in Design students in seeking the significance of their studies in different areas. Additionally, this will help to identify members of the committee from a variety of expertise, based upon the considered different aspects.

Various qualitative and quantitative research methods were used to collect data for the reviewed dissertations, as shown in Figure 4. Some methods are often paired together. For example, some of the experimental studies utilized the simulation method to ensure reliable research findings. On the other hand, there were dissertations in which simulation studies were performed to analyze sensitivity or conduct case studies while conducting experimental studies. Out of the 21 dissertations using the simulation method and 15 dissertations using the experimental method, 12 dissertations used both the simulation and experimental methods. The etc. category includes think-aloud, virtual reality, mapping, drawings, design intervention, grounded theory, critical study, and space syntax. The future analysis of the collected data to identify/categorize the research methods used in certain disciplines will be beneficial to teach research methods classes to doctoral students. This could mirror one of the previous study results, analysis to understand the dynamics of a combination of methods (Popper, R. 2008).

There are some limitations of this study and follow-up studies need to be conducted. While analyzing the results of the study by viewing different statistics and conducting thematic analysis were important steps in synthesizing the findings, a meta-analysis can generate new insights from the collected data. For this study, the data were collected from Ph.D. in Design dissertations from one university. The results of this study will be useful for a follow-up study collecting and analyzing the dissertations from similar Ph.D. in Design programs in similar universities, such as land grant universities, using the same research methodology. A study of the relationship between the degree of cross-disciplinarity in Ph.D. in Design dissertations and the implementation efforts for cross-disciplinarity on the curriculum and system level may be an interesting subject for future study.

4.0 CONCLUSION

Following is a summary of the results of institutional efforts towards interdisciplinarity in design research. There were 86 graduation dissertations completed under the supervision of 370 committee members in 51 disciplines. The dissertations were written under the supervision of 4 to 7 members of a committee in 2 to 6 different disciplines. The dissertations studied a total of 12 main areas affected by design. A total of 56 research methods were used to proceed with the dissertations. Considering that the results may indicate the nature of curriculum design and the extent of institutional guidance, the study may be useful to those in the field of education who want to understand the doctoral design program. For example, in developing research methods courses and organizing graduate faculty according to their research areas, committees of a newly emerging doctoral design program may refer to this paper as an initial benchmark. In addition, this paper contributes to the establishment of a study assessing the success of cultivating interdisciplinarity in design research through an American Ph.D. program in design.

REFERENCES

- Davis, M. 1998. *The New Ph.D. in Design at North Carolina State University*. The School of Design Carnegie Mellon University.
- Davis, M. 2008. *Why Do We Need Doctoral Study in Design?* International Journal of Design Illinois Institute of Technology 2021. *ACADEMIC CATALOG 2021-2022*. <http://bulletin.iit.edu/graduate/colleges/>
- Frye, A. W. and Hemmer, P. A. 2012. *Program evaluation models and related theories: AMEE Guide No. 67*. Medical Teacher, 34(5). <https://doi.org/10.3109/0142159X.2012.668637>
- Khan, K. S., Kunz, R., Kleijnen, J., and Antes, G. 2003. *Five steps to conducting a systematic review*. Journal of the Royal Society of Medicine, 96(3), 118–121. <https://doi.org/10.1258/jrsm.96.3.118>
- Linares-Espinós, E., Hernández, V., Domínguez-Escrig, J. L., Fernández-Pello, S., Hevia, V., Mayor, J., Padilla-Fernández, B., and Ribal, M. J. 2018. *Methodology of a systematic review*. Actas Urológicas Españolas (English Edition), 42(8), 499–506. <https://doi.org/10.1016/J.ACUROE.2018.07.002>
- Popper, R., 2008. How are foresight methods selected?. *foresight*.
- NCSU College of Design 2021. *PhD in Design 2021-2022 Program Handbook For Students and Faculty*. North Carolina State University. <https://academics.design.ncsu.edu/departments/wp-content/uploads/2021/08/phd-handbook-21-22-web.pdf>
- NCSU College of Design 2021. *PhD Research Areas*. <https://academics.design.ncsu.edu/departments/academics/phd-in-design/research/>
- Park, J. and Rider, T. 2018. *Exploring the Implementation and Outcomes of Doctorate Programs in Design in the U.S.* Proceedings of Conference for 49th Environmental Design Research Association (EDRA), June 6-9, 2018, Oklahoma City, Oklahoma, USA

The ACP Project: Focus Groups, Interviews + Ethnographic Research

Andrew Chin¹

¹Florida A&M University, Tallahassee, FL

ABSTRACT: The Apalachicola Cultural Planning (ACP) Project is a 3-year initiative that uses qualitative research methods to create a landscape of inclusion. The ACP will recover local Black history and culture; support the economic development of the historic African American neighborhood called "the Hill,"; and engage residents toward developing a permanent home for regional Black culture and history. The first step in meeting the three (3) goals was documenting a more inclusive history. Apalachicola, FL, is often defined as a source of fresh seafood and a symbol of "Old Florida" heritage. Both are true; however, the "Old Florida" tourism practices selectively highlight sites of racist power and ignore the history and contributions of its African American community -- "the Hill." Therefore, three types of qualitative research methods, focus groups, in-depth personal interviews, and ethnographic research, were used in the first year. The results of qualitative methods were descriptive, and we drew inferences from the data. The researchers initially hosted focus groups of Hill neighborhood residents at the Holy Family Senior Center. A year later, the researchers organized focus groups at a Pop-Up Museum. The aim was to find answers to the "why," "what," and "how" questions. During the community's annual African American Festival, graduate students gathered in-depth personal interviews. The team also created a Pop-Up Museum that included an oral history booth. The discussions were a conversational method that invited opportunities to get in-depth details from the community. The African American Festival provided an opportunity for ethnographic research that studied the community in its naturally occurring environment. It helped the team understand the community's cultures, challenges, and motivations. Instead of relying on interviews and discussions, we experienced the environment firsthand. Initially funded by a State of Florida grant, an Andrew Mellon Foundation grant will support the ACP Project's future work.

Sensitivity Analysis and Multi-Objective Optimization of Skylight Design in the Early Design Stage

Yuan Fang¹, Le Fan²

¹Western Kentucky University, Bowling Green, KY

²China Academy of Building Research Institute, Chengdu, CHINA

ABSTRACT: Building geometry design decisions play an important role in building energy efficiency and daylight performance, especially in the early design stage. Not enough studies have provided evidence that how building geometry variables are important compared to building materials and system design variables. This study focuses on the skylight design of a commercial building. Skylight is an important daylighting strategy; however, skylight to floor ratio is often the only design variable evaluated in precedent studies. This study proposes 18 design variables, including design variables related to skylight and clerestory window geometry, skylight materials, and building geometry. Three sensitivity analysis approaches, OAT, linear regression, and Morris methods are utilized to prioritize design variables according to their influence on the daylight and energy performance. 7 of the 12 building geometry variables and 2 of the 6 building material variables are considered as important. The top three variables are the side length of the skylights, the width of east and west windows, and window transmittance. Then a multi-objective optimization with genetic algorithms is processed to find out the optimal design solution with minimum energy loads and maximum daylight availability. After the optimization, six candidate design options are picked from the Pareto-front. Discussions are made on the features of these designs, and one design is selected as the optimal solution.

Florida Domestic Architecture in the 1940s: Economy House

Sarah Gurevitch¹, Dr. Vandana Baweja¹

¹University of Florida, Gainesville, FL

ABSTRACT: The 1940s proposals for the Economy House comprised two main strategies in their designs: reduction of the cost through mass-production and an increase in flexibility of homes for future expansion. The Second World War transformed Florida residential architecture in the 1940s through the development of new technologies like prefabrication, material innovations, increased industrial production, innovations in lighting, and improvement in thermal comfort design. These technological advancements combined with budget constraints and cultural shifts called for a national dialogue for the ideal postwar home. In planning a house within limited budgets, designers faced the tension between the mass-production and individualization of houses. Thus, the planning of the 1940s Economy House would address the competing requirements of standardization and customization. Florida architects in the 1940s tried to create livability at a tower cost. Due to the high building costs in the postwar years, architects approached design with economic and civic responsibility, which resulted in maximum and efficient use of space within the constraints of prefabrication. Architects proposed cutting costs through-outdoor living, modular planning, prefabrication, use of prefinished materials, and the use of new materials developed during wartime. Socio-cultural shifts after the war increased leisure time, which transformed the living room to serve multiple recreational functions that ranged from informal family living to formal hosting of guests. The use of new materials, advanced acoustics and lighting, and better articulation of space made it possible to design multipurpose living rooms. Higher levels of efficiency through mechanization were achieved in the economy house and with that, the house was standardized and mass-produced as one single unit. The 1940s Florida Economy House was a single-story house with room beneath for storage, and an open plan that allowed for expansion and adjustable space.

Modeling Healthfulness

Ulysses Sean Vance¹

¹Temple University, Philadelphia, PA

ABSTRACT: Whether static or dynamic, modeling is a critical instrument in reasoning adjacencies when designing for health. Healthfulness is "the quality of promoting good health" and is valuable to this study because it frames the challenges in resolving stressful conditions. In applying dynamic modeling techniques to healthcare and health information services, the primary concerns in this research focused on chronicling movement in a program and the differences in exterior spaces dedicated to patients versus providers as places to relieve stress. Open-air spaces in medical institutions provide an environmental release for patients and caregivers and help provide a healthful medical experience. By chronicling the movement patterns providers, the research examined types of isolation providers encountered, and using human-centered design goals, evaluated the ability of persons to assemble and engage in stress relieving activities. Each design stage included assessing the types of conflict between patients, providers, and the general public when conditions served as public spaces across different healthcare types. The study utilized visual programming diagrams to analyze the effectiveness of architectural programming based on planning for changing needs and concerns of connecting patients, activities, and designated spaces. In addition, the study selected preferences based on the environmental culpability in creating environmental anxiety for a patient before arrival, during registration, during a procedure, during recovery, and upon checkout. The culmination of this research focused on designing shared interior and exterior conditions that distributed encounters between patient and provider and documenting the physical properties that counter asocial anxieties as rendered directly through architectural elements and urban strategies. The result of studio-based research proposed and evaluated the design of a health center that produces a palatable "bedside manner" and provides healthful experiences.

Accessory Carbon Units

Rob Williams¹

¹University of Massachusetts, Amherst, MA

ABSTRACT: There is expanding discussion about the potential for Accessory Dwelling Units (ADUs) to address a host of housing issues: general housing shortages, housing affordability, the “missing middle”, and transitional housing. However, less attention has been paid to the role ADUs could play in broader efforts towards de-carbonization in the residential sector. Given their modest size, ADUs present unique opportunities to experiment with low-carbon construction and carbon-negative housing. With the number of ADUs potentially being constructed in the next decade, carbon-negative ADUs could be a key tool for integrating carbon sinks into existing residential building fabric. This project explores this potential through the design of a modest, pre-fabricated, 2-story ADU for the Northeastern United States. De-signed by an architect in collaboration with a builder-developer, this ADU demonstrates the feasibility of achieving net-negative carbon buildings with readily available and relatively traditional materials and methods. The schematic design is optimized to take advantage of recent revisions to local ordinances in a number of rural and suburban towns in Massachusetts. The 2-story scheme maximizes the interior conditioned floor area while minimizing the footprint in order to increase the number of eligible sites. A beta version of the Building Emissions Accounting for Materials (BEAM) tool from Builders for Climate Ac-tion was used to evaluate the relative embodied carbon of a range of high-performance assemblies and then analyze this with respect to energy performance. The preferred critical assemblies rely on maximizing biogenic materials with negative embodied carbon while minimizing carbon intensive materials. The building is also designed to be net-zero with the inclusion of a small solar PV array. This prototype ADU is currently being market tested as a semi pre-fabricated building that could have significant adoption within the region and makes the case for the viability of residential buildings as net negative carbon sinks.

The Alternating Dock

Ana Tricarico Orosco^{1,2}

¹Louisiana State University, Baton Rouge, LA

²Florida A&M University, Tallahassee, FL

ABSTRACT: Being a “working coast,” Louisiana has the ability to be at the forefront of technological advancements, and of uncovering mysteries laying deep into the sea. Currently, the Louisiana Marine Consortium (LUMCON) does not have room for its population of scientists to grow, or even to host larger groups of students. The dilemma is that Cocodrie is a small town with only 35 inhabitants, located outside of the federal levee, but LUMCON needs to augment its capacity to serve as a reference and destination to Louisiana residents and marine scientists. The institution has the potential to instill a sense of adventure and connection with the ocean in a way that very few research institutions can. Imagining a future in which all land is covered by water, the Alternating Dock adds a harboring system around the perimeter of Defelice in which modular pods are attached to. Each pod, or assembly of pods, is adapted to generate energy, collect data, or expand the existing building program. The architectural intervention utilizes the existing hard edges around Defelice as the stage for growth in order to cause minimal disturbance to the surrounding wetland ecosystem. The design proposal creates a new space in which the proximity to water propels research forward, while engaging LUMCON’s visitors in the adventure of learning about the ocean.

Bio-Cities: Synthetic Biology and Architecture in Coastal Communities

Alfredo Andia¹

¹Florida International University, Miami, FL

ABSTRACT: Which kind of thinking do we need to redesign our coastal communities? All the recent IPCC and UNEP reports show that we are quickly arriving at points of no return in the warming of our planet. Carbon emission-reduction strategies will not save the planet. We can no longer think in making slight improvements on the way we build and transformed our planet during the industrial revolution. We are in a deep crisis of imagination! In a series of studios at Florida International University we propose that a new generation of imagination will surface as we merge the fields of Architecture and Synthetic Biology (SynBio). Since 2006, SynBio has been growing a factor of 10 per year, the fastest growing technology in human history. SynBio involves emerging techniques that allow us to design, edit, and engineer all kinds of living organisms. Today we can manufacture molecule by molecule: lab-grown meat, bio-grown leather, milk, wood, fuels, fragrances, fabrics, novel pharmaceuticals, COVID-19 vaccine, and even age-reversal techniques. In this project, we visualize a series of islands and buildings in the estuary of Biscayne Bay in Miami, which uses living matter to grow. Based on previous research on a gene circuitry that uses cyanobacteria that has the ability to precipitate calcite to solidify sand in days. We envision the growth of a series of islands over the shallow Biscayne Bay as a way to create a “living shoreline” for relocating populations from Miami threatened by sea-level rise. These growing territories will have increased soil pressure that will self-transform according to the levels of rising seas. The proposed system of islands works like atolls that will create defenses from currents and surges. Each project was developed from a study particular growth process and each design investigates what makes an organism develop its shape.

Deployable Pod: A Case Study of Applied Transformable Design Research

Rachel Dickey¹, Noushin Radnia¹

¹University of North Carolina at Charlotte, Charlotte, NC

ABSTRACT: This research involved development of a collection of scalable prototypes for the transformable design of reconfigurable space. Specifically, the research explores folding strategies that convert a simple push or pull over a collection of parts to cause change in size and shape. The application of the research later informed the design of a collapsible pod for physical distancing protocols in response to Covid-19. The first set of investigations sought to study change in shape by folding and collapsing and then unfolding and expanding. In these explorations, the team observed the behavior and transformation of folding operations. The variables included different folding patterns and the location and amount of applied force applied to each form. To establish a mutual understanding throughout the project between the relationship of folding and motion, the team recorded and cataloged findings based on the different folding patterns. The team studied each pattern in a relaxed state (the neutral position after application of directional force and compressed state (where deformation occurs during the application of directional force) then documented each type to evaluate the change in size as well as range of motion of the form. Likewise, the team produced a catalog of fabrication strategies including flexible nodes, integrated material flexure, and composite lamination strategies to provide a catalog of ways to increase in scale. In order to apply the lessons learned from the research to develop the design and application for a full-scale prototype of a Covid-19 pop-up pod. The Covid-19 Pop-Up Pod demonstrates an architectural application informed by the catalog of transformational designs and fabrication strategies within the context of the pandemic. The pod operates as a pop-up mobile working unit which provides a physical barrier for social distancing and protection in open spaces.

Revisiting Modernist Mass Housing: Residents as Active Agents of Change

Nadia Shah¹

¹Illinois Institute of Technology, Chicago, IL

ABSTRACT: This research examines the modernist approach of mid-20th century mass-housing projects against the backdrop of post-colonial nation building and the need for housing refugees through resettlement projects after World War II. In this epoch, most of the refugees were accommodated in newly decolonized nation states that were struggling to create their national identity as 'modern'. It was at this moment in history, when the West assumed the paternalistic role of development of the so-called 'Third World', the 'Global South' or the 'Underdeveloped Nations', that they defined what is 'modern' using Western standards of 'normalcy'. On board with this international development project, architecture's response was to 'generalize problems' and provide 'normative prescriptions' for solutions based on rational models. Modernist architecture engaged with the "concept of normalcy" for the formation of a modern society through spatial and physical organization. This research uses the case study of a post-World War II refugee resettlement project called Korangi Town located in Karachi, Pakistan. It presents the trajectory of late modernism, particularly in the work of Greek architect Constantinos Doxiadis, for solving the global housing crisis after the Second World War. The objective is to see how the new normalizing architecture and planning standards of the West were received in the non-Western culture. The case of Korangi Town reveals that residents of a locale may organize themselves along cultural and ethnic lines, deviating from implemented prescriptive and normative solutions. The changes that the residents made to their built environment in the past sixty years, through processes conceptualized as 'appropriation', 'adaptation' and 'expansion', are interpreted as signs of their active agency. The residents' agency emerged to reshape their built environs to meet their cultural and individual needs, but most of all their economic needs. These observations show that rather than being passive recipients of ready-made and prescriptive solutions, the residents were active agents in adjusting and adding to their home and neighborhood environment.

Toward a Zero Waste Campus

Julia Pokol¹ + Consultants: Gyorgy Alfoldi¹, Zsolt Vasaros¹

¹Budapest University of Technology and Economics, Budapest, Hungary

ABSTRACT: The study proposes a digital simulation-based workflow for assessing the energy performance of façade-integrated green walls to support the current practice of empirical knowledge-based intuitive design. The study focuses on "living walls," which are a specific type of green walls where the plant, substrate and structural support are directly integrated with the building wall. The thermal potential of vegetation-integrated walls varies with climate type and context requiring case-by-case assessment for informed decision making. Due to the complex biological properties of vegetation, building information modeling (BIM) or building energy performance simulation (BEPS) programs do not yet include specific assessment tools for green walls limiting the scope of the performance-based evaluation. Most studies on thermal benefits are experimental or mathematical model-based which are not suitable for architects and designers. Few studies used building simulation programs where various modeling techniques are self-developed by researchers due to the lack of dedicated simulation tools. These studies are rarely combined with digital design platforms such as BIM or 3D modeling. In this regard, within the limitations of the current simulation tools, this study adopts the 'Green-roof' module of the widely used simulation engine Energy-Plus based on previous studies as this plug-in includes plant properties. Then the impact of variable changes in a living wall such as plant leaf area index, substrates, moisture and façade design aspects such as ratio, placement, and orientation of the living wall in a design case. The aim is to incorporate scientific research findings with a digital design platform using BIM and BEPS programs together.

Personalizing Climate Change: Measuring and Adapting Sea Level Rise Perceptions

Leonard Yui¹

¹Roger Williams University, Bristol, RI

ABSTRACT: This project is an environmental art installation to help patrons physically experience and imagine future sea level rise (SLR) based on ecological land types commonly found in Rhode Island (RI). Latest research on SLR shows that RI and surrounding New England areas are estimated to experience upwards of 9' SLR by 2100 and increased storm surge frequencies. This project addresses a key challenge to educate the public about these largely invisible and changing measures of SLR. This is accomplished through a series of (5) 20' tall markers located in a wildlife conservation reserve in Warren, RI. Markers on the piers are positioned accurately to show the latest elevations and a planned digital interface will provide further details about changes in habitat and other climate change data. The project's construction and development also included Audubon staff and university students. Significant effort went into choosing local materials, foundation construction as well as finishing elements through digital application like Rhino and Grasshopper and CNC milling. The design also articulates moments for wildlife habitats like solitary bees and bird perches which repurposes the downed lumber for urban development to uses that also provide direct ecological values.

The Side-Yard House Model: Creating Green and Resilient Communities

Craig S. Griffen¹

¹Thomas Jefferson University, Philadelphia, PA

ABSTRACT: Our current multiple environmental, health and social crisis's have given pause to reflect on where we live; causing some to relocate to better conditions. As we anticipate a "return to normal", we should reconsider new forms of housing, from the city to the suburbs, that are healthier, more sustainable, and more resilient to inevitable future crises. The Side-Yard House Model emerged as a common typology from years of design/research into energy-efficient mass housing that can be applied and adapted to a range of urban to suburban planning scales. The common planning concept for all scales involves re-proportioning the lot from a front/backyard to a side-yard model home. This arrangement, similar to the Charleston House typology, creates a primary green space on the south side of the house. This side-yard becomes the focus of all occupied rooms and generates several sustainable functions by exposing the long southern façade/roof to the sun for passive solar heating, natural daylighting and PV power production. Combined with a highly-insulated, prefabricated envelope, this house increases its resiliency in case of power outage or extreme weather. The green space also reduces heat island effect, improves natural ventilation cooling and can serve as a place of refuge for future pandemics. Since the side-yard house requires re-proportioning of the traditional front/backyard lot shape, open sites are best, which range from urban vacant blocks or brownfields to suburban grey field sites. The side-yard house model's building and lot size can adapt to a range of contexts from lower-density suburban (LDS) to high density urban (HDU) so may present a better model for sustainable and resilient housing for a range of siting conditions.

Bio-Materials: Explorations Around Bacterial Cellulose

Mercedes Garcia-Holguera¹

¹University of Manitoba, Winnipeg, Canada

ABSTRACT: The BIOM_Lab, a recently founded research group at the University of Manitoba, works at the intersection of biology and design exploring theoretical constructs, using digital simulation tools and working on applied science experiments with biomaterials to advance architectural research and provide a transdisciplinary platform for students to investigate alternative design venues. The work presented here illustrates our exploration of bacterial cellulose (BC), a biofilm made of cellulose as a result of the symbiotic collaboration between bacteria and yeast. This biomaterial is hydrophilic and absorptive, it has antibacterial properties, is biodegradable and has great tensile strength. Most research so far has explored applications of BC in the textile industry, electronics, the food industry, or medical applications. However, there are fewer studies exploring its application in architectural environments and its potential for climate change adaptation and mitigation strategies. Our work with this and other biomaterials aims to optimize resource use in buildings and support local production and distribution of materials for Northern and remote communities. Research with biomaterials requires access to non-traditional facilities such as: (1) a wet lab for inoculation and manipulation of active biomaterials, (2) a temperature-controlled chamber for fermentation, growth and harvesting purposes, and (3) a dry-lab to handle inactive samples. Our work with BC includes experimentation with several drying and dyeing techniques, testing BC's adhesive and tensile properties, and studying its potential in three-dimensional structures. Preliminary results with BC are depicted below (Fig. 1-15) and are being explored for future development of panelling systems, folded, woven and tensile structures that will be grown and harvested locally, and produced at room temperature. Furthermore, speculation on alternative design methodologies that challenge current standards on buildings' life span and materials' durability will be theoretical ramifications of this applied research.

Rights, Sagacity + The Devil's Crop: Provocations in an Ethos of Design, Dissolution + Disarray

Brian R. Sinclair¹

¹University of Calgary + sinclairstudio, Inc., Calgary, Canada

ABSTRACT: Madness is pervasive, with few facets of existence untouched and many aspects upended. Peace, order and stability seem far removed from memory as we confront climate, health, economic and social emergencies that uproot values and upheave harmony. Nations grapple with serious troubles, from sustainability and supremacy to pandemics and politics, discovering conventional responses are neither effective nor appropriate. Into the mix arrives polarizations that disrupt, divide and destabilize countries and communities. Grasping said problems, and effectively reading landscapes of unrest, proves daunting and depressing. However, history illustrates that during unfathomable crises viable paths forward warrant innovation, resolve and resilience. Design presents one vehicle to deploy, to positive ends, to navigate beyond present predicaments. The current research operates from a design perspective, arguing creativity and innovation in problem solving proves viable vehicles for reimagining systems/societies. Reassessing values is predicated on the Universal Declaration of Human Rights, a document that delineates vital conditions due to all people living on our small planet. To negotiate the turbulent waters of global breakdown and social upheaval, research methods include critical analysis of literature, logical argumentation and case studies, including an annual graduate Architecture Human Rights Studio. An ability to shape one's character, to be capable of grasping context, and to be equipped to act on wicked challenges, are precursors to rethinking/rebuilding systems gone amuck. Discerning right from wrong seems germane to equations of rights. Arendt (1974) noted "If everybody always lies to you, the consequence is not that you believe the lies, but rather that nobody believes anything any longer." The paper examines human rights via higher education, using Architecture as an illustrative case, and proposes a framework for action -- highlighting values, self and world views as timely and essential ingredients for re-designing systems and societies in more suitable, sympathetic and sustainable ways.

Striving for a Common Goal: Coastal Resilience through Interdisciplinary Design

Jori Erdman¹, Tiffany Troxler²

¹James Madison University, Harrisonburg, VA

²Florida International University, Miami, FL

ABSTRACT: Initiated in the fall of 2020, the Coastal Estuarine Research Federation (CERF) 2021 Coastal Design Competition was positioned as a forward-facing initiative to inspire students and faculty across disciplines to work together in proposing design solutions and innovative strategies to make our coastal environments more resilient in the face of coastal impacts of climate change. Six multi-disciplinary teams with members from at least 10 different universities were selected to compete in the competition. Teams from Florida International University, Hampton University, Morgan State University, Penn State, University of Delaware and Virginia Tech initially participated in the competition with two teams dropping out at the end. With a site area in Hampton, Virginia, the Design Competition was also intended to complement CERF collaborations with local communities to problem-solve together around pressing challenges. The 2021 Coastal Design Competition focused on critical issues of coastal settlement, ecosystem restoration, flood protection and social equity, highlighting the capacity of faculty-led, transdisciplinary teams to solve coastal problems and respond to climate change. During the spring of 2021, teams had multiple opportunities to engage with community members and leaders through a series of sponsored webinars and online meetings. Despite the limitations imposed by travel restrictions, teams were able to connect and respond to residents. Team's final submissions included a written report as well as a live presentation to a jury. The work revealed various strategies addressing the impact of sea level rise on residential areas and structures including elevation of existing structures, policy proposals and planned retreat. While each team approached the project with a similar methodology, the questions they asked were unique and yielded different results. The teams also employed novel communication and data visualization techniques to picture the coast 50-100 years in the future. Competitions like this move resilience forward in ways that are productive and visionary.

The Scalability of Urban Agriculture: Chicago Case Studies

Kristin Jones¹

¹Illinois Institute of Technology, Chicago, IL

ABSTRACT: Urban agriculture has recently been posited as a means to increase a city's resilience. While working with Ludwig Hilberseimer on a vision for a more sustainable and resilient industrialized city— a decentralized, linear development model situated within the context of a productive living landscape— Alfred Caldwell stated that “small farms could solve mass poverty, mass unemployment and inflation— our great national disasters.” This paper takes Caldwell's vision of small farming— as an act of resistance and empowerment of the individual, aimed at large-scale social and environmental transformation— as a launching point to explore what can we learn from contemporary examples of urban agriculture. The paper identifies three distinct approaches to urban farming that are currently being employed in Chicago with the intention of extrapolating how they have been or can be scaled up to impact broader societal and/or environmental change. The cases were selected to address a range of farming practices and organizational types. In the cases selected, farming practices studied include conventional raised bed farming, aquaponics, and permaculture. Organizational perspectives represented include two large non-profit organizations, a local community group, and an individual entrepreneur. Each case was studied in terms of a) the distinct approach to farming technologies and practices, b) the corresponding development and implementation process to bring the project to fruition, c) how it assesses its transformational effect on individuals and its broader societal and/or environmental impact, and d) any perceived opportunities or barriers to growth and long-term success. The study identified distinct aims in these examples of urban agriculture, which translate to distinct means of assessing impacts based on differing definitions of success. By defining some of the characteristics, challenges and opportunities in urban agriculture today, this research points to a multi-faceted, multi-scalar framework for discourse on urban agriculture within resilient cities.

Tensegrity Knit Helix Tower: Light Weight Deployable Structure

Virginia Ellyn Melnyk^{1,2}

¹University of Michigan, Ann Arbor, MI

²Tongji University, Shanghai, China

ABSTRACT: The deployable knit tensegrity tower is a prototype an approach toward more light weight deployable structures. The design uses minimal materials, textiles and rods, held within tensegrity modules. The objective is to generate a large volumetric structure out of a small amount of materials. The structure also demonstrates quick deployability by a single maker which is easily assembled in a short period of time. The design method utilizes a process of physical to digital and back to physical fabrication and construction. Knit materials are heterogeneous and do not stretch equally in vertical or horizontal directions as well as a variation stress is distributed across the surface as the yarn of the knit is able to slide through the rows of loops to a stretched position. The study of small sample panels and models allows for the resulting information to be applied as the required forces in the 3D simulation for the larger prototype. Grasshopper Kangaroo are used in Rhino 3D to simulate forces and determine the final size of the design. This is also used to determine the number of courses and wales which need to be knit for each panel. As well as the specified sizes and proportions of the panels. The large panels required to be broken down into smaller sub-panel pieces due to the constraints the knitting machine being used to fabricate the material. The final design is made of 54 individually knit panels which were attached together and to the bent rods. The process of attaching these components only takes a few minutes and is done by a single person. The structure results in a volumetric structure which has spatially multiplied its material value. The final structure weights under 5 pounds and can be maneuvered and interacted with by users. Resultantly it is a soft structure which is able to shift, bend and transform when pushed on by visitors. Its structural validity allows it to always rebound to its equilibrium state, providing a form of responsiveness and transformation as features of its light weight design.

Experiencing the Vortex

Pari Riahi¹, Fey Thurber¹, Erica DeWitt¹, Cami Quinteros¹, Pieter Boersma¹
Adrian Carleton¹, Ali Sarvghad¹, Yahya Modarres-Sadeghi¹

¹University of Massachusetts Amherst, Amherst, MA

ABSTRACT: Many scientific disciplines study and mathematically model natural phenomena. Similarly, design disciplines, such as architecture, study natural phenomena as an abstract vehicle towards design. These models enrich scientists' and architects' understanding of a phenomenon and foster analysis and problem-solving in domains that work through speculative modes of inquiry. In this project, we investigate novel methods that can facilitate communication and collaboration between disciplines to create a multi-faceted method of approach for creative thinking, design intelligence, and production of knowledge that can be beneficial to our respective fields: Architecture, Computer Science, and Fluid Mechanics. We have focused on standard scientific visualizations of fluid mechanic phenomena and developed new, architectural visualizations that transfer the purely scientific data, to something tangible and inspiring for designers in a creative process. Throughout this project, we have produced drawings, videos, and models, as well as a virtual reality representation of the original fluid mechanics phenomenon. This body of evidence allows architects, scientists, and individuals from other disciplines to inhabit what is normally unexplored, sustaining creative thinking and design ideation. By documenting vortices that form in the wake of a structure, a widely observed and highly three-dimensional phenomenon in fluid mechanics, we have aimed at representing what is otherwise not observable with the naked eye. Creating 3D representations of these phenomena through digital drawings and simulated virtual reality allows us to engage with the potential of uncovering their hidden facts, thus enabling scientific, architectural, and ultimately novel hybrid discoveries.

Assessing Architectural Design Factors of Maternity Ward That Influence Quality of Health Care and Patient Outcomes at Queen Elizabeth Central Hospital in Blantyre, Malawi

Chris Harnish¹, Luis Gadama², Zayithwa Fabiano², Kayla Holston¹, Stephanie Catrambone¹

¹Thomas Jefferson University, Philadelphia, PA
²Kamuzu University of Health Sciences, Blantyre, Malawi

ABSTRACT: The objectives of this study were to: 1) describe the architectural design of the maternity ward at Queen Elizabeth Central Hospital (QECH) and 2) assess how the architectural design affects patient and health worker flow, male partner participation in labor, peripartum mental health, and patient privacy. Methodology: Maternal data were collected from 35 women who recently delivered via interviews and surveys. The interview assessed: (1) maternal perception of privacy and (2) maternal perspective of paternal/guardian involvement. Peripartum maternal mental health was assessed using validated assessments. Interview data were collected from 35 male partners to assess perception of involvement in labor and delivery. To assess staff efficiency and satisfaction, a total of 11 clinicians were surveyed (6 nurses and 5 physicians). Achieved Outcomes: Maternal data reveal the sample had a mean Edinburgh Post-Partum Depression Scale score of M=10.5 (SD=3.97), of which 15 indicated thoughts of self-harm. More than half were satisfied with thermal comfort (57%), air quality/odor (71%), acoustic quality (86%), and lighting (97%). Maternal perceptions of privacy satisfaction varied between the antenatal (60%), labor/delivery (57%), and postnatal wards (40%). Most maternal respondents (71%) reported favorably around male support during labor and delivery. Yet, when asked if they would feel comfortable having a male present, most said no (66%) citing privacy and cultural issues. Paternal data reveal most respondents (83%) wanted to be involved in their wives' labor and delivery. About half (49%) felt negatively about not being allowed in labor and delivery, stating they missed out on the birth of their child. Results from the clinician survey revealed low satisfaction with thermal comfort in winter (45.5%) and summer (27.3%). Most (90.9%) reported not being satisfied with air quality/odor and only a quarter (27.3%) were satisfied with the overall indoor experience.

The Renewal Design of Dong Timber Dwelling Based on Tas Software: The Case Study of Gaobu

Xiaoyun Liu¹

¹Politecnico di Milano, Milan, Italy

ABSTRACT: Many traditional Dong wooden houses are abandoned by villagers or have been built or updated with modern materials because of the lack of living comfort. Through some renewal design methods to improve the comfort of traditional Dong dwelling, it is helpful to protect and continue the unique dry-frame residential tradition in Dong people. Taking Gaobu Dong village in Tongdao Dong Autonomous County as an example, this paper selects a typical residential case and analyses it with Tas software. Because of the demand for villager's self-renewal in Dong settlements, this paper presents a new design scheme of passive renewal based on the test results of Tas software and analyses the change of comfort before and after the renewal design. As a result, the Indoor Comfort of the optimised residential buildings will be significantly improved in summer and winter, and the passive renewal methods are feasible and straightforward.

Design For Youth: Research in the Design Studio

Julia Robinson¹

¹University of Minnesota, Minneapolis, MN

ABSTRACT: The Design for Youth: Equity and Opportunity research project had three original project leaders from the County Department of Rehabilitation and Corrections, from an architectural firm and from the University's School of Architecture. In its last two years, the project incorporated a community consultant, and community project participants. The advanced undergraduate studio engaged in exploratory research about the juvenile detention system to develop a continuum or spectrum of care for youth that would include such issues as incarceration, correctional placement, and treatment for addiction and mental health. Informed by literature, speakers, videos, site visits, and community members on issues such as incarceration, mental health, treatment programs, after school activities, addiction, job training, parental and youth, the study evolved from the design of detention facilities to prevention of detention. The study of issues that affected youth, as well as the history, site and social characteristics of the neighborhood, formed the basis for design of a program and architecture to address the disparities. Student projects addressed the gaps in existing service. In the second part of the studio students designed, for example, facilities for after-school activities, job training and treatment facilities (art, music performance, sports), family services, childcare, restorative justice, business entrepreneurship, transition from detention, housing and services for youth experiencing homelessness, a youth-run restorative justice center and community centers for carpentry, music, sports and performance. The primary conclusions derive from the need to eliminate poverty, segregation and institutionalized racism in the neighborhood: 1) Replace youth detention with treatment for motivating problems; 2) Provide free after-school activities, job training, and childcare; and 3) Develop a continuum of care for families in their neighborhoods.

The Future of Food Production: Urban Farming Towards Food Self-Sufficiency

Camilo Cerro¹

¹American University of Sharjah, Sharjah, United Arab Emirates

ABSTRACT: The United Nations projects that the global population will increase from 7.9 billion people today, to around 9.7 billion by 2050 (UN, 2019). This trend is heightening fears that the world's food basket may run empty in the coming decades. Both agrobusiness and scholars alike assert that this scenario leads to doubling world food production by 2050 as the only solution. Feeding the planet will become one of humanities greatest challenges. Figuring out how we do this will be of paramount importance, because the present system of linear farming creates more environmental problems than those it solves. With this in mind, the methodology of our Study Abroad Studio (in the city of Barcelona) revolved around the interdependent relationship between *Macro* and *Micro* programs in the creation of an urban farm linked to a series of satellite sub-programs designed to develop circular sustainability. The students were assigned an urban site where they were asked to develop a vertical farm as a main program (*Macro*). And then, they were asked to come up with a series of satellite sub-programs (*Micro*) to function interdependently in tandem with the main program. The vertical farm had to explore food production around hydroponics, aquaponics, fungiculture and other food producing systems. Leaving the satellite sub-programs to create a circular economy around the production and waste of the main program. We spent 4 months visiting our site and the community around it, doing field work while also touring sustainable facilities all around Spain to help us inform the work we were producing in Studio. This studio was designed to address these issues while helping create agency and empower the participants to understand their responsibility as designers in the time of climate change. The paper will show their work and our process.

The Strange Sources of Brazil's Modern Architecture: The Neocolonial Style in the Centennial Exposition (1922)

Camila Miranda Feltrin¹, Maria Teresa Dias da Fonseca¹

¹Universidade do Porto, Porto, Portugal

ABSTRACT: The prelude for the proposed research came from interest in the ephemeral Brazilian pavilions in international expositions. Through deep research of national archives, we identified the International Exposition in Celebration of the Centennial of Brazil's Independence (1922) to be a fruitful field for investigation. What attracted our eyes to this event was the initiative to categorize the Brazilian architecture as modern, although it was not clear at the time. Those efforts arose from the discourse to affirm a national architectural style, one based on the colonial architecture *revival*. Another topic of interest for us was the battle to establish the architect profession in Brazil. The Exposition was the first event that the government placed architects in charge of. The objects of study for this doctoral thesis are the national pavilions of the 1922 Exposition and the architects in charge of those constructions. Those young architects were responsible for teaching architecture. They battled for the establishment of the architect's profession, and they were among the most reputable architects in the country during the 1920s. We intend to investigate the national pavilions through the designer's career, placing the constructions in the center of the path. Evaluating their previous and posterior works in relation to the Exposition, we were able to build a narrative that elucidates the actions taken by these professionals in the search for the desired modernity of Brazilian architecture. We were interested in understanding how the experience of designing the ephemeral pavilions influenced future projects of the architects involved. We concluded that what remained of this experience was the intention, of build a modern country. As we approach the second centenary of Brazilian independence (2022), this research is dedicated to all those interested in the history of Brazilian architecture and the architecture of national pavilions in the nation's first centenary.

Urban Design Mitigations: Considering COVID-19's Impact on Public Space

Deirdre Hennebury¹, Fernando Cirino²

¹University of Michigan, Ann Arbor, MI

²Independent Researcher, FMC Urban Design + Planning, Windsor, Canada

ABSTRACT: The COVID-19 pandemic and its resulting public health protocols have compelled a reimagining of how we use, share, and, ultimately, design public space. Emerging research indicates that this global health disaster has further exposed the structural vulnerabilities and frailties in our urban populations and is driving a purpose-driven recalibration of what the allied design fields can offer in ameliorating our urban streets, centers, and greenscapes. Specifically, how can designers (urban and architectural) capture and learn from new human-centered usage data to create viable, inclusive, and adaptable public spaces. With the unprecedented demand for remote work and its associated specialized spatial requirements combined with the need to reduce density in interior spaces, the public realm -- "the space between and within buildings that is publicly accessible, including streets, squares, forecourts, parks and open spaces" (London Plan, 2015) -- has emerged as a central tool in alleviating negative pandemic-induced health and social impacts. With traditional utilization and demand being redefined by a diverse population of community members and groups, businesses, health organizations and persons at risk, the role and function of public space has emerged as a key component of post pandemic design and community development. Strategies employed for personal, commercial and health requirements during the COVID crisis have revealed creative opportunities but gaps in the distribution and inclusivity of public space remain. Using public health and urban planning data, this research draws on a sampling of design case studies in cities representing a range of population sizes. The intention of this project is to begin identifying thoughtful strategies and successful design solutions that mitigate the harmful and restrictive impacts of COVID-19 while addressing inequities of design, distribution, and access.

Considering Health + Wellness Beyond Convention: Spirituality, Space and the Critical Case of Sufism

Nooshin Esmaeili¹, Brian R. Sinclair^{1, 2}

¹University of Calgary, Calgary, Canada

²sinclairstudio, Inc., Calgary, Canada

ABSTRACT: Over recent years the profession of Architecture has faced increasing pressure to attend to matters ahead of bricks and mortar, glass, and steel. While the materials are crucial to success in the design of our spaces and places, they alone are of course insufficient. Architecture is first and foremost about inhabitation and people -- we craft our buildings to facilitate activities, provide inspiration, instill security and, most critically, foster wellbeing. Considering pressing global crises, including epidemics and pandemics, architects are now accountable to society in our quest for improved quality of life. To such ends designers are considering research and evidence that can inform decisions, including across the spectrum of determinants of health. The present paper reviews such elements, and moves beyond the physical, the psychological, and the sociological to critically examine the potential for spiritual space to further health and wellness. Incorporating a literature review that crosses disciplinary boundaries, the research then deploys case study methods to analyze major Sufi Architecture projects, building arguments for linking place-making to holistic health. The case studies examine a range of factors that contribute to transcendence in space, including light, proportion, water, materials, and choreography, illustrating spaces that stir our minds and touch our souls offer positive dimensions to dwelling, healing and being. Sufism, as a unique form of spiritual practice, considers the interplay of the outer world (including Architecture), and the inner world (body-mind-spirit). Analysis of the extraordinary case studies are shaped into a framework for health + design, providing guidance to architects and environmental designers as they strive to create buildings and landscapes that rise above the pragmatic. In our complex world, where stress and disease are ever-present, the current research serves to illuminate new ways of seeing, thinking, and acting that bring the spiritual more meaningfully into our design strategies and solutions.

VR Gestural Modeling to Recapture the Human Body in Design

Sara Codarin¹, Karl Daubman¹

¹Lawrence Technological University, Southfield, MI

ABSTRACT: Since the arrival of the digital to design, the fear of losing the importance of the physical body continues to increase. However, as new VR technologies emerge, these tools can be deployed to recapture the importance of the human body through both input and output design workflows. New VR design tools create a direct connection between designers and what they draw because of an ability to capture bodily movements, gestures, and intentions. In *The Hand* by Frank Wilson, the author highlights the connection that results from the gestural organization through "cultivating intelligence" by "uniting, not divorcing, mind and body". The impact of the human body was the focus of the elective seminar "Digital Twins" offered at the undergraduate and graduate levels in Summer 2021. The seminars required no previous digital design or software experience foregrounding the intuitive nature of designing with the body and working in a VR collective space. The courses investigated the human body as a biomechanical constraint and aesthetic inspiration. Through a series of weekly assignments, students captured their gestures and bodily dimensions as three-dimensional geometric representations. The geometric outcomes resulted in negotiation between body constraints, ease of motion, mechanics, and affordances of form. Theoretical technical knowledge and history of the body in design were leveraged to design for the body with the body. Connections were made from the Renaissance to contemporary artists and designers focused on representations of the human body. Various precedents demonstrated that the evolution of technology resulted in new forms of representation. This way of working in VR aspires for inclusive, diverse, and custom ergonomic freedom instead of Fordist notions of standardized, uniform, and idealized dimensional constraints. This paper seeks to demonstrate the potential of a gesture-driven digital drawing and how this way of working might result in a more human-centered architectural discourse.

Building in the Digital Transformation: Translations from Design to Technological-Enabled Demountable Building

Sara Codarin¹, Karl Daubman¹, Emily Kutil¹, Kristen Dean¹

¹Lawrence Technological University, Southfield, MI

ABSTRACT: The Digital Transformation is a cultural and technological shift that involves multiple sectors. Higher education plays a fundamental role in the current context, as it prepares future professionals to leverage the potential of digital tools to enhance construction processes with intelligent workflows. Through a graduate design studio these tenets were foregrounded in a pedagogical strategy of learning-by-doing augmented by a synchronous digital feedback-loop, and in so doing became a tangible expression of the Digital Transformation. The paper discusses the teaching approach and design outcome of an architectural graduate design studio, undertaken within the framework of the Covid-19 pandemic. The course required the attendees to design and build a temporary pavilion, within a construction budget, that could be disassembled, transported, and displayed to different locations. The studio leveraged divergent thinking related to progressive precedent research. The knowledge converged into the generation of the final design outcome: a deployable shelter located in a campus courtyard. The proposal (a combination of metal scaffolding, timber platforms, and fabric wrapping) needed to consider social distancing measures for gatherings and pandemic safety during all phases of construction, fabrication, assembly, and demounting. The construction week resulted in a hybrid workspace between the people working physically on-site (not affected by travel bans or health accommodations) and those interacting remotely. Students working online supported the construction phases by providing digital construction drawings and fabrication instructions. Students on ground evaluated design choices through fabrication and assembly testing. Constant documentation of the building process allowed for instantaneous feedback and enabled design iterations informed by on-site validation. The experience of the design studio questions future possibilities to deploy collaborative hybrid workspaces to manage cooperation between professionals. This paper seeks to demonstrate the potential of digital technologies to enhance design processes and -when the digital continuum is interrupted - smart implementation.

Carbon-Positive, and Synthetic Biological Architecture Imaginations for Miami Greater Islands 2021-2100

Thomas Spiegelhalter¹

¹Florida International University, Miami, FL

ABSTRACT: The Miami Climate Resilient Urban Nexus Choices (CRUNCH) research for carbon-neutral city scenarios is a multi-disciplinary effort addressing the food, water, and energy sector. The Miami project analyses, codes, optimizes and tests AI-assisted synthetic biology workflows and bio-diverse carbon-positive city designs and green-blue infrastructural scenarios from now to 2100. All designs focus on strategies for coastal Miami to adapt to sea-level rise, hurricanes, displacements, and heatwaves. These environments are the most climate-vulnerable zones worldwide. We are on the verge of a revolution where the same design principles applied to the built environment can be applied to biology and nanotechnology. This contribution is a three-to-four year extended EU Horizon 2020 and EU Belmont sponsored research sequence of world conference contributions at the UIA in Rio 2021, Venice Biennale 2021 Italian Pavillion, GOP 29 in Glasgow, and many more, The entire traveling exhibition, videos, and publications have been developed in three years of research with over 120 graduate students and doctorates.

Indigeneity, Imagination, Equity + Design: Ethical Space and Complementary Ways of Knowing

Brian R. Sinclair¹

¹University of Calgary + sinclairstudio, Inc., Calgary, Canada

ABSTRACT: Understanding an evermore complicated world, and tackling horrendous problems, proves formidable, thorny and tangled. While design is well-positioned to tackle complexity, recent awareness of alternative ways of seeing raises concerns about narrow perspectives, limited voices and urgency to embrace plurality. In North America, over many centuries, the assumed primacy of 'newcomers' aggressively suppressed indigenous knowing. Turtle Island's First Peoples survived on the land over countless generations, holding reverence for nature and humility around their place in the system. With European arrival synergy was overturned in dramatic and destructive ways. Colonizers' views concerning man's dominion over nature, land as commodity, written word as definitive, and science as supreme, countered indigenous traditions. Collision of values, as history painfully illustrates, was irreconcilable and ripe for conflict. Today the planet and its people, regardless of place/predilection, are caught in quagmires of crises. Climate, health, social, and other emergencies underscore unsustainable trajectories of modern civilization. Recent events, including social unrest and a global pandemic, highlight the need to reconsider our interface with the environment and each other. Calls for inclusivity, empathy and open-mindedness underscore urgencies of reconsidering systems and overhauling structures. Understanding, acknowledging and applying indigenous knowledge affords opportunities to broaden toolsets and surmount calamities. The research acutely evaluates prevailing mindsets. Using critical analysis of literature, ethnographic tactics, and case studies, including Architecture studios and community-based projects addressing Aboriginal culture, the paper presents a model for Western Science and Indigenous Knowing to act in unison to problem-seek and problem-solve. Divergent peoples, different cultures and parallel systems need to reside together in Ethical Space. Ethical Space is a vital precursor to progressing conversations and reconciling disparity in seeing, thinking and acting. To realize greater justice, fairness, concordance, and amity, we must urgently design /deploy viable and efficacious strategies for turning around many elements of modern life.

Complexity Science-based Analysis of Sustainable Integrated Urban Districts

Anjanaa Devi Srikanth¹, Chirag Hablani¹, Benny Chin¹, Thomas Schroepfer¹

¹Singapore University of Technology and Design, Singapore

ABSTRACT: Sustainable integrated districts (SIDs) in Singapore serve as testing grounds for larger future urban developments. They are characterised as distinct mixed-use zones with active public spaces, efficient mobility systems and accessible biodiverse networks. This study presents an analytical framework for pedestrian connectivity within SIDs using a Complexity Science-based approach to understand actual space use. The case studied is the one-north planning subzone in Singapore that was envisioned as a vibrant science hub and business park with an integrated work-live-play-learn environment. The design intent of Zaha Hadid Architects' masterplan, inspired by the "spatial repertoire and morphology of natural landscape formations", suggests a spatially coherent network that prioritises pedestrian use, which remains to be seen in the built form. The study maps the publicly accessible spaces and buildings as nodes in spatial networks of two scales: the urban subzone scale and the architectural building scale. At the urban scale, the study investigates the walkability of the larger district. At the architectural scale, significant buildings and their contexts are selected to study the connectivity of local spaces. Insights on their connectivity will be derived by studying on-site human movement using micro-mobility sensors to detect activity patterns. The correlation between the resulting network measures of the spatial network and the outcomes from the empirical socio-spatial analyses will form a scientific basis for evaluating the vibrancy of a local built environment and existing connectivity. The research is conducted to develop a new multi-disciplinary methodology for spatial performance assessment using Complexity Science, with important implications for the practices of analysis and future explorations in urban planning and design as well as architecture.

Amphibian Typologies and the Urban Imaginary

Mona El Khafif¹, Darcy Engle¹

¹University of Virginia, Charlottesville, VA

ABSTRACT: In Virginia, 250,000 acres of land and 1,469 miles of roads lie less than five feet above the high tide line. Hampton Roads, including Norfolk, Hampton, Newport News, and Portsmouth, are the most vulnerable to these environmental fluctuations. The region is one of the world's largest natural harbors, the most northern ice-free port of the East Coast, and an important Naval Base. The area is further continually sinking up to 7.5 inches per century due to a bolide impact 35.5 million years ago, causing the sea level to rise faster than anywhere else in the US. These conditions have exacerbated the need to rethink the coastal territories, as 80% of the region's economy is derived from federal sources located in Hampton Roads. Industrial and military land use has contributed to the pollution of sensitive coastal zones. In this graduate research studio, UVA School of Architecture collaborated with Norfolk. With 90% artificially constructed land, Norfolk is trying to find sustainable ways to live with the water productively. Students were tasked to re-design and re-imagine these increasingly amphibian habitats to serve humans and non-humans through a multi-scalar and typological lens. After working on an operational analysis to identify repetitive site typologies in the watershed, students were asked to zoom into multiple site settings to understand the local impact of rising sea-level and temporal events while identifying related systems. The process continued from site analysis to a site inventory and the development of a design manual to address the transformation of multiple sites simultaneously through their temporality. The studio stressed the innovation of representations ranging from TV commentaries, storyboards, and annotated drawings to communicate to the public. The poster features exemplary projects located on FEMA buy-out sites, brownfield sites, publicly owned lands, and industrial and military areas.

RIVERGAN: Fluvial Landforms Generation Based on Physical Simulations and Generative Adversarial Network

Xun Liu¹, Runjia Tian²

¹University of Virginia, Charlottesville, VA

²Harvard University, Cambridge, MA

ABSTRACT: Physical Models and simulations are widely used in the field of landscape architecture to study the complex and nonlinear phenomenon which are difficult to be studied by numerical simulations. For example, physical sand tables are used to simulate the fluvial performance and morphology, such as braided and meandering river, delta formation, tidal zones, etc. However, the application of the physical simulation has limitations, such as the limited accessibility of physical devices, the sophisticated and costly setup, the time-consuming simulation process, the difficulty to determine a proper spatial and temporal scale, to prepare input data and to interpret output data. Thus, the physical models can only produce limited number of simulation results for each study, which significantly limited the use of the physical simulation and the designers' imagination as well. As for designers, the uncertainty and indeterminacy of the simulation are important in terms of understanding the complexity and dynamic process of hydromorphology. A prototyping tool which can produce a large number of possible scenarios for design inspiration is preferred over an accurate and predictive model. In this research, we take the simulation of fluvial landscape on the hydromorphological sand table as an example, to present a novel and alternative framework for faster, more accessible and iterative method for physical simulations for landscape designers. By using the methodological framework of Procedural Terrain Generation (PTG) with Generative Adversarial Network (GANs), we collected 500 pairs of mesh and texture data from Hydromorphological Sand Table for training a LightweightGAN model. The result 3D latent walk is visualized through a customized user interface and can be easily integrated into creative workflow by landscape designers. Thus, the aim of the project is to utilize the inherent uncertainty in GAN models to study the possibilities of the process and patterns produced by the hydromorphology table.

Re-Commissioning Land: Spatial and Temporal Urban Strategies for Coastal Territories

Mona El Khaffif¹, Ali Fard¹

¹University of Virginia, Charlottesville, VA

ABSTRACT: The Northeastern Seaboard is the oldest megaregion in the United States and is defined by its density and economic output, producing 20% of its GDP and housing 17% of its population on 2% of the land area. Changing patterns in global industrial development and the environmental and spatial degradation caused by expansive industrial expansions in the region has resulted in new forms of poorly utilized spaces. These underutilized lands require novel strategies that address the aftereffects of industrial exploitation in multiple ways and scales. In the context of planetary-scale sea-level rise, the location of these urban centers further requires a new multi-scalar, spatiotemporal, and cross-disciplinary approach to re-imagine their relationship to water and climatic events. Our research has adopted a telescopic watershed-scale analytical lens to understand rising sea levels as regionally expansive and spatially relational. This poster features a design research method applied to the Hampton Roads metropolitan region, which will serve as a prototype to explore a regional strategy. While there has been growing concern about the environmental resilience of the area over the past decades, many initiatives are local in scale. They are missing a larger regional multi-scalar framework. Re-Commissioning Land proposes a land assembly strategy that stitches together adjacent but disconnected parcels — including brownfields and Superfund sites, military and vacant lands, impervious surfaces such as parking lots and transportation corridors, as well as industrial zones, publicly held lands, and infrastructural right-of-way — to generate a catalog of high-potential sites. By re-commissioning these land resources, the research addresses watershed-scale environmental issues regarding water-related climate change impact and infrastructure's capacity to serve as a spatial agent.

Postcards from the Future: Climate Fiction as Architecture Pedagogy

Gabriel Kaprielian¹

¹Temple University, Philadelphia, PA

ABSTRACT: Students today are well aware of the issues climate change, social equity, and urban health pose on the cities they live in. It is one thing to know that cities consume 78 percent of the world's energy and produce more than 60 percent of annual GHG emissions and another to feel empowered as a designer of the built environment to effect change. How do we inspire students to feel they have the skills, agency, and critical thinking needed to tackle these pressing challenges? In "Ecological Urbanism," Mohsen Mostafavi states that "we need to view the fragility of the planet and its resources as an opportunity for speculative design innovations... [where] the problems confronting our cities and regions would then become opportunities to define a new approach." This paper describes a pedagogical approach in applied research to use climate fiction as a way to design for a changing world. In an interdisciplinary studio, students from across the country and around the world joined together in a virtual classroom to develop a plan for each of their home cities in the year 2100. Students were first tasked with creating a Psychogeographic Mapping and SWOT Analysis in the home city to analyze the past and present conditions. They then developed Postcards from the Future, creating written narratives and images of the city in 2100. Students then developed an Urban Design proposal by developing Stakeholder Characters studies, Resilience Strategies toolkit, and Chance Event cards. This approach to design development directed students to consider multiple perspectives and alternative scenarios of Climate Fictions through gamification in design. In conclusion, through this pedagogical process the student's futuristic designs were less about a deterministic sole-authored project, but rather a framework for designs that are inclusive of collaboration from diverse stakeholders and adaptive to changes over time.

Equitable Access to Building Construction Through Advancements in Open and Global Building Machine Technology

Elizabeth Andrzejewski¹, Marcus Shaffer¹, Esther Obonyo¹

¹Pennsylvania State University, State College, PA

ABSTRACT: On December 26th 2019, as the United Nations called for the “Implementation of the Right to Adequate Housing”, they attributed our global housing crisis to unequal access to housing, a dilemma caused by socioeconomic inequality rather than access to building materials. Currently, 1 billion people reside in informal settlements and more than 1.8 billion people globally lack adequate housing. This paper examines Open-Source building technologies, such as Open-Source Ecology’s rammed earth house, and prefabricated building systems of the past, such as Konrad Wachsmann and Walter Gropius’s *Packaged House System* as precedents toward articulating new solutions to housing. In an age where DIY culture and Open information are disrupting traditional structures of industrialized production, can the distribution of house-building technologies provide housing solutions to those in need? Proposed here is a model of a *universal building machine* (UBM) and an agenda for housing solutions driven by Open-Source building technologies. This UBM is an architectural machine capable of processing material, handling material, fabricating building components, and assembling these components. This machine is informed by *universal* principles of Konrad Wachsmann’s prefabricated systems and his 7-axis Location Orientation Manipulator (L.O.M.), developed with PhD students John Bollinger and Xaiver Mendoza. A UBM informed by Wachsmann’s principles, and current technological advancements, could deliver affordable housing by essentially putting a mobile production machine on site. While industrial-scale housing production is inaccessible to the masses due to cost, Open technological solutions assembled from standardized parts and distributed through Open-source frameworks could realistically give people access to building technologies. By promoting accessibility to advanced building technologies developed and designed to be distributed to people in need, we empower individuals to actively participate in the construction and maintenance of their own sustainable homes.

Deploy 2.0

Ana Morcillo Pallares¹, Jonathan Rule¹

¹University of Michigan, Ann Arbor, MI

ABSTRACT: Deploy 2.0 is a structure designed to mediate sun exposure, promote plant growth and draw attention to the medicinal plants at the Matthaei Botanical Gardens. The installation invites visitors to consider how design and architecture can aid in the environmental conditions of non-human inhabitants, the plants. In a time where there is a heightened awareness of the human impact on the environment, how can architectural practices alleviate and improve the spatial conditions for humans and non-humans alike? The installation presents a dynamic spatial canopy inspired by the structural prototypes of the Spanish architect Emilio Pérez Pinero (1935-1972). The colorful modular system can expand and contract, imitating the annual cycle of a deciduous tree. During the spring and summer, the structure blooms and provides shade through a colorful arrangement of structural and fabric elements. The canopy’s modular system allows for the density of the shade to be tuned to the needs of the plants. In addition, the structure facilitates a new sensorial experience in the garden creating a focal point and space for gathering. During the fall and winter months, the canopy collapses, allowing for maximum sunlight to reach the plants below. As a design/research exercise, the project’s dynamic, playful and sensorial presence encourages learning about the affordances of medicinal plants and lightweight deployable structures. In addition, it serves as a demonstration of principles for sustainability through passive systems and simple actions that promote environmental awareness.

The Role of Architecture in the Therapeutic Environment: The Case of the Maggie's Cancer Care Centre

Caterina Frisone¹

¹Oxford Brookes University, Oxford, ENGLAND

ABSTRACT: Founded on the belief that design is a form of care, the Maggie's Centre has attracted attention since 1996 for its ability to engender therapeutic effects in people with cancer. Its striking architecture based on a concise and emotional architectural brief in synergy with its psychological support program is what underlies its success. With reference to the ancient Greek healing temples, an example of holistic healthcare and integration between people and place, Maggie's brief is crucial to guide architects in reviving the human element, creating buildings where users feel valued, at home and included. To investigate what is in the Maggie's Centre that positively impacts users, the research aimed to: 1) identify the design methodology that generates the therapeutic effects reported by Maggie's users; 2) to extract the key element that identifies the Maggie's Centre as a therapeutic environment; 3) to critically evaluate the Maggie's Centre as a model to be applied to other healthcare facilities. By studying the unconventional design of each building and adopting a phenomenological ethnography within three centers, the methodological process revealed that human-centered design is essential to creating a space where people feel valued, at home and included. Offering an immersive experience, the open sensory architecture combined with the human element at the center of the support program generates a synergy between Maggie's staff and visitors, an environment of total sharing that identifies Maggie's Centres as therapeutic. In UK institutions that offer health services, this condition never occurs. In fact, there is no circumstance in which the 'staff room' is deliberately excluded from the design brief, thus preventing the staff from being able to segregate themselves from users. This crucial factor, which sets Maggie's apart from all other organizations, teaches us that design can generate a caring community that can be a model for other healthcare facilities.

BEST RESEARCH PAPER AND POSTER AWARDS

ARCC-EAAE 2022 INTERNATIONAL CONFERENCE

BEST RESEARCH PAPER AWARD

Critical Pedagogy and Public Interest Design: Transforming Architecture Design Education for Social Justice

Erika Zekos, University of Massachusetts Amherst

Honorable Mention

Evaluating the Circadian-Effectiveness of Light through Personal Light Exposure Measurement: An Initial Test Using a Low-Cost and Wearable Spectrometer in Home-Office

Armin Amirazar, Mona Azarbayjani, Maziyar Molavi, University of North Carolina at Charlotte

Discrimination and Design: Equity, Justice, and Architectural Education

J. Phillip Gruen, Washington State University

Building with Air: The Internet of Things (IoT) as a Pedagogical Tool for Design-Build Education

Nate Imai, Texas Tech University

BEST RESEARCH POSTER AWARD

Sensitivity Analysis and Multi-objective Optimization of Skylight in the Early Design Stage

Yuan Fang, Western Kentucky University and Le Fan, China Academy of Building Research Institute

Honorable Mention

Complexity Science-based Analysis of Sustainable Integrated Urban Districts

Anjanaa Devi Srikanth, Chirag Hablani, Benny Chin Wei Chien, Thomas Schroepfer, Singapore University of Technology and Design

Modeling Healthfulness

Ulysses Vance, Temple University